



**FREESTANDING
Post Office and
Mailbox**



2

Designs

Fits hoop sizes 6" x 10" and larger

THREAD LIST



Isacord Thread Colors

0015 White (2 spools)

*** Project instructions included after design list.**

Note: One spool of 1000 meter thread is adequate for the project unless otherwise noted.

DESIGNS

Note: Some designs in this collection may have been created using unique special stitches and/or techniques. To preserve design integrity when rescaling or rotating designs in your software, always rescale or rotate designs using the handles directly on-screen.

*Fabric Required

12423-01 Entry Front Wall FSA

Size Inches: Size mm: Stitch Count:
2.98 X 5.82 in. 75.69 X 147.83 mm 27,985 St.

- 1.Placement Stitch 0015
- 2.Cut Line and Tackdown 0015
- 3.Lace..... 0015

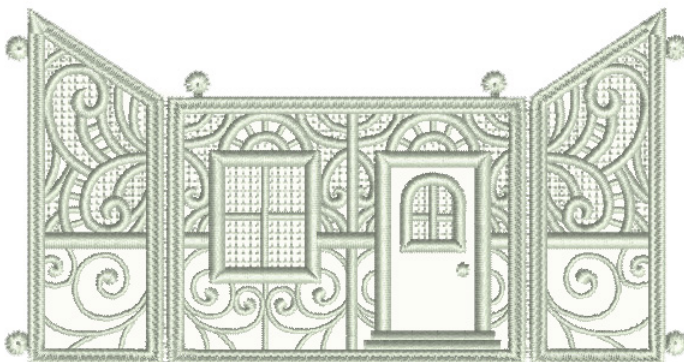

Note: Some designs in this collection may have been created using unique special stitches and/or techniques. To preserve design integrity when rescaling or rotating designs in your software, always rescale or rotate designs using the handles directly on-screen.

12423-02 American Flag FSL

Size Inches: Size mm: Stitch Count:
1.52 X 1.75 in. 38.61 X 44.45 mm 4,396 St.

- 1. Single Color Design..... 0015



***Fabric Required**

12423-03 Entry Front Roof FSA

Size Inches: Size mm: Stitch Count:
1.87 X 3.48 in. 47.5 X 88.39 mm 9,435 St.

- 1. Roof Placement Stitch..... 0015
- 2. Roof Cut Line and Tackdown 0015
- 3. Snow Placement Stitch 0015
- 4. Snow Cut Line and Tackdown 0015
- 5. Lace..... 0015

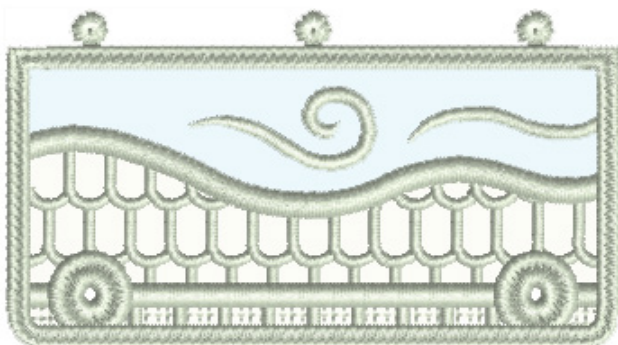

Note: Some designs in this collection may have been created using unique special stitches and/or techniques. To preserve design integrity when rescaling or rotating designs in your software, always rescale or rotate designs using the handles directly on-screen.

***Fabric Required**

12423-04 Front Wall FSA

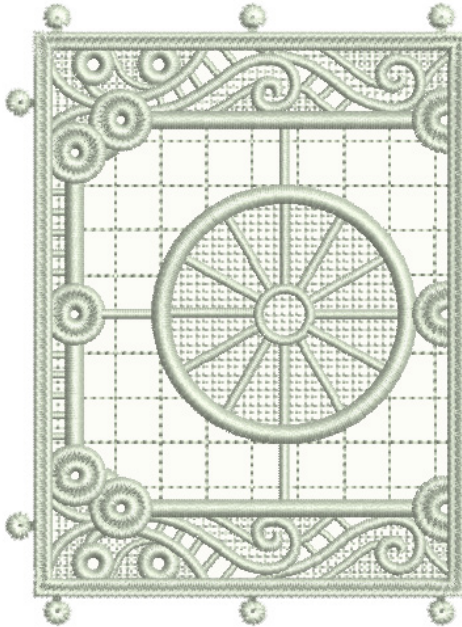

Size Inches: Size mm: Stitch Count:
3.51 X 4.86 in. 89.15 X 123.44 mm 24,676 St.

- 1.Placement Stitch 0015
- 2.Cut Line and Tackdown 0015
- 3.Lace..... 0015

***Fabric Required**

12423-05 Side Wall FSA

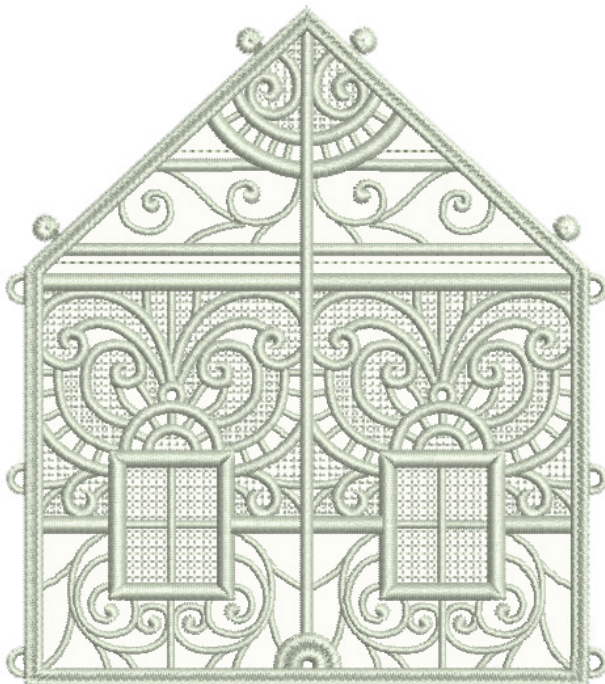

Size Inches: Size mm: Stitch Count:
4.59 X 5.33 in. 116.59 X 135.38 mm 35,979 St.

- 1.Placement Stitch 0015
- 2.Cut Line and Tackdown 0015
- 3.Lace..... 0015

Note: Some designs in this collection may have been created using unique special stitches and/or techniques. To preserve design integrity when rescaling or rotating designs in your software, always rescale or rotate designs using the handles directly on-screen.

***Fabric Required**

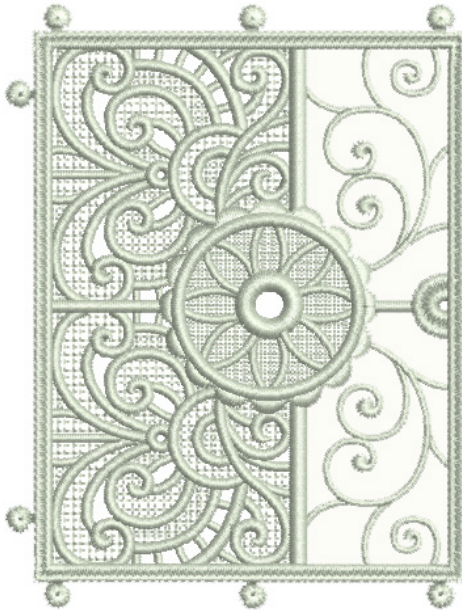

12423-06 Back Wall FSA

Size Inches: Size mm: Stitch Count:
3.51 X 4.73 in. 89.15 X 120.14 mm 29,218 St.

- 1.Placement Stitch 0015
- 2.Cut Line and Tackdown 0015
- 3.Lace..... 0015

***Fabric Required**



12423-07 Office Sign FSA

Size Inches: Size mm: Stitch Count:
3.94 X 1.58 in. 100.08 X 40.13 mm 6,725 St.

- 1.Placement Stitch 0015
- 2.Cut Line and Tackdown 0015
- 3.Lace..... 0015

Note: Some designs in this collection may have been created using unique special stitches and/or techniques. To preserve design integrity when rescaling or rotating designs in your software, always rescale or rotate designs using the handles directly on-screen.

***Fabric Required**

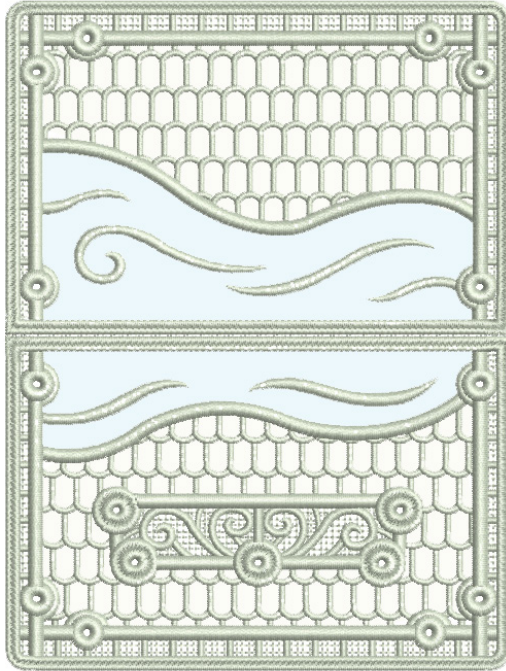

12423-08 Roof FSA

Size Inches: Size mm: Stitch Count:
4.9 X 6.67 in. 124.46 X 169.42 mm 50,303 St.

- 1. Roof Placement Stitch..... 0015
- 2. Roof Cut Line and Tackdown 0015
- 3. Snow Placement Stitch 0015
- 4. Snow Cut Line and Tackdown 0015
- 5. Lace..... 0015

***Fabric Required**

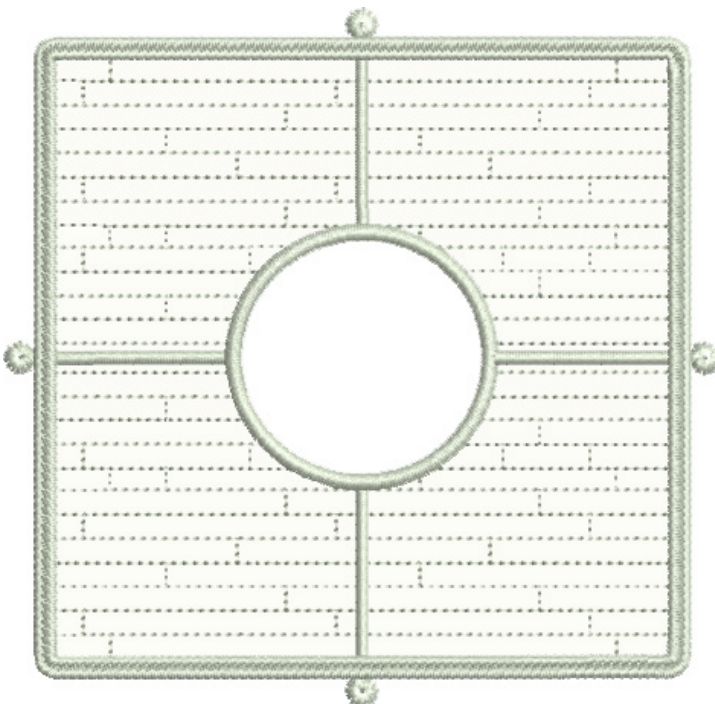

12423-09 Floor FSA

Size Inches: Size mm: Stitch Count:
4.7 X 4.7 in. 119.38 X 119.38 mm 12,218 St.

- 1. Placement Stitch 0015
- 2. Cut Line and Tackdown 0015
- 3. Lace..... 0015

Note: Some designs in this collection may have been created using unique special stitches and/or techniques. To preserve design integrity when rescaling or rotating designs in your software, always rescale or rotate designs using the handles directly on-screen.

12423-10 Mailbox FSL

Size Inches: Size mm: Stitch Count:
2.99 X 2.03 in. 75.95 X 51.56 mm 6,617 St.

1. Single Color Design..... 0015



Stabilizers

- OESD AquaMesh Plus WashAway
- OESD BadgeMaster WashAway
- OESD StabilStick CutAway

Fabrics/Textiles

- White cotton fabric 1/4 yard
- Note: Fabric sizes are estimates and may result in overage.

Notions & Tools

- OESD Alligator Clamps
- OESD Button Clips
- Expert Embroidery Tape WashAway
- OESD Perfect Embroidery Press Cloth
- OESD Perfect Point and Press Tool
- Embroidery Needle Sharp 75/11

Isacord Thread Colors

- Per thread chart
- Match bobbin thread to top thread
- 0015 White (2 spools)

SUMMARY



Completed Size: 5 1/4" Tall, 4 1/4" x 5 3/4"

12423-01

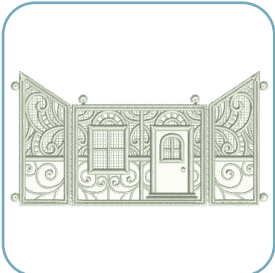

Requires 1 Design

12423-02



Requires 1 Design

12423-03



Requires 1 Design

12423-04

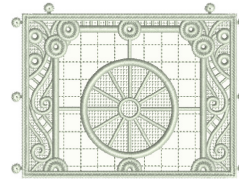

Requires 1 Design

12423-05

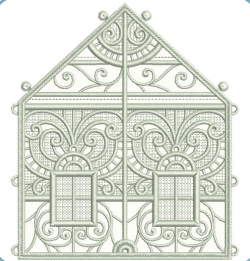

Requires 2 Designs

12423-06

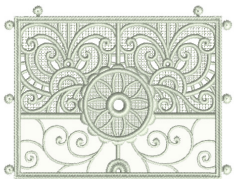

Requires 1 Design

12423-07



Requires 1 Design

12423-08

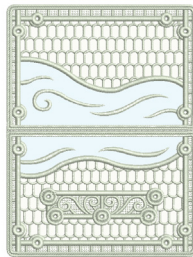

Requires 1 Design

12423-09

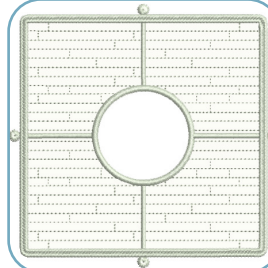

Requires 1 Design

12423-10



Requires 1 Design

Notes

The freestanding applique instructions, included in the collection, are general instructions. For demonstration purposes, a sample design that best demonstrates the technique is shown. Fabric and thread requirements will vary by design, but the general technique is the same.

All designs are stitched with matching thread in the top and bobbin.

For other designs in the collection, use the applique templates as a guide to the dimensions of the various applique pieces.

Note: Some thread colors in instructions have been changed or digitally enhanced for better visibility.

STEP 1

- Hoop one layer of AquaMesh and one layer of BadgeMaster for all designs.



STEP 2

- Adhere two layers of StabilStick CutAway to the wrong side of all applique fabrics, to provide stiffness to the finished structure.
- Cut the prepared applique fabrics 1/4"-1/2" larger than the applique templates.



EMBROIDERY



STEP 3

- Load selected design into the machine.
- Example design is 12423-05.
- Thread the machine per the thread chart.
- Place hoop on the machine.
- Stitch Machine Step 1, Placement Stitch.

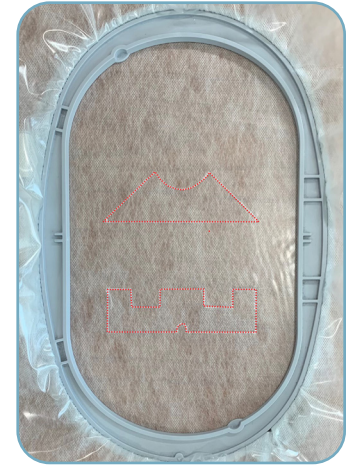

STEP 4

- Remove the hoop from the machine, but NOT the project from the hoop.
- Place the hoop on a flat surface.
- Place the prepared applique fabric, right side up, completely covering the placement stitch.
- Tape in place to secure.

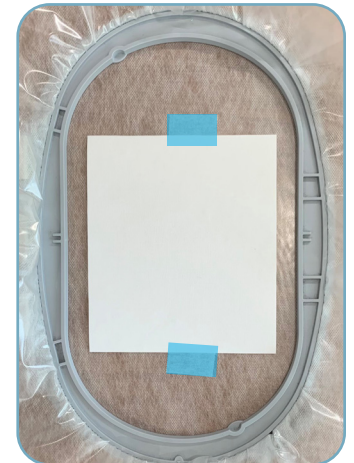

STEP 5

- Return the hoop to the machine.
- Stitch Machine Step 2, Cut Line and Tackdown.

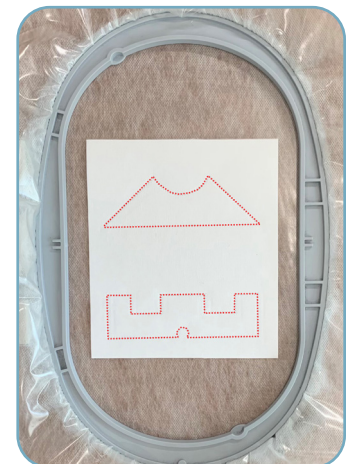

STEP 6

- Remove the hoop from the machine, but NOT the project from the hoop.
- Trim the excess fabric as close to the cut line stitching as possible.
- Note: If the outermost stitches (cut line) are cut, the inner stitches (tackdown) will still hold the applique in place.
- Tip: If the AquaMesh is cut or a hole is created while trimming the fabric, use OESD Expert Embroidery Tape WashAway as a patch.



STEP 7

- Return the hoop to the machine.
- Stitch Machine Step 3, Lace.
- Stitch the remaining machine steps, per thread chart.
- Match the bobbin thread to the upper thread.
- Note: Stitch all required designs. 12423-02 American Flag FSL and 12423-10 Mailbox FSL are freestanding lace only, fabric is not required.
- When the design is complete, remove the project from the hoop and trim the stabilizer 1/4" - 1/2" outside the design.



ASSEMBLY



STEP 8

- Rinse each piece in warm running water until the design is only slightly tacky.
- Place right side down on a non-stick surface to dry. Parchment paper or a cooling rack work well to prevent curling. Dry completely.
- Once dry, press right side down on a Perfect Embroidery Press Cloth.



STEP 9

- Fold the flaps of the Entry Front Wall FSA (12423-01) toward the back to create a shallow U shape.

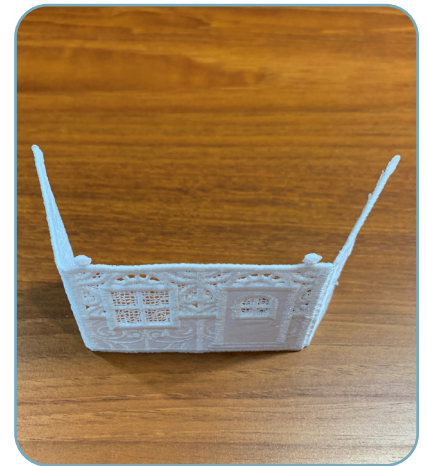

ASSEMBLY



STEP 10

- To create an extended entry, attach Entry Front Wall FSA (12423-01) to Front Wall FSA (12423-04) by pulling the four buttonettes on the front entry flaps into the four corresponding eyelets.

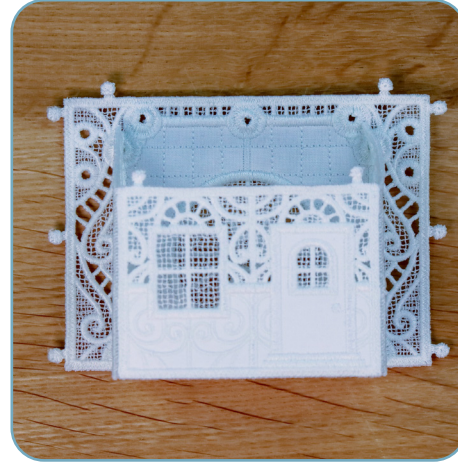
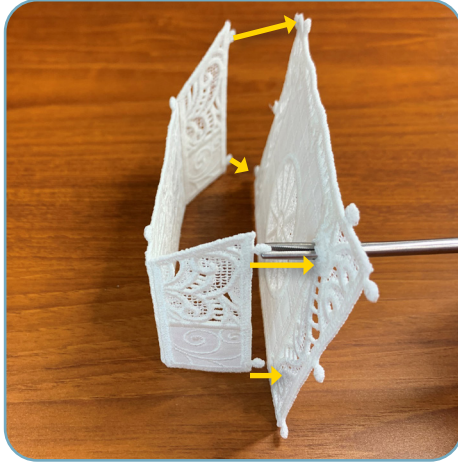

STEP 11

- Attach Front Roof FSA (12423-03) by pulling the three buttonettes on the roof into three eyelets on Front Wall FSA (12423-04) above the attached front entry.

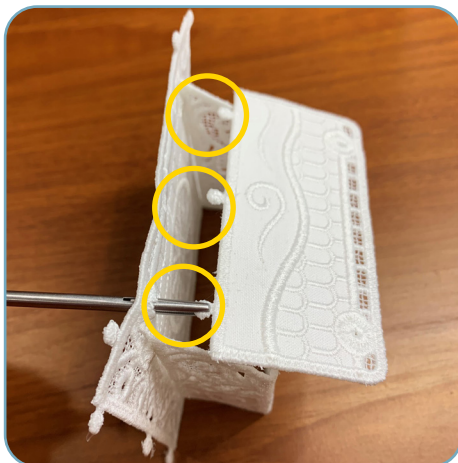

ASSEMBLY



STEP 12

- Complete the entry roof by pulling the two buttonettes on Front Wall FSA (12423-01) into the two eyelets at the front of Front Roof FSA (12423-03).

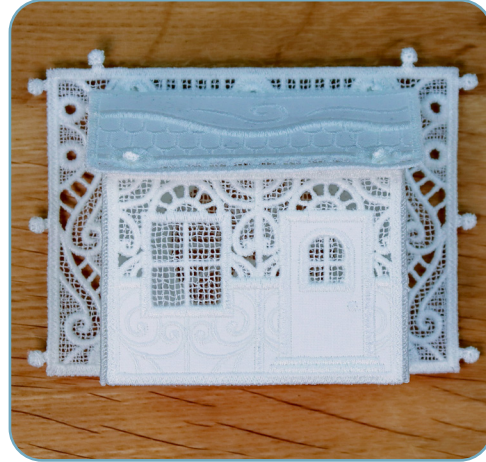
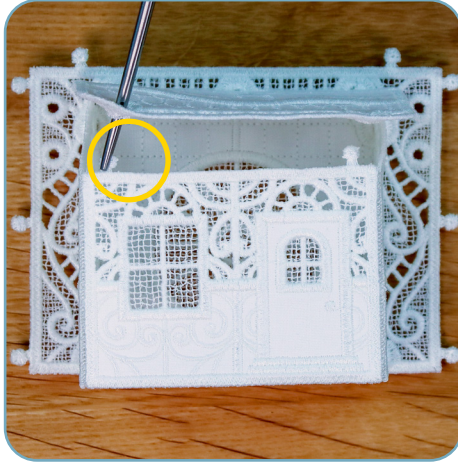

STEP 13

- Attach one Side Wall FSA (12423-05) to one side Front Wall FSA (12423-04) with extended entry by pulling the three buttonettes of the front wall into the three eyelets on the side wall.

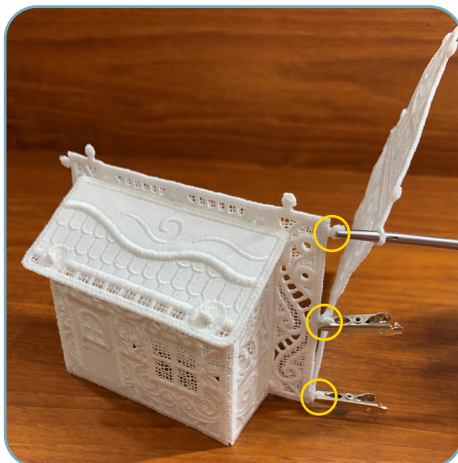

ASSEMBLY



STEP 14

- Repeat the above for the other side wall to the front wall.

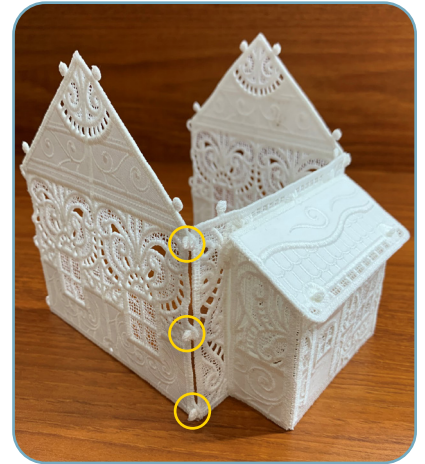

STEP 15

- Attach American Flag FSL (12423-02) to Front Wall FSA with extended entry (12423-04) by pulling the two buttonettes on the flag into the two eyelets.
- Note: The flag can be placed on either side.



ASSEMBLY



STEP 16

- Attach Back Wall FSA (12423-06) to each Side Wall FSA (12423-05) by pulling the three buttonettes of each side of the back wall into the three eyelets of each side wall.



STEP 17

- Fold the flaps of Sign FSA (12423-07) toward the back to create a U shape.



ASSEMBLY



STEP 18

- Attach Sign FSA (12423-07) to Roof FSA (12423-08) by pulling the five buttonettes along the sign into the five eyelets located around the square of lace in the roof.



STEP 19

- Attach Roof FSA (12423-08) to Front Wall FSA (12423-04) by pulling the two buttonettes from the front wall into the two eyelets along the front edge of the roof.
- Note: The sign will face the same direction as the extended entry.



ASSEMBLY



STEP 20

- Attach Roof FSA (12423-08) to each Side Wall FSA (12423-05) by pulling the four buttonettes into the corresponding eyelets along the side edges of the roof.

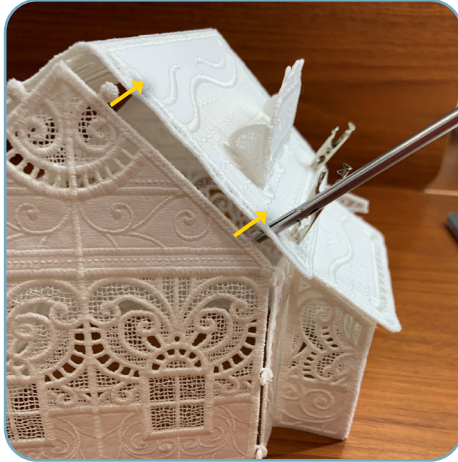

STEP 21

- Attach Back Wall FSA (12423-06) to Roof FSA (12423-08) by pulling the two buttonettes along the top of the back wall into the two eyelets on the edge of the roof.



ASSEMBLY



STEP 22

- Attach Floor FSA (12423-09) to the structure by pulling the four buttonettes on floor into each eyelet by pulling the four buttonettes from the floor to the corresponding wall eyelets.

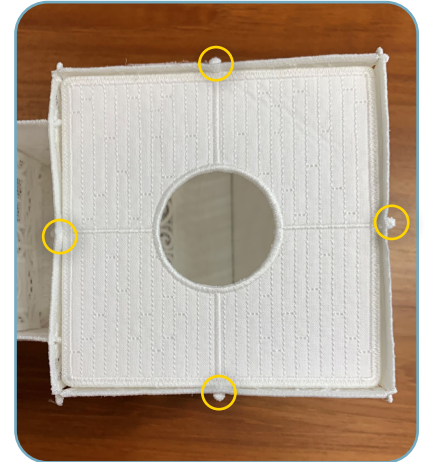

STEP 23

- To assemble the Mailbox FSL (12423-10) attach the 4 buttonettes to the corresponding eyelets as shown.
- Note: You will achieve the best look if you pull the buttonettes into the eyelets so that the buttonettes end up inside the mailbox.

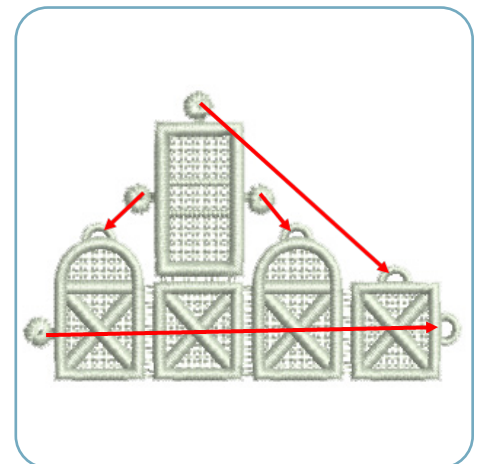

ASSEMBLY



FINISHING TOUCHES

- The post office and mailbox are complete. Enjoy.
- Add tea lights or pixie lights to create a glow.



Stabilizer

- OESD AquaMesh
- OESD BadgeMaster

Notions/Tools

- 80/12 Embroidery Ballpoint Titanium needle for extended needle life
- OESD Alligator Clamps
- OESD Button Clips
- OESD Perfect Point and Press Tool

Isacord Thread Colors

- All OESD designs are digitized with Isacord 40 wt. polyester thread as the top thread and in the bobbin.
- Refer to the thread chart for color specifications.
- Match bobbin thread color to the top thread.

Instructions

Step 1 - Hoop

For FSL structures, hoop one layer of OESD AquaMesh and one layer of OESD BadgeMaster. BadgeMaster contains more starch so, combined with the AquaMesh, the lace is more rigid. For other FSL, where a softer lace is desired, hoop two layers of AquaMesh.

Step 2 - Embroider

Stitch the design per the thread chart with matching thread in the bobbin at each color change. When complete, remove from the hoop and trim away excess stabilizer about 1/4"-1/2" from the stitching.

Step 3 - Rinse

Rinse remaining stabilizer out in warm running water. For stiffer lace and FSL structures, DO NOT rinse away all of the stabilizer. The lace should be just slightly tacky. For softer lace, rinse until all traces of the stabilizer are removed.

Step 4 - Dry

Lay right side down flat on a non-stick surface, such as a cooling rack, parchment paper or Teflon sheet. This minimizes the tendency for the lace to curl. Let the pieces dry completely before proceeding with any assembly.

Step 5 - Press

Once completely dry, press right side down on a OESD Perfect Embroidery Press Cloth.

Step 6 - Assemble Structure

Note: Specific assembly instructions for a design/collection may be found in the thread chart pdf following the individual design color charts.

Lace must be COMPLETELY DRY before assembly. Wetting the buttonettes or eyelets to assemble is not recommended and may result in them stretching and coming "unbuttoned" when dry.

Use a pair of OESD Alligator Clamps to insert the buttonettes into the eyelets. Insert the tip of the OESD Alligator Clamps into the eyelet, grasp the buttonette and pull through the eyelet. Alternatively, use a stiletto or tweezers to push the buttonette through the eyelet.

Helpful Tips

Limp Lace

If the design is not stiff enough, press the lace pieces on the wrong side while applying spray starch. After ironing, spray again with starch and allow to dry completely. This will stiffen the lace pieces nicely and aid in construction. Or easily re-stiffen by diluting some stabilizer scraps in water (or use liquid starch) and dipping the item in the solution. Lay flat to dry.

Eyelets Too Small

If any of the eyelets appear closed or too small to penetrate with Alligator Clamps, they may be stretched by inserting the small end of the OESD Perfect Point and Press Tool into the eyelet opening and stretching it open wide enough to accommodate the OESD Alligator Clamps.

Button Clips

During the assembly process, some structures pull on buttonettes that have already been inserted and could pull them out altogether. Putting a Button Clip on the assembled buttonette will keep it in position during the assembly process. Remove the Button Clips when the assembly is complete.

Alternative Construction Option

In some cases, the buttonettes may be pulled to the inside of a project, instead of being visible on the outside. Insert the OESD Alligator Clamps through the eyelet from the wrong, or inside, of the lace and grasp the corresponding buttonette. Pull the buttonette to the wrong side of the lace. Pulling the buttonettes to the inside may cause stress on the ones already done. Button clips may be placed on the completed buttonette(s) to prevent them from pulling out of the eyelet during construction.

ATTENTION

When printing this document, any page scaling or page fitting options in your print dialog box must be turned OFF or set to NONE so that your files will print out at their actual size. Images not printed at actual size will not function as intended.

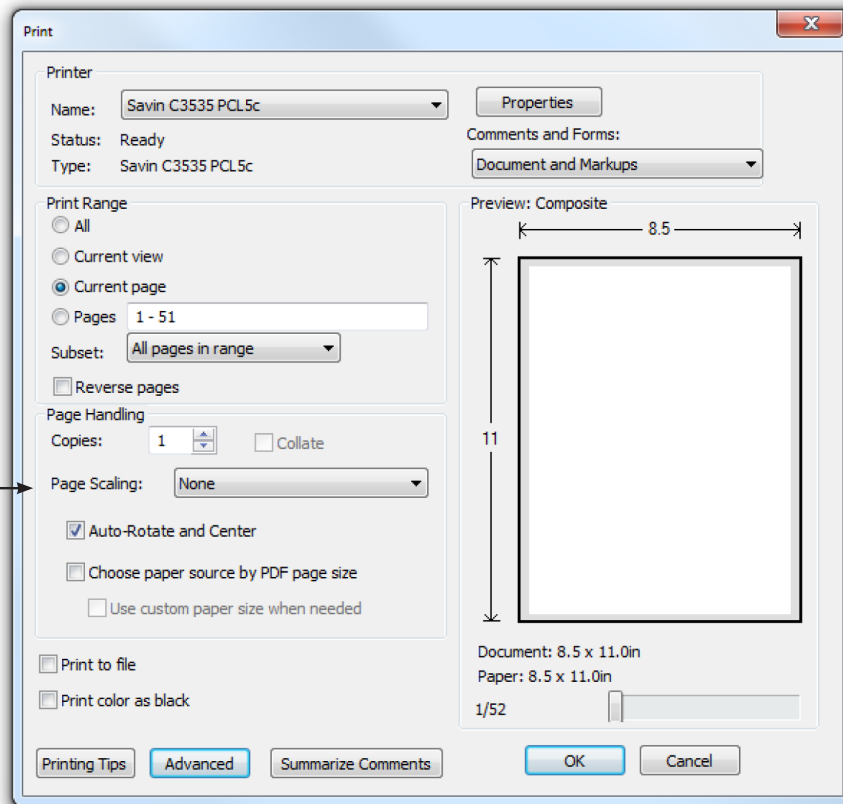

TO SAVE PAPER

Only print the desired image by navigating to the image's page, go to File > Print and select "Current page" in the print dialog box. Repeat for each desired image.

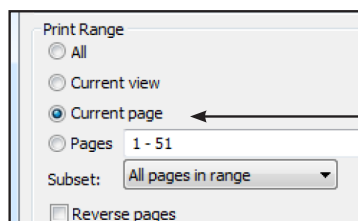

APPLIQUE PATTERNS



Print at 100%. No scaling. This box measures 1" x 1". Use the box as an accuracy guide when printing templates.

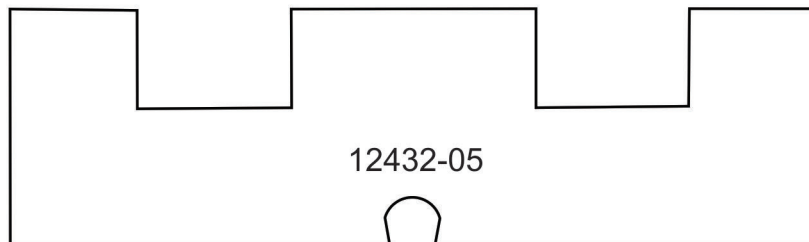
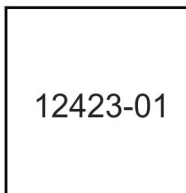
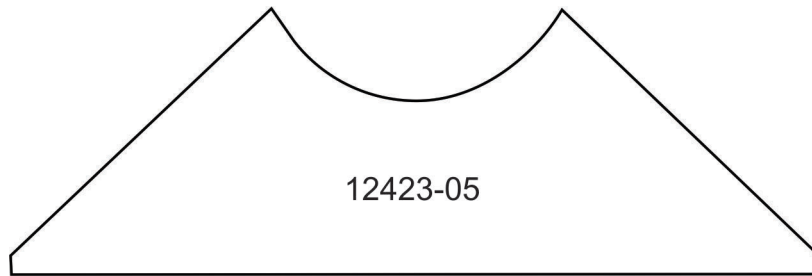
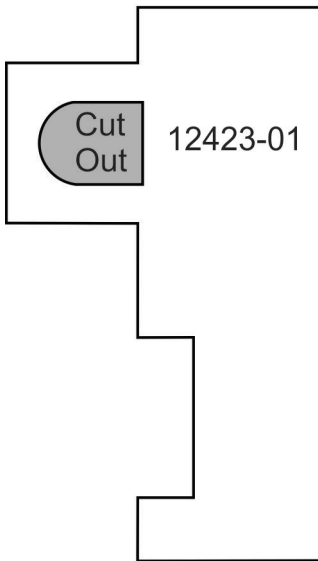
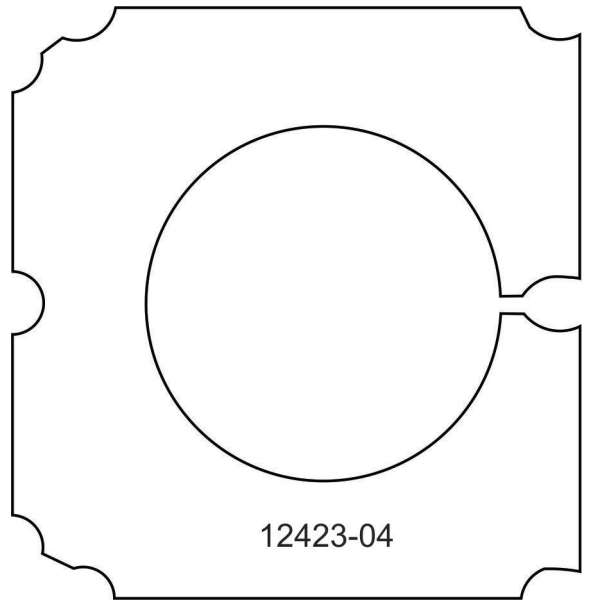
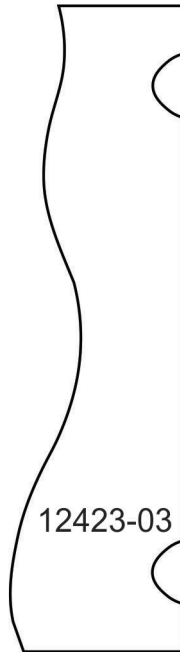
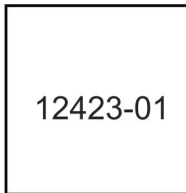

APPLIQUE PATTERNS



Print at 100%. No scaling. This box measures 1" x 1". Use the box as an accuracy guide when printing templates.

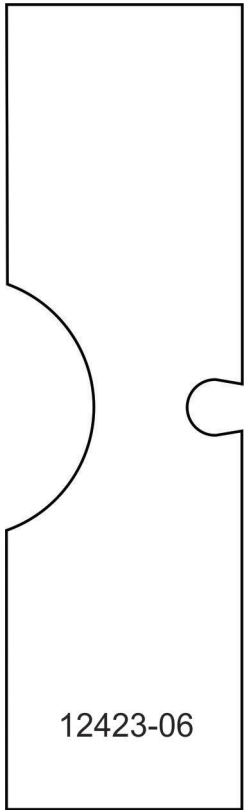

12423-06



12423-07

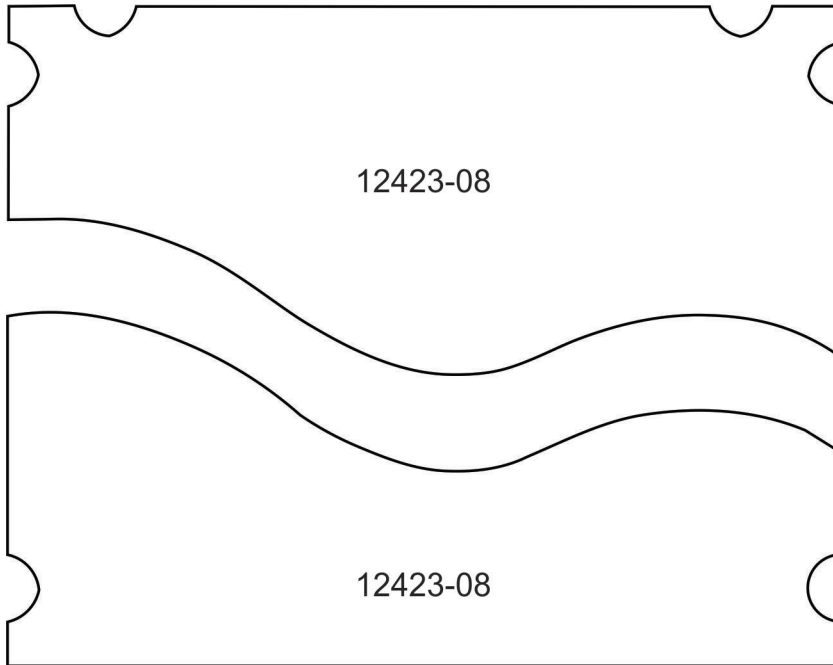

12423-08

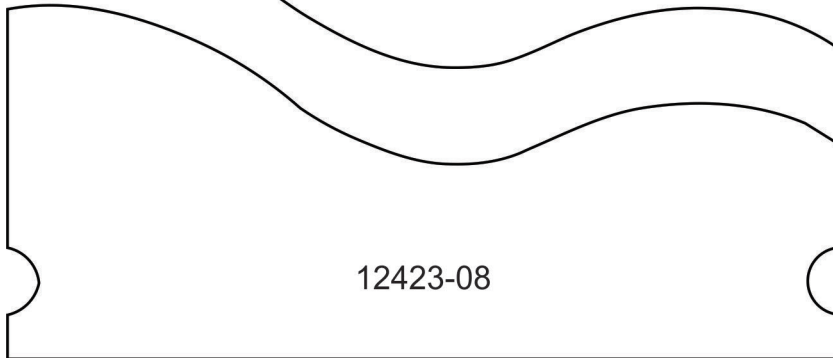

12423-08

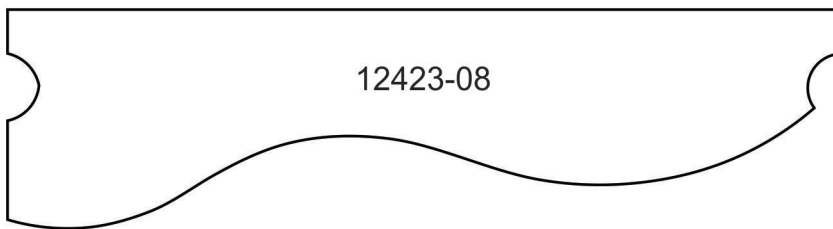

12423-08

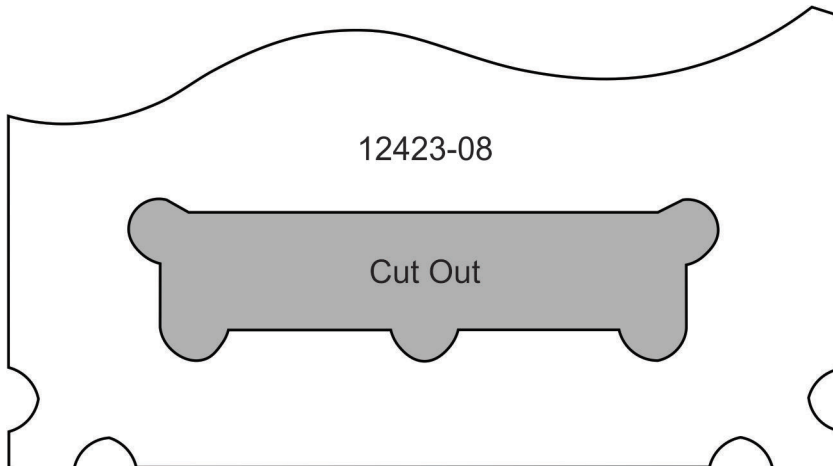

12423-08

Cut Out

APPLIQUE PATTERNS



Print at 100%. No scaling. This box measures 1" x 1". Use the box as an accuracy guide when printing templates.

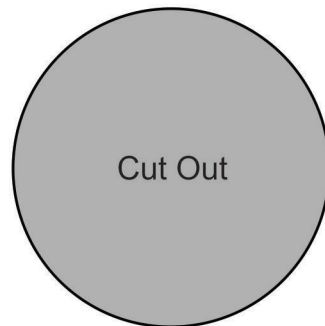

12423-09

MIRRORED PATTERNS



Print at 100%. No scaling. This box measures 1" x 1". Use the box as an accuracy guide when printing templates.

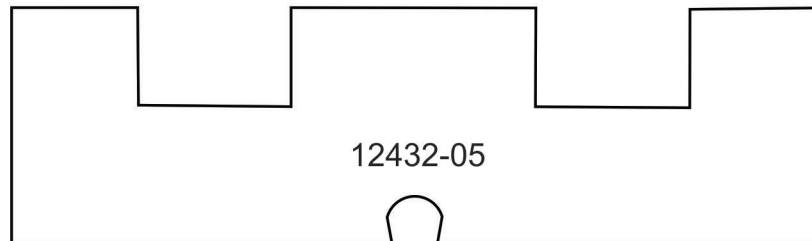
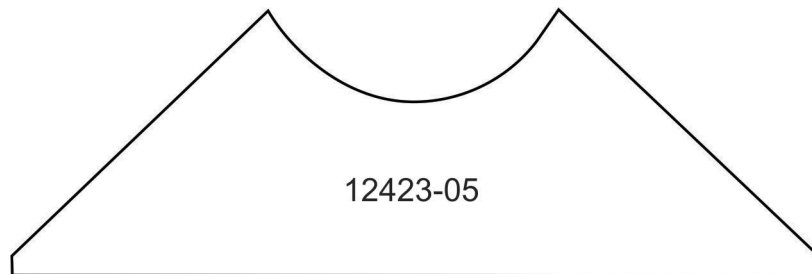
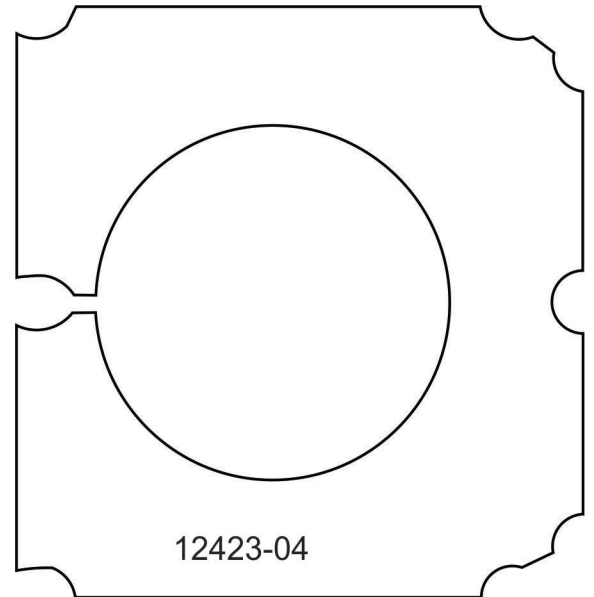
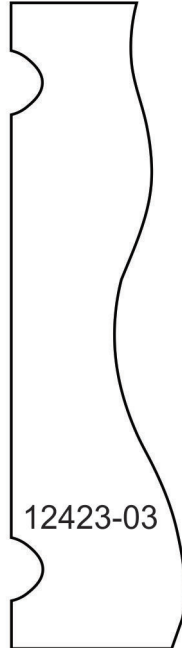
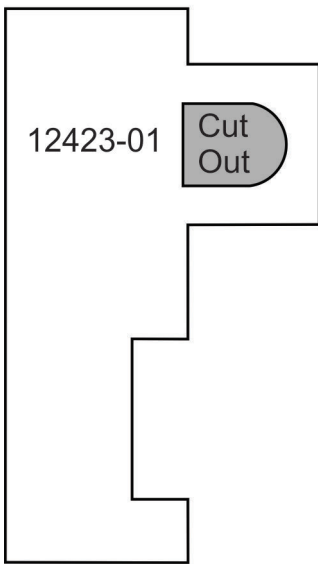

MIRRORED PATTERNS



Print at 100%. No scaling. This box measures 1" x 1". Use the box as an accuracy guide when printing templates.

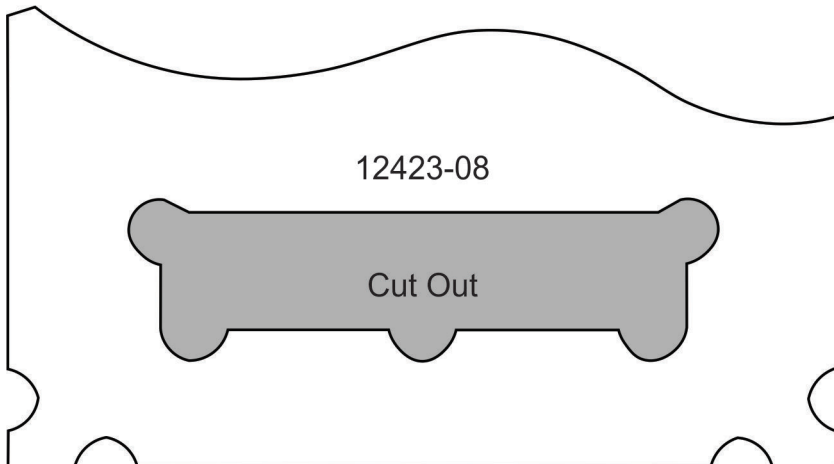
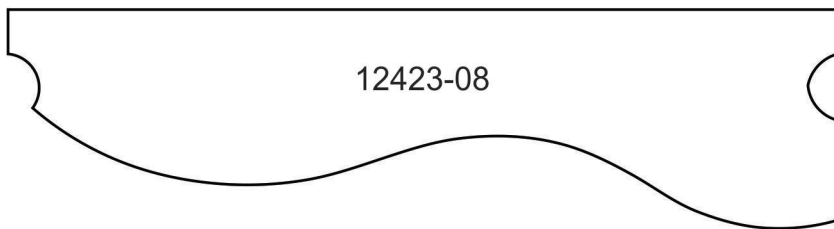
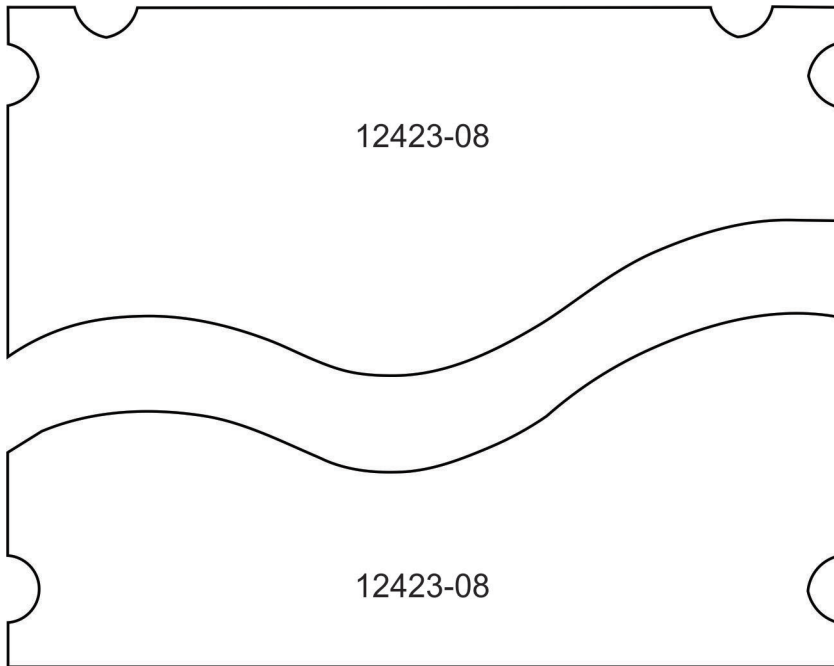
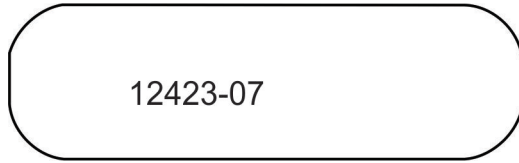
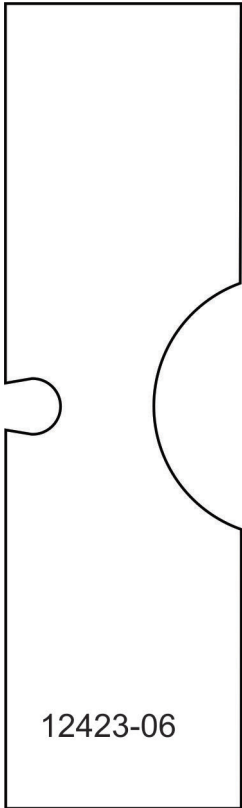

MIRRORED PATTERNS



Print at 100%. No scaling. This box measures 1" x 1". Use the box as an accuracy guide when printing templates.

