



**FREESTANDING
Quilt Shop
and Lamp Post**



1

Design

Fits hoop size 6" x 10"

THREAD LIST



Isacord Thread Colors

0015 White

*** Project instructions included after design list.**

Note: One spool of 1000 meter thread is adequate for the project unless otherwise noted.

DESIGNS

Note: Some designs in this collection may have been created using unique special stitches and/or techniques. To preserve design integrity when rescaling or rotating designs in your software, always rescale or rotate designs using the handles directly on-screen.

*Fabric Required

12466-01 Inner Wall FSA

Size Inches: Size mm: Stitch Count:
4.9 X 6.13 in. 124.46 X 155.7 mm 31,492 St.

- 1. Walls and Door Placement Stitch 0015
- 2. Walls and Door Cut Line and Tackdown..... 0015
- 3. Diamond Placement Stitch 0015
- 4. Diamond Cut Line and Tackdown..... 0015
- 5. Lace..... 0015

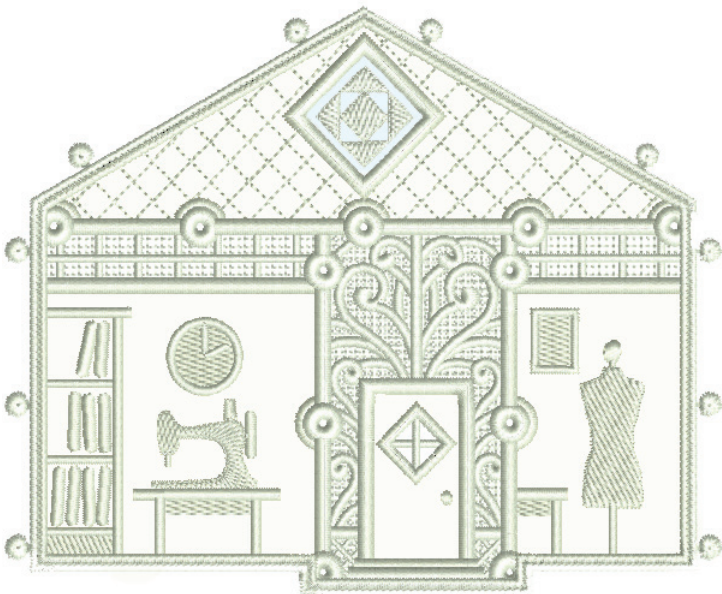

Note: Some designs in this collection may have been created using unique special stitches and/or techniques. To preserve design integrity when rescaling or rotating designs in your software, always rescale or rotate designs using the handles directly on-screen.

***Fabric Required**

12466-02 Windows Front FSA

Size Inches: Size mm: Stitch Count:
 3.99 X 6.12 in. 101.35 X 155.45 mm 29,615 St.

- 1. Placement Stitch 0015
- 2. Cut Line and Tackdown 0015
- 3. Lace..... 0015

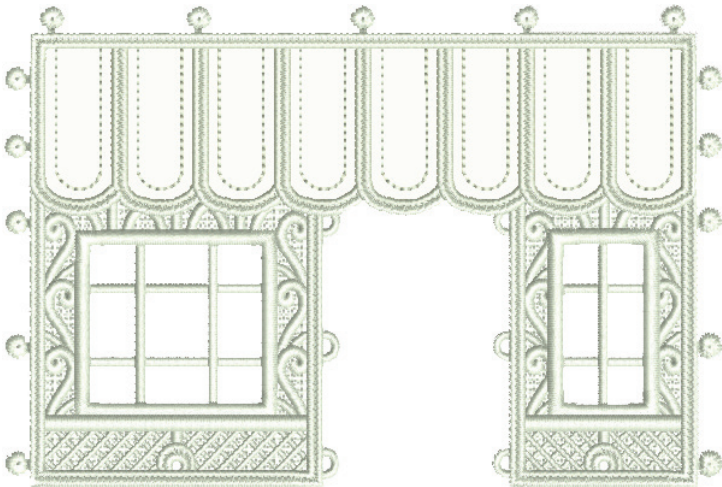

***Fabric Required**

12466-03 Back Wall FSA

Size Inches: Size mm: Stitch Count:
 4.88 X 6.1 in. 123.95 X 154.94 mm 50,352 St.

- 1. Placement Stitches..... 0015
- 2. Cut Lines and Tackdowns 0015
- 3. Lace..... 0015

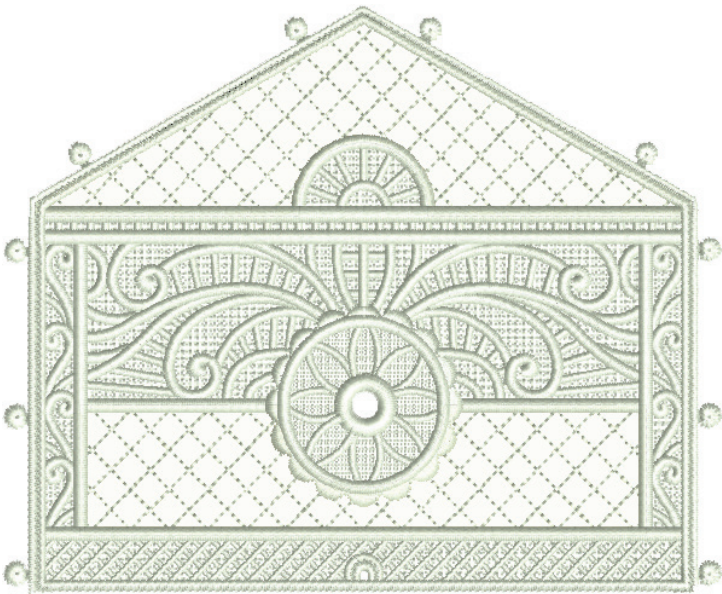

Note: Some designs in this collection may have been created using unique special stitches and/or techniques. To preserve design integrity when rescaling or rotating designs in your software, always rescale or rotate designs using the handles directly on-screen.

***Fabric Required**

12466-04 Left Side Wall FSA

Size Inches: Size mm: Stitch Count:
 3.5 X 4.5 in. 88.9 X 114.3 mm 31,991 St.

- 1. Placement Stitch 0015
- 2. Cut Line and Tackdown 0015
- 3. Lace..... 0015

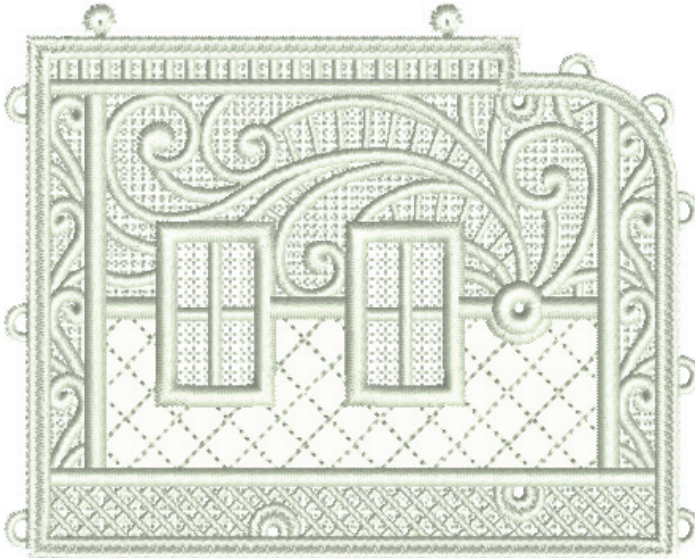

***Fabric Required**

12466-05 Right Side Wall FSA

Size Inches: Size mm: Stitch Count:
 3.5 X 4.5 in. 88.9 X 114.3 mm 32,061 St.

- 1. Placement Stitch 0015
- 2. Cut Line and Tackdown 0015
- 3. Lace..... 0015

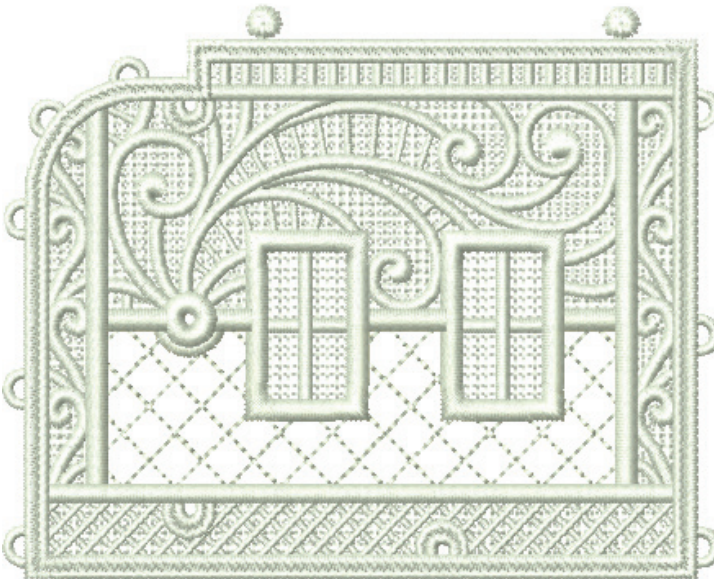

Note: Some designs in this collection may have been created using unique special stitches and/or techniques. To preserve design integrity when rescaling or rotating designs in your software, always rescale or rotate designs using the handles directly on-screen.

***Fabric Required**

12466-06 Foundation FSA

Size Inches: Size mm: Stitch Count:
 4.65 X 6.12 in. 118.11 X 155.45 mm 14,173 St.

- 1. Placement Stitches..... 0015
- 2. Cut Lines and Tackdowns 0015
- 3. Lace..... 0015

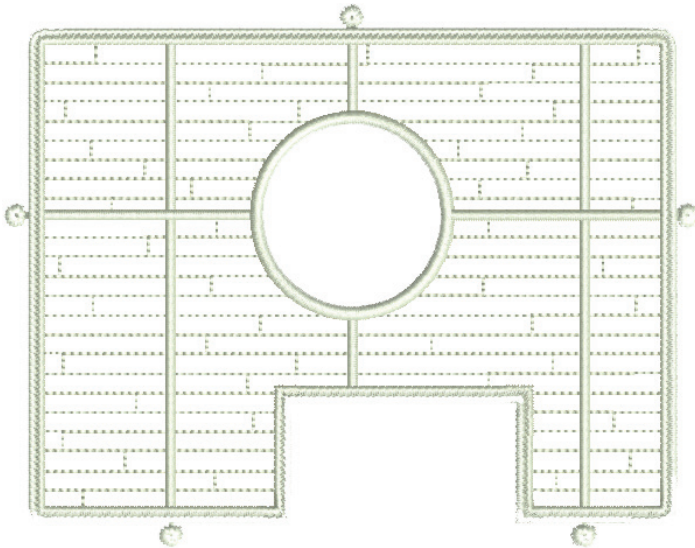

***Fabric Required**

12466-07 Left Roof FSA

Size Inches: Size mm: Stitch Count:
 4.12 X 3.91 in. 104.65 X 99.31 mm 22,635 St.

- 1. Roof Placement Stitch..... 0015
- 2. Roof Cut Line and Tackdown 0015
- 3. Snow Placement Stitch 0015
- 4. Snow Cut Line and Tackdown 0015
- 5. Lace..... 0015

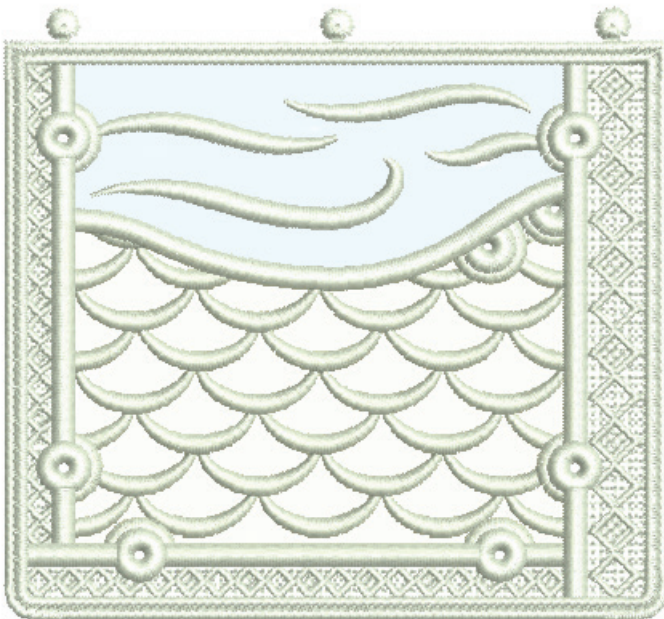

Note: Some designs in this collection may have been created using unique special stitches and/or techniques. To preserve design integrity when rescaling or rotating designs in your software, always rescale or rotate designs using the handles directly on-screen.

***Fabric Required**

12466-08 Right Roof FSA

Size Inches: Size mm: Stitch Count:
 4.12 X 3.84 in. 104.65 X 97.54 mm 22,593 St.

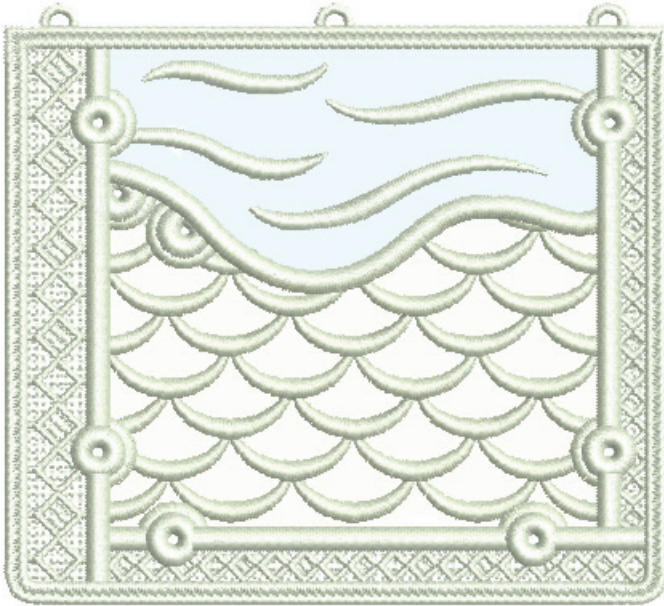

- 1. Roof Placement Stitch..... 0015
- 2. Roof Cut Line and Tackdown 0015
- 3. Snow Placement Stitch 0015
- 4. Snow Cut Line and Tackdown 0015
- 5. Lace..... 0015

12466-09 Entryway Left Side Wall FSL

Size Inches: Size mm: Stitch Count:
 1.45 X 3.07 in. 36.83 X 77.98 mm 9,033 St.

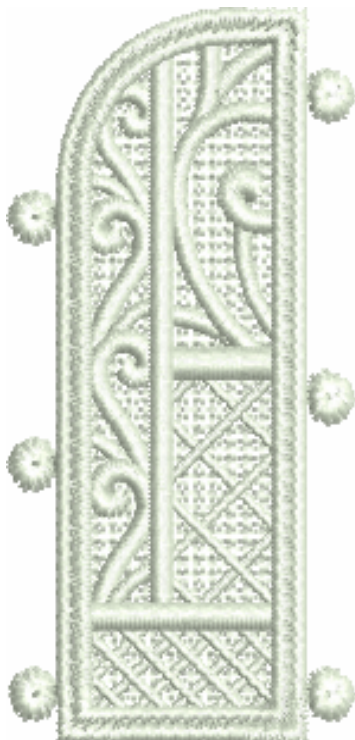

- 1. Lace..... 0015

Note: Some designs in this collection may have been created using unique special stitches and/or techniques. To preserve design integrity when rescaling or rotating designs in your software, always rescale or rotate designs using the handles directly on-screen.



12466-10 Entryway Right Side Wall FSL

Size Inches: Size mm: Stitch Count:
 1.45 X 3.07 in. 36.83 X 77.98 mm 9,169 St.

1. Lace..... 0015

*Fabric Required

12466-11 Sign FSA

Size Inches: Size mm: Stitch Count:
 3.45 X 1.83 in. 87.63 X 46.48 mm 6,082 St.

1. Placement Stitch 0015
 2. Cut Line and Tackdown 0015
 3. Lace..... 0015
 4. Lettering 0015



Note: Some designs in this collection may have been created using unique special stitches and/or techniques. To preserve design integrity when rescaling or rotating designs in your software, always rescale or rotate designs using the handles directly on-screen.

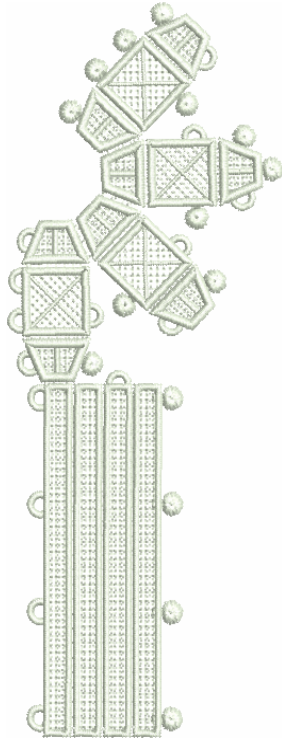

12466-12 Lamp Post FSL

Size Inches: Size mm: Stitch Count:
 2.58 X 6.87 in. 65.53 X 174.5 mm 17,935 St.

1. Lace..... 0015

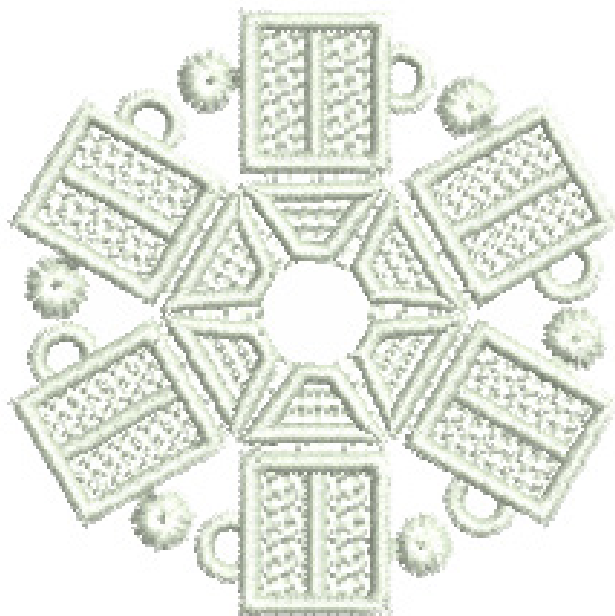

12466-13 Lamp Post Base FSL

Size Inches: Size mm: Stitch Count:
 2.11 X 2.14 in. 53.59 X 54.36 mm 7,783 St.

1. Lace..... 0015

Stabilizers

- OESD AquaMesh
- OESD BadgeMaster
- OESD StabilStick CutAway

Fabrics/Textiles

- White cotton fabric 1/4 yard
- Note: Fabric sizes are estimates and may result in overage.

Notions & Tools

- OESD Alligator Clamps
- OESD Button Clips
- OESD Expert Embroidery Tape WashAway
- OESD Expert Point and Press Tool
- OESD Perfect Embroidery Press Cloth
- Embroidery Needle Sharp 75/11

Isacord Thread Colors

- Per thread chart
- Match bobbin thread to top thread
- 0015 White (1 spool)

SUMMARY



Completed Size: 6" x 4" x 6"

12466-01



Requires 1 Design

12466-02

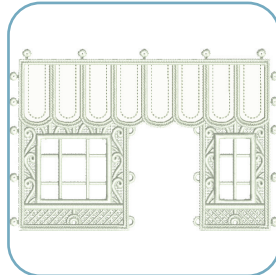

Requires 1 Design

12466-03

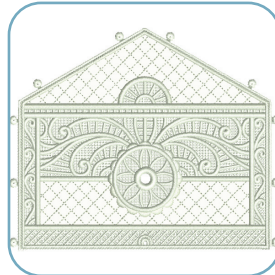

Requires 1 Design

12466-04

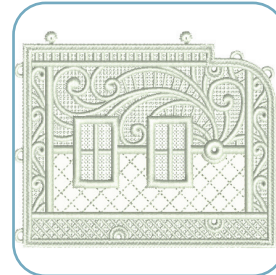

Requires 1 Design

12466-05



Requires 1 Design

12466-06

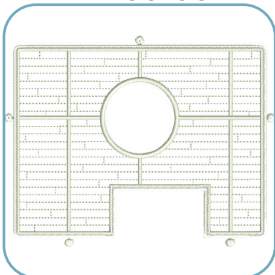

Requires 1 Design

12466-07

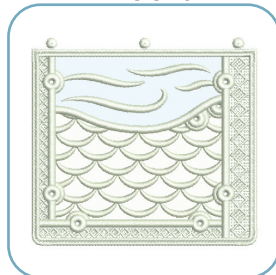

Requires 1 Design

12466-08

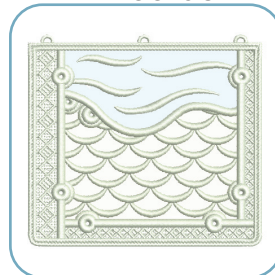

Requires 1 Design

12466-09

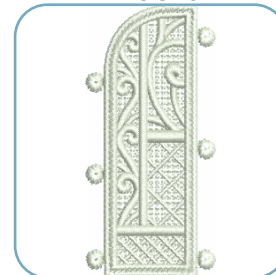

Requires 1 Design

12466-10



Requires 1 Design

12466-11



Requires 1 Design

12466-12

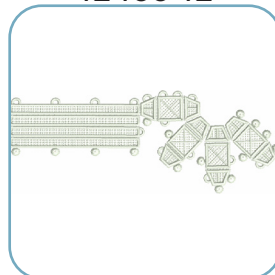

Requires 1 Design

12466-13

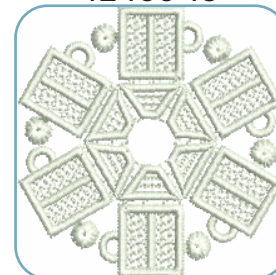

Requires 1 Design

Notes

The project includes freestanding applique designs and freestanding lace designs. All applique designs are stitched the same as shown in the instructions.

All designs are stitched with matching thread in the top and bobbin.

For other designs in the collection, use the applique templates as a guide to the dimensions of the various applique pieces.

Note: Some thread colors in instructions have been changed or digitally enhanced for better visibility.

STEP 1

- Hoop one layer of AquaMesh and one layer of BadgeMaster for all designs.



STEP 2

- Adhere two layers of StabilStick CutAway to the wrong side of all applique fabrics, to provide stiffness to the finished structure.
- Cut the prepared applique fabrics 1/4"-1/2" larger than the templates.



EMBROIDERY



STEP 3

- Load selected design into the machine.
- Example design is 12466-01.
- Place hoop on the machine.
- Thread the machine per the thread chart.
- Stitch Machine Step 1, Wall & Door Placement Stitch.

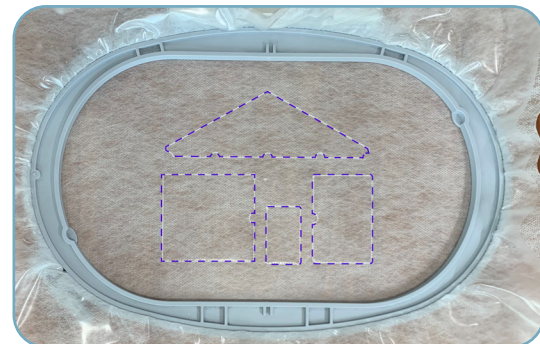

STEP 4

- Remove the hoop from the machine, but NOT the project from the hoop.
- Lay the hoop on a flat surface.
- Place a piece of prepared fabric slightly larger than the placement line.
- Tape in place to secure.

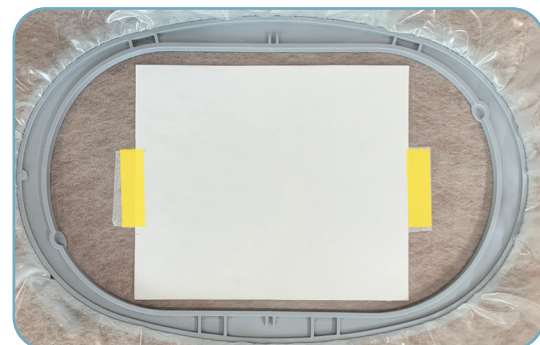

STEP 5

- Return the hoop to the machine.
- Stitch Machine Step 2, Walls & Door Cut Line and Tackdown.

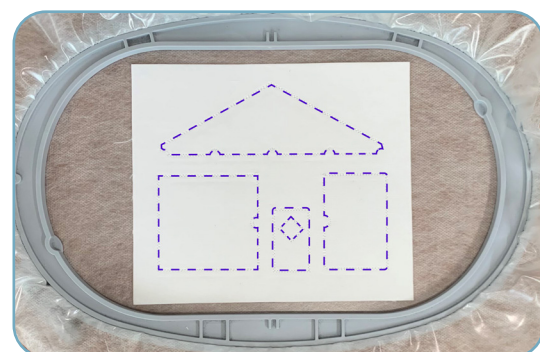

EMBROIDERY



STEP 6

- Remove the hoop from the machine, but NOT the project from the hoop.
- Trim the excess fabric as close to the cut line as possible. If the outermost stitches are cut, the inner stitches will still hold the applique in place.
- Tip: If the AquaMesh is cut or a hole is created while trimming the fabric, use Expert Embroidery Tape WashAway or AquaMesh Plus as a patch.



STEP 7

- Return the hoop to the machine.
- Stitch Machine Step 3, Diamond Placement Stitch.
- Note: Do not trim inside the Diamond Placement Stitch.

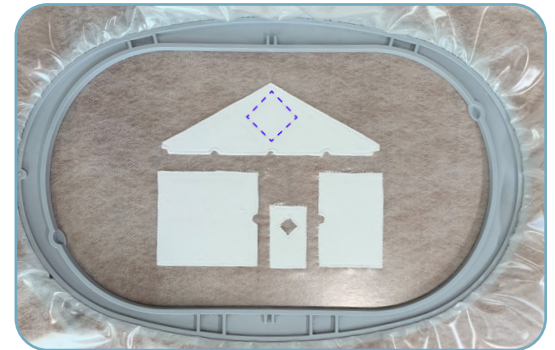

STEP 8

- Remove the hoop from the machine, but NOT the project from the hoop.
- Completely cover the placement stitch with the prepared fabric.
- Tape in place with Embroidery Tape WashAway to secure.
- Note: For added sparkle choose a coordinated color fabric for the diamond detailing.



EMBROIDERY



STEP 9

- Return the hoop to the machine.
- Stitch Machine Step 4, Diamond Cut Line & Tackdown.
- Trim the excess fabric as close to the cut line stitching as possible.



STEP 10

- Return the hoop to the machine.
- Stitch Machine Step 5, Lace.
- Remember to match the bobbin thread to the upper thread colors.
- When design is complete, remove the project from the hoop and trim the stabilizer 1/4" - 1/2" outside the design.
- Note: Designs 12466-09, 12466-10, 12466-12 and 12466-13 are lace, not applique.



ASSEMBLY



STEP 11

- Rinse each piece in warm running water until the design is only slightly tacky.
- Lay face down on a non-stick surface to dry.
- Tip: Parchment paper or a cooling rack work well. This prevents the piece from curling.
- Press each piece, right side down, on a Perfect Embroidery Press Cloth.



STEP 12

- Using alligator clamps attach Back Wall FSA (12466-03) to the Left Side Wall FSA (12466-04) and to the Right Side Wall FSA (12466-05) by pulling the three buttonettes into the corresponding eyelets.



STEP 13

- Attach the Inner Wall Applique FSA (12466-01) to Entryway Left Side Wall FSL (12466-09) and to Entryway Right Side Wall FSL (12466-10) by pulling the three buttonettes on the entryway walls into the three eyelets on either side of the shop door on the inner wall.

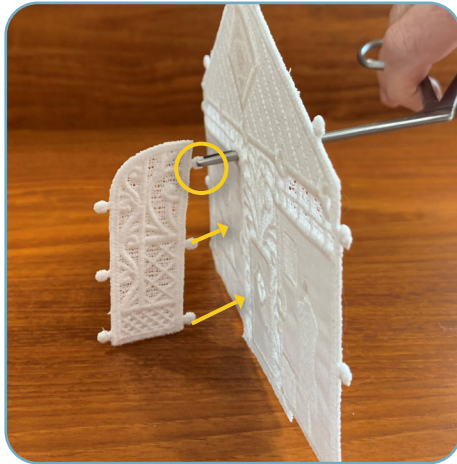

STEP 14

- Attach Windows Front FSA (12466-02) to Inner Wall FSA (12466-01) by pulling the five buttonettes on the windows front into the corresponding inner wall eyelets.

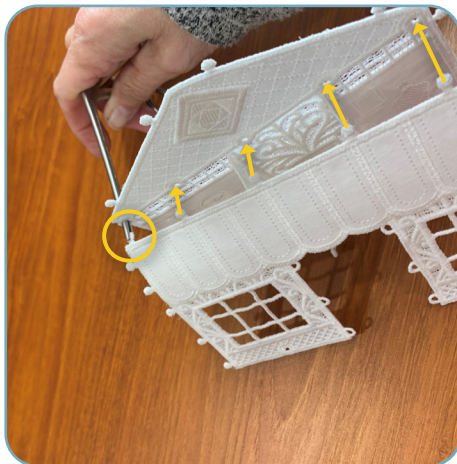

STEP 15

- Attach Windows Front FSA (12466-02) to Entryway Left Side Wall FSL (12466-09) and to Entryway Right Side Wall FSL (12466-10) by pulling the three buttonettes into the corresponding eyelets.

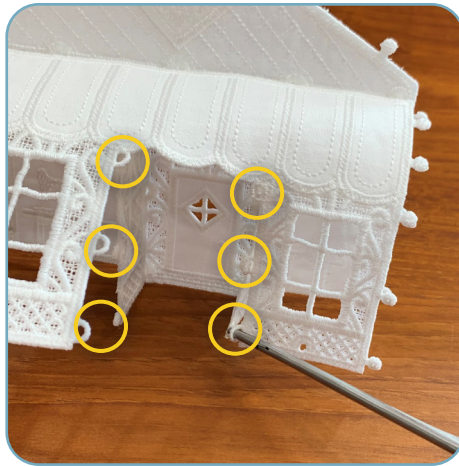

STEP 16

- Attach the front wall unit to the rest of the structure by pulling the three buttonettes of Inner Wall FSA (12466-01) into the three eyelets of Left Side Wall FSA (12466-04).

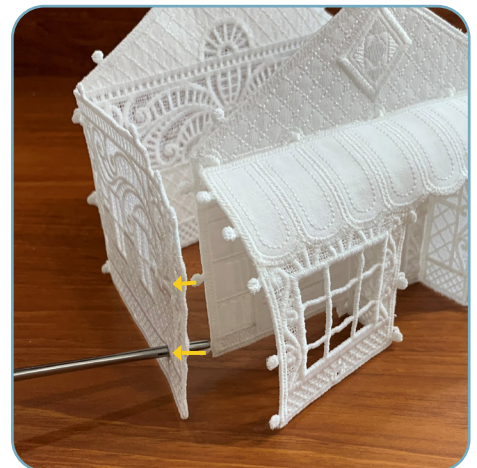

ASSEMBLY



STEP 17

- Repeat this process with the right side.

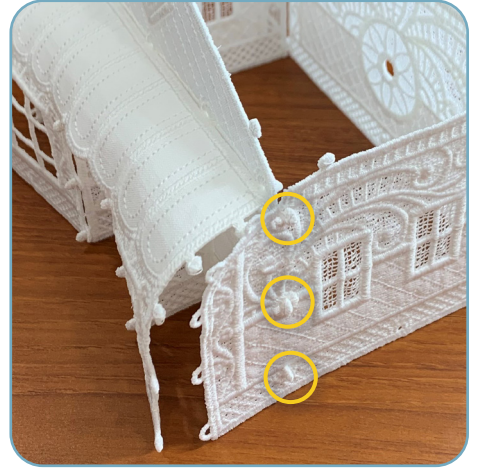

STEP 18

- Attach Windows Front FSA (12466-02) to Left Side Wall FSA (12466-04) and to Right Side Wall FSA (12466-05) by pulling the five buttonettes remaining on each side of the windows front into the corresponding eyelets.

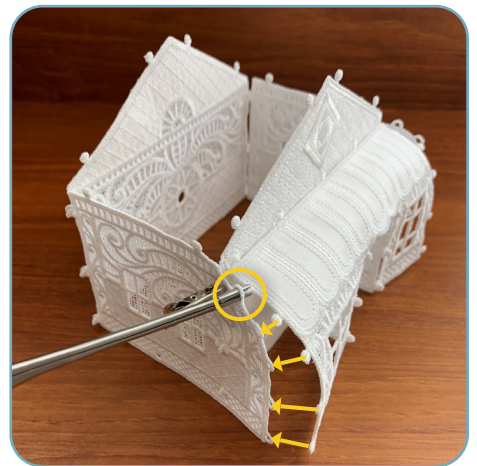

ASSEMBLY



STEP 19

- Attach the Left Roof FSA (12466-07) to Right Roof FSA (12466-08) by pulling the three buttonettes on the left roof into the three eyelets on the right roof.



STEP 20

- Attach Sign FSA (12466-11) to the left and right roof panels by pulling the four buttonettes of the sign into the coordinating roof panel eyelets.
- When sign is attached, it will force the roof into an angle.

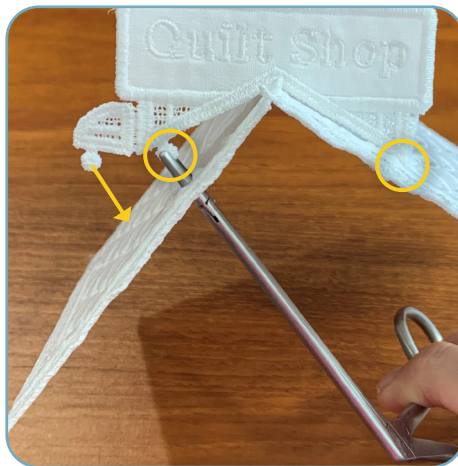

STEP 21

- Attach the roof unit to the structure by pulling the upper buttonettes of the front and back walls into the eyelets of the roof panels. Continue down the slope of the roof, alternating sides for stability.
- Finish by pulling the buttonettes of the left and right walls into the eyelets of the roof panels.



STEP 22

- Attach Foundation FSA (12466-06) to the structure by pulling the buttonettes into the corresponding eyelets.

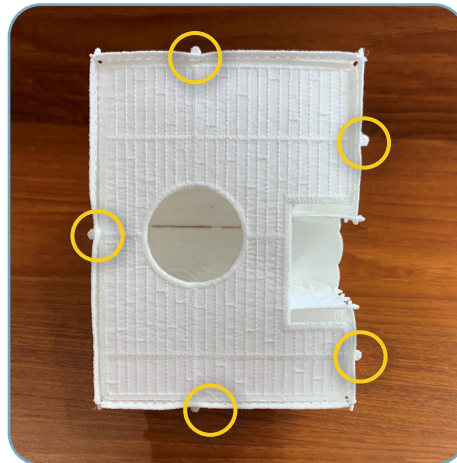
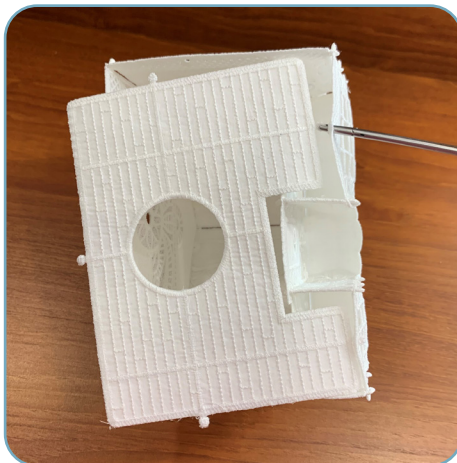

STEP 23 - LAMP POST

- Tip: It is helpful to shape the Lamp Post FSL (12466-12) around a pencil.

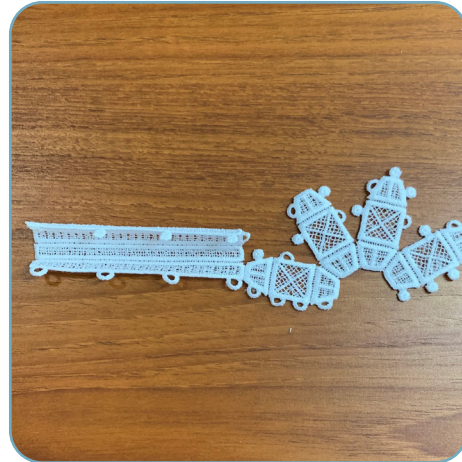

STEP 24

- Attach the post along the side by pulling the four buttonettes into the four eyelets.
- Attach the 10 buttonettes on the lamp fixture to their corresponding eyelets as shown.

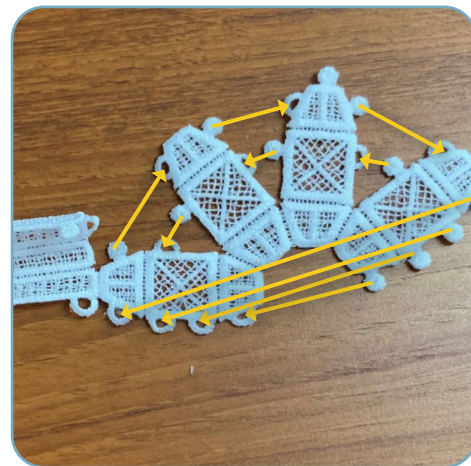

ASSEMBLY



STEP 25

- Secure the lamp fixture to the lamp post by pulling the buttonette along the bottom of the lamp fixture into the eyelet at the top of the post.



STEP 26

- Assemble the Lamp Post Base (12466-13) by pulling the buttonettes of each panel into the eyelet of the very next panel.



STEP 27

- Insert the lamp post into the lamp post base with alligator clamps.
- Use the Expert Point and Press Tool to shape the lamp fixture if needed.

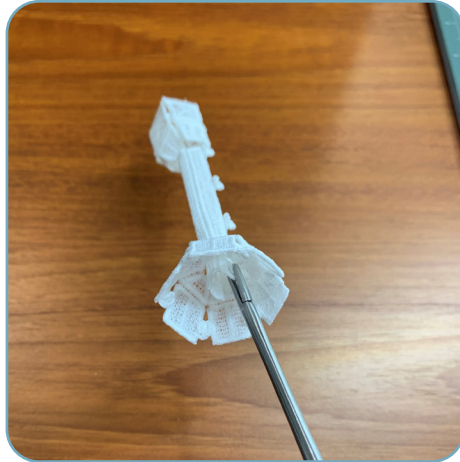

FINISHING TOUCHES

- The quilt shop and lamp post are complete. Enjoy.
- Add tea lights or pixie lights to create a glow.



Stabilizer

- OESD AquaMesh
- OESD BadgeMaster

Notions/Tools

- 80/12 Embroidery Ballpoint Titanium needle for extended needle life
- OESD Alligator Clamps
- OESD Button Clips
- OESD Perfect Point and Press Tool

Isacord Thread Colors

- All OESD designs are digitized with Isacord 40 wt. polyester thread as the top thread and in the bobbin.
- Refer to the thread chart for color specifications.
- Match bobbin thread color to the top thread.

Instructions

Step 1 - Hoop

For FSL structures, hoop one layer of OESD AquaMesh and one layer of OESD BadgeMaster. BadgeMaster contains more starch so, combined with the AquaMesh, the lace is more rigid. For other FSL, where a softer lace is desired, hoop two layers of AquaMesh.

Step 2 - Embroider

Stitch the design per the thread chart with matching thread in the bobbin at each color change. When complete, remove from the hoop and trim away excess stabilizer about 1/4"-1/2" from the stitching.

Step 3 - Rinse

Rinse remaining stabilizer out in warm running water. For stiffer lace and FSL structures, DO NOT rinse away all of the stabilizer. The lace should be just slightly tacky. For softer lace, rinse until all traces of the stabilizer are removed.

Step 4 - Dry

Lay right side down flat on a non-stick surface, such as a cooling rack, parchment paper or Teflon sheet. This minimizes the tendency for the lace to curl. Let the pieces dry completely before proceeding with any assembly.

Step 5 - Press

Once completely dry, press right side down on a OESD Perfect Embroidery Press Cloth.

Step 6 - Assemble Structure

Note: Specific assembly instructions for a design/collection may be found in the thread chart pdf following the individual design color charts.

Lace must be COMPLETELY DRY before assembly. Wetting the buttonettes or eyelets to assemble is not recommended and may result in them stretching and coming "unbuttoned" when dry.

Use a pair of OESD Alligator Clamps to insert the buttonettes into the eyelets. Insert the tip of the OESD Alligator Clamps into the eyelet, grasp the buttonette and pull through the eyelet. Alternatively, use a stiletto or tweezers to push the buttonette through the eyelet.

Helpful Tips

Limp Lace

If the design is not stiff enough, press the lace pieces on the wrong side while applying spray starch. After ironing, spray again with starch and allow to dry completely. This will stiffen the lace pieces nicely and aid in construction. Or easily re-stiffen by diluting some stabilizer scraps in water (or use liquid starch) and dipping the item in the solution. Lay flat to dry.

Eyelets Too Small

If any of the eyelets appear closed or too small to penetrate with Alligator Clamps, they may be stretched by inserting the small end of the OESD Perfect Point and Press Tool into the eyelet opening and stretching it open wide enough to accommodate the OESD Alligator Clamps.

Button Clips

During the assembly process, some structures pull on buttonettes that have already been inserted and could pull them out altogether. Putting a Button Clip on the assembled buttonette will keep it in position during the assembly process. Remove the Button Clips when the assembly is complete.

Alternative Construction Option

In some cases, the buttonettes may be pulled to the inside of a project, instead of being visible on the outside. Insert the OESD Alligator Clamps through the eyelet from the wrong, or inside, of the lace and grasp the corresponding buttonette. Pull the buttonette to the wrong side of the lace.

Pulling the buttonettes to the inside may cause stress on the ones already done. Button clips may be placed on the completed buttonette(s) to prevent them from pulling out of the eyelet during construction.

ATTENTION

When printing this document, any page scaling or page fitting options in your print dialog box must be turned OFF or set to NONE so that your files will print out at their actual size. Images not printed at actual size will not function as intended.

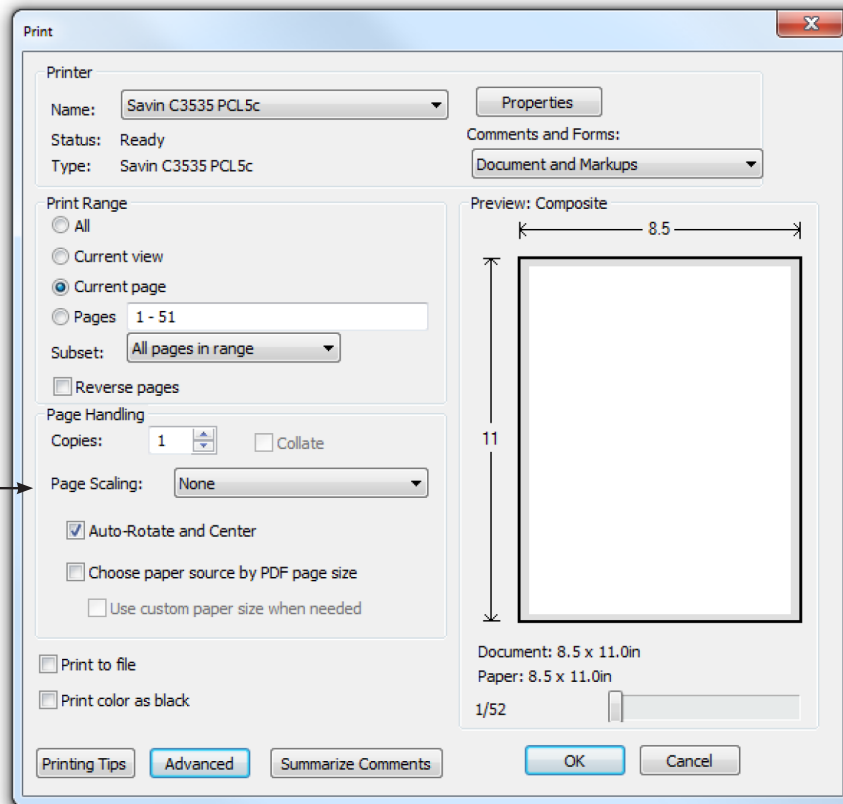

TO SAVE PAPER

Only print the desired image by navigating to the image's page, go to File > Print and select "Current page" in the print dialog box. Repeat for each desired image.

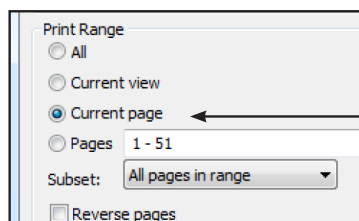

APPLIQUE PATTERNS



Print at 100%. No scaling. This box measures 1" x 1". Use the box as an accuracy guide when printing templates.

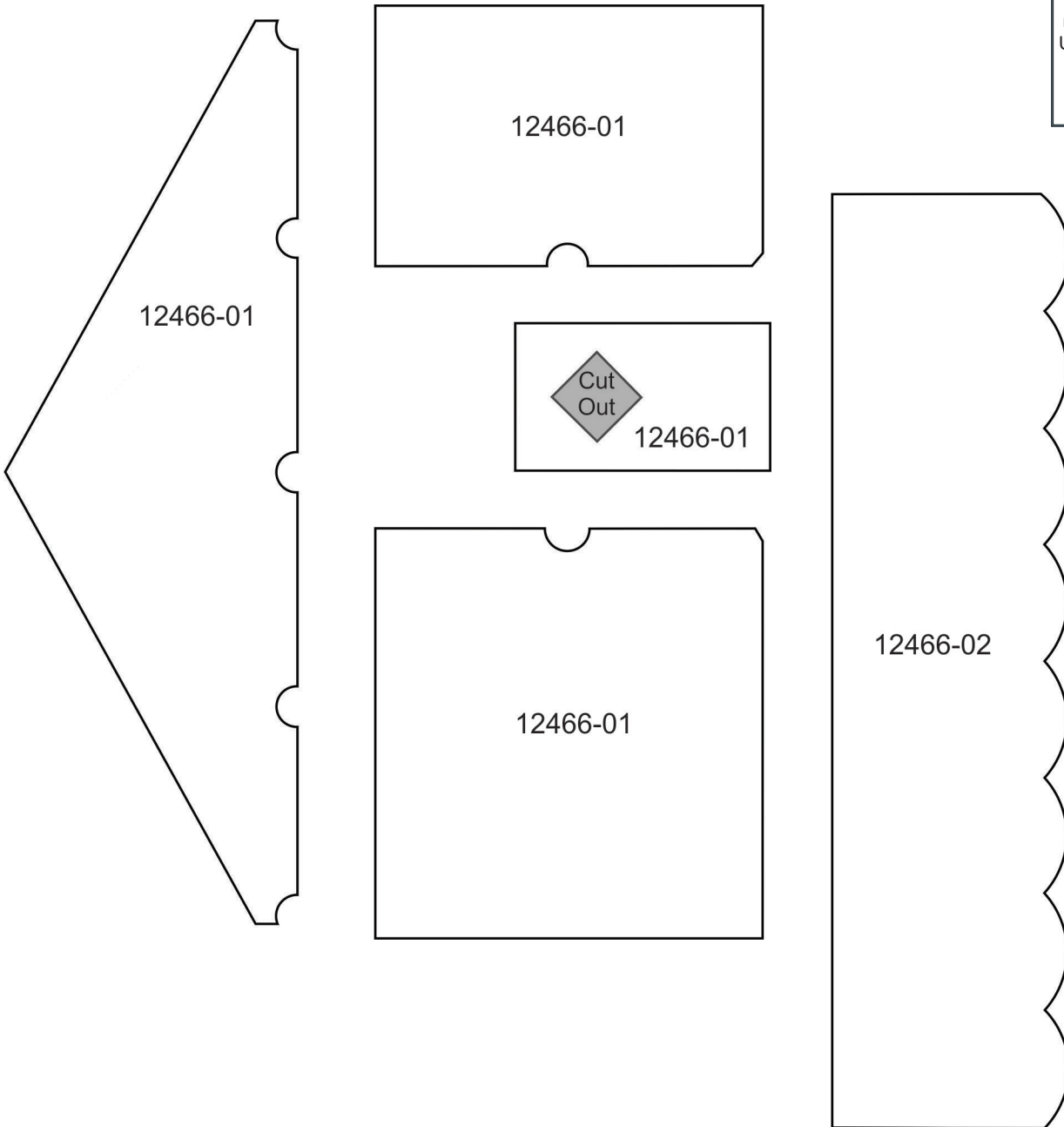

APPLIQUE PATTERNS



Print at 100%. No scaling. This box measures 1" x 1". Use the box as an accuracy guide when printing templates.

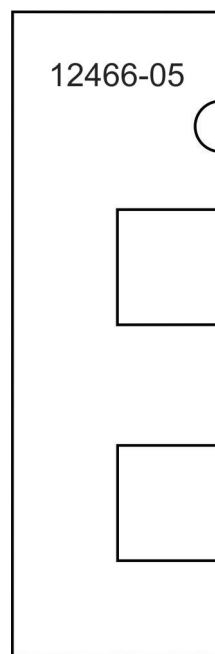
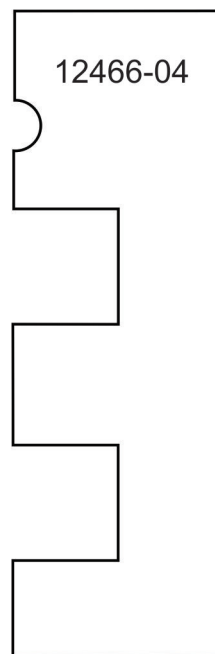
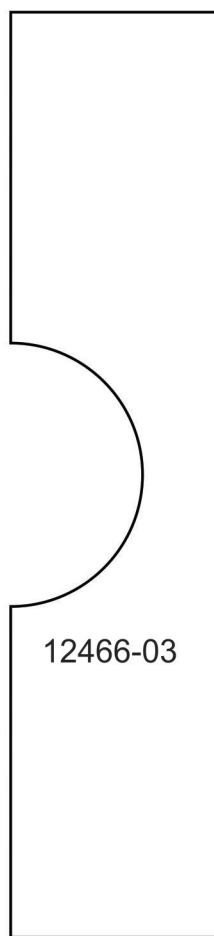
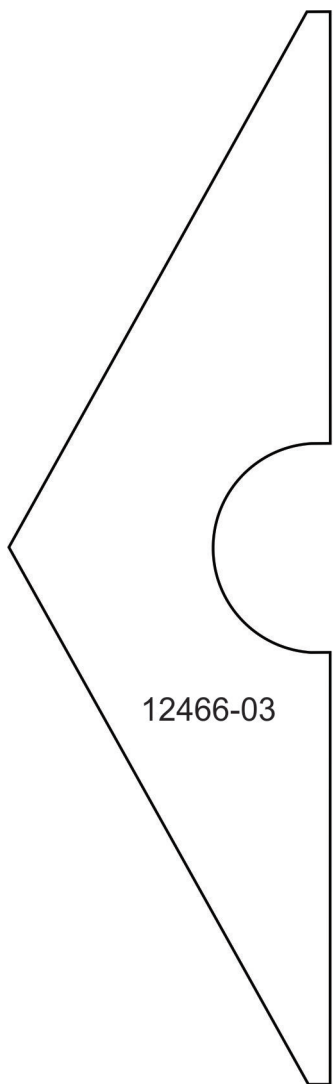

APPLIQUE PATTERNS



Print at 100%. No scaling. This box measures 1" x 1". Use the box as an accuracy guide when printing templates.

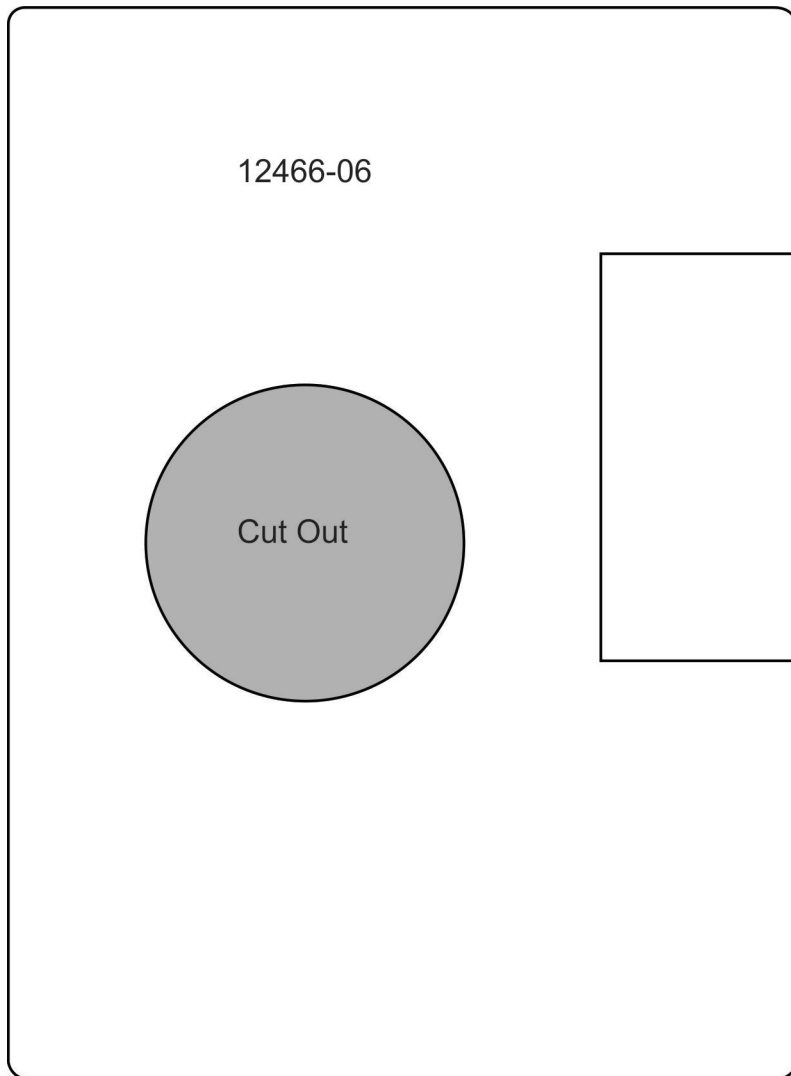

APPLIQUE PATTERNS



Print at 100%. No scaling. This box measures 1" x 1". Use the box as an accuracy guide when printing templates.

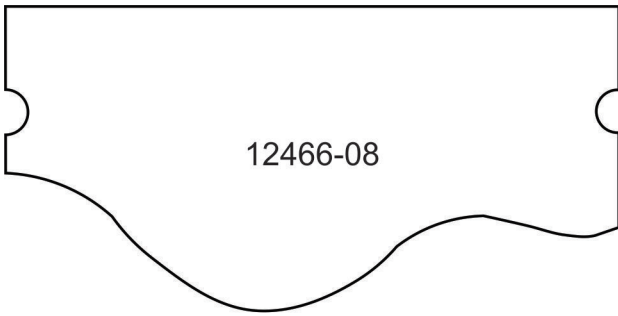

12466-08

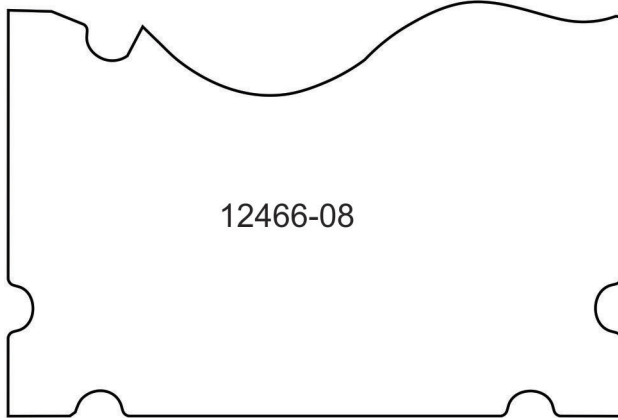

12466-08

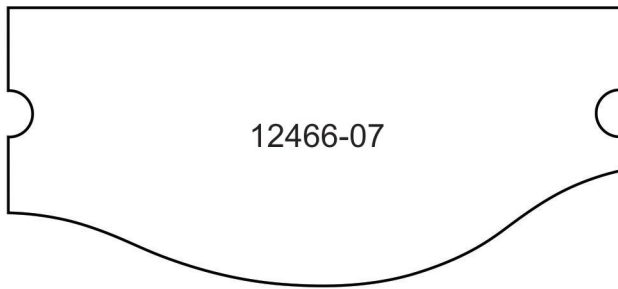

12466-07

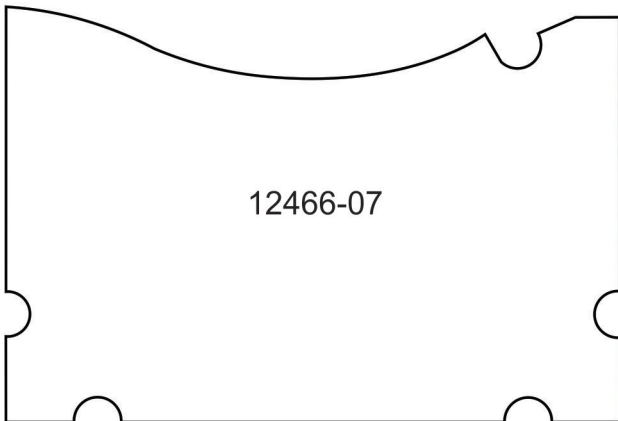

12466-07



12466-11

MIRRORED PATTERNS



Print at 100%. No scaling. This box measures 1" x 1". Use the box as an accuracy guide when printing templates.

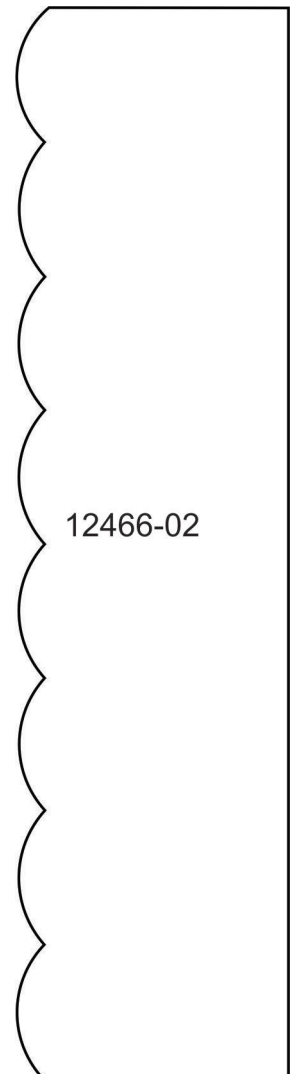
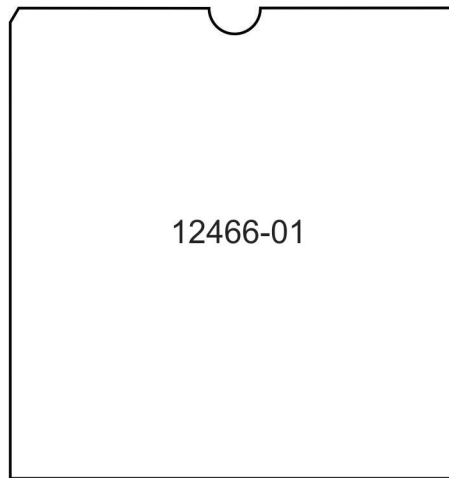
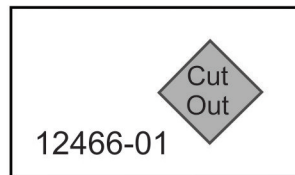
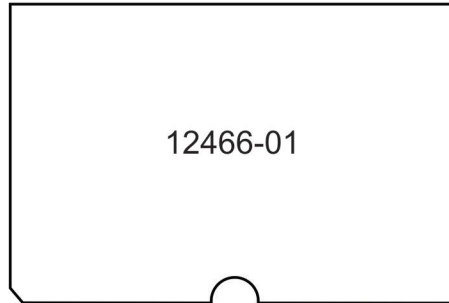
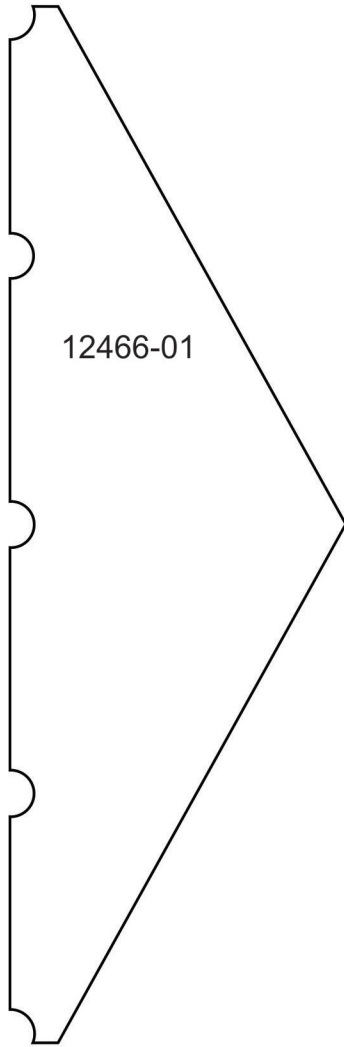

MIRRORED PATTERNS



Print at 100%. No scaling. This box measures 1" x 1". Use the box as an accuracy guide when printing templates.

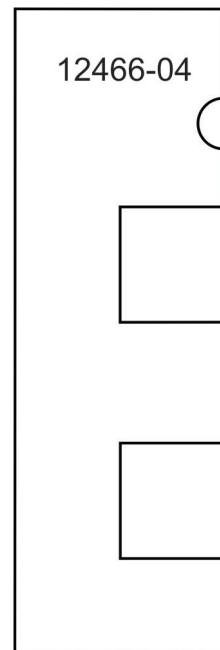
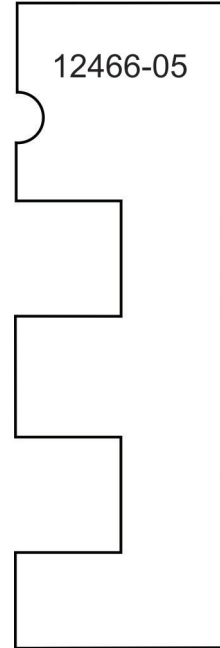
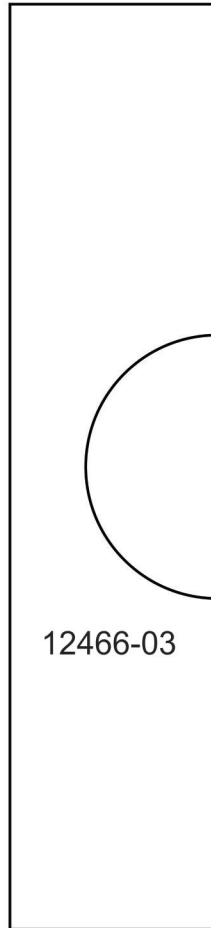
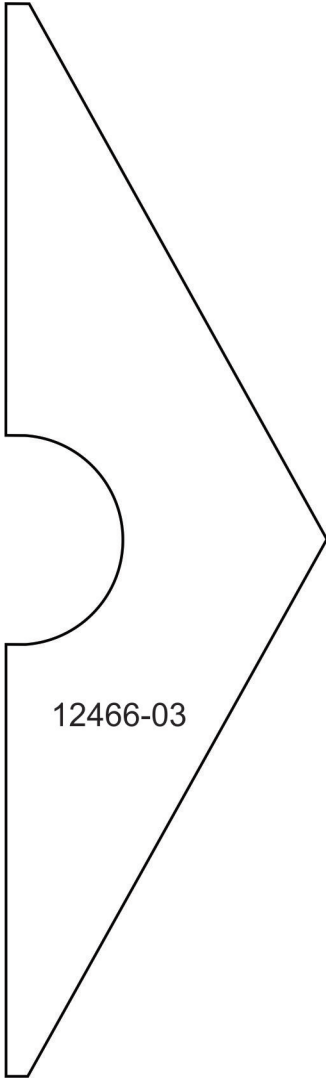

MIRRORED PATTERNS



Print at 100%. No scaling. This box measures 1" x 1". Use the box as an accuracy guide when printing templates.

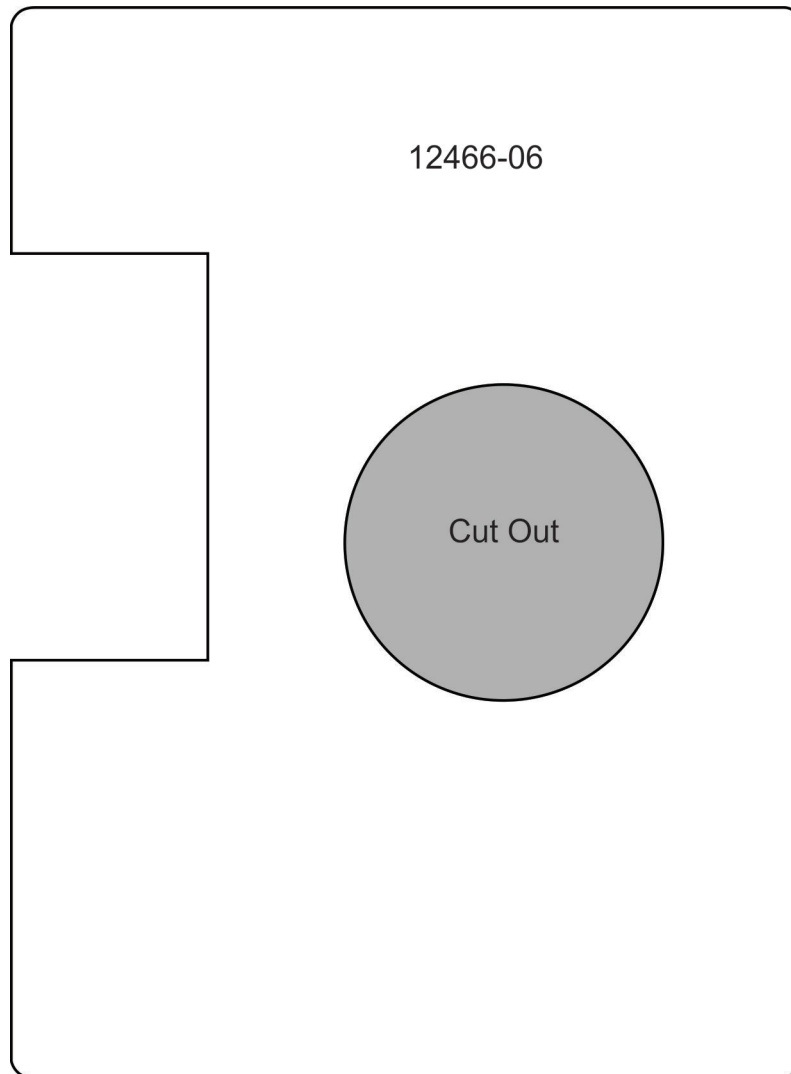

MIRRORED PATTERNS



Print at 100%. No scaling. This box measures 1" x 1". Use the box as an accuracy guide when printing templates.

