

FREESTANDING LACE HAUNTED HOUSE



1
Design

Fits hoop sizes 6" x 10" and larger

THREAD LIST



Isacord Thread Colors

0020 Black

DESIGNS

Note: Some designs in this collection may have been created using unique special stitches and/or techniques. To preserve design integrity when rescaling or rotating designs in your software, always rescale or rotate designs using the handles directly on-screen.

***Fabric Required**



12480-01 Haunted Front Door Wall Applique

Size Inches: Size mm: Stitch Count:
2.86 X 6.98 in. 72.64 X 177.29 mm 23,167 St.

- 1. Wall Placement Stitch..... 0020
- 2. Wall Cut Line & Tackdown..... 0020
- 3. Door Placement Stitch..... 0020
- 4. Door Cut Line & Tackdown..... 0020
- 5. Windows Placement Stitch..... 0020
- 6. Windows Cut Line & Tackdown 0020
- 7. Lace..... 0020

Note: Some designs in this collection may have been created using unique special stitches and/or techniques. To preserve design integrity when rescaling or rotating designs in your software, always rescale or rotate designs using the handles directly on-screen.

***Fabric Required**

12480-02 Haunted Right Wall Applique

Size Inches: Size mm: Stitch Count:
6.02 X 4.38 in. 152.91 X 111.25 mm 32,102 St.



- 1. Wall Placement Stitch..... 0020
- 2. Wall Cut Line & Tackdown..... 0020
- 3. Ghost Placement Stitch..... 0020
- 4. Ghost Cut Line & Tackdown 0020
- 5. Windows Placement Stitch..... 0020
- 6. Windows Cut Line & Tackdown 0020
- 7. Lace..... 0020

***Fabric Required**

12480-03 Haunted Back Wall Applique

Size Inches: Size mm: Stitch Count:
2.86 X 7.00 in. 72.64 X 177.80 mm 11,512 St.

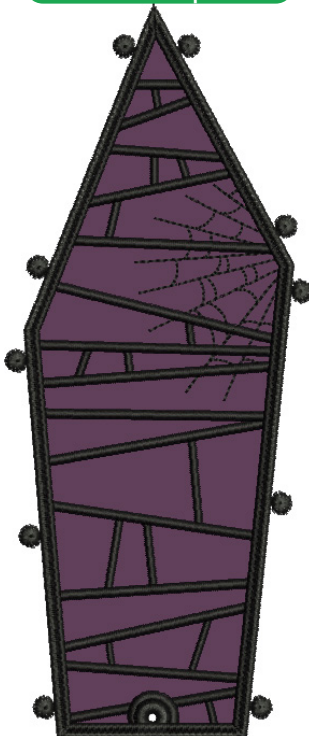

- 1. Wall Placement Stitch..... 0020
- 2. Wall Cut Line & Tackdown..... 0020
- 3. Lace..... 0020

Note: Some designs in this collection may have been created using unique special stitches and/or techniques. To preserve design integrity when rescaling or rotating designs in your software, always rescale or rotate designs using the handles directly on-screen.

***Fabric Required**

12480-04 Haunted Inner Wall Applique

Size Inches: Size mm: Stitch Count:
6.04 X 4.77 in. 153.42 X 121.16 mm 41,654 St.

- 1. Wall Placement Stitch..... 0020
- 2. Wall Cut Line & Tackdown..... 0020
- 3. Lace..... 0020

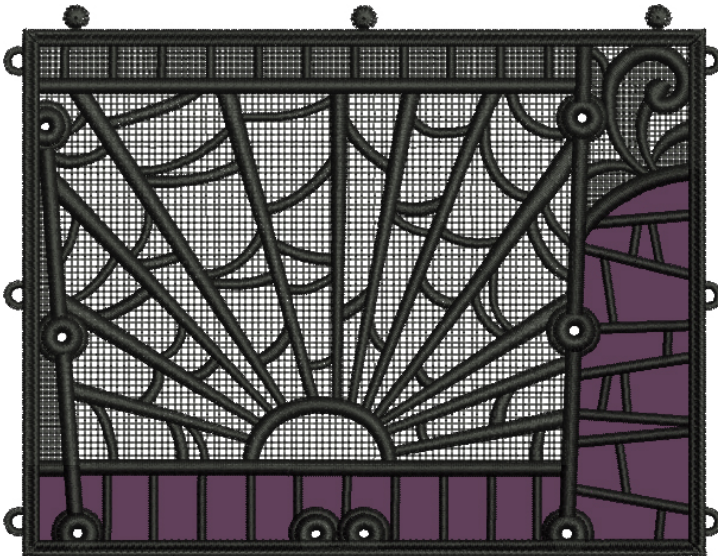

***Fabric Required**

12480-05 Haunted Roof 1 Applique

Size Inches: Size mm: Stitch Count:
6.65 X 4.43 in. 168.91 X 112.52 mm 29,072 St.

- 1. Roof Placement Stitch..... 0020
- 2. Roof Cut Line & Tackdown..... 0020
- 3. Lace..... 0020

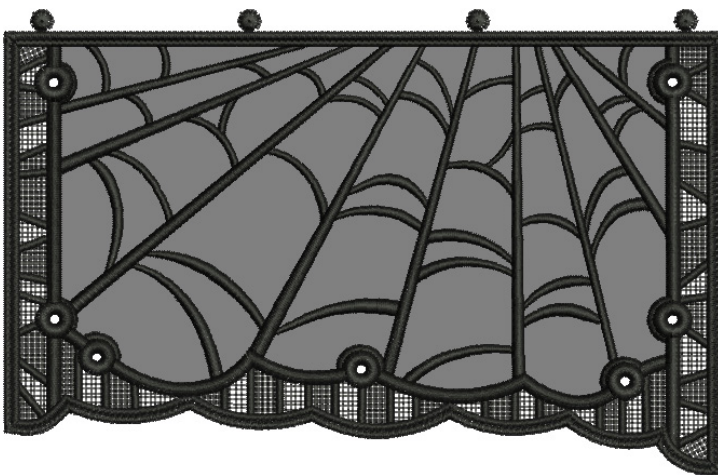

Note: Some designs in this collection may have been created using unique special stitches and/or techniques. To preserve design integrity when rescaling or rotating designs in your software, always rescale or rotate designs using the handles directly on-screen.

***Fabric Required**

12480-06 Haunted Roof 2 Applique

Size Inches: Size mm: Stitch Count:
6.66 X 3.73 in. 169.16 X 94.74 mm 29,147 St.

- 1. Roof Placement Stitch..... 0020
- 2. Roof Cut Line & Tackdown 0020
- 3. Lace..... 0020

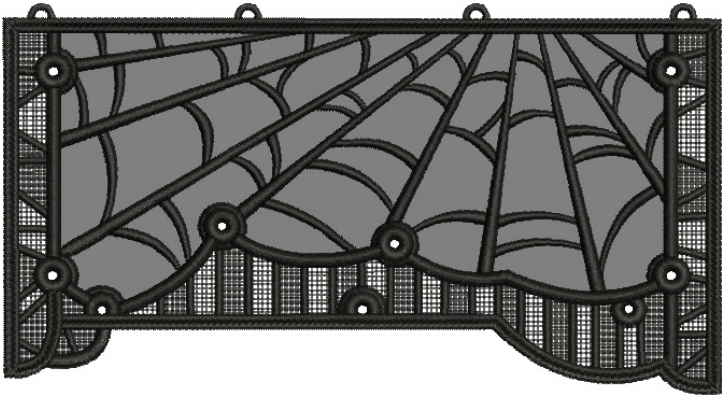

***Fabric Required**

12480-07 Haunted Front Wall Applique

Size Inches: Size mm: Stitch Count:
4.76 X 4.37 in. 120.90 X 111.00 mm 28,236 St.

- 1. Wall Placement Stitch..... 0020
- 2. Wall Cut Line & Tackdown..... 0020
- 3. Window Placement Stitch..... 0020
- 4. Window Cut Line & Tackdown..... 0020
- 5. Lace..... 0020



Note: Some designs in this collection may have been created using unique special stitches and/or techniques. To preserve design integrity when rescaling or rotating designs in your software, always rescale or rotate designs using the handles directly on-screen.

***Fabric Required**



12480-08 Haunted Left Wall Applique

Size Inches: Size mm: Stitch Count:
4.77 X 5.87 in. 121.16 X 149.10 mm 37,807 St.

- 1. Wall Placement Stitch..... 0020
- 2. Wall Cut Line & Tackdown..... 0020
- 3. Door Placement Stitch..... 0020
- 4. Door Cut Line & Tackdown..... 0020
- 5. Window Placement Stitch..... 0020
- 6. Window Cut Line & Tackdown..... 0020
- 7. Lace..... 0020

***Fabric Required**



12480-09 Haunted Back Door Wall Applique

Size Inches: Size mm: Stitch Count:
4.74 X 4.17 in. 120.40 X 105.92 mm 22,041 St.

- 1. Wall Placement Stitch..... 0020
- 2. Wall Cut Line & Tackdown..... 0020
- 3. Door Placement Stitch..... 0020
- 4. Door Cut Line & Tackdown..... 0020
- 5. Window Placement Stitch..... 0020
- 6. Window Cut Line & Tackdown..... 0020
- 7. Lace..... 0020

Note: Some designs in this collection may have been created using unique special stitches and/or techniques. To preserve design integrity when rescaling or rotating designs in your software, always rescale or rotate designs using the handles directly on-screen.

***Fabric Required**

12480-10 Haunted Roof 3 Applique

Size Inches: Size mm: Stitch Count:
5.17 X 3.61 in. 131.32 X 91.69 mm 20,911 St.

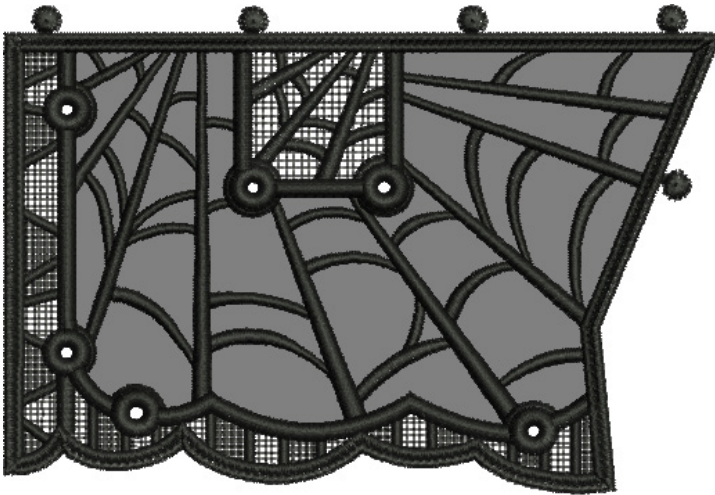

- 1. Roof Placement Stitch..... 0020
- 2. Roof Cut Line & Tackdown 0020
- 3. Lace..... 0020

***Fabric Required**

12480-11 Haunted Roof 4 Applique

Size Inches: Size mm: Stitch Count:
5.17 X 3.79 in. 131.32 X 96.27 mm 21,190 St.

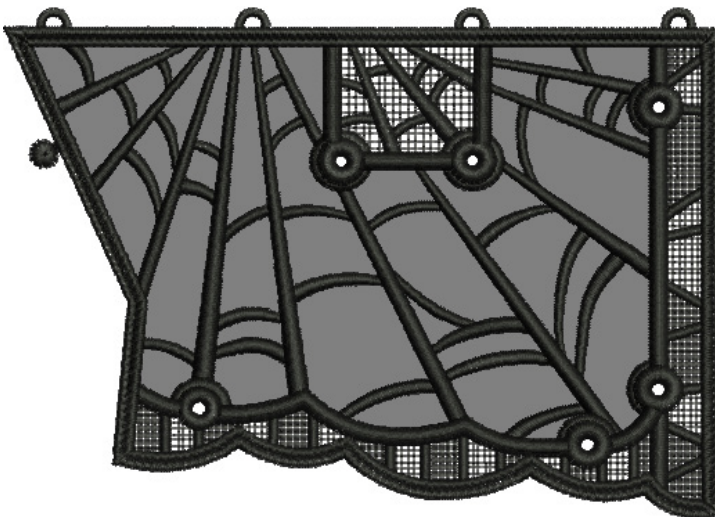

- 1. Roof Placement Stitch..... 0020
- 2. Roof Cut Line & Tackdown 0020
- 3. Lace..... 0020

Note: Some designs in this collection may have been created using unique special stitches and/or techniques. To preserve design integrity when rescaling or rotating designs in your software, always rescale or rotate designs using the handles directly on-screen.

***Fabric Required**

12480-12 Haunted Upper Room Applique

Size Inches: Size mm: Stitch Count:
6.81 X 3.98 in. 172.97 X 101.09 mm 19,466 St.



- 1. Tall Walls Placement Stitch 0020
- 2. Tall Walls Cut Line & Tackdown..... 0020
- 3. Short Walls Placement Stitch 0020
- 4. Short Walls Cut Line & Tackdown 0020
- 5. Window Placement Stitch..... 0020
- 6. Window Cut Line & Tackdown..... 0020
- 7. Lace..... 0020

***Fabric Required**

12480-13 Haunted Roof 5 Applique

Size Inches: Size mm: Stitch Count:
2.44 X 4.85 in. 61.98 X 123.19 mm 21,482 St.

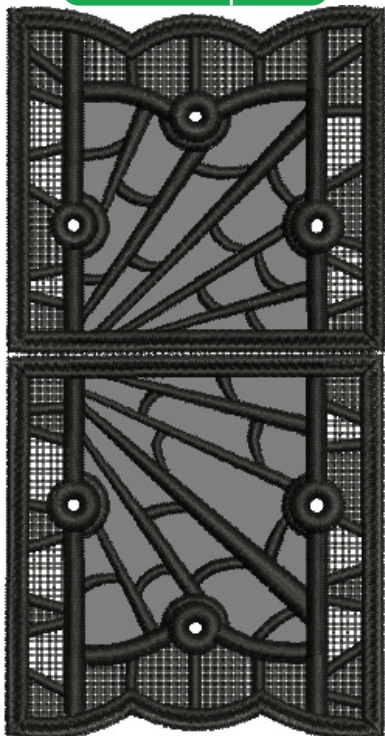

- 1. Roof Placement Stitch..... 0020
- 2. Long Side Cut Line & Tackdown 0020
- 3. Short Side Cut Line & Tackdown..... 0020
- 4. Lace..... 0020

Note: Some designs in this collection may have been created using unique special stitches and/or techniques. To preserve design integrity when rescaling or rotating designs in your software, always rescale or rotate designs using the handles directly on-screen.

***Fabric Required**

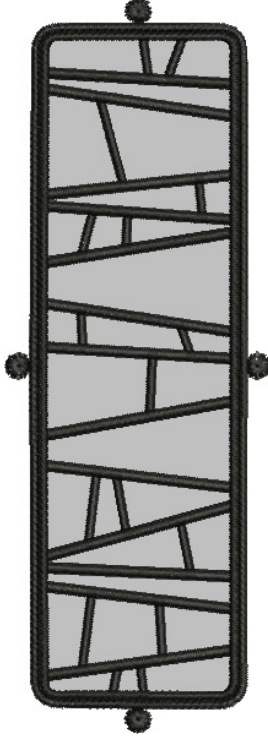

12480-14 Haunted Foundation 1 Applique

Size Inches: Size mm: Stitch Count:
2.16 X 6.15 in. 54.86 X 156.21 mm 9,231 St.

- 1. Floor Placement Stitch 0020
- 2. Floor Cut Line & Tackdown 0020
- 3. Lace..... 0020

***Fabric Required**

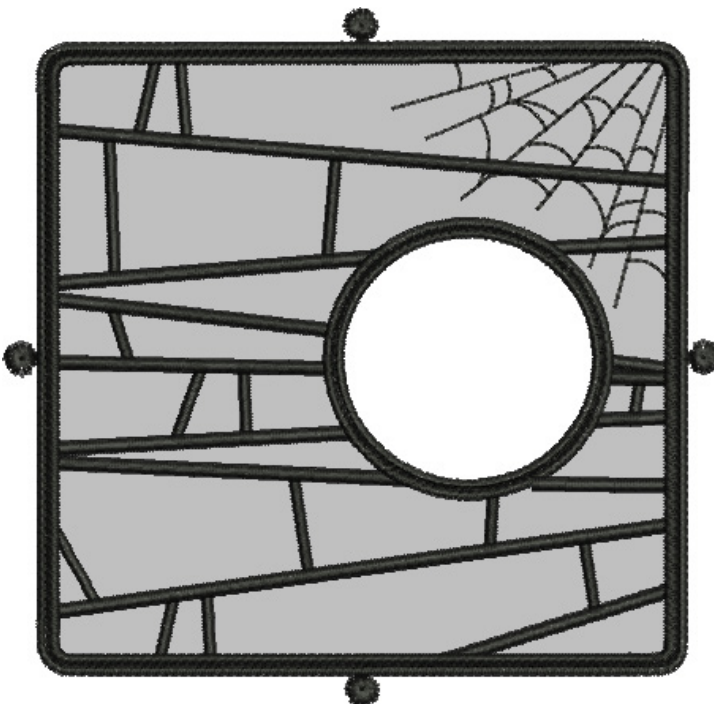

12480-15 Haunted Foundation 2 Applique

Size Inches: Size mm: Stitch Count:
4.53 X 4.53 in. 115.06 X 115.06 mm 12,076 St.

- 1. Floor Placement Stitch 0020
- 2. Floor Cut Line & Tackdown 0020
- 3. Lace..... 0020

COLLECTION SUPPLIES



Stabilizer

- AquaMesh WashAway
- BadgeMaster
- StabliStick CutAway

Supplies

- Fabric for Applique: deep purple for walls, gold organza for the windows, light charcoal for the roof and light gray for the doors about an 1/8 yd. of each color.
- Embroidery thread per chart
- Alligator Clamps
- Expert Embroidery Tape TearAway
- Optional: Button Clips

NOTE

- The design in the photos is 12480-01. Applique techniques are the same for all of the designs. Stitch one of each design.
- Match bobbin thread to all top threads in the designs.

STEP 1

- Cut applique fabrics slightly larger than needed. Prep fabric by applying 2 sheets of StabilStick CutAway to the wrong side of the cotton fabric. **DO NOT** apply StabilStick to the organza.
- Note – this stabilizes your fabric, so it produces a nice, crisp project.



STEP 2

- Hoop 1 piece of AquaMesh and 1 piece of BadgeMaster.
- Stitch Machine Step 1, Wall Placement Stitch.

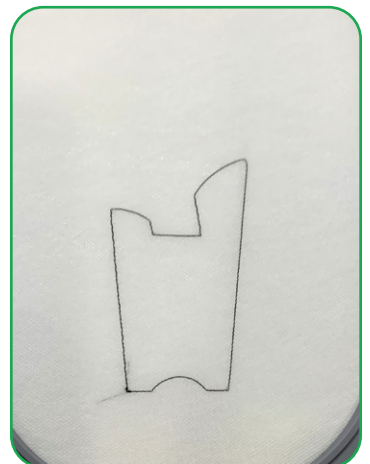

STEP 3

- Place fabric over placement stitch, make sure to cover stitches completely.
- Optional – use Expert Embroidery Tape TearAway to hold items in place.
- Stitch Machine Step 2, the Wall Cut Line & Tackdown.
- Note - Gold thread used for visibility.

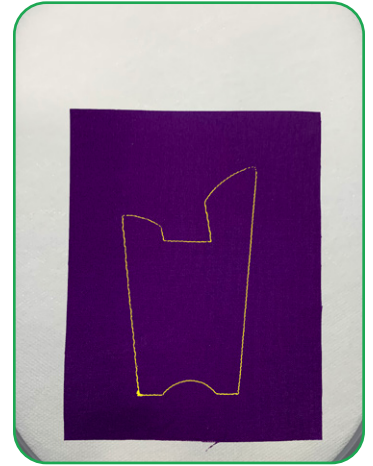

STEP 4

- Remove hoop from machine, DO NOT unhoop fabric/stabilizer.
- Trim along cut line. Return the hoop to the machine.



STEP 5

- Stitch Machine Step 3, the Door Placement Stitch.
- Place fabric over placement stitch as pictured, make sure to cover door placement completely.
- Tape in place.



STEP 6

- Stitch Machine Step 4, the Door Cut Line and Tackdown.
- Remove hoop from machine, DO NOT unhoop fabric/stabilizer.

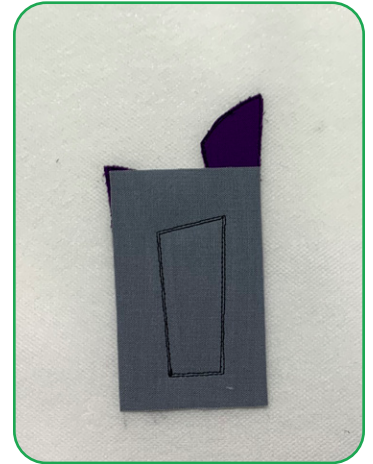

STEP 7

- Trim along cut line.
- Return the hoop to the machine.



STEP 8

- Stitch Machine Step 5, the Window Placement Stitch.



STEP 9

- Place the organza fabric over placement stitch as pictured, make sure to cover the window placements completely.
- Stitch Machine Step 6, the Window Cut Line and Tackdown.

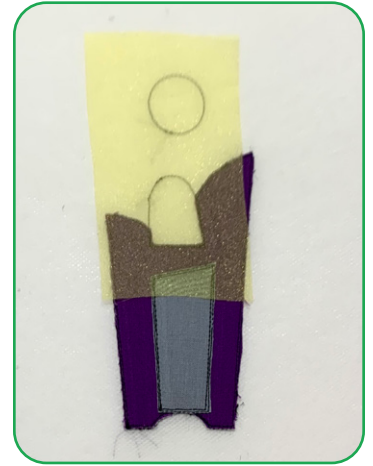

STEP 10

- Remove hoop from machine, DO NOT unhoop fabric/stabilizer.
- Trim along cut line.
- Return the hoop to the machine.



STEP 11

- Stitch Machine Step 7, the Black Lace & Detail.



STEP 12

- Remove from hoop, trim the stabilizers $\frac{1}{2}$ " away from the design. Be careful NOT to cut your eyelets or buttonettes!
- Wash away stabilizer and let dry face down.
- Tip: Rinse out the stabilizer in warm running water. Only rinse until it is slightly sticky. This will give the design more stiffness.



ASSEMBLY



STEP 1

- Connect right wall of the Upper Room (12480-12) with the back wall of the Upper Room by inserting the two buttonettes along the right wall into the two back wall eyelets.



STEP 2

- Attach Roof 5 (12480-13) to the Upper Room walls – attach long side of roof to long slant by inserting the four buttonettes into the four eyelets and short side to the short slant by inserting the two buttonettes into the two eyelets.

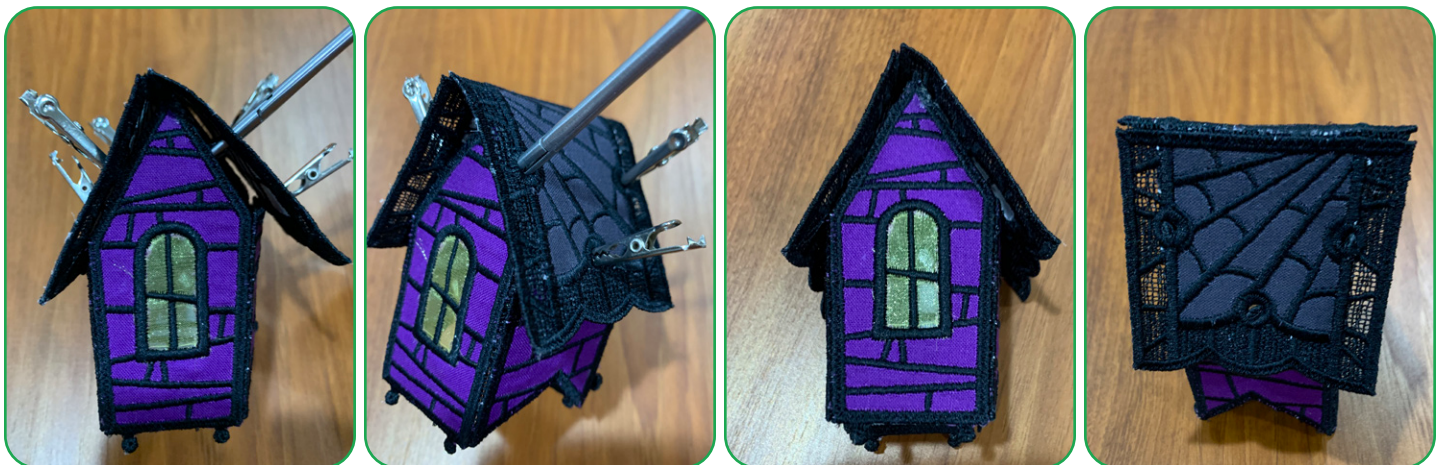

ASSEMBLY



STEP 3

- Connect edge of Roof 3 (12480-10) to Roof 4 (12480-11) by inserting the four buttonettes into the four eyelets.



STEP 4

- Connect front of the upper room structure (with window) into the two eyelets on Roof 3.



STEP 5

- Connect back of the upper room structure into the two eyelets on Roof 4.



ASSEMBLY



STEP 6

- Set aside built upper room and left roof structure.



STEP 7

- Connect left edge of Front Door Wall (12480-01) to the right edge of the Inner Wall. (12480-04)



STEP 8

- Connect right edge of Front Door Wall (12480-01) to the left edge of the Right Wall.

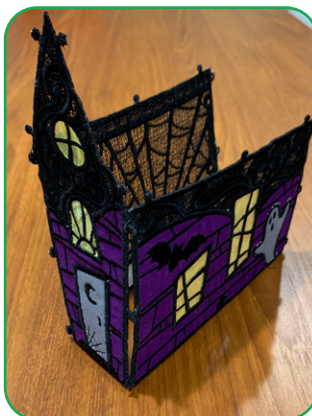

STEP 9

- Connect right edge of Back Wall (12480-03) to left edge of the Inner Wall (12480-04).
- Set aside built right room structure.



STEP 10

- Connect edge of Roof 1 (12480-05) to edge of Roof 2 (12480-06) by inserting the four buttonettes into the four eyelets.



STEP 11

- Connect left edge of Front Wall (12480-07) to right edge of Left Wall (12480-08) by inserting the three buttonettes into the three eyelets.



ASSEMBLY



STEP 12

- Connect left edge of Left Wall (12480-08) to right edge of Back Door Wall (12480-09) by inserting the three buttonettes into the three eyelets.



STEP 13

- Connect the right edge of Front Wall (12480-07) into the three eyelets going down the right-side interior of the Inner Wall (12480-04) by inserting the three buttonettes into the three eyelets.

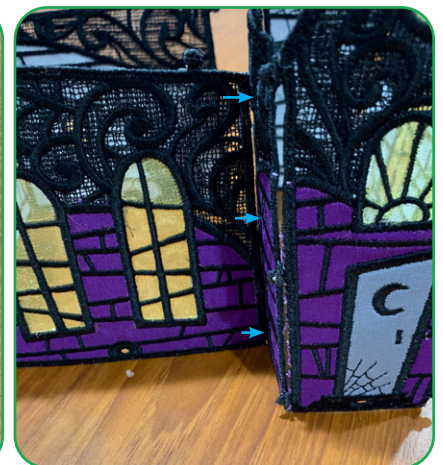

ASSEMBLY



STEP 14

- Connect the left edge of the Back Door Wall (12480-09) into the three holes going down the left side interior of the Inner Wall (12480-04) by inserting the three buttonettes into the three eyelets.



STEP 15

- Connect right edge of Right Wall (12480-02) to left edge of Back Wall (12480-03) by inserting the three buttonettes into the three eyelets.

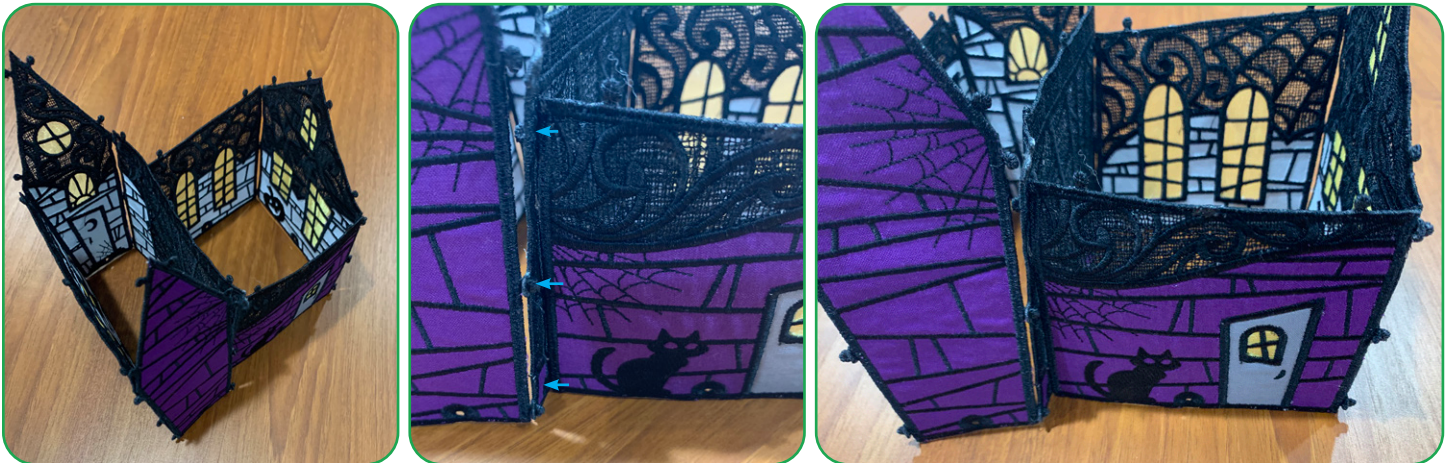

ASSEMBLY



STEP 16

- Connect top buttonette on left side of Front Door (12480-01) into eyelet at top right interior of Roof 2 (12480-06).



STEP 17

- Connect top buttonette on right side of Back Wall (12480-03) into eyelet at top left interior of Roof 2 (12480-06).

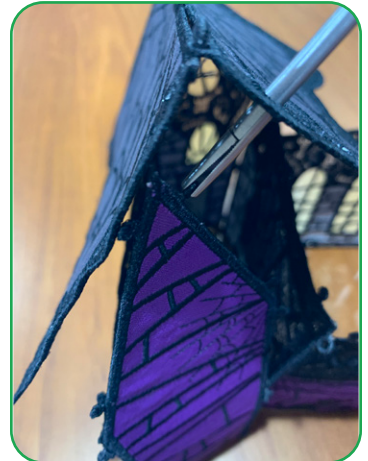

STEP 18

- Connect top edge of Inner Wall (12480-04) into eyelet at top left interior of Roof 2 (12480-06).

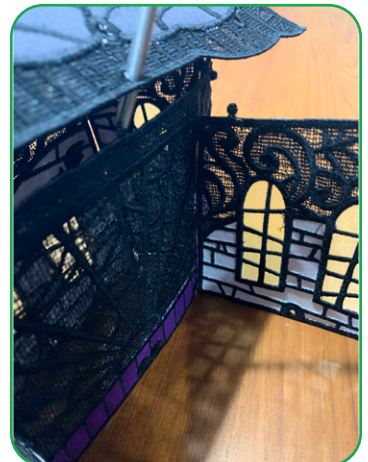

STEP 19

- Connect remaining edge of Inner Wall (12480-04) in to eyelets at the bottom of Roof 2 (12480-06).
- Connect remaining buttonettes on left side of Front Door (12180-01) into eyelet on Roof 2 (12480-06).

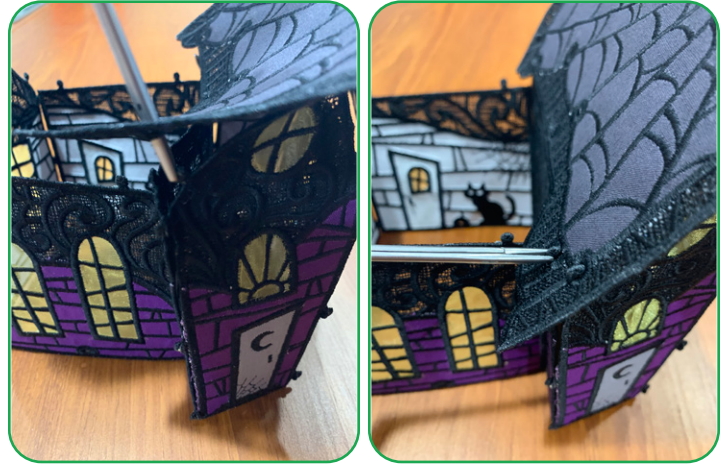

STEP 20

- Connect remaining buttonettes on right side of Back Wall (12480-03) into eyelets on Roof 2 (12480-06).



ASSEMBLY



STEP 21

- Connect Buttonette on top right of Front Wall (12480-07) into bottom right eyelet of Roof 3 (12480-10).

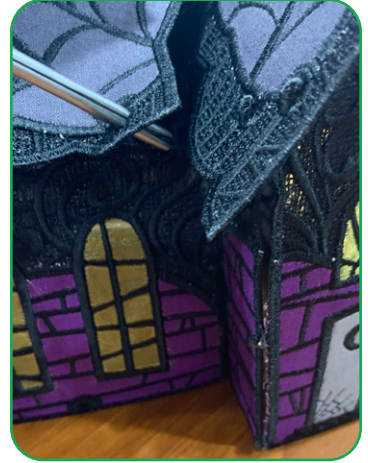

STEP 22

- Connect buttonette on top left of Back Door Wall (12480-09) into bottom left eyelet of Roof 4 (12480-11).



STEP 23

- Connect buttonettes on top right of Left Wall (12480-08) into eyelets of Roof 3 (12480-10).

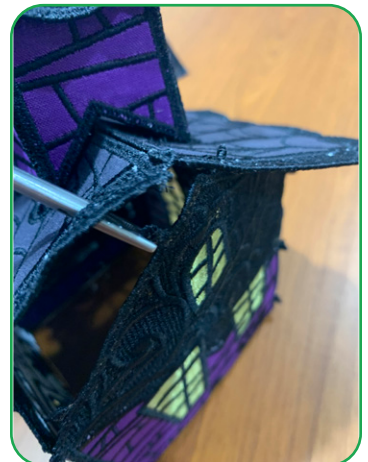

ASSEMBLY



STEP 24

- Connect buttonettes on top right of Left Wall (12480-08) into eyelets on Roof 4 (12480-11).



STEP 25

- Connect buttonette on top left of Front Wall (12480-07) into eyelet on Roof 3 (12480-10).
- Connect buttonette on top right of Back Door Wall (12480-09) into eyelet on Roof 4 (12480-11).
- Attach Left Roof Structure on Right Roof Structure
- Connect buttonette on right edge of Roof 3 (12480-10) into eyelet on Roof 2 (12480-06).

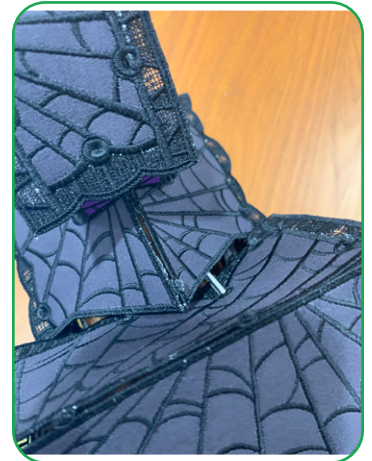

STEP 26

- Connect buttonette on top right of Back Door Wall (12480-09) into eyelet on Roof 4 (12480-11).

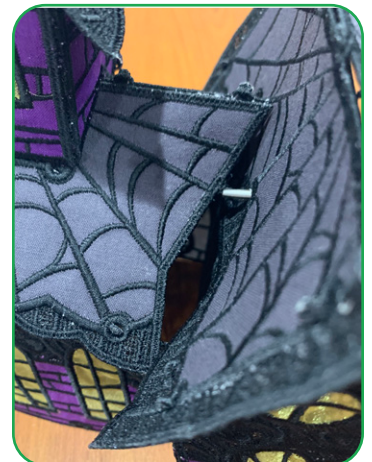

ASSEMBLY



STEP 27

- Attach Roof 1 to Right Roof Structure.
- Connect buttonette on top right of Front Door Wall (12480-01) into top left eyelet of Roof 1 (12480-05).



STEP 28

- Connect buttonette on top left of Back Wall (12480-03) into top right eyelet of Roof 1 (12480-05).



STEP 29

- Connect buttonettes on top edge of Right Wall (12480-02) into eyelets on the bottom of Roof 1 (12480-05).



STEP 30

- Connect remaining buttonette on right edge of Front Door Wall (12480-01) into eyelet on Roof 1 (12480-05).
- Connect remaining buttonette on left edge of Back Wall (12480-03) into eyelet on Roof a (12480-05).



STEP 31

- Appliqué side facing up, connect buttonettes on Foundation 1 (12480-14) into eyelets of the right room structure except for the connection to the Inner Wall (12480-04).



ASSEMBLY



STEP 32

- Appliqué side facing up, connect buttonettes of Foundation 2 (12480-15) into eyelets of the left room structure except for the connection to the Inner Wall (12480-14).



STEP 33

- Connect remaining buttonette on Foundation 1 into the eyelet that is aligned to the Inner Wall (12480-04).



STEP 34

- Connect remaining buttonette on Foundation 2 into the eyelet that is aligned on the Inner Wall (12480-04).



ATTENTION

When printing this document, any page scaling or page fitting options in your print dialog box must be turned OFF or set to NONE so that your files will print out at their actual size. Images not printed at actual size will not function as intended.

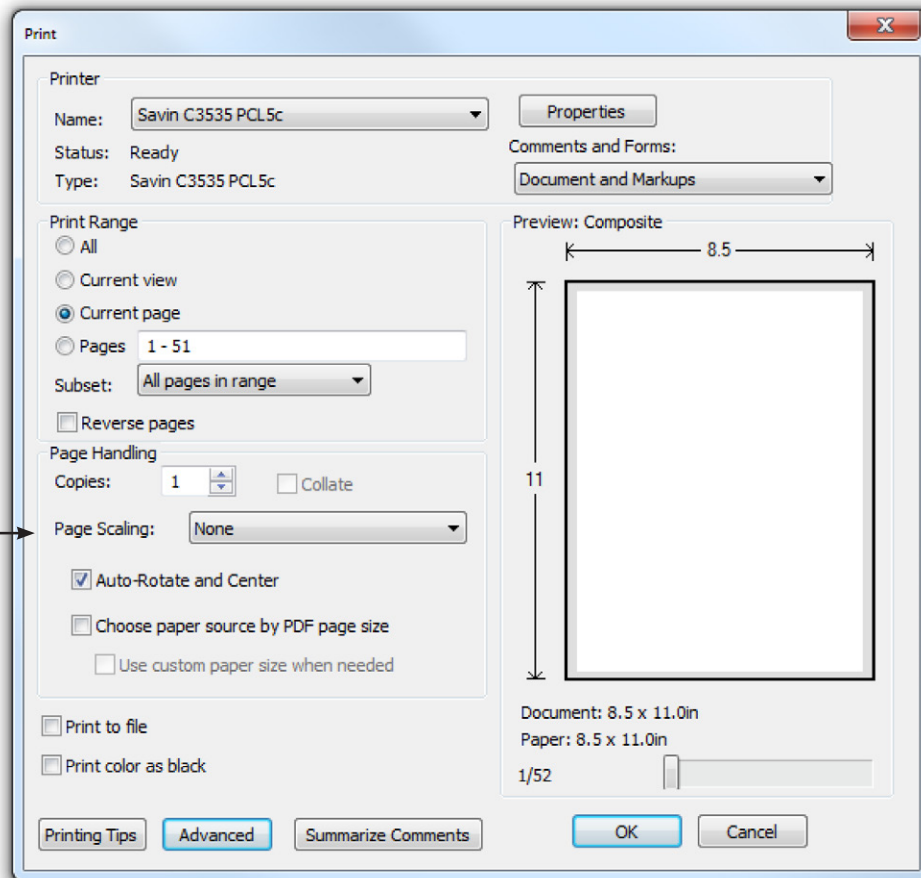

TO SAVE PAPER

Only print the desired image by navigating to the image's page, go to File > Print and select "Current page" in the print dialog box. Repeat for each desired image.

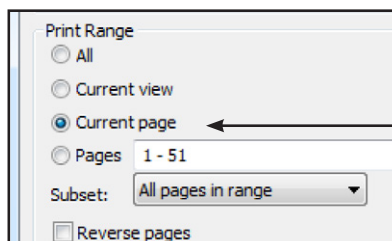

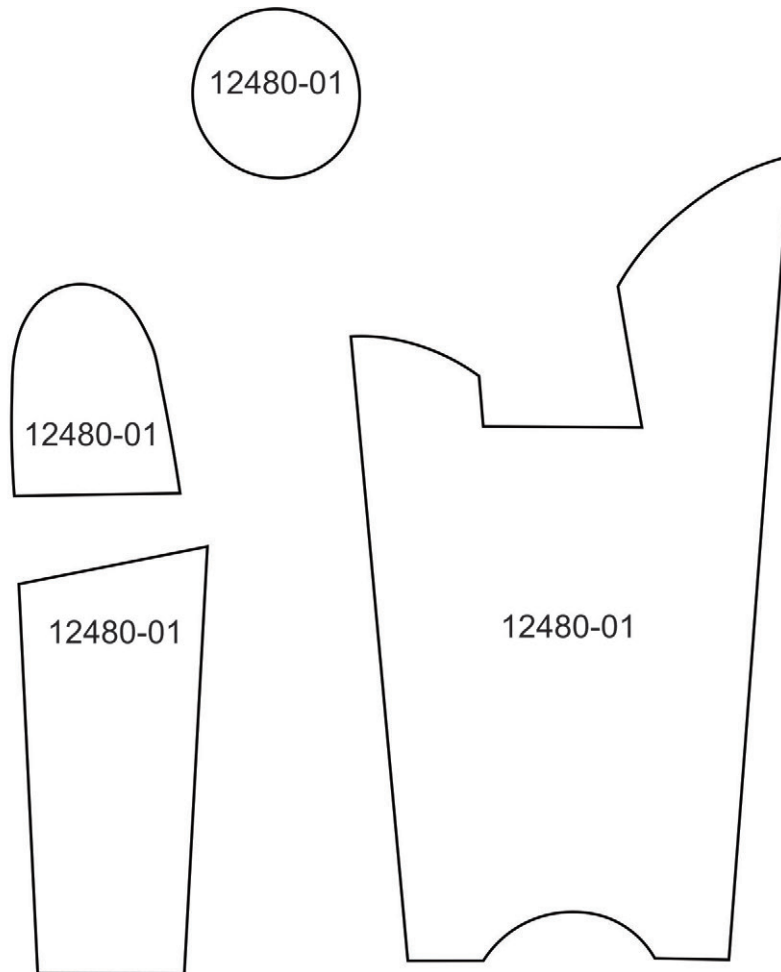

APPLIQUE PATTERNS

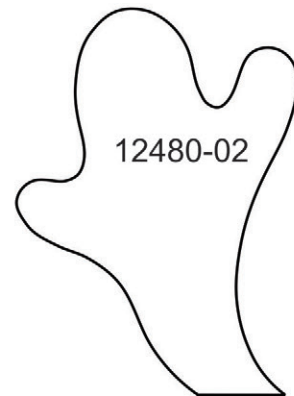
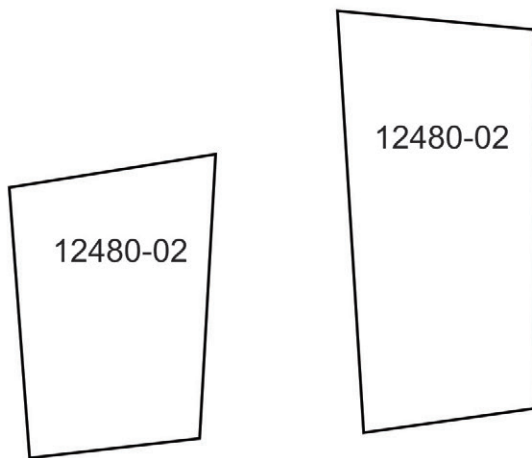
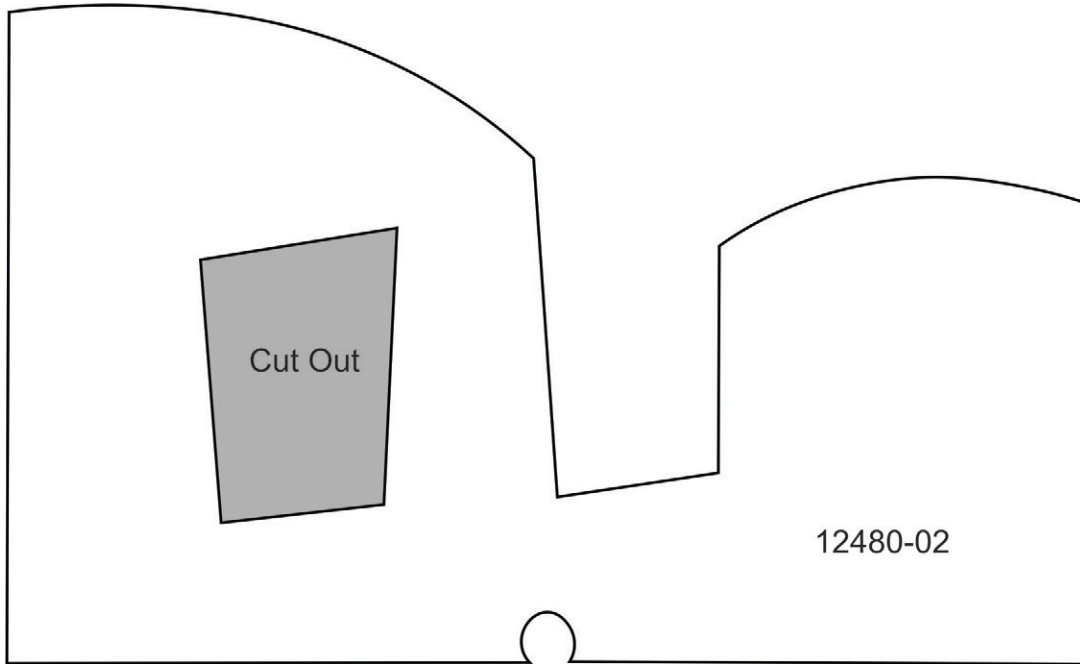

APPLIQUE PATTERNS

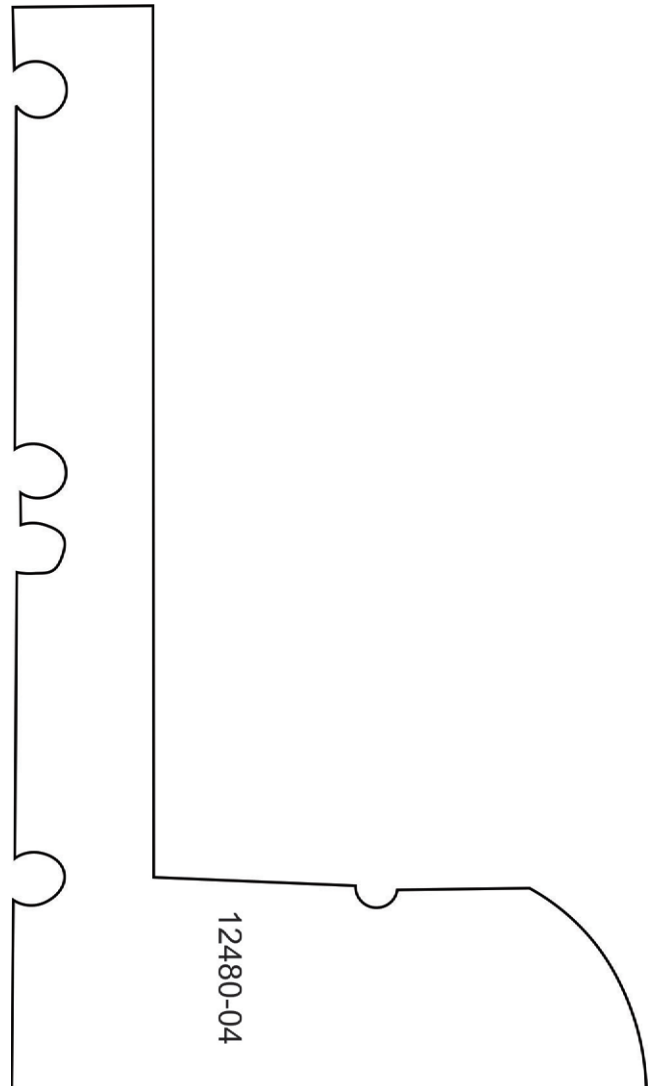
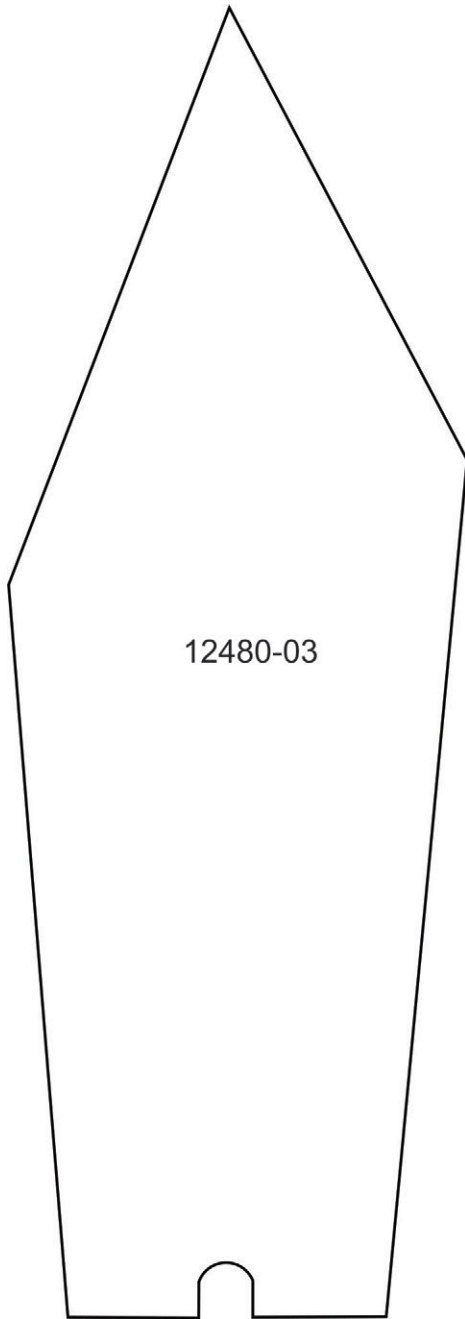

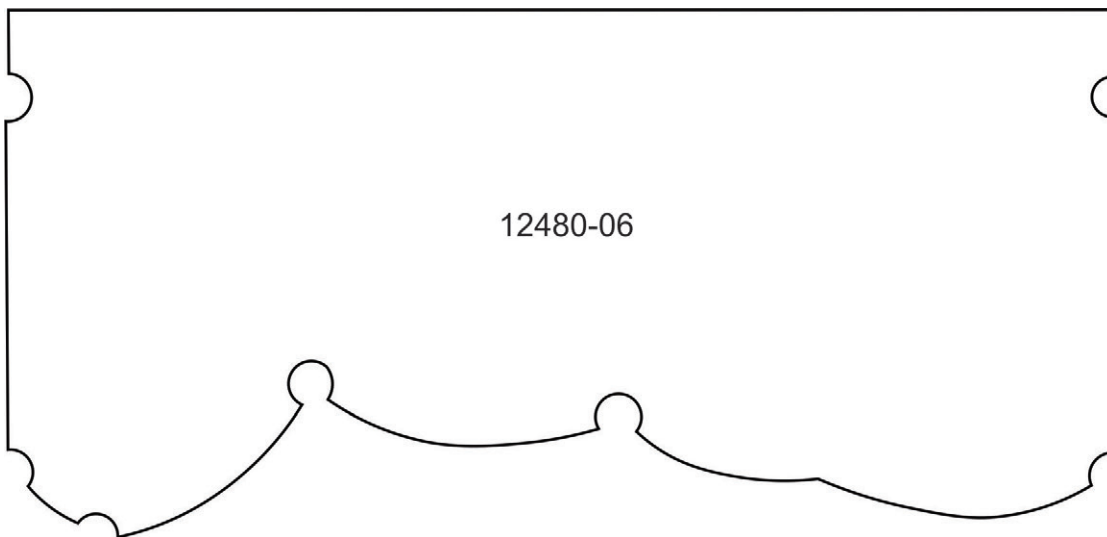
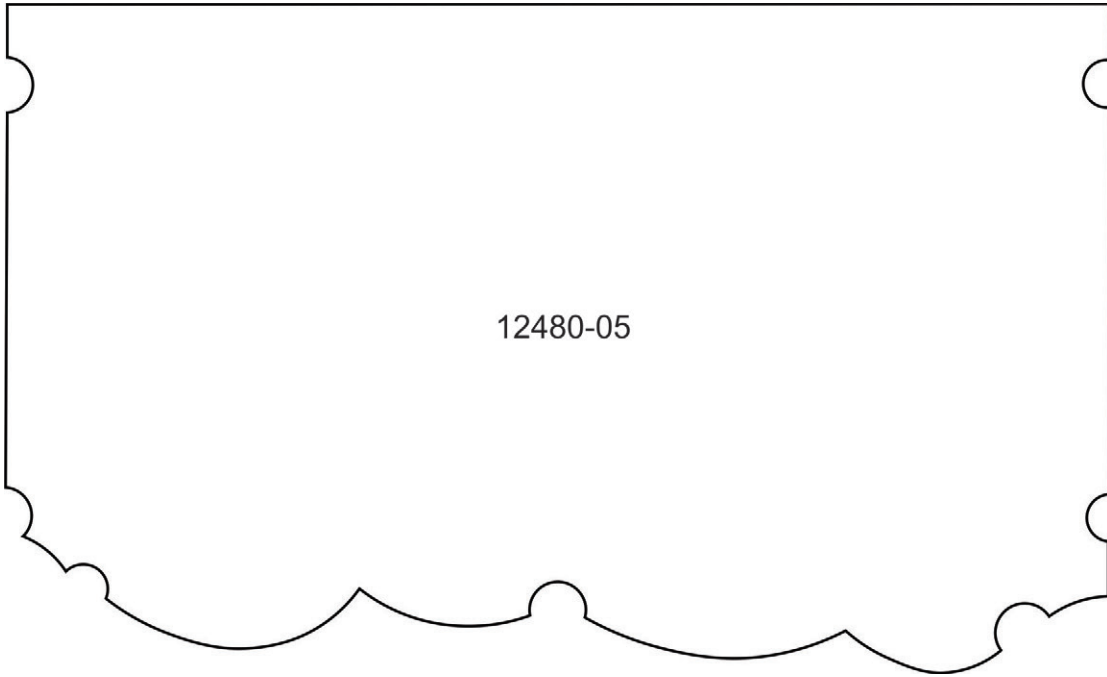

APPLIQUE PATTERNS

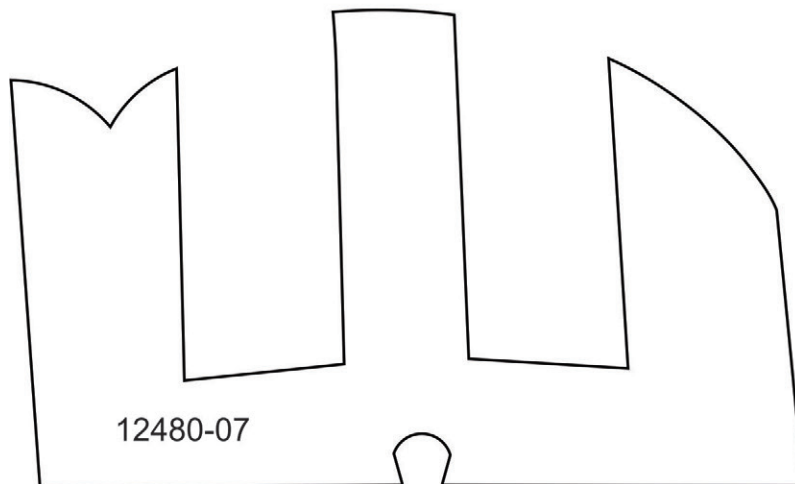
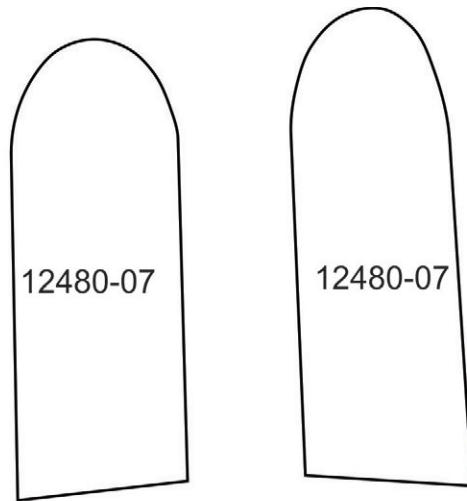

APPLIQUE PATTERNS

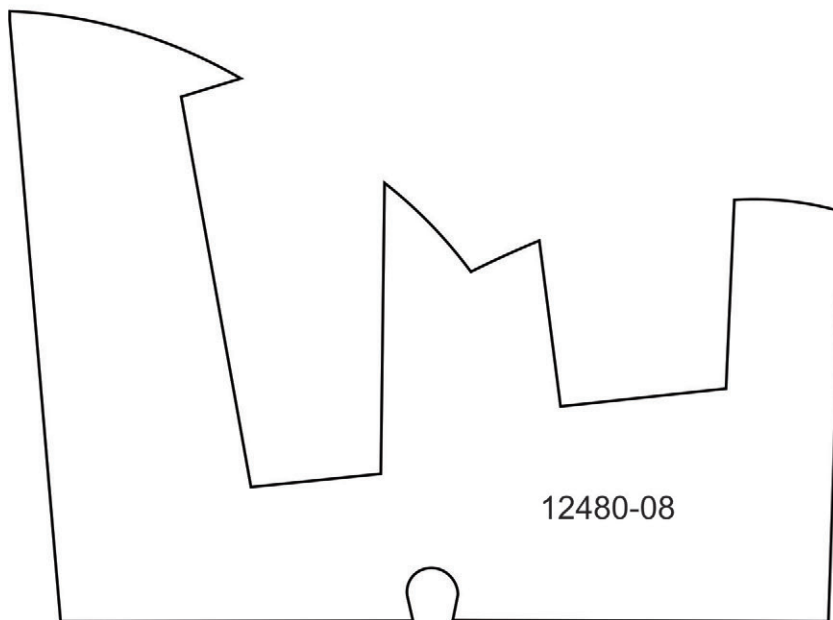
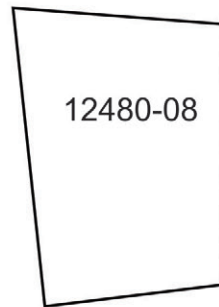
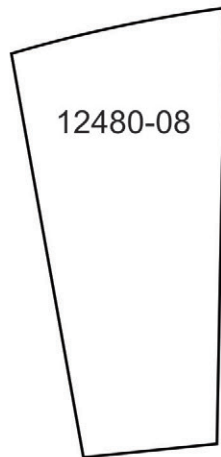

APPLIQUE PATTERNS

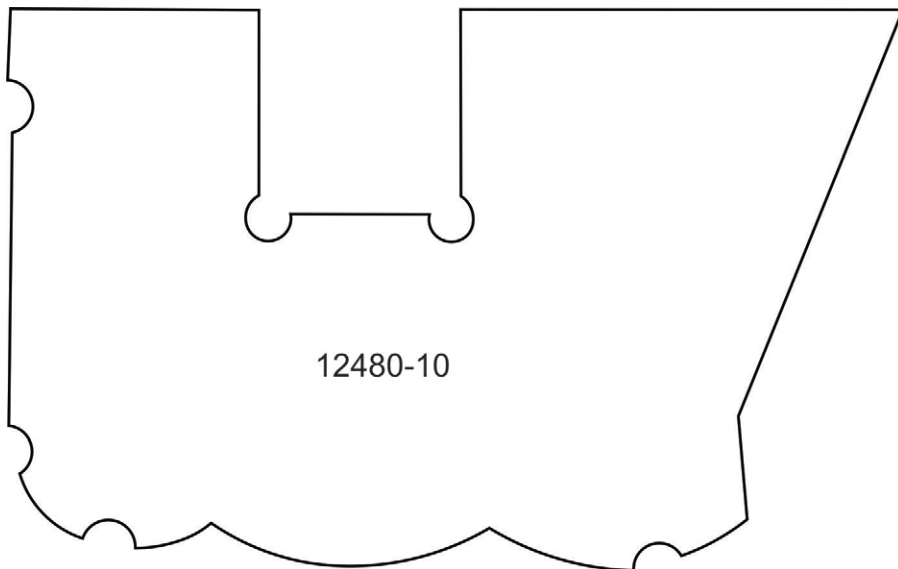
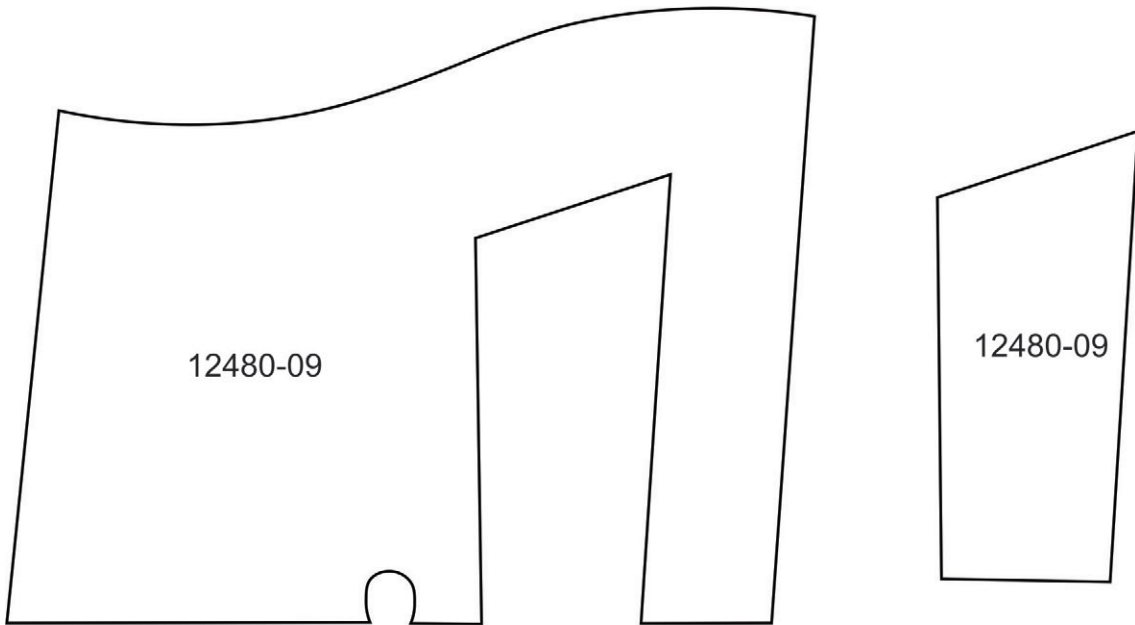

APPLIQUE PATTERNS

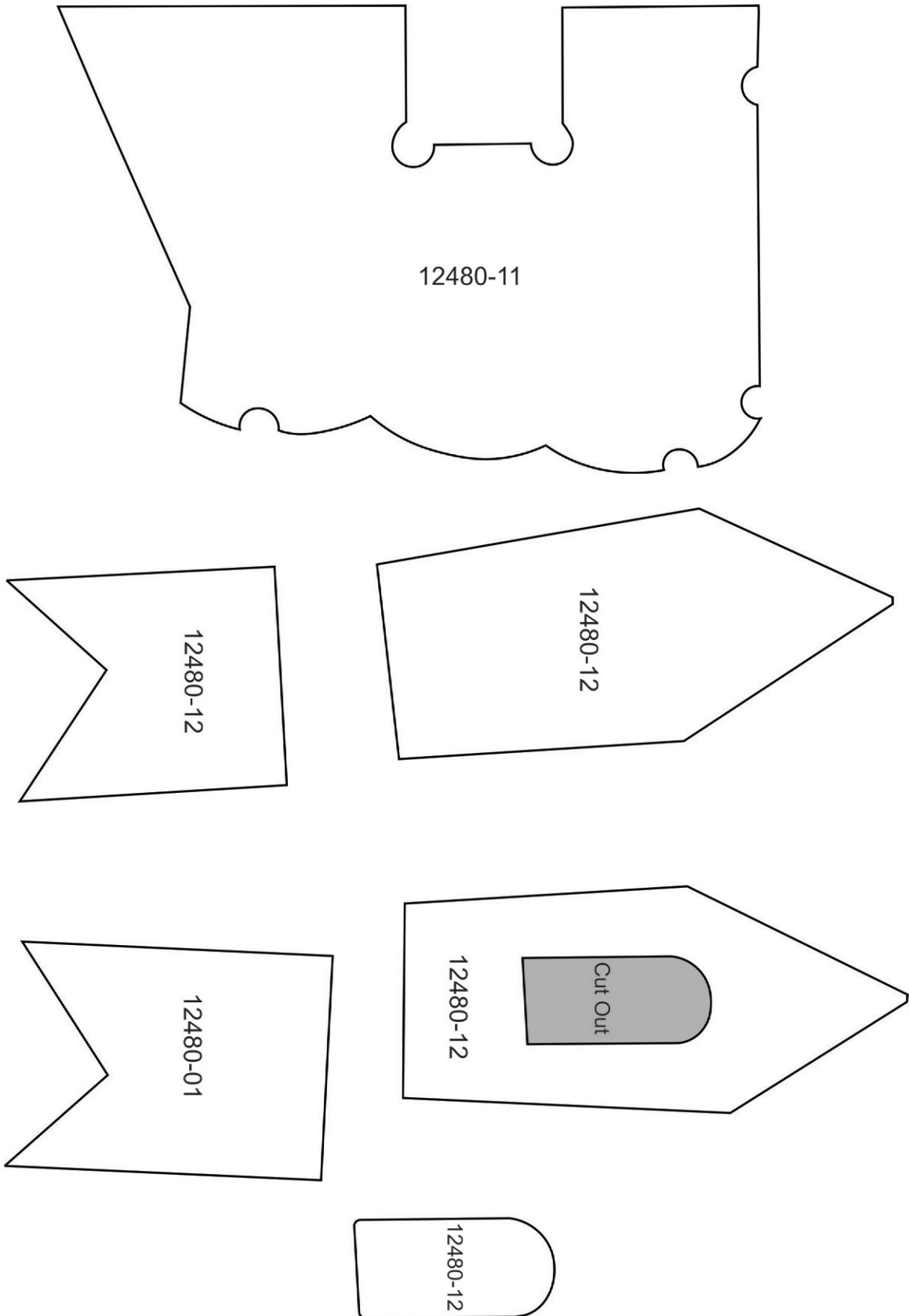

APPLIQUE PATTERNS

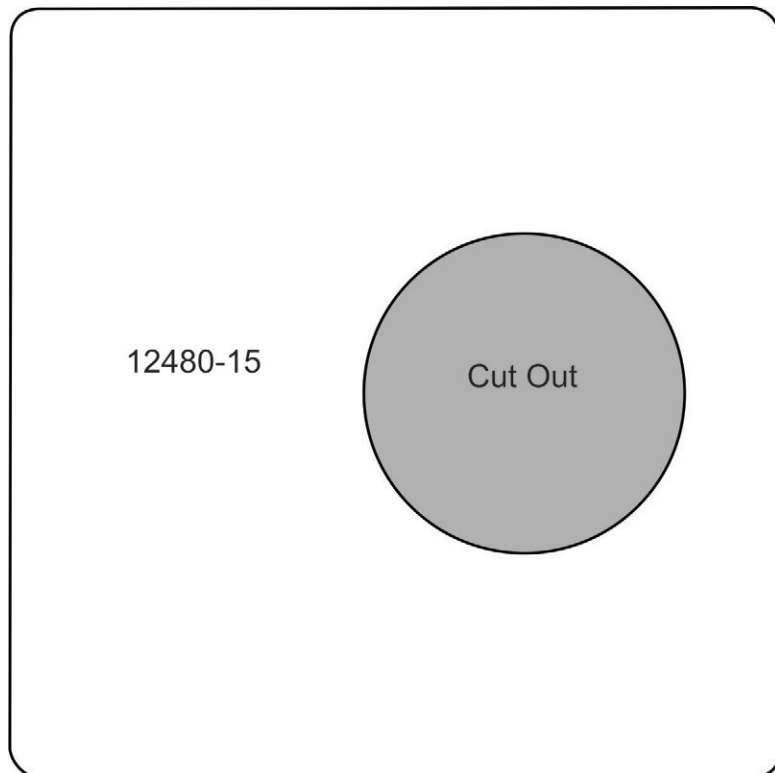
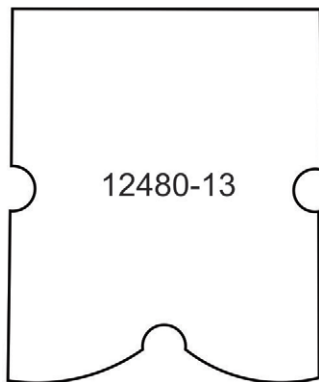
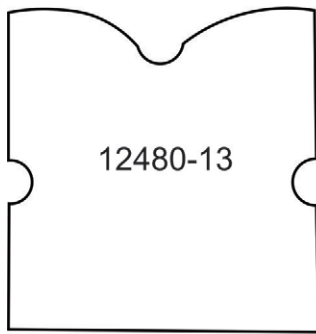
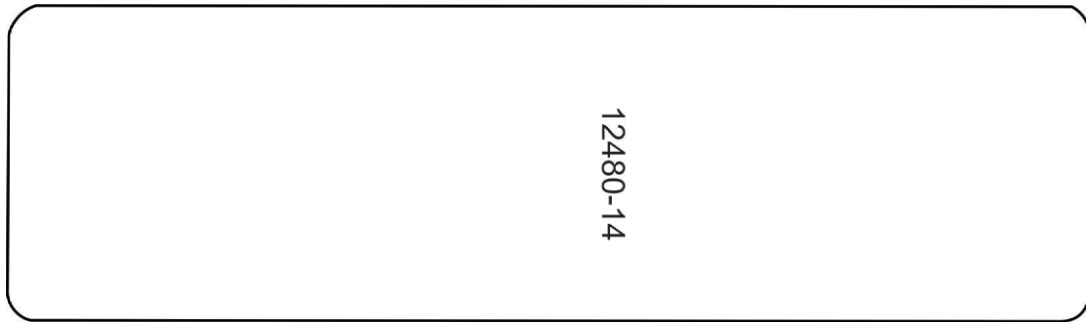

MIRRORED PATTERNS

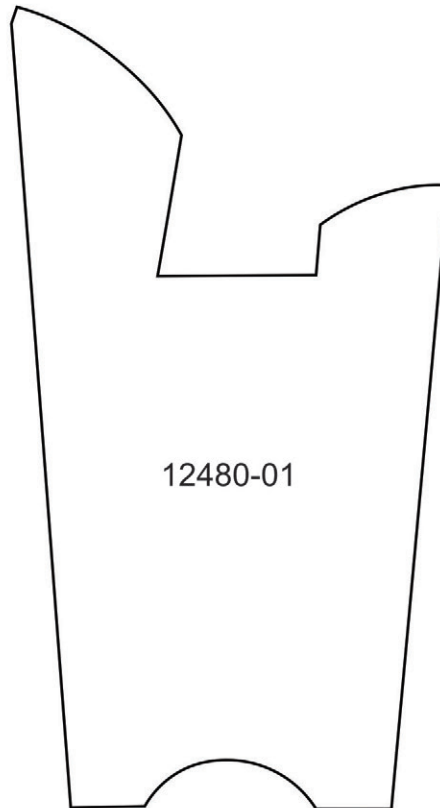
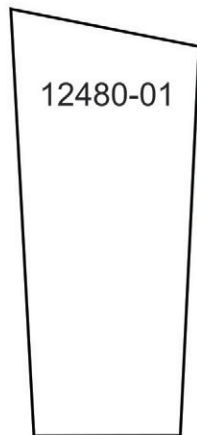
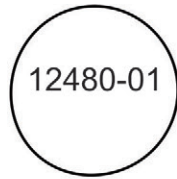

MIRRORED PATTERNS

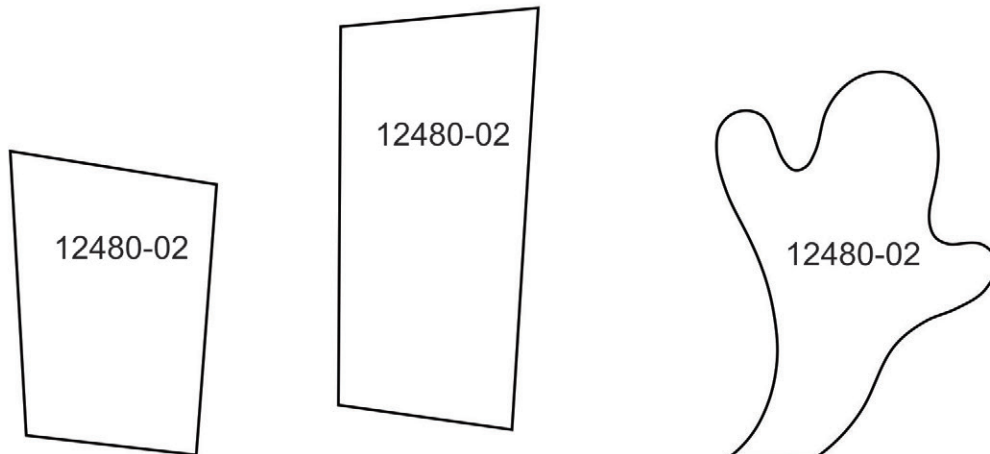
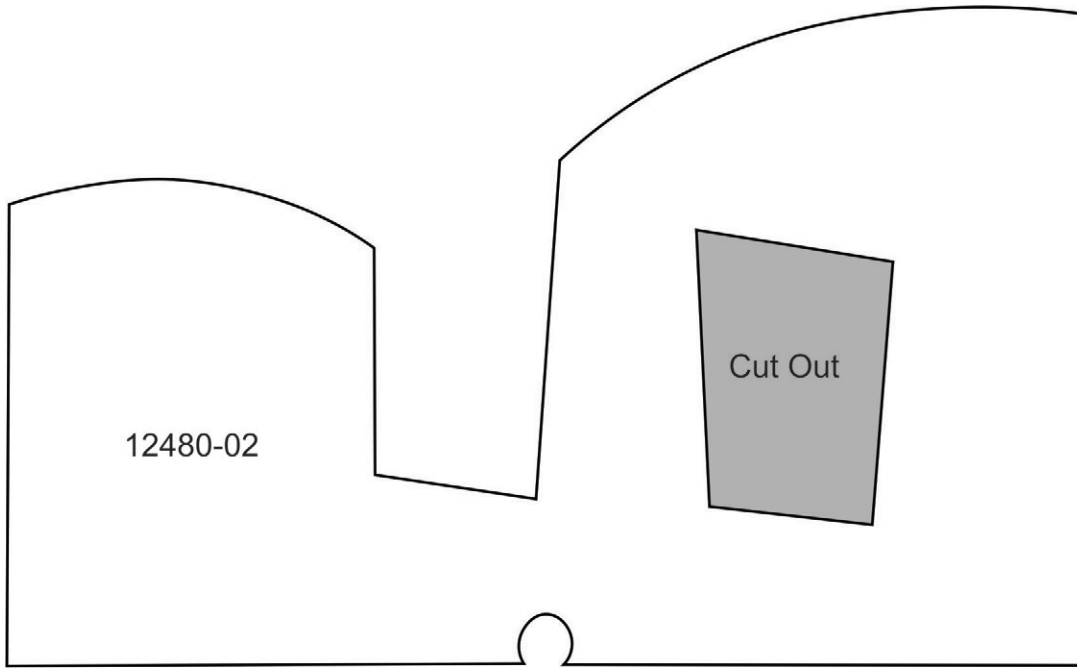

MIRRORED PATTERNS

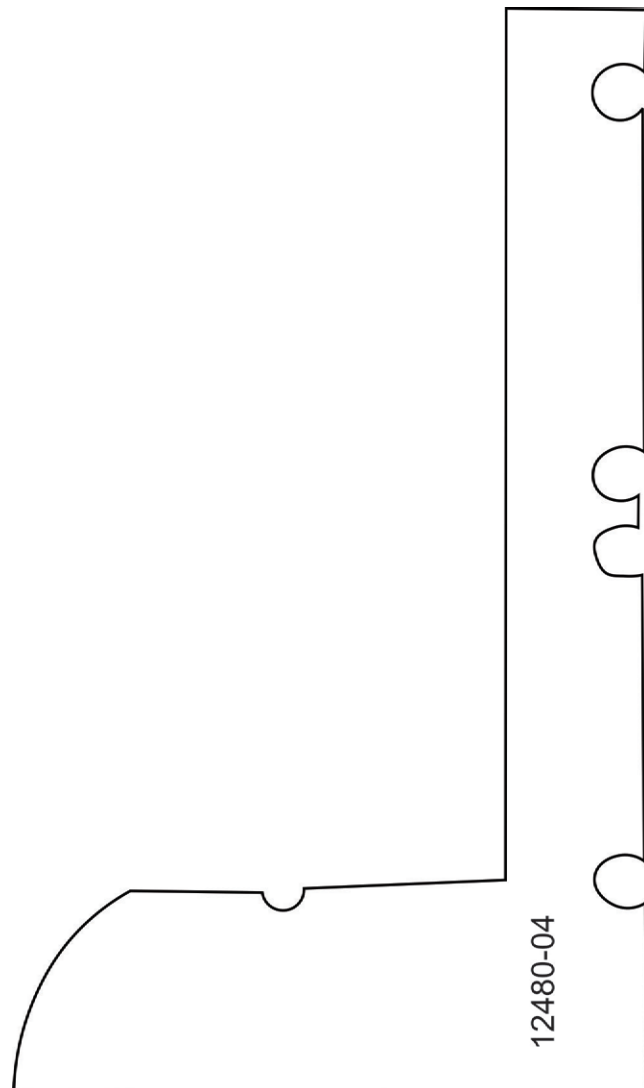
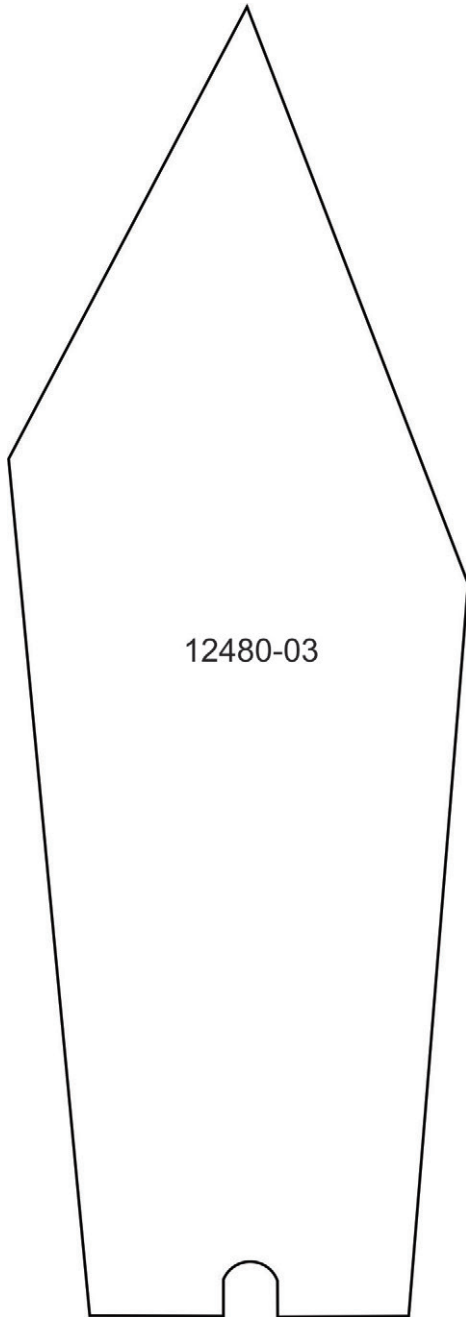

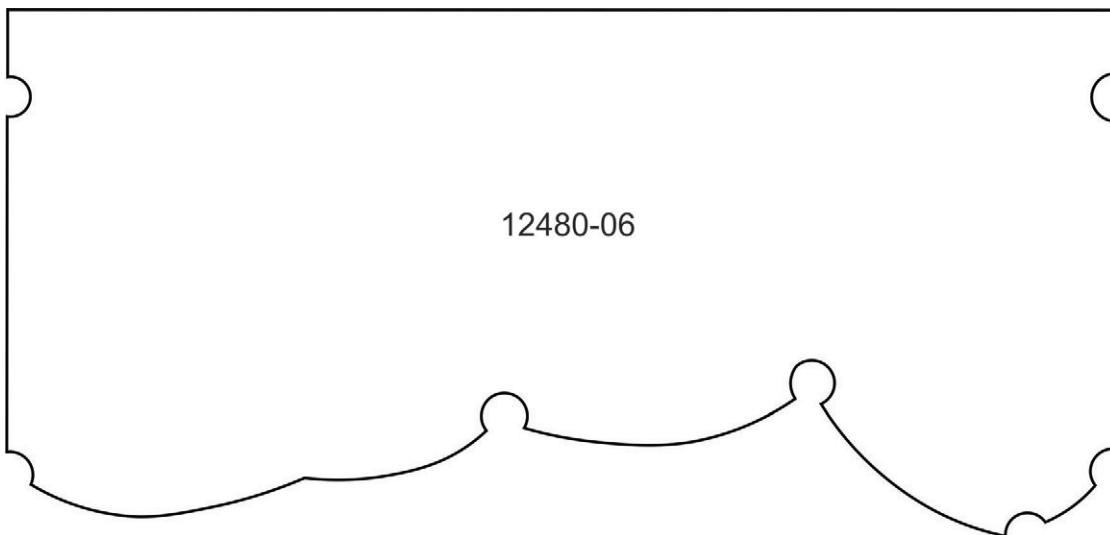
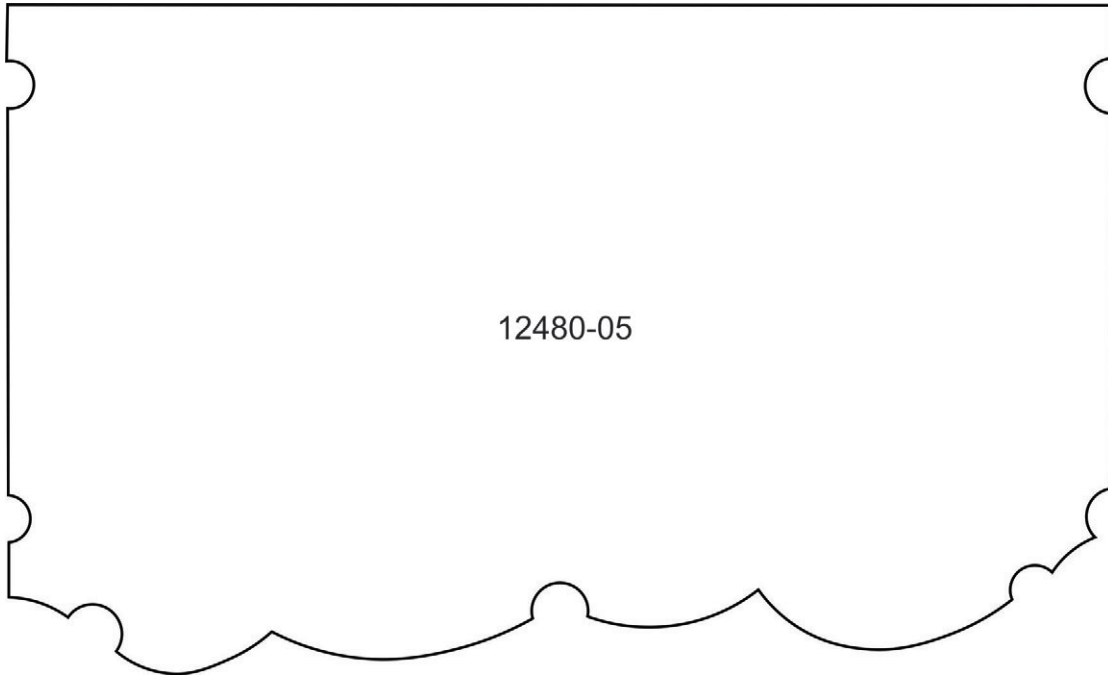

MIRRORED PATTERNS

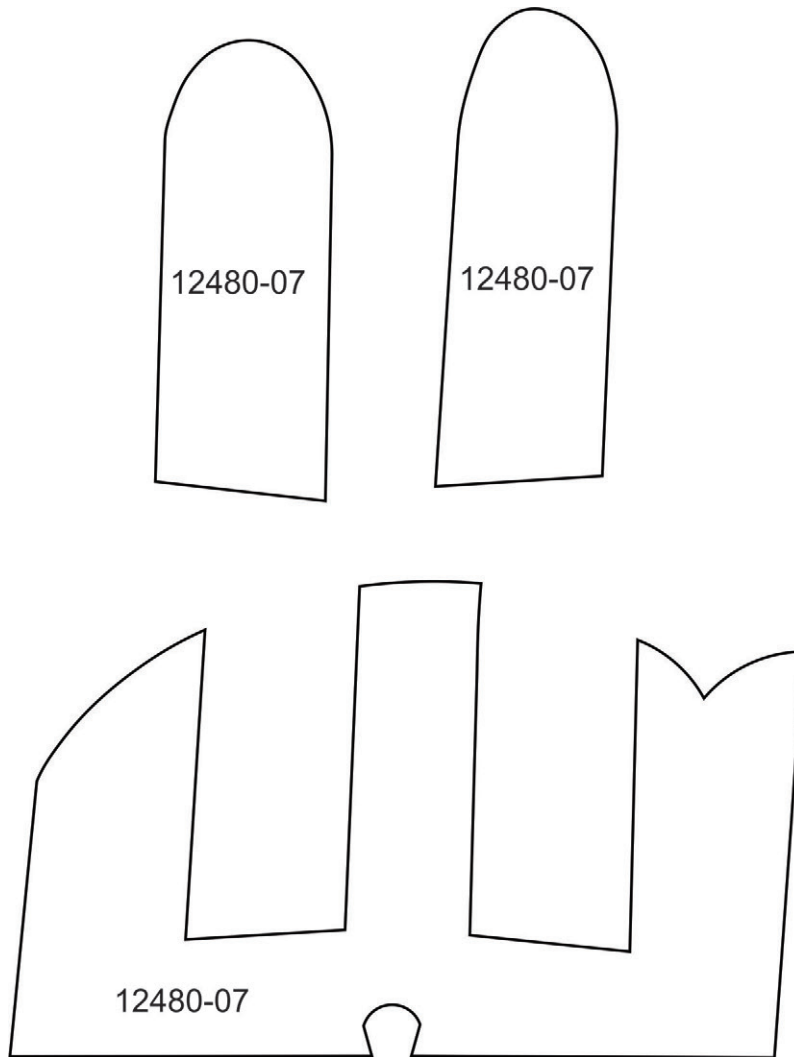

MIRRORED PATTERNS

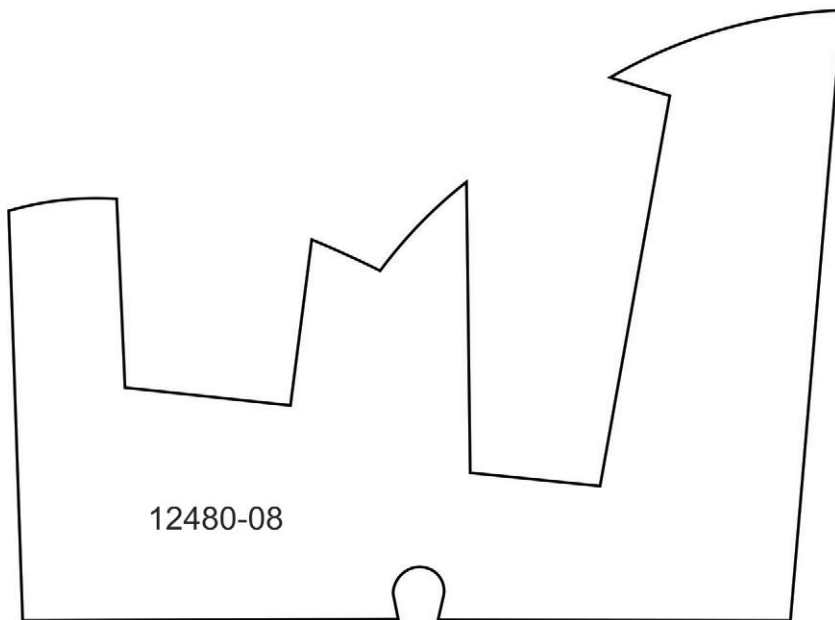
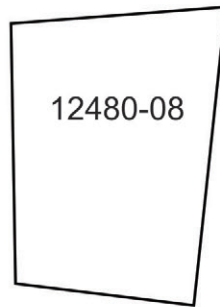
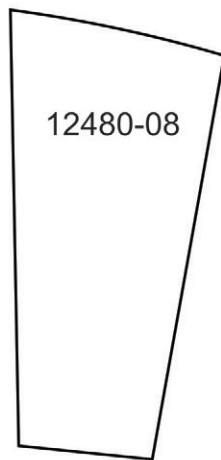

MIRRORED PATTERNS

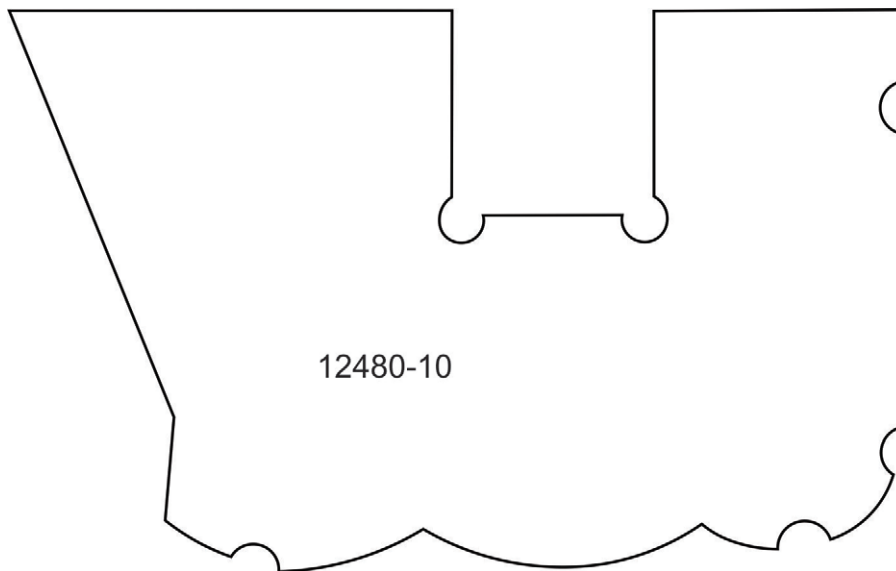
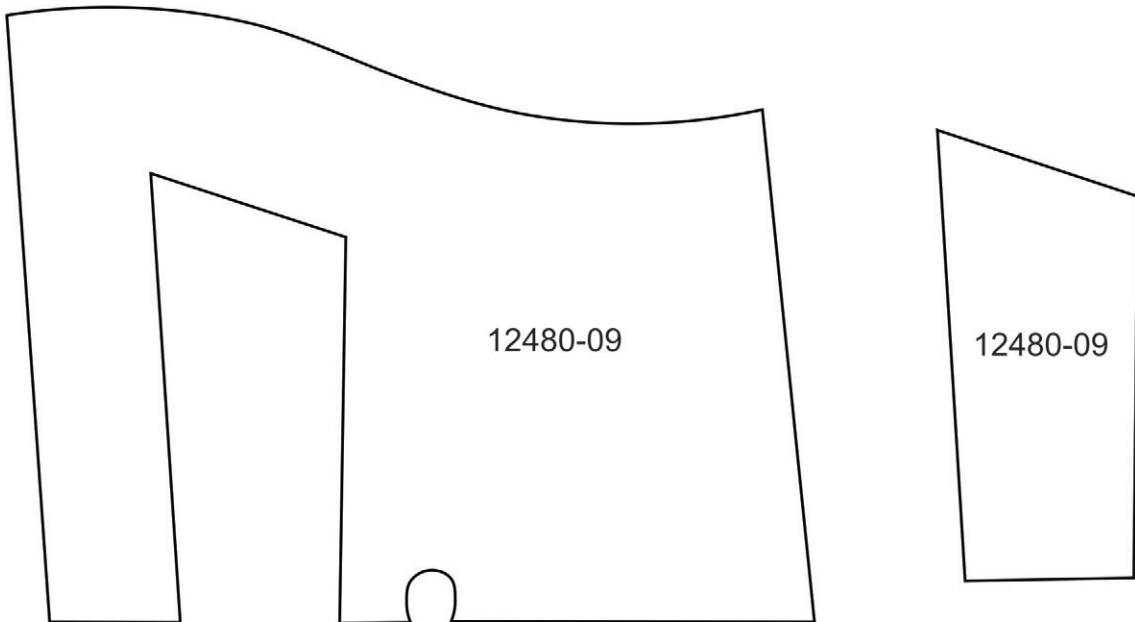

MIRRORED PATTERNS

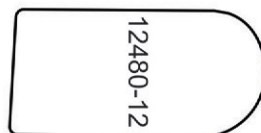
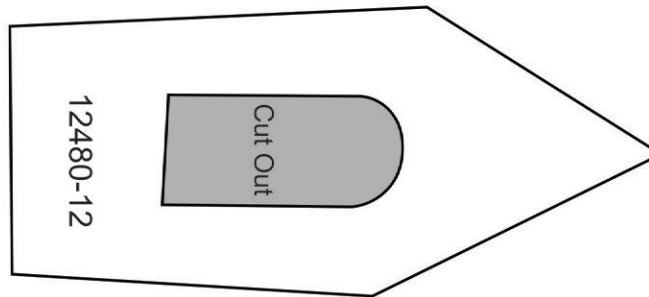
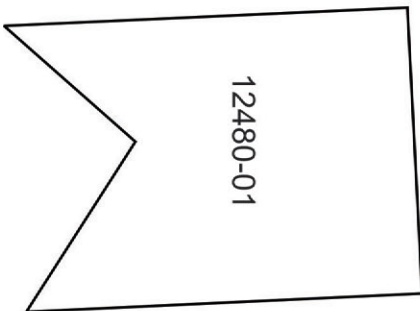
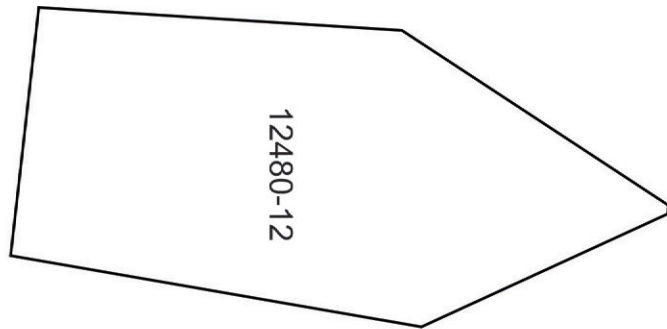
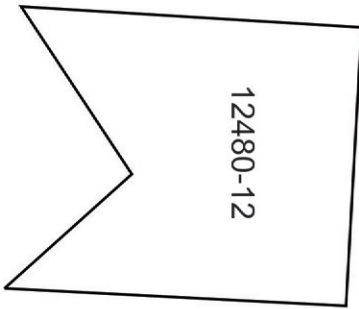
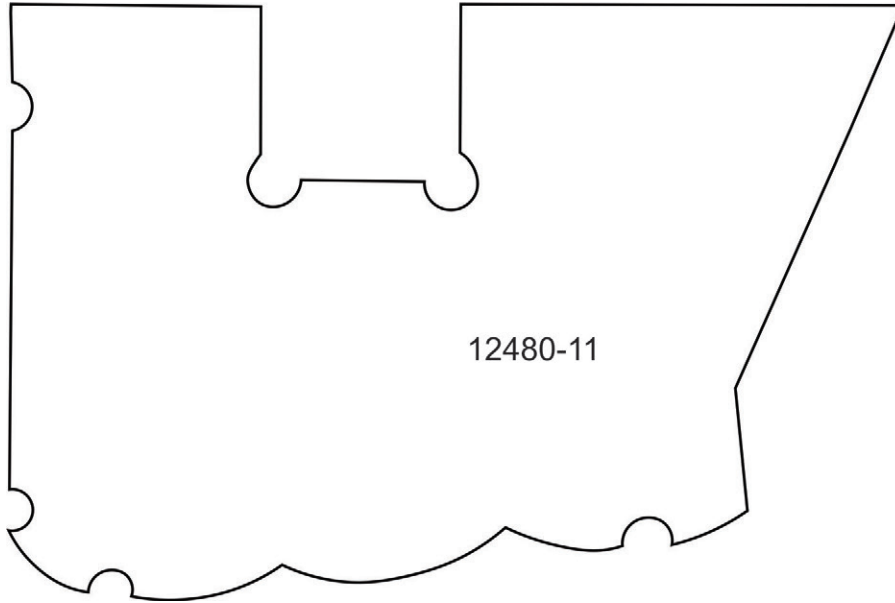

MIRRORED PATTERNS

