

Note: Some designs in this collection may have been created using unique special stitches and/or techniques. To preserve design integrity when rescaling or rotating designs in your software, always rescale or rotate designs using the handles directly on-screen.

This collection includes two types of cover stitches for appliqué designs: Zig-zag stitch and Satin Stitch.

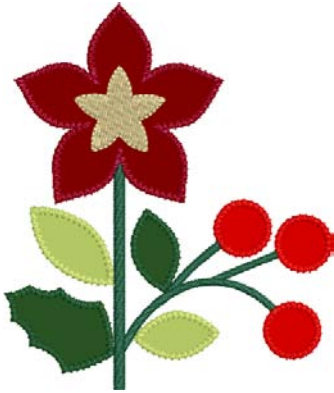

12489-01 Quilt Design 1 ZigZag
4.02 X 4.73 in.
102.11 X 120.14 mm
5,390 St. ⌘



12489-01s Quilt Design 1 Satin
4.12 X 4.78 in.
104.65 X 121.41 mm
10,270 St. ⚡



12489-02 Quilt Design 2 ZigZag
4.43 X 6.80 in.
112.52 X 172.72 mm
1,451 St. ⌘ ⚡ L



12489-02s Quilt Design 2 Satin
4.49 X 6.86 in.
114.05 X 174.24 mm
6,961 St. ⚡ L

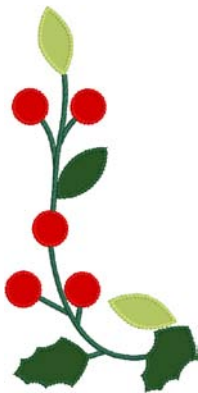

12489-03 Quilt Design 3 ZigZag
3.82 X 7.68 in.
97.03 X 195.07 mm
5,226 St. ⌘ ⚡ L

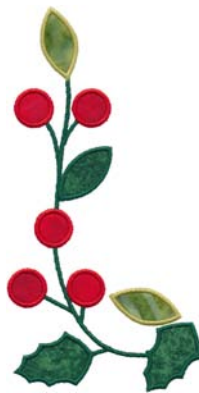

12489-03s Quilt Design 3 Satin
3.90 X 7.78 in.
99.06 X 197.61 mm
10,235 St. ⚡ L



12489-04 Quilt Design 4 ZigZag
3.06 X 7.63 in.
77.72 X 193.80 mm
6,535 St. ⌘ L



12489-04s Quilt Design 4 Satin
3.18 X 7.72 in.
80.77 X 196.09 mm
12,150 St. ⚡ L



12489-05-A Quilt Design 5
ZigZag
3.13 X 6.91 in.
79.50 X 175.51 mm
2,359 St. ⌘ L



12489-05-B Quilt Design 5
ZigZag
3.13 X 6.91 in.
79.50 X 175.51 mm
2,359 St. ⌘ L



12489-05s-A Quilt Design 5 Satin
3.34 X 7.12 in.
84.84 X 180.85 mm
7,632 St. L



12489-05s-B Quilt Design 5 Satin
3.34 X 7.12 in.
84.84 X 180.85 mm
7,632 St. L

⌘ Design contains a loose fill.

⚡ Some white areas shown are not stitched.

L Design is larger than 5" (127 mm) in either direction.

S Design is smaller than 1.5" (38.1 mm) in either direction.

It is a violation of Copyright law to make and distribute copies of electronic designs or artwork.

Electronic designs are licensed to the original purchaser for use at one location. ©2013 OESD, LLC. All rights reserved.

Note: Some designs in this collection may have been created using unique special stitches and/or techniques. To preserve design integrity when rescaling or rotating designs in your software, always rescale or rotate designs using the handles directly on-screen.



12489-06 Quilt Design 6 ZigZag
4.33 X 7.71 in.
109.98 X 195.83 mm
2,598 St. **⌘ L**



12489-06s Quilt Design 6 Satin
4.56 X 8.23 in.
115.82 X 209.04 mm
9,020 St. **L**



12489-07 Quilt Design 7 ZigZag
5.55 X 5.03 in.
140.97 X 127.76 mm
3,303 St. **⌘ L**



12489-07s Quilt Design 7 Satin
5.67 X 5.07 in.
144.02 X 128.78 mm
7,749 St. **L**



12489-08 Quilt Design 8 ZigZag
4.22 X 8.60 in.
107.19 X 218.44 mm
5,980 St. **⌘ L**



12489-08s Quilt Design 8 Satin
4.70 X 9.05 in.
119.38 X 229.87 mm
15,706 St. **L**

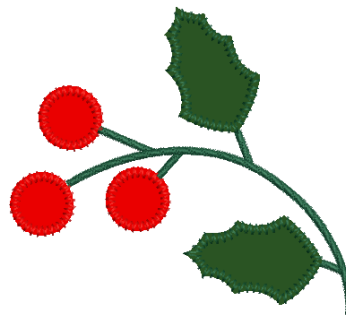

12489-09 Quilt Design 9 ZigZag
3.82 X 3.41 in.
97.03 X 86.61 mm
3,027 St. **⌘**



12489-09s Quilt Design 9 Satin
3.86 X 3.48 in.
98.04 X 88.39 mm
5,706 St.



12489-10 Quilt Design 10 ZigZag
2.62 X 4.78 in.
66.55 X 121.41 mm
2,818 St. **⌘**



12489-10s Quilt Design 10 Satin
2.71 X 4.84 in.
68.83 X 122.94 mm
5,464 St.



12489-11 Quilt Design 11 ZigZag
3.62 X 3.77 in.
91.95 X 95.76 mm
5,591 St. **⌘**

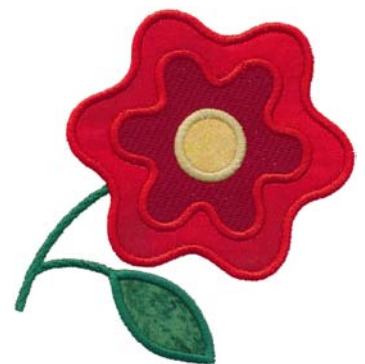

12489-11s Quilt Design 11 Satin
3.65 X 3.83 in.
92.71 X 97.28 mm
8,725 St.

⌘ Design contains a loose fill.

⊗ Some white areas shown are not stitched.

L Design is larger than 5" (127 mm) in either direction.

S Design is smaller than 1.5" (38.1 mm) in either direction.

It is a violation of Copyright law to make and distribute copies of electronic designs or artwork.

Electronic designs are licensed to the original purchaser for use at one location. ©2013 OESD, LLC. All rights reserved.

Note: Some designs in this collection may have been created using unique special stitches and/or techniques. To preserve design integrity when rescaling or rotating designs in your software, always rescale or rotate designs using the handles directly on-screen.



12489-12 Quilt Design 12 ZigZag
3.81 X 3.49 in.
96.77 X 88.65 mm
486 St. **⌘**



12489-12s Quilt Design 12 Satin
3.92 X 3.55 in.
99.57 X 90.17 mm
2,398 St.



12489-13 Quilt Design 13 ZigZag
8.51 X 8.31 in.
216.15 X 211.07 mm
12,973 St. **⌘** **⚠** **L**



12489-13s Quilt Design 13 Satin
8.58 X 8.41 in.
217.93 X 213.61 mm
27,656 St. **⚠** **L**



12489-14 Quilt Design 14 ZigZag
8.64 X 8.65 in.
219.46 X 219.71 mm
20,868 St. **⌘** **L**



12489-14s Quilt Design 14 Satin
8.74 X 8.74 in.
222.00 X 222.00 mm
35,012 St. **L**



12489-15 Quilt Design 15 ZigZag
2.28 X 4.65 in.
57.91 X 118.11 mm
1,741 St. **⌘**



12489-15s Quilt Design 15 Satin
2.44 X 4.74 in.
61.98 X 120.40 mm
4,158 St.

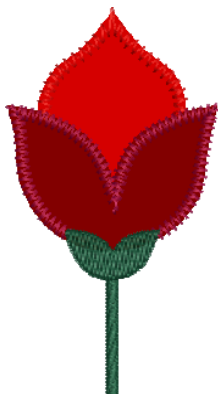

12489-16 Quilt Design 16 ZigZag
1.73 X 3.14 in.
43.94 X 79.76 mm
1,264 St. **⌘**



12489-16s Quilt Design 16 Satin
1.82 X 3.22 in.
46.23 X 81.79 mm
2,484 St.



12489-17-A Quilt Design 17A
ZigZag
2.88 X 8.02 in.
73.15 X 203.71 mm
5,858 St. **⌘** **L**



12489-17-B Quilt Design 17B
ZigZag
2.88 X 8.02 in.
73.15 X 203.71 mm
5,858 St. **⌘** **L**

⌘ Design contains a loose fill.

⚠ Some white areas shown are not stitched.

L Design is larger than 5" (127 mm) in either direction.

S Design is smaller than 1.5" (38.1 mm) in either direction.

Note: Some designs in this collection may have been created using unique special stitches and/or techniques. To preserve design integrity when rescaling or rotating designs in your software, always rescale or rotate designs using the handles directly on-screen.



12489-17s-A Quilt Design 17A Satin
2.98 X 8.12 in.
75.69 X 206.25 mm
11,344 St. **L**



12489-17s-B Quilt Design 17B Satin
2.98 X 8.12 in.
75.69 X 206.25 mm
11,342 St. **L**



12489-18 Quilt Design 18 ZigZag
4.35 X 4.17 in.
110.49 X 105.92 mm
1,008 St. **⌘**



12489-18s Quilt Design 18 Satin
4.48 X 4.31 in.
113.79 X 109.47 mm
4,820 St.



12489-19 Quilt Design 19 ZigZag
4.83 X 7.63 in.
122.68 X 193.80 mm
5,784 St. **⌘ L**



12489-19s Quilt Design 19 Satin
4.92 X 7.74 in.
124.97 X 196.60 mm
13,141 St. **L**



12489-20 Quilt Design 20 ZigZag
3.28 X 6.64 in.
83.31 X 168.66 mm
6,626 St. **⌘ L**



12489-20s Quilt Design 20 Satin
3.33 X 6.69 in.
84.58 X 169.93 mm
12,035 St. **L**



12489-21 Quilt Design 21 ZigZag
5.96 X 4.58 in.
151.38 X 116.33 mm
10,867 St. **⌘ L**



12489-21s Quilt Design 21 Satin
5.97 X 4.58 in.
151.64 X 116.33 mm
14,887 St. **L**



12489-22 Quilt Design 22 ZigZag
3.79 X 8.57 in.
96.27 X 217.68 mm
6,211 St. **⌘ L**



12489-22s Quilt Design 22 Satin
3.90 X 8.68 in.
99.06 X 220.47 mm
13,965 St. **L**

⌘ Design contains a loose fill.

⊗ Some white areas shown are not stitched.

L Design is larger than 5" (127 mm) in either direction.

S Design is smaller than 1.5" (38.1 mm) in either direction.

Note: Some designs in this collection may have been created using unique special stitches and/or techniques. To preserve design integrity when rescaling or rotating designs in your software, always rescale or rotate designs using the handles directly on-screen.



12489-23 Quilt Design 23 ZigZag
8.67 X 8.70 in.
220.22 X 220.98 mm
32,200 St. **⌘ L**



12489-23s Quilt Design 23 Satin
8.74 X 8.74 in.
222.00 X 222.00 mm
37,736 St. **L**

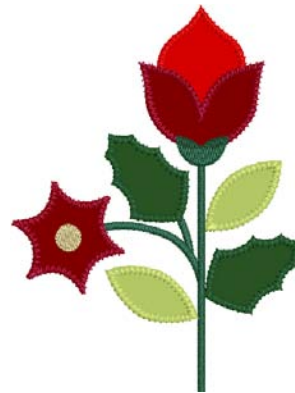

12489-24 Quilt Design 24 ZigZag
3.99 X 5.28 in.
101.35 X 134.11 mm
4,195 St. **⌘ L**



12489-24s Quilt Design 24 Satin
4.10 X 5.33 in.
104.14 X 135.38 mm
8,882 St. **⌘ L**



12489-25 Quilt Design 25 ZigZag
8.26 X 7.86 in.
209.80 X 199.64 mm
20,258 St. **⌘ L**



12489-25s Quilt Design 25 Satin
8.36 X 7.95 in.
212.34 X 201.93 mm
32,721 St. **L**

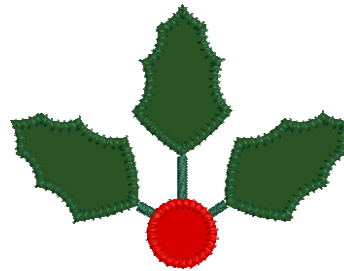

12489-26 Quilt Design 26 ZigZag
3.51 X 2.72 in.
89.15 X 69.09 mm
1,069 St. **⌘**



12489-26s Quilt Design 26 Satin
3.60 X 2.80 in.
91.44 X 71.12 mm
3,437 St.

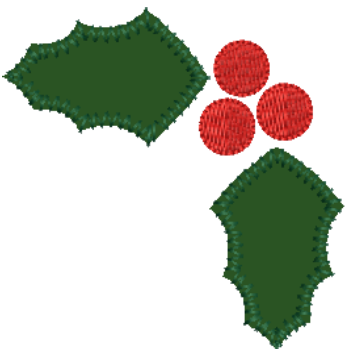

12489-27 Quilt Design 27 ZigZag
2.60 X 2.60 in.
66.04 X 66.04 mm
1,424 St. **⌘**



12489-27s Quilt Design 27 Satin
2.71 X 2.71 in.
68.83 X 68.83 mm
2,842 St.



12489-28 Quilt Design 28 ZigZag
4.74 X 4.72 in.
120.40 X 119.89 mm
1,406 St. **⌘**



12489-28s Quilt Design 28 Satin
4.89 X 4.89 in.
124.21 X 124.21 mm
6,656 St.

⌘ Design contains a loose fill.

⌘ Some white areas shown are not stitched.

L Design is larger than 5" (127 mm) in either direction.

S Design is smaller than 1.5" (38.1 mm) in either direction.

It is a violation of Copyright law to make and distribute copies of electronic designs or artwork.

Electronic designs are licensed to the original purchaser for use at one location. ©2013 OESD, LLC. All rights reserved.

Note: Some designs in this collection may have been created using unique special stitches and/or techniques. To preserve design integrity when rescaling or rotating designs in your software, always rescale or rotate designs using the handles directly on-screen.



12489-29 Quilt Design 29 ZigZag
2.58 X 2.46 in.
65.53 X 62.48 mm
1,659 St. ⚡



12489-29s Quilt Design 29 Satin
2.68 X 2.55 in.
68.07 X 64.77 mm
3,290 St.

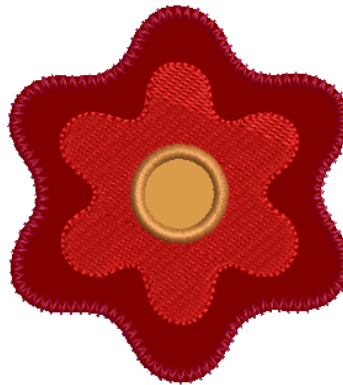

12489-30 Quilt Design 30 ZigZag
2.76 X 3.06 in.
70.10 X 77.72 mm
4,289 St. ⚡



12489-30s Quilt Design 30 Satin
2.82 X 3.11 in.
71.63 X 78.99 mm
6,917 St.



12489-31 Quilt Design 31 ZigZag
2.34 X 2.33 in.
59.44 X 59.18 mm
3,175 St. ⚡



12489-31s Quilt Design 31 Satin
2.42 X 2.43 in.
61.47 X 61.72 mm
4,479 St.



12489-32 Quilt Design 32 ZigZag
1.41 X 1.61 in.
35.81 X 40.89 mm
541 St. ⚡ S



12489-32s Quilt Design 32 Satin
1.50 X 1.66 in.
38.10 X 42.16 mm
1,521 St.



12489-33 Quilt Design 33
Linework
2.57 X 8.22 in.
65.28 X 208.79 mm
5,402 St. ⚡ L

⚡ Design contains a loose fill.

⚡ Some white areas shown are not stitched.

L Design is larger than 5" (127 mm) in either direction.

S Design is smaller than 1.5" (38.1 mm) in either direction.

It is a violation of Copyright law to make and distribute copies of electronic designs or artwork.

Electronic designs are licensed to the original purchaser for use at one location. ©2013 OESD, LLC. All rights reserved.



Christmas Baltimore Album

#12489 / 69 Designs

Listings below indicate color sample, stitching order and suggested thread color number. "I" refers to Isacord thread and "T" refers to Timeless thread. Colors beginning with 20501 refer to YLI Fine Metallics, 7 refer to Yenmet Metallic, 8 refer to YLI Variations Variegated Thread and 9 refer to Isacord Multicolor Variegated.

12489-01 Quilt Design 1 ZigZag		I	T
1. Stems	5324	18202	
2. Light Green Leaves Placement Stitch	0352	18106	
3. Light Green Leaves Tackdown	0352	18106	
4. Dark Green Leaves Placement Stitch	5324	18202	
5. Dark Green Leaves Tackdown	5324	18202	
6. Berries Placement Stitch	1800	12109	
7. Berries Tackdown	1800	12109	
8. Flower Placement Stitch	1912	12133	
9. Flower Tackdown	1912	12133	
10. Light Yellow Petals	0532	20139	

12489-01s Quilt Design 1 Satin		I	T
1. Stems	5324	18202	
2. Light Green Leaves Placement Stitch	0352	18106	
3. Light Green Leaves Cut Line & Tackdown	0352	18106	
4. Light Green Leaves Cover Stitch	0352	18106	
5. Dark Green Leaves Placement Stitch	5324	18202	
6. Dark Green Leaves Cut Line & Tackdown	5324	18202	
7. Dark Green Leaves Cover Stitch	5324	18202	
8. Berries Placement Stitch	1800	12109	
9. Berries Cut Line & Tackdown	1800	12109	
10. Berries Cover Stitch	1800	12109	
11. Flower Placement Stitch	1912	12133	
12. Flower Cut Line & Tackdown	1912	12133	
13. Flower Cover Stitch	1912	12133	
14. Light Yellow Petals	0532	20139	

12489-02 Quilt Design 2 ZigZag		I	T
1. Placement Stitch	0824	22148	
2. Tackdown	0824	22148	

12489-02s Quilt Design 2 Satin		I	T
1. Placement Stitch	0824	22148	
2. Cut Line & Tackdown	0824	22148	
3. Cover Stitch	0824	22148	

12489-03 Quilt Design 3 ZigZag		I	T
1. Stem	5324	18202	
2. Berries Placement Stitch	1800	12109	
3. Berries Tackdown	1800	12109	
4. Dark Green Leaves Placement Stitch	5324	18202	
5. Dark Green Leaves Tackdown	5324	18202	
6. Light Green Leaves Placement Stitch	0352	18106	
7. Light Green Leaves Tackdown	0352	18106	

12489-03s Quilt Design 3 Satin		I	T
1. Stem	5324	18202	
2. Berries Placement Stitch	1800	12109	
3. Berries Cut Line & Tackdown	1800	12109	
4. Berries Cover Stitch	1800	12109	
5. Dark Green Leaves Placement Stitch	5324	18202	
6. Dark Green Leaves Cut Line & Tackdown	5324	18202	
7. Dark Green Leaves Cover Stitch	5324	18202	
8. Light Green Leaves Placement Stitch	0352	18106	
9. Light Green Leaves Cut Line & Tackdown	0352	18106	
10. Light Green Leaves Cover Stitch	0352	18106	

12489-04 Quilt Design 4 ZigZag		I	T
1. Stem	5324	18202	
2. Flower Placement Stitch	1912	12133	
3. Flower Tackdown	1912	12133	
4. Red Petals	1800	12109	
5. Light Yellow Stamen	0532	20139	
6. Dark Green Leaves Placement Stitch	5324	18202	
7. Dark Green Leaves Tackdown	5324	18202	
8. Light Green Leaves Placement Stitch	0352	18106	
9. Light Green Leaves Tackdown	0352	18106	
10. Berries Placement Stitch	1800	12109	
11. Berries Tackdown	1800	12109	

12489-04s Quilt Design 4 Satin		I	T
1. Stem	5324	18202	
2. Flower Placement Stitch	1912	12133	
3. Flower Cut Line & Tackdown	1912	12133	
4. Flower Cover Stitch	1912	12133	
5. Red Petals	1800	12109	
6. Light Yellow Stamen	0532	20139	
7. Dark Green Leaves Placement Stitch	5324	18202	
8. Dark Green Leaves Cut Line & Tackdown	5324	18202	
9. Dark Green Leaves Cover Stitch	5324	18202	
10. Light Green Leaves Placement Stitch	0352	18106	
11. Light Green Leaves Cut Line & Tackdown	0352	18106	
12. Light Green Leaves Cover Stitch	0352	18106	
13. Berries Placement Stitch	1800	12109	
14. Berries Cut Line & Tackdown	1800	12109	
15. Berries Cover Stitch	1800	12109	

12489-05-A Quilt Design 5 ZigZag		I	T
1. Stem	5324	18202	
2. Berries Placement Stitch	1800	12109	
3. Berries Tackdown	1800	12109	
4. Light Green Leaves Placement Stitch	0352	18106	
5. Light Green Leaves Tackdown	0352	18106	
6. Dark Green Leaves Placement Stitch	5324	18202	
7. Dark Green Leaves Tackdown	5324	18202	

12489-05-B Quilt Design 5 ZigZag		I	T
1. Stem	5324	18202	
2. Berries Placement Stitch	1800	12109	
3. Berries Tackdown	1800	12109	
4. Light Green Leaves Placement Stitch	0352	18106	
5. Light Green Leaves Tackdown	0352	18106	
6. Dark Green Leaves Placement Stitch	5324	18202	
7. Dark Green Leaves Tackdown	5324	18202	

12489-05s-A Quilt Design 5 Satin		I	T
1. Stem	5324	18202	
2. Berries Placement Stitch	1800	12109	
3. Berries Cut Line & Tackdown	1800	12109	
4. Berries Cover Stitch	1800	12109	
5. Light Green Leaves Placement Stitch	0352	18106	
6. Light Green Leaves Cut Line & Tackdown	0352	18106	
7. Light Green Leaves Cover Stitch	0352	18106	
8. Dark Green Leaves Placement Stitch	5324	18202	
9. Light Green Leaves Cut Line & Tackdown	5324	18202	
10. Dark Green Leaves Cover Stitch	5324	18202	

12489-05s-B Quilt Design 5 Satin		I	T
1. Stem	5324	18202	
2. Berries Placement Stitch	1800	12109	
3. Berries Cut Line & Tackdown	1800	12109	
4. Berries Cover Stitch	1800	12109	
5. Light Green Leaves Placement Stitch	0352	18106	
6. Light Green Leaves Cut Line & Tackdown	0352	18106	
7. Light Green Leaves Cover Stitch	0352	18106	
8. Dark Green Leaves Placement Stitch	5324	18202	
9. Dark Green Leaves Cut Line & Tackdown	5324	18202	
10. Dark Green Leaves Cover Stitch	5324	18202	

12489-06 Quilt Design 6 ZigZag		I	T
1. Tree Placement Stitch	5324	18202	
2. Tree Tackdown	5324	18202	
3. Dark Yellow Star Placement Stitch	0824	22148	
4. Dark Yellow Star Tackdown	0824	22148	
5. Tree Trunk	0933	26148	

12489-06s Quilt Design 6 Satin		I	T
1. Tree Placement Stitch	5324	18202	
2. Tree Cut Line & Tackdown	5324	18202	
3. Tree Cover Stitch	5324	18202	
4. Star Placement Stitch	0824	22148	
5. Star Cut Line & Tackdown	0824	22148	
6. Star Cover Stitch	0824	22148	
7. Tree Trunk	0933	26148	

12489-07 Quilt Design 7 ZigZag		I	T
1. Antlers	0824	22148	
2. Deer Placement Stitch	0747	18185	
3. Deer Tackdown	0747	18185	

12489-07s Quilt Design 7 Satin		I	T
1. Antlers	0824	22148	
2. Deer Placement Stitch	0747	18185	
3. Deer Cut Line & Tackdown	0747	18185	
4. Deer Cover Stitch	0747	18185	

12489-08 Quilt Design 8 ZigZag		I	T
1. Light Green Leaves Placement Stitch	0352	18106	
2. Light Green Leaves Tackdown	0352	18106	
3. Dark Green Leaves Placement Stitch	5324	18202	
4. Dark Green Leaves Tackdown	5324	18202	
5. Berries & Flower Placement Stitch	1800	12109	
6. Berries & Flower Tackdown	1800	12109	
7. Dark Red Flowers Placement Stitch	1912	12133	
8. Dark Red Flowers Tackdown	1912	12133	
9. Red Petals	1800	12109	
10. Light Yellow Stamen Placement Stitch	0532	20139	
11. Dark Yellow Stamen Tackdown	0824	22148	

12489-08s Quilt Design 8 Satin		I	T
1. Light Green Leaves Placement Stitch	0352	18106	
2. Light Green Leaves Cut Line & Tackdown	0352	18106	
3. Light Green Leaves Cover Stitch	0352	18106	
4. Dark Green Leaves Placement Stitch	5324	18202	
5. Dark Green Leaves Cut Line & Tackdown	5324	18202	
6. Dark Green Leaves Cover Stitch	5324	18202	
7. Red Berries & Flower Placement Stitch	1800	12109	
8. Red Berries & Flower Cut Line & Tackdown	1800	12109	
9. Red Berries & Flower Cover Stitch	1800	12109	
10. Dark Red Flowers Placement Stitch	1912	12133	
11. Dark Red Flowers Cut Line & Tackdown	1912	12133	
12. Dark Red Flowers Cover Stitch	1912	12133	
13. Red Petals	1800	12109	
14. Light Yellow Stamen	0532	20139	
15. Dark Yellow Stamen	0824	22148	

12489-09 Quilt Design 9 ZigZag		I	T
1. Stems	5324	18202	
2. Dark Green Leaves Placement Stitch	5324	18202	
3. Dark Green Leaves Tackdown	5324	18202	
4. Berries Placement	1800	12109	
5. Berries Tackdown	1800	12109	

12489-09s Quilt Design 9 Satin		I	T
1. Stems	5324	18202	
2. Dark Green Leaves Placement Stitch	5324	18202	
3. Dark Green Leaves Cut Line & Tackdown	5324	18202	
4. Dark Green Leaves Cover Stitch	5324	18202	
5. Berries Placement Stitch	1800	12109	
6. Berries Cut Line & Tackdown	1800	12109	
7. Berries Cover Stitch	1800	12109	



Christmas Baltimore Album

#12489 / 69 Designs

Listings below indicate color sample, stitching order and suggested thread color number. "I" refers to Isacord thread and "T" refers to Timeless thread. Colors beginning with 20501 refer to YLI Fine Metallics, 7 refer to Yenmet Metallic, 8 refer to YLI Variations Variegated Thread and 9 refer to Isacord Multicolor Variegated.

12489-10 Quilt Design 10 ZigZag		I	T
1. Stem	5324	18202	
2. Light Green Leaves Placement Stitch	0352	18106	
3. Light Green Leaves Tackdown	0352	18106	
4. Dark Red Flower Placement Stitch	1912	12133	
5. Dark Red Flower Tackdown	1912	12133	
6. Light Yellow Stamen	0532	20139	

12489-10s Quilt Design 10 Satin		I	T
1. Stem	5324	18202	
2. Light Green Leaves Placement Stitch	0352	18106	
3. Light Green Leaves Cut Line & Tackdown	0352	18106	
4. Light Green Leaves Cover Stitch	0352	18106	
5. Flower Placement Stitch	1912	12133	
6. Flower Cut Line & Tackdown	1912	12133	
7. Flower Cover Stitch	1912	12133	
8. Light Yellow Stamen	0532	20139	

12489-11 Quilt Design 11 ZigZag		I	T
1. Stem	5324	18202	
2. Dark Green Leaf Placement Stitch	5324	18202	
3. Dark Green Leaf Tackdown	5324	18202	
4. Red Flower Placement Stitch	1800	12109	
5. Dark Red Inner Flower	1912	12133	
6. Red Flower Tackdown	1800	12109	
7. Light Yellow Stamen Placement Stitch	0532	20139	
8. Light Yellow Stamen Tackdown	0532	20139	

12489-11s Quilt Design 11 Satin		I	T
1. Stem	5324	18202	
2. Dark Green Leaf Placement Stitch	5324	18202	
3. Dark Green Leaf Cut Line & Tackdown	5324	18202	
4. Dark Green Leaf Cover Stitch	5324	18202	
5. Red Flower Placement Stitch	1800	12109	
6. Red Flower Cut Line & Tackdown	1800	12109	
7. Dark Red Inner Flower	1912	12133	
8. Red Flower Cover Stitch	1800	12109	
9. Stamen Placement Stitch	0532	20139	
10. Stamen Cut Line & Tackdown	0532	20139	
11. Stamen Cover Stitch	0532	20139	

12489-12 Quilt Design 12 ZigZag		I	T
1. Vase Placement Stitch	0747	18185	
2. Vase Tackdown	0747	18185	

12489-12s Quilt Design 12 Satin		I	T
1. Vase Placement Stitch	0747	18185	
2. Vase Cut Line & Tackdown	0747	18185	
3. Vase Cover Stitch	0747	18185	

12489-13 Quilt Design 13 ZigZag		I	T
1. Stems	5324	18202	
2. Dark Green Leaves Placement Stitch	5324	18202	
3. Dark Green Leaves Tackdown	5324	18202	
4. Berries Placement Stitch	1800	12109	
5. Berries Tackdown	1800	12109	
6. Light Green Leaves Placement Stitch	0352	18106	
7. Light Green Leaves Tackdown	0352	18106	

12489-13s Quilt Design 13 Satin		I	T
1. Stems	5324	18202	
2. Dark Green Leaves Placement Stitch	5324	18202	
3. Dark Green Leaves Cut Line & Tackdown	5324	18202	
4. Dark Green Leaves Cover Stitch	5324	18202	
5. Berries Placement Stitch	1800	12109	
6. Berries Cut Line & Tackdown	1800	12109	
7. Berries Cover Stitch	1800	12109	
8. Light Green Leaves Placement Stitch	0352	18106	
9. Light Green Leaves Cut Line & Tackdown	0352	18106	
10. Light Green Leaves Cover Stitch	0352	18106	

12489-14 Quilt Design 14 ZigZag		I	T
1. Coat Placement Stitch	1800	12109	
2. Coat Tackdown	1800	12109	
3. Bag Placement Stitch	0747	18185	
4. Bag Tackdown	0747	18185	
5. Dark Red Belt & Pants	1912	12133	
6. Dark Green Leaves Placement Stitch	5324	18202	
7. Dark Green Leaves Tackdown & Details	5324	18202	
8. Buckle	0824	22148	
9. Hat & Arm Placement Stitch	1800	12109	
10. Hat & Arm Tackdown & Berries	1800	12109	
11. Off White Beard & Fringe Placement Stitch	0660	20157	
12. Off White Beard & Fringe Tackdown	0660	20157	
13. Face	1760	20124	

12489-14s Quilt Design 14 Satin		I	T
1. Coat Placement Stitch	1800	12109	
2. Coat Cut Line & Tackdown	1800	12109	
3. Coat Cover Stitch	1800	12109	
4. Bag Placement Stitch	0747	18185	
5. Bag Cut Line & Tackdown	0747	18185	
6. Bag Cover Stitch	0747	18185	
7. Dark Red Belt & Pants	1912	12133	
8. Dark Green Leaves Placement Stitch	5324	18202	
9. Dark Green Leaves Cut Line & Tackdown	5324	18202	
10. Dark Green Leaves Cover Stitch & Details	5324	18202	
11. Buckle	0824	22148	
12. Hat & Arm Placement Stitch	1800	12109	
13. Hat & Arm Cut Line & Tackdown & Berries	1800	12109	
14. Hat & Arm Cover Stitch & Berries	1800	12109	
15. Off White Beard & Fringe Placement Stitch	0660	20157	
16. Off White Beard & Fringe Cut Line & Tackdown	0660	20157	
17. Off White Beard & Fringe Cover Stitch	0660	20157	
18. Face	1760	20124	

12489-15 Quilt Design 15 ZigZag		I	T
1. Stem	5324	18202	
2. Light Green Leaves Placement Stitch	0352	18106	
3. Light Green Leaves Tackdown	0352	18106	
4. Star Placement Stitch	0824	22148	
5. Star Tackdown	0824	22148	

12489-15s Quilt Design 15 Satin		I	T
1. Stem	5324	18202	
2. Light Green Leaves Placement Stitch	0352	18106	
3. Light Green Leaves Cut Line & Tackdown	0352	18106	
4. Light Green Leaves Cover Stitch	0352	18106	
5. Star Placement Stitch	0824	22148	
6. Star Cut Line & Tackdown	0824	22148	
7. Star Cover Stitch	0824	22148	

12489-16 Quilt Design 16 ZigZag		I	T
1. Red Flower Placement Stitch	1800	12109	
2. Red Flower Tackdown	1800	12109	
3. Dark Red Flower Placement Stitch	1912	12133	
4. Dark Red Flower Tackdown	1912	12133	
5. Stem	5324	18202	

12489-16s Quilt Design 16 Satin		I	T
1. Red Flower Placement Stitch	1800	12109	
2. Red Flower Cut Line & Tackdown	1800	12109	
3. Red Flower Cover Stitch	1800	12109	
4. Dark Red Flower Placement Stitch	1912	12133	
5. Dark Red Flower Cut Line & Tackdown	1912	12133	
6. Dark Red Flower Cover Stitch	1912	12133	
7. Stem	5324	18202	

12489-17-A Quilt Design 17A ZigZag		I	T
1. Stem	5324	18202	
2. Red Berries & Flowers Placement Stitch	1800	12109	
3. Red Berries & Flowers Tackdown	1800	12109	
4. Dark Red Flower Placement Stitch	1912	12133	
5. Dark Red Flower Tackdown	1912	12133	
6. Dark Green Leaves Placement Stitch	5324	18202	
7. Dark Green Leaves Tackdown & Details	5324	18202	
8. Light Green Leaves Placement Stitch	0352	18106	
9. Light Green Leaves Tackdown	0352	18106	
10. Light Yellow Stamen	0532	20139	

12489-17-B Quilt Design 17B ZigZag		I	T
1. Stem	5324	18202	
2. Red Berries & Flowers Placement Stitch	1800	12109	
3. Red Berries & Flowers Tackdown	1800	12109	
4. Dark Red Flower Placement Stitch	1912	12133	
5. Dark Red Flower Tackdown	1912	12133	
6. Dark Green Leaves Placement Stitch	5324	18202	
7. Dark Green Leaves Tackdown & Details	5324	18202	
8. Light Green Leaves Placement Stitch	0352	18106	
9. Light Green Leaves Tackdown	0352	18106	
10. Light Yellow Stamen	0532	20139	

12489-17s-A Quilt Design 17A Satin		I	T
1. Stem	5324	18202	
2. Red Berries & Flowers Placement Stitch	1800	12109	
3. Red Berries & Flowers Cut Line & Tackdown	1800	12109	
4. Red Berries & Flowers Cover Stitch	1800	12109	
5. Dark Red Flower Placement Stitch	1912	12133	
6. Dark Red Flower Cut Line & Tackdown	1912	12133	
7. Dark Red Flower Cover Stitch	1912	12133	
8. Dark Green Leaves Placement Stitch	5324	18202	
9. Dark Green Leaves Cut Line & Tackdown	5324	18202	
10. Dark Green Leaves Cover Stitch & Details	5324	18202	
11. Light Green Leaves Placement Stitch	0352	18106	
12. Light Green Leaves Cut Line & Tackdown	0352	18106	
13. Light Green Leaves Cover Stitch	0352	18106	
14. Light Yellow Stamen	0532	20139	

12489-17s-B Quilt Design 17B Satin		I	T
1. Stem	5324	18202	
2. Red Berries & Flowers Placement Stitch	1800	12109	
3. Red Berries & Flowers Cut Line & Tackdown	1800	12109	
4. Red Berries & Flowers Cover Stitch	1800	12109	
5. Dark Red Flower Placement Stitch	1912	12133	
6. Dark Red Flower Cut Line & Tackdown	1912	12133	
7. Dark Red Flower Cover Stitch	1912	12133	
8. Dark Green Leaves Placement Stitch	5324	18202	
9. Dark Green Leaves Cut Line & Tackdown	5324	18202	
10. Dark Green Leaves Cover Stitch & Details	5324	18202	
11. Light Green Leaves Placement Stitch	0352	18106	
12. Light Green Leaves Cut Line & Tackdown	0352	18106	
13. Light Green Leaves Cover Stitch	0352	18106	
14. Light Yellow Stamen	0532	20139	

12489-18 Quilt Design 18 ZigZag		I	T
1. Light Yellow Star Placement Stitch	0532	20139	
2. Light Yellow Star Tackdown	0532	20139	
3. Dark Yellow Star Placement Stitch	0824	22148	
4. Dark Yellow Star Tackdown	0824	22148	

12489-18s Quilt Design 18 Satin		I	T
1. Light Yellow Star Placement Stitch	0532	20139	
2. Light Yellow Star Cut Line & Tackdown	0532	20139	
3. Light Yellow Star Cover Stitch	0532	20139	
4. Dark Yellow Star Placement Stitch	0824	22148	
5. Dark Yellow Star Cut Line & Tackdown	0824	22148	
6. Dark Yellow Star Cover Stitch	0824	22148	



Christmas Baltimore Album

#12489 / 69 Designs

Listings below indicate color sample, stitching order and suggested thread color number. "I" refers to Isacord thread and "T" refers to Timeless thread. Colors beginning with 20501 refer to YLI Fine Metallics, 7 refer to Yenmet Metallic, 8 refer to YLI Variations Variegated Thread and 9 refer to Isacord Multicolor Variegated.

12489-19 Quilt Design 19 ZigZag

	I	T
1. Stocking Placement Stitch.....	1800	12109
2. Stocking Tackdown.....	1800	12109
3. Off White Candy Cane.....	0660	20157
4. Off White Upper Stocking Placement Stitch.....	0660	20157
5. Off White Upper Stocking Tackdown.....	0660	20157
6. Red Candy Cane.....	1800	12109
7. Berry Placement Stitch.....	1800	12109
8. Berry Tackdown.....	1800	12109
9. Toe & Heel Placement Stitch.....	1912	12133
10. Toe & Heel Tackdown.....	1912	12133
11. Light Green Leaves Placement Stitch.....	0352	18106
12. Light Green Leaves Tackdown.....	0352	18106
13. Dark Green Leaves Placement Stitch.....	5324	18202
14. Dark Green Leaves Tackdown.....	5324	18202

12489-19s Quilt Design 19 Satin

1. Stocking Placement Stitch.....	1800	12109
2. Stocking Cut Line & Tackdown.....	1800	12109
3. Stocking Cover Stitch.....	1800	12109
4. Off White Candy Cane.....	0660	20157
5. Off White Upper Stocking Placement Stitch.....	0660	20157
6. Off White Upper Stocking Cut Line & Tackdown.....	0660	20157
7. Off White Upper Stocking Cover Stitch.....	0660	20157
8. Red Candy Cane.....	1800	12109
9. Berry Placement Stitch.....	1800	12109
10. Berry Cut Line & Tackdown.....	1800	12109
11. Berry Cover Stitch.....	1800	12109
12. Toe & Heel Placement Stitch.....	1912	12133
13. Toe & Heel Cut Line & Tackdown.....	1912	12133
14. Toe & Heel Cover Stitch.....	1912	12133
15. Light Green Leaves Placement Stitch.....	0352	18106
16. Light Green Leaves Cut Line & Tackdown.....	0352	18106
17. Light Green Leaves Cover Stitch.....	0352	18106
18. Dark Green Leaves Placement Stitch.....	5324	18202
19. Dark Green Leaves Cut Line & Tackdown.....	5324	18202
20. Dark Green Leaves Cover Stitch.....	5324	18202

12489-20 Quilt Design 20 ZigZag

1. Stem.....	5324	18202
2. Dark Green Leaves Placement Stitch.....	5324	18202
3. Dark Green Leaves Tackdown.....	5324	18202
4. Light Green Leaves Placement Stitch.....	0352	18106
5. Light Green Leaves Tackdown.....	0352	18106
6. Dark Red Flower Placement Stitch.....	1912	12133
7. Dark Red Flower Tackdown.....	1912	12133
8. Red Inner Flower.....	1800	12109
9. Light Yellow Stamen Placement Stitch.....	0532	20139
10. Light Yellow Stamen Tackdown.....	0532	20139

12489-20s Quilt Design 20 Satin

1. Stem.....	5324	18202
2. Dark Green Leaves Placement Stitch.....	5324	18202
3. Dark Green Leaves Cut Line & Tackdown.....	5324	18202
4. Dark Green Leaves Cover Stitch.....	5324	18202
5. Light Green Leaves Placement Stitch.....	0352	18106
6. Light Green Leaves Cut Line & Tackdown.....	0352	18106
7. Light Green Leaves Cover Stitch.....	0352	18106
8. Light Red Flower Placement Stitch.....	1800	12109
9. Light Red Flower Cut Line & Tackdown.....	1800	12109
10. Dark Red Inner Flower.....	1912	12133
11. Light Red Cover Stitch.....	1800	12109
12. Light Yellow Stamen Placement Stitch.....	0532	20139
13. Light Yellow Stamen Cut Line & Tackdown.....	0532	20139
14. Light Yellow Stamen Cover Stitch.....	0532	20139

12489-21 Quilt Design 21 ZigZag

1. Top Right Gift Placement Stitch.....	5324	18202
2. Top Right Gift Tackdown.....	5324	18202
3. Top Left Gift Placement Stitch.....	0352	18106
4. Top Left Gift Tackdown.....	0352	18106
5. Bottom Right Gift Placement Stitch.....	5324	18202
6. Bottom Right Gift Tackdown.....	5324	18202
7. Bottom Left Gift Placement Stitch.....	0352	18106
8. Bottom Left Gift Tackdown.....	0352	18106
9. Ribbons.....	1800	12109
10. Sled Rails.....	0824	22148
11. Sled Placement Stitch.....	1912	12133
12. Sled Tackdown.....	1912	12133

12489-21s Quilt Design 21 Satin

1. Top Right Gift Placement Stitch.....	5324	18202
2. Top Right Gift Cut Line & Tackdown.....	5324	18202
3. Top Right Gift Cover Stitch.....	5324	18202
4. Top Left Gift Placement Stitch.....	0352	18106
5. Top Left Gift Cut Line & Tackdown.....	0352	18106
6. Top Left Gift Cover Stitch.....	0352	18106
7. Bottom Right Gift Placement Stitch.....	5324	18202
8. Bottom Right Gift Cut Line & Tackdown.....	5324	18202
9. Bottom Right Gift Cover Stitch.....	5324	18202
10. Bottom Left Gift Placement Stitch.....	0352	18106
11. Bottom Left Gift Cut Line & Tackdown.....	0352	18106
12. Bottom Left Gift Cover Stitch.....	0352	18106
13. Ribbons.....	1800	12109
14. Sled Rails.....	0824	22148
15. Sled Placement Stitch.....	1912	12133
16. Sled Cut Line & Tackdown.....	1912	12133
17. Sled Cover Stitch.....	1912	12133

12489-22 Quilt Design 22 ZigZag

1. Stem.....	5324	18202
2. Light Green Leaves Placement Stitch.....	0352	18106
3. Light Green Leaves Tackdown.....	0352	18106
4. Red Berries & Flowers Placement Stitch.....	1800	12109
5. Red Berries & Flowers Tackdown.....	1800	12109
6. Dark Red Flower Placement Stitch.....	1912	12133
7. Dark Red Flower Tackdown.....	1912	12133
8. Dark Green Leaves Placement Stitch.....	5324	18202
9. Dark Green Leaves Tackdown & Stem.....	5324	18202
10. Light Yellow Stamen.....	0532	20139

12489-22s Quilt Design 22 Satin

1. Stem.....	5324	18202
2. Light Green Leaves Placement Stitch.....	0352	18106
3. Light Green Leaves Cut Line & Tackdown.....	0352	18106
4. Light Green Leaves Cover Stitch.....	0352	18106
5. Red Berries & Flowers Placement Stitch.....	1800	12109
6. Red Berries & Flowers Cut Line & Tackdown.....	1800	12109
7. Red Berries & Flowers Cover Stitch.....	1800	12109
8. Dark Red Flower Placement Stitch.....	1912	12133
9. Dark Red Flower Cut Line & Tackdown.....	1912	12133
10. Dark Red Flower Cover Stitch.....	1912	12133
11. Dark Green Leaves Placement Stitch.....	5324	18202
12. Dark Green Leaves Cut Line & Tackdown.....	5324	18202
13. Dark Green Leaves Cover Stitch & Details.....	5324	18202
14. Light Yellow Stamens.....	0532	20139

12489-23 Quilt Design 23 ZigZag

1. Off White Candy Cane Stripes.....	0660	20157
2. Red Candy Cane Stripes.....	1800	12109
3. Dark Green Leaves Placement Stitch.....	5324	18202
4. Dark Green Leaves Tackdown.....	5324	18202
5. Berries.....	1800	12109

12489-23s Quilt Design 23 Satin

1. Off White Candy Cane Stripes.....	0660	20157
2. Red Candy Cane Stripes.....	1800	12109
3. Dark Green Leaves Placement Stitch.....	5324	18202
4. Dark Green Leaves Cut Line & Tackdown.....	5324	18202
5. Dark Green Leaves Cover Stitch.....	5324	18202
6. Berries.....	1800	12109

12489-24 Quilt Design 24 ZigZag

1. Stem.....	5324	18202
2. Dark Green Leaves Placement Stitch.....	5324	18202
3. Dark Green Leaves Tackdown.....	5324	18202
4. Light Green Leaves Placement Stitch.....	0352	18106
5. Light Green Leaves Tackdown.....	0352	18106
6. Red Flower Placement Stitch.....	1800	12109
7. Red Flower Tackdown.....	1800	12109
8. Dark Red Flowers Placement Stitch.....	1912	12133
9. Dark Red Flowers Tackdown.....	1912	12133
10. Dark Green Details.....	5324	18202
11. Light Yellow Stamen.....	0532	20139

12489-24s Quilt Design 24 Satin

1. Stem.....	5324	18202
2. Dark Green Leaves Placement Stitch.....	5324	18202
3. Dark Green Leaves Cut Line & Tackdown.....	5324	18202
4. Dark Green Leaves Cover Stitch.....	5324	18202
5. Light Green Leaves Placement Stitch.....	0352	18106
6. Light Green Leaves Cut Line & Tackdown.....	0352	18106
7. Light Green Leaves Cover Stitch.....	0352	18106
8. Red Flower Placement Stitch.....	1800	12109
9. Red Flower Cut Line & Tackdown.....	1800	12109
10. Red Flower Cover Stitch.....	1800	12109
11. Dark Red Flowers Placement Stitch.....	1912	12133
12. Dark Red Flowers Cut Line & Tackdown.....	0020	28151
13. Dark Red Flowers Cover Stitch.....	1912	12133
14. Dark Green Detail.....	5324	18202
15. Light Yellow Stamen.....	0532	20139

12489-25 Quilt Design 25 ZigZag

1. Stems.....	5324	18202
2. Dark Green Leaves Placement Stitch.....	5324	18202
3. Dark Green Leaves Tackdown.....	5324	18202
4. Light Green Leaves Placement Stitch.....	0352	18106
5. Light Green Leaves Tackdown.....	0352	18106
6. Dark Red Flower Placement Stitch.....	1912	12133
7. Dark Red Flower Tackdown.....	1912	12133
8. Light Yellow Flowers Placement Stitch.....	0532	20139
9. Light Yellow Flowers Tackdown.....	0532	20139
10. Dark Yellow Stamens.....	0824	22148
11. Dark Yellow Flowers Placement Stitch.....	0824	22148
12. Dark Yellow Flowers Tackdown.....	0824	22148
13. Brown Petals.....	0747	18185
14. Brown Stamen Placement Stitch.....	0747	18185
15. Brown Stamen Tackdown.....	0747	18185
16. Light Yellow Stamen.....	0532	20139
17. Dark Green Details.....	5324	18202



Christmas Baltimore Album

#12489 / 69 Designs

Listings below indicate color sample, stitching order and suggested thread color number. "I" refers to Isacord thread and "T" refers to Timeless thread. Colors beginning with 20501 refer to YLI Fine Metallics, 7 refer to Yenmet Metallic, 8 refer to YLI Variations Variegated Thread and 9 refer to Isacord Multicolor Variegated.

		I	T			I	T			I	T
12489-25s Quilt Design 25 Satin											
■	1. Stems	5324	18202	■	1. Dark Green Leaves Placement Stitch	5324	18202	■	1. Dark Red Flower Placement Stitch	1912	12133
■	2. Dark Green Leaves Placement Stitch	5324	18202	■	2. Dark Green Leaves Cut Line & Tackdown.....	5324	18202	■	2. Dark Red Flower Cut Line & Tackdown.....	1912	12133
■	3. Dark Green Leaves Cut Line & Tackdown.....	5324	18202	■	3. Dark Green Leaves Cover Stitch.....	5324	18202	■	3. Red Inner Flower	1800	12109
■	4. Dark Green Leaves Cover Stitch.....	5324	18202	■	4. Berries	1800	12109	■	4. Dark Red Flower Cover Stitch.....	1912	12133
■	5. Light Green Leaves Placement Stitch	0352	18106	12489-28 Quilt Design 28 ZigZag				■	5. Stamen Placement Stitch.....	0824	22148
■	6. Light Green Leaves Cut Line & Tackdown ...	0352	18106	■	1. Red Flower Placement Stitch	1800	12109	■	6. Stamen Cut Line & Tackdown	0824	22148
■	7. Light Green Leaves Cover Stitch	0352	18106	■	2. Red Flower Cover Stitch	1800	12109	■	7. Stamen Cover Stitch	0824	22148
■	8. Dark Red Flowers Placement Stitch.....	1912	12133	■	3. Dark Red Petal Placement Stitch	1912	12133	12489-31 Quilt Design 31 ZigZag			
■	9. Dark Red Flowers Cut Line & Tackdown.....	1912	12133	■	4. Dark Red Petal Cover Stitch	1912	12133	■	1. Dark Red Flower Placement Stitch	1912	12133
■	10. Dark Red Flowers Cover Stitch.....	1912	12133	■	5. Stamen Placement Stitch	0532	20139	■	2. Dark Red Flower Tackdown.....	1912	12133
■	11. Light Yellow Flowers Placement Stitch	0532	20139	■	6. Stamen Cover Stitch	0532	20139	■	3. Light Red Petals	1800	12109
■	12. Light Yellow Flowers Cut Line & Tackdown ...	0532	20139	12489-28s Quilt Design 28 Satin				■	4. Light Yellow Stamen	0532	20139
■	13. Light Yellow Flowers Cover Stitch	0532	20139	■	1. Red Flower Placement Stitch	1800	12109	12489-31s Quilt Design 31 Satin			
■	14. Dark Yellow Stamens	0824	22148	■	2. Red Flower Cut Line & Tackdown	1800	12109	■	1. Flower Placement Stitch.....	1912	12133
■	15. Dark Yellow Flowers Placement Stitch	0824	22148	■	3. Red Flower Cover Stitch	1800	12109	■	2. Flower Cut Line & Tackdown	1912	12133
■	16. Dark Yellow Flowers Cut Line & Tackdown ...	0824	22148	■	4. Dark Red Petal Placement Stitch	1912	12133	■	3. Flower Cover Stitch	1912	12133
■	17. Dark Yellow Flowers Cover Stitch	0824	22148	■	5. Dark Red Petal Cut Line & Tackdown	1912	12133	■	4. Light Red Petals	1800	12109
■	18. Brown Petals	0747	18185	■	6. Dark Red Petal Cover Stitch	1912	12133	■	5. Light Yellow Stamen	0532	20139
■	19. Brown Stamen Placement Stitch	0747	18185	■	7. Stamen Placement Stitch	0532	20139	12489-32 Quilt Design 32 ZigZag			
■	20. Brown Stamen Cut Line & Tackdown	0747	18185	■	8. Stamen Cut Line & Tackdown	0532	20139	■	1. Red Flower Placement Stitch	1800	12109
■	21. Brown Stamen Cover Stitch	0747	18185	■	9. Stamen Cover Stitch	0532	20139	■	2. Red Flower Tackdown	1800	12109
■	22. Light Yellow Stamen	0532	20139	12489-29 Quilt Design 29 ZigZag				■	3. Stamen	0532	20139
■	23. Dark Green Details.....	5324	18202	■	1. Flower Placement Stitch.....	1912	12133	12489-32s Quilt Design 32 Satin			
12489-26 Quilt Design 26 ZigZag											
■	1. Dark Green Leaves Placement Stitch	5324	18202	■	2. Flower Tackdown.....	1912	12133	■	1. Red Flower Placement Stitch	1800	12109
■	2. Dark Green Leaves Tackdown & Stems.....	5324	18202	■	3. Light Yellow Petals	0532	20139	■	2. Red Flower Cut Line & Tackdown	1800	12109
■	3. Berry Placement Stitch.....	1800	12109	12489-29s Quilt Design 29 Satin				■	3. Red Flower Cover Stitch	1800	12109
■	4. Berry Tackdown.....	1800	12109	■	1. Flower Placement Stitch.....	1912	12133	■	4. Stamen	0532	20139
12489-26s Quilt Design 26 Satin											
■	1. Dark Green Leaves Placement Stitch	5324	18202	■	2. Flower Cut Line & Tackdown	1912	12133	12489-33 Quilt Design 33 Linework			
■	2. Dark Green Leaves Cut Line & Tackdown.....	5324	18202	■	3. Flower Cover Stitch.....	1912	12133	■	1. Single Color Design.....	1912	12133
■	3. Dark Green Leaves Cover Stitch & Stems ...	5324	18202	■	4. Light Yellow Petals	0532	20139	12489-30 Quilt Design 30 ZigZag			
■	4. Berry Placement Stitch.....	1800	12109	■	1. Dark Red Flower Placement Stitch	1912	12133	■	1. Dark Red Flower Placement Stitch	1912	12133
■	5. Berry Cut Line & Tackdown	1800	12109	■	2. Dark Red Flower Tackdown.....	1912	12133	■	2. Dark Red Flower Tackdown.....	1912	12133
■	6. Berry Cover Stitch	1800	12109	■	3. Red Inner Flower.....	1800	12109	■	3. Red Inner Flower.....	1800	12109
12489-27 Quilt Design 27 ZigZag											
■	1. Dark Green Leaves Placement Stitch	5324	18202	■	4. Stamen Placement Stitch.....	0824	22148	■	4. Stamen Placement Stitch.....	0824	22148
■	2. Dark Green Leaves Tackdown	5324	18202	■	5. Stamen Tackdown	0824	22148	■	5. Stamen Tackdown	0824	22148
■	3. Berries	1800	12109								



Supplies for One Block:

- 14" square of background fabric (will be trimmed to 10.5" square when complete)
- Scraps for applique
- 14" square of batting
- 14" square of cut-away mesh (fusible, or used with temporary adhesive spray)
- Temporary adhesive spray
- Temporary marking pen



Photo 1



Photo 2

Instructions:

1. Print the template for the block you want to create. **(Photo 1)**.
 2. Lightly spray your batting with temporary adhesive spray. Center fabric over your batting.
 3. Lightly spray your mesh cut-away stabilizer with temporary adhesive spray and add to the back of your batting. You now have a quilt "sandwich".
 4. Mark the center of your 14" square with a temporary marking pen. **(Photo 2)**.
 5. Print your template for the desired block. Cut or punch a small hole at each design centerpoint.
 6. Align the "center" mark on the template with your marked center on your 14" square. Pin in place if needed. **(Photo 3)**.
 7. Mark the center of each design onto your fabric. **(Photos 4-6)**
- **NOTE:** You may find it helpful to mark the design numbers and orientation of each design.



Photo 3

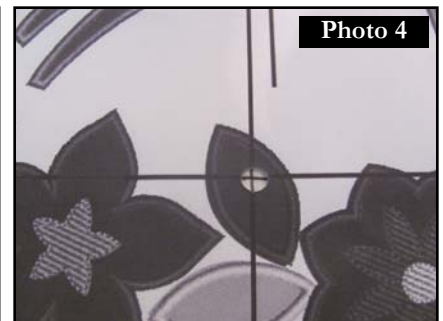

Photo 4



Photo 5

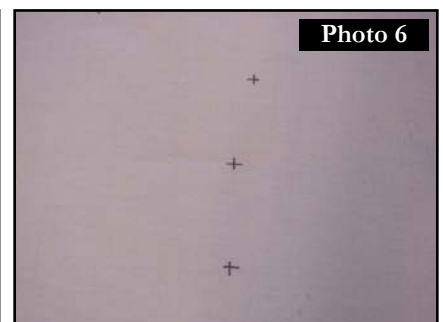

Photo 6

8. Hoop your fabric, batting, and stabilizer together as one, centering the marked centerpoint of your first design in the center of your embroidery hoop. **(Photo 7)**.
9. Place the hoop onto the machine and select the appropriate design. Check your design position, using your machine's functions to adjust the design's position in the hoop as needed. **(Photos 8 and 9)**
10. Stitch the design, following included instructions for machine appliqué. You may choose to pre-cut your appliqué pieces, or trim them in place. **(Photo 10)**
11. When the design is complete, remove hoop from machine. **(Photo 11)**
12. Remove the fabric from hoop. Re-hoop your square, centering your next marked centerpoint in the center of your embroidery hoop. Be sure to orient the fabric correctly according to the orientation of the design noted on the centerpoint sheet. **(Photo 12)**
13. Place hoop on the machine and select the appropriate design. Check your design position, using your machine's functions to adjust the design's position in the hoop as needed. **(Photos 13 and 14)**.
14. Remove your fabric from your hoop and trim any jump stitches. **(Photo 15)**
15. Remove any markings. Press your block from the backside. Trim your block to 10.5" square, making sure the finished appliqué remains in the center of the block as you trim.

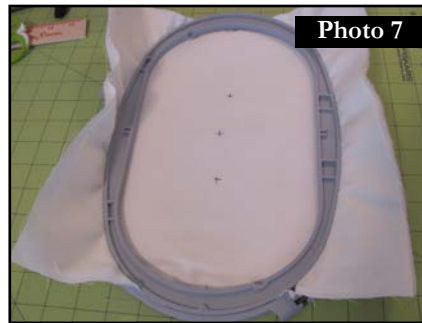

Photo 7



Photo 8



Photo 9

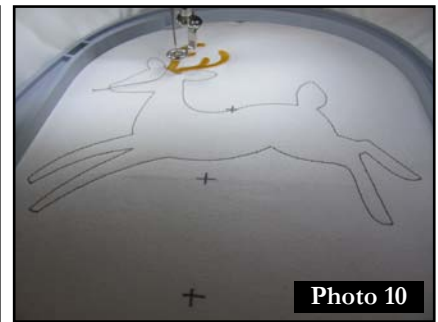

Photo 10



Photo 11



Photo 12



Photo 13



Photo 14



Photo 15

Suggested Layout:



1. Print out the necessary pages from the PDF of the appliqué pattern(s).
2. Mark the right side of the pattern pieces so you'll know which direction to lay the pattern on the fabric.
3. Lightly spray the wrong side of the pattern pieces with temporary adhesive spray and allow it to set for a few minutes.
4. Place the pattern pieces on the right side of the fabric and carefully cut them out. **PHOTO 1**
5. Sew the placement stitch on your hooped fabric. **PHOTO 2**
6. With the paper still stuck to the right side of the appliqué fabric, spray the wrong side of the fabric with temporary spray adhesive.
7. Place the fabric inside the sewing placement stitch so that it matches the stitching line, and then remove the paper pattern. **PHOTO 3**
8. Sew the tackdown. **PHOTO 4**
9. Sew the remainder of the design and repeat for any remaining pieces. **PHOTO 5**

NOTE: The patterns are sized for the designs as they were made. If you resize the design, you will need to resize the pattern the same amount. You can print out the pattern at the normal size then copy it on a copy machine at the changed size. For example, resize the designs to 80%, resize the printed pattern to 80%.

TIP: When Printing the patterns, make sure that the “Fit to page” option is **UNCHECKED** in the Print Dialog Box. If this option is checked the printed patterns will not be actual size.

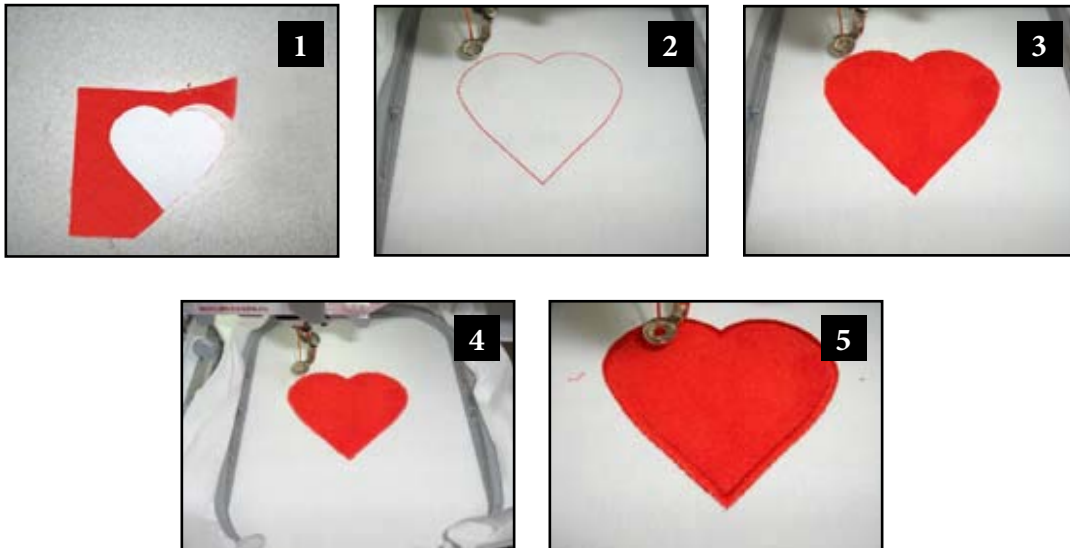

ATTENTION

When printing this document, any page scaling or page fitting options in your print dialog box must be turned OFF or set to NONE so that your files will print out at their actual size. Images not printed at actual size will not function as intended.

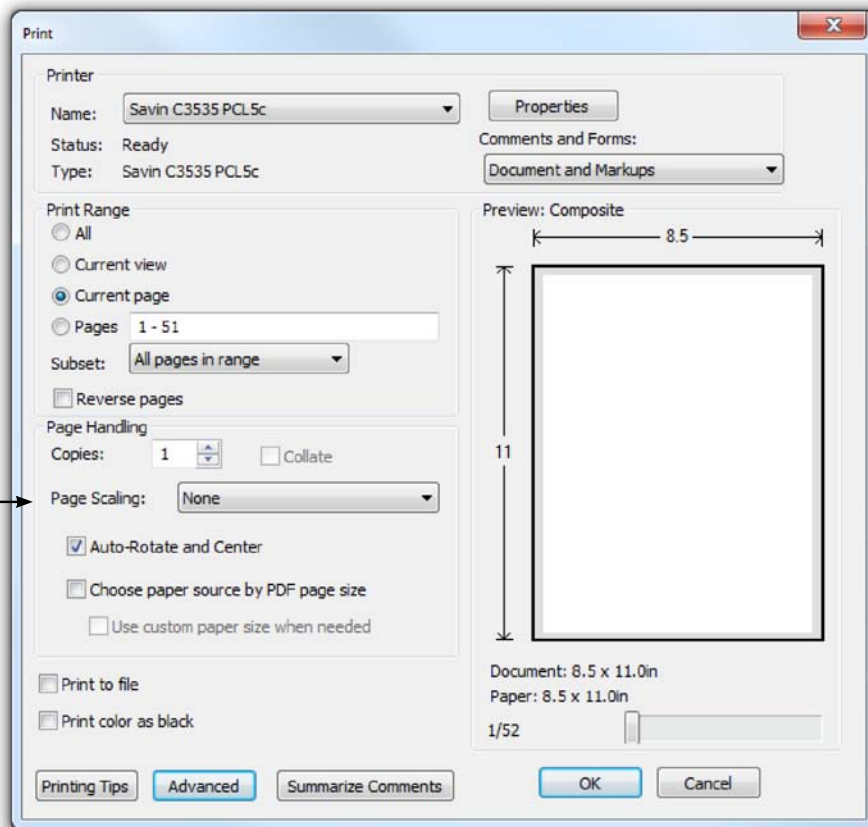

TO SAVE PAPER

Only print the desired image by navigating to the image's page, go to File > Print and select "Current page" in the print dialog box. Repeat for each desired image.

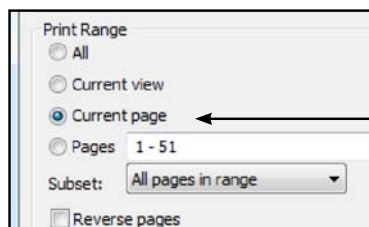

12489-01
1st Placement
Lt. Green Leaves

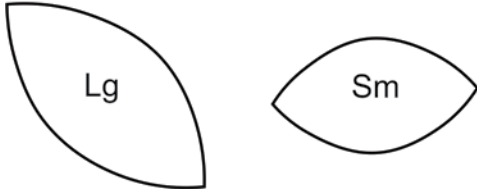

12489-01
2nd Placement
Dk. Green Leaves

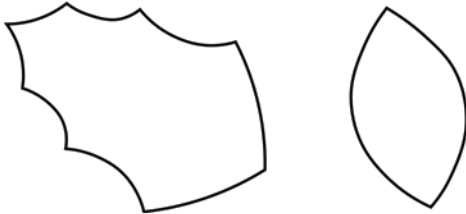

12489-01
3rd Placement
Berries

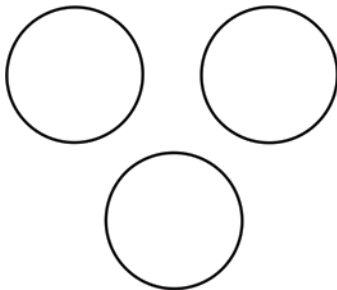

12489-01
Last Placement
Flower

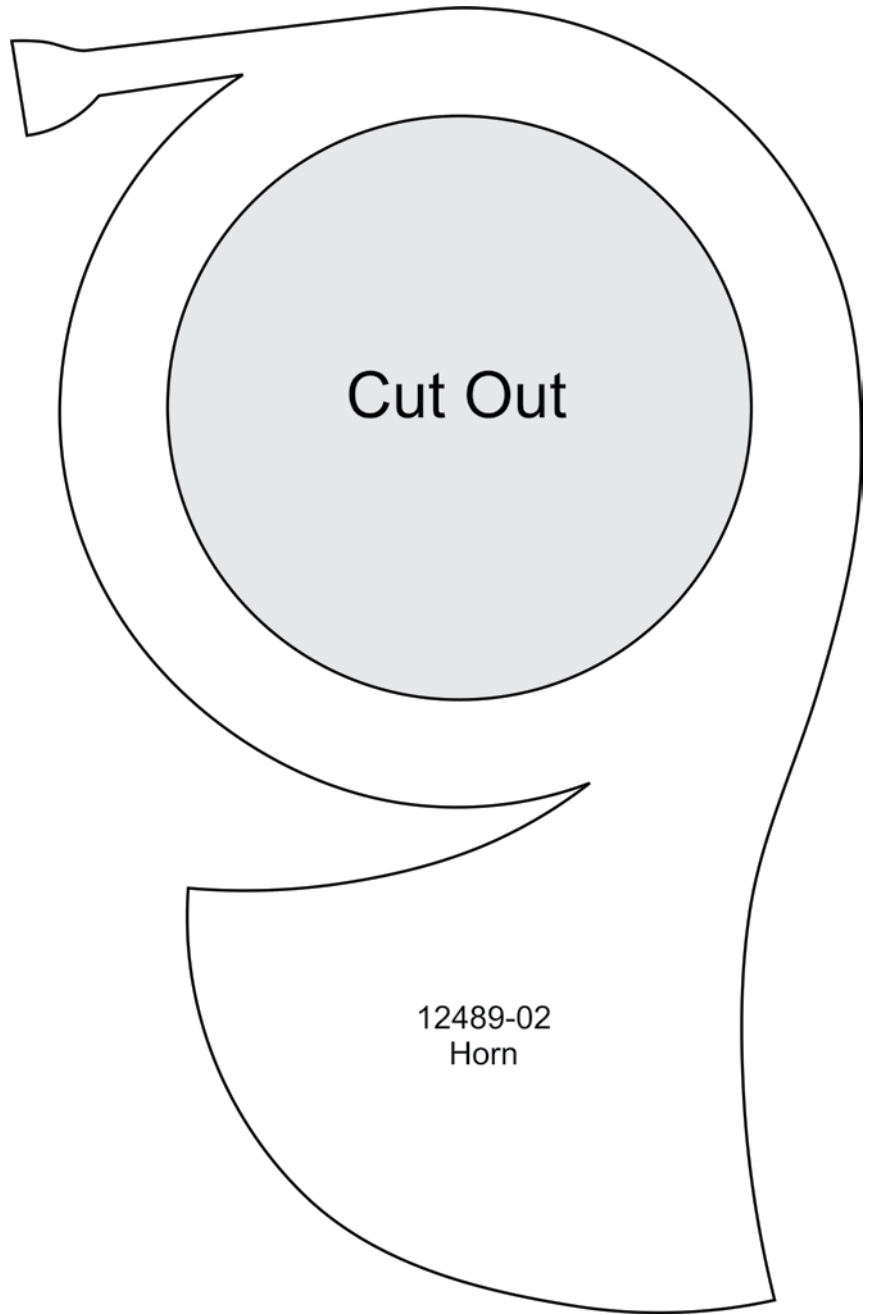
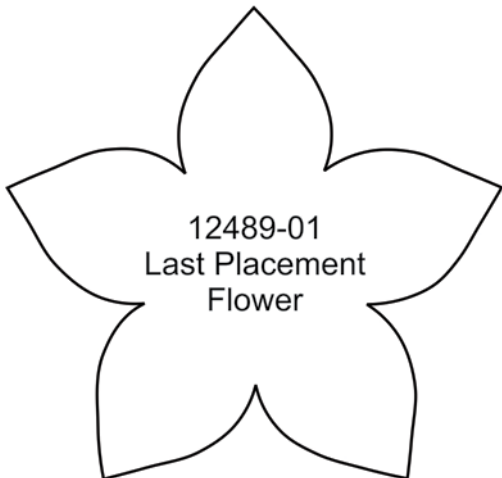

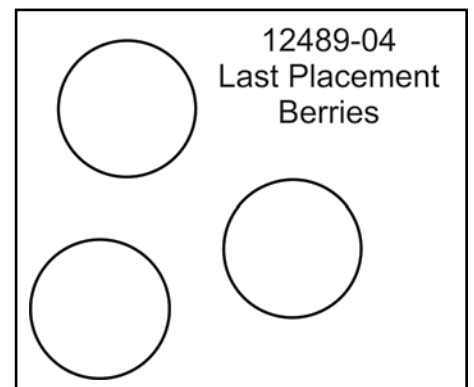
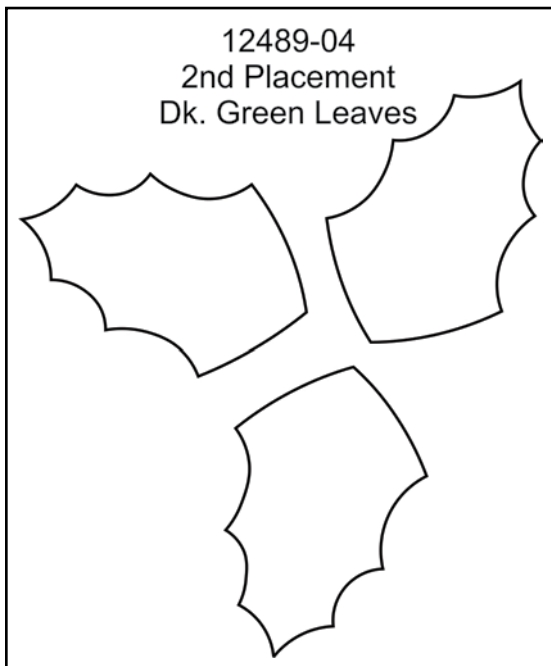
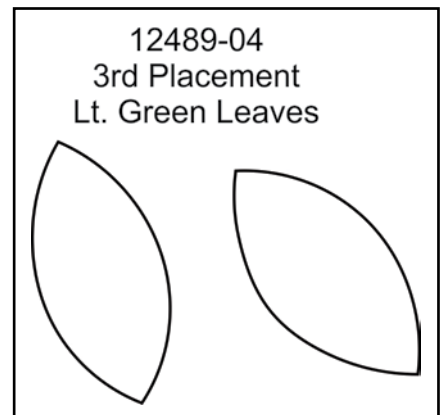
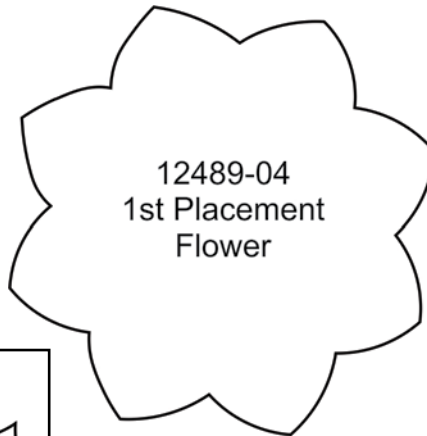
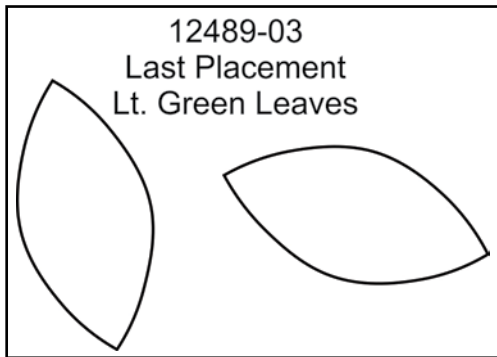
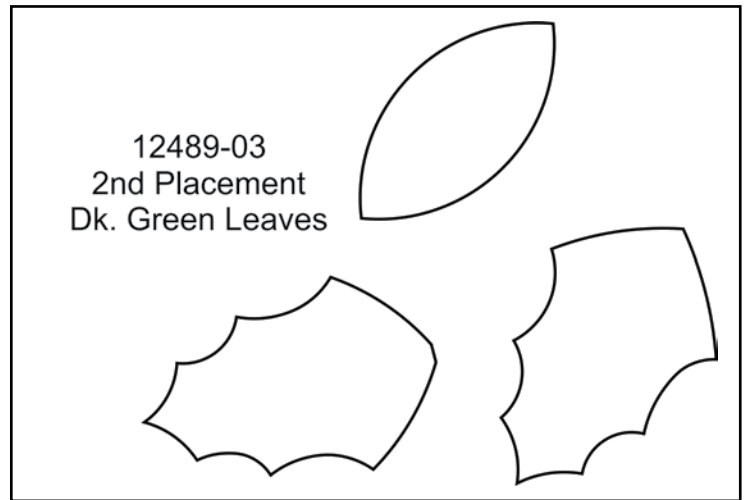
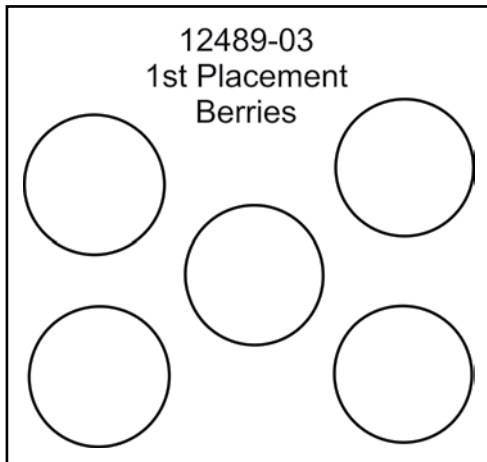

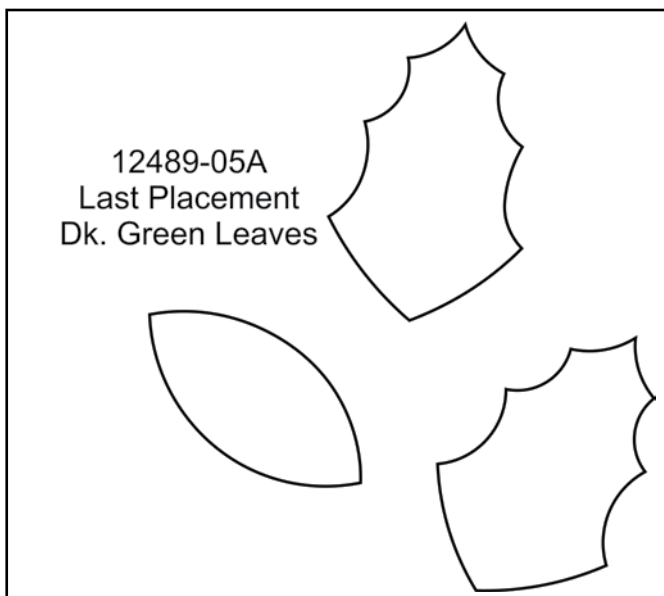
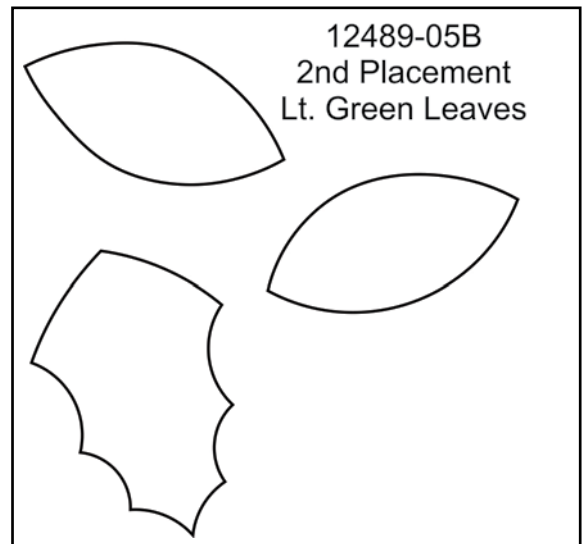
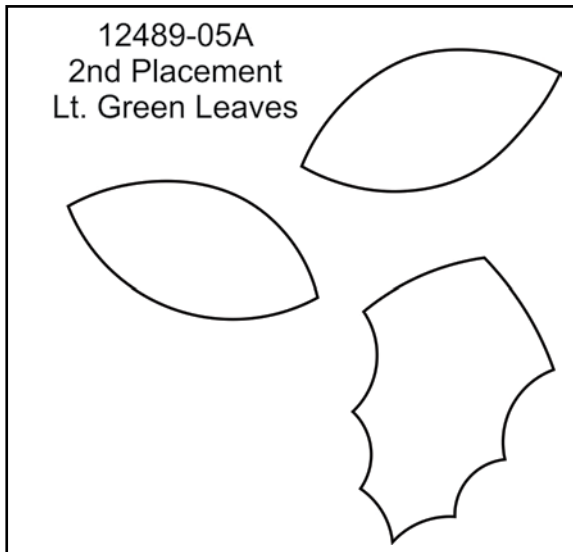
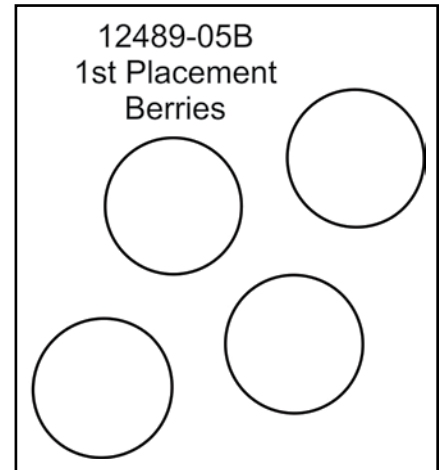
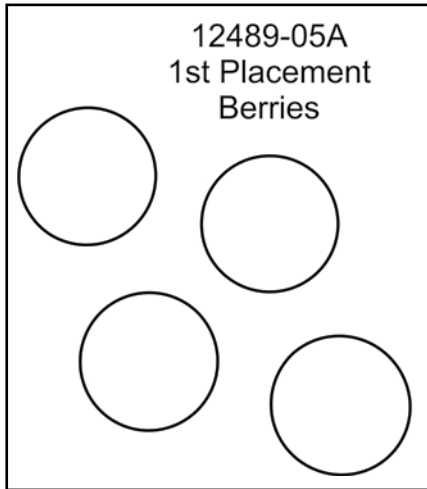

12489-06
Last Placement
Star

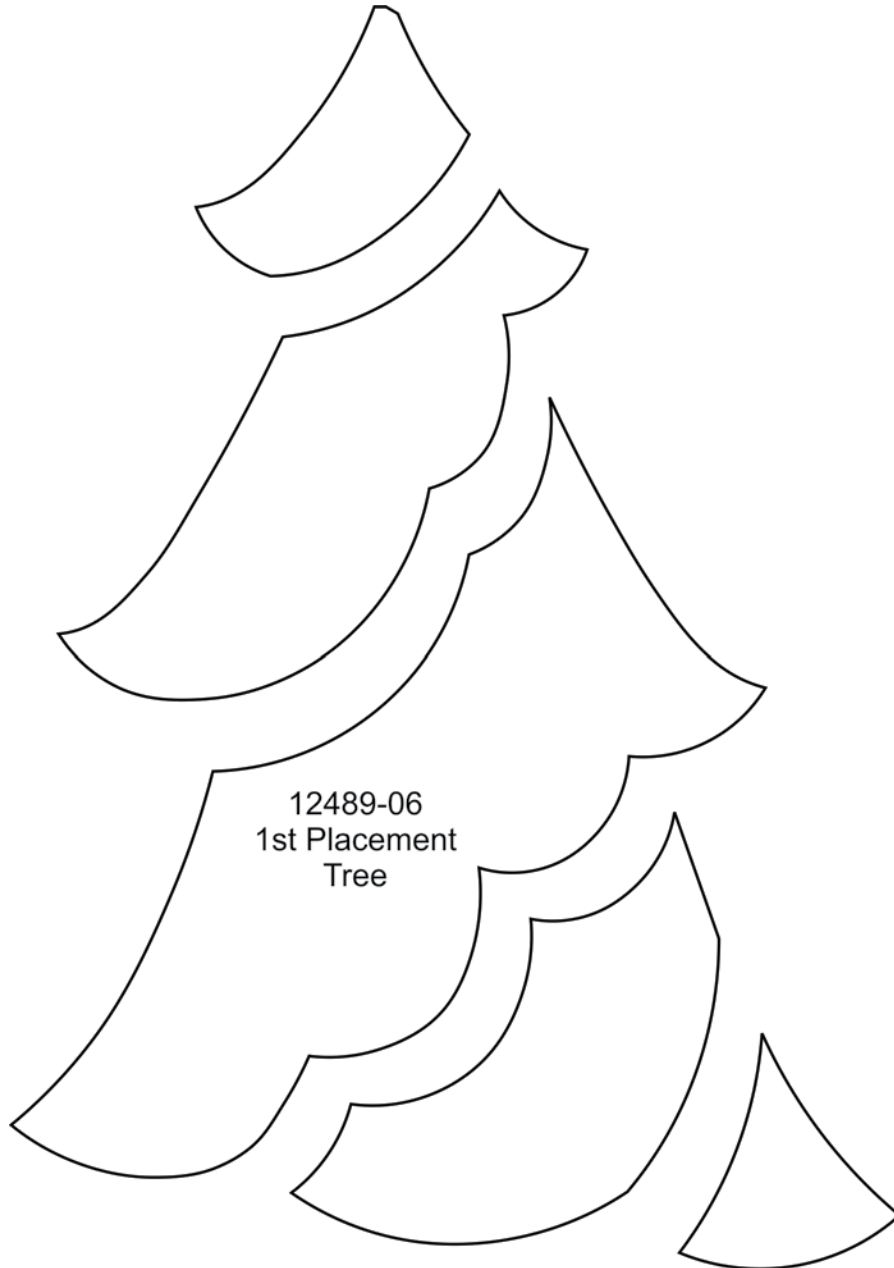

12489-06
1st Placement
Tree

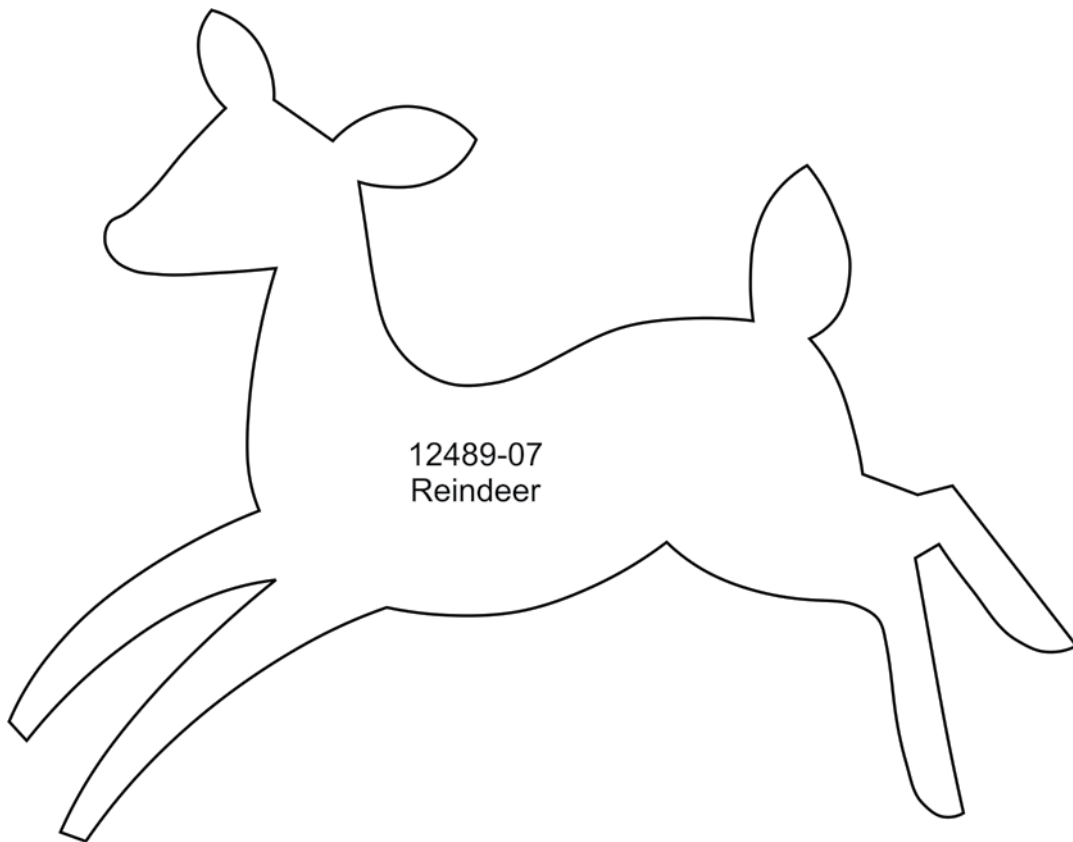

12489-08
1st Placement
Lt. Green Leaves

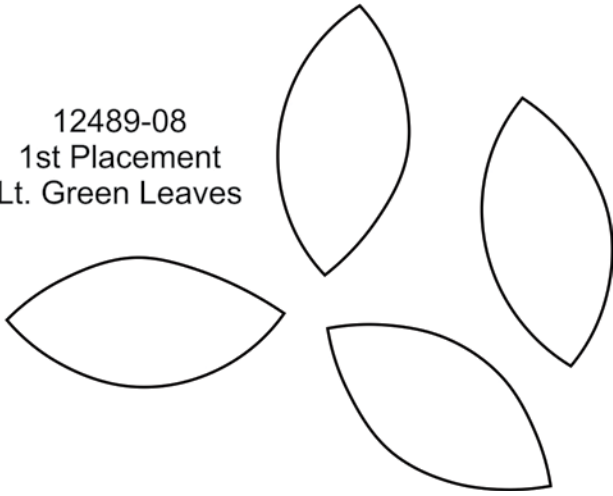

12489-08
3rd Placement
Bud and Berries

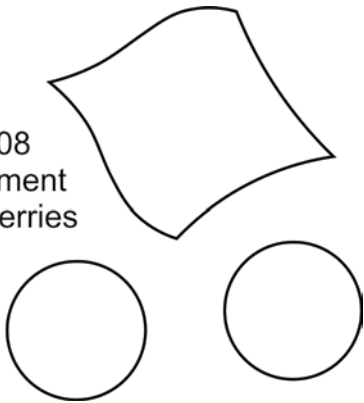

12489-08
2nd Placement
Dk. Green Leaves

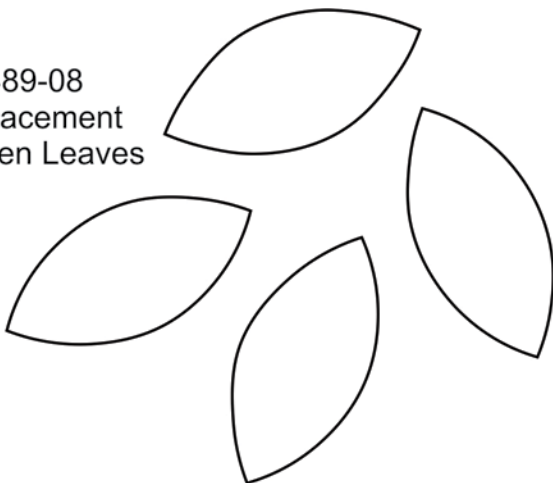

12489-08
Last Placement
Flowers

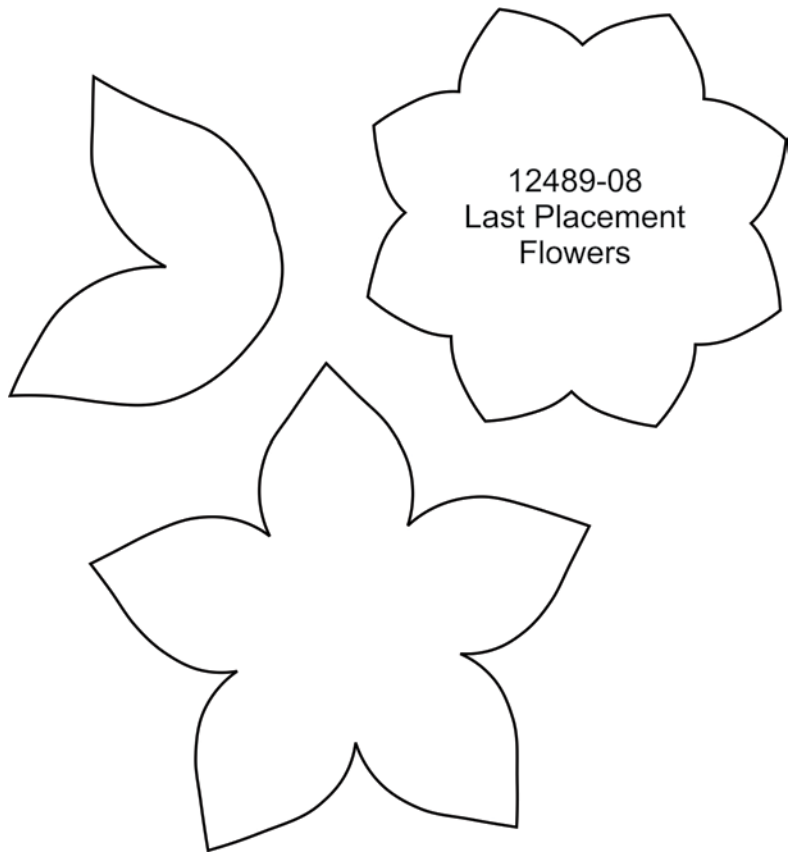

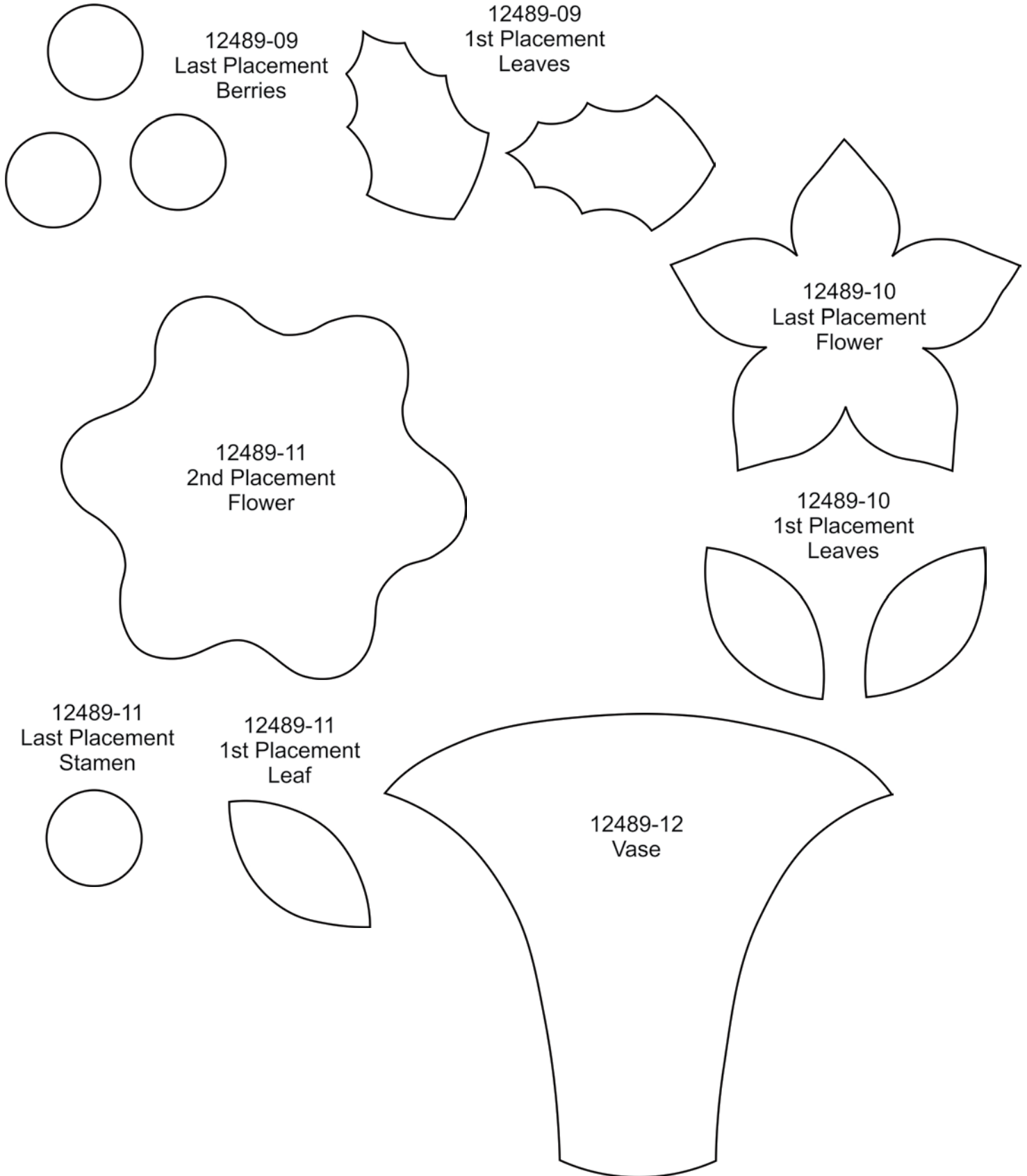

12489-13
1st Placement
Dk. Green Leaves

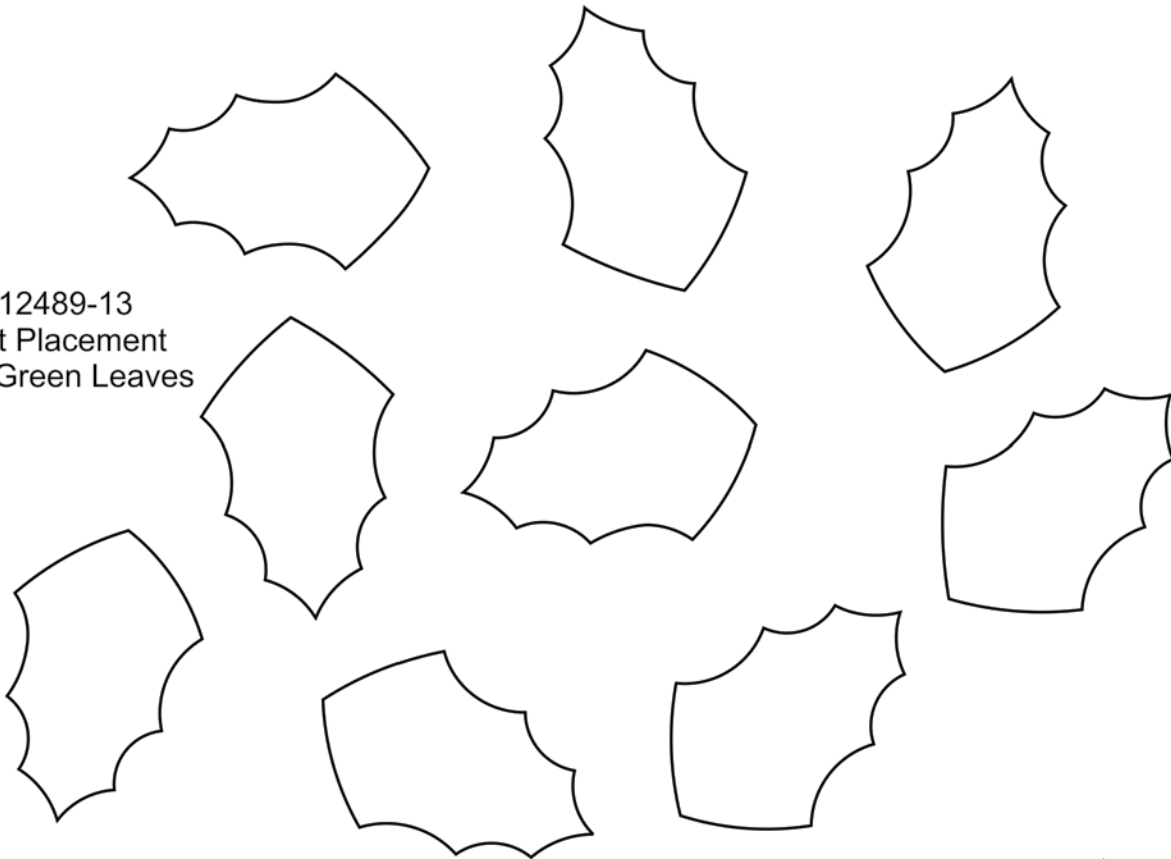

12489-13
2nd Placement
Berries

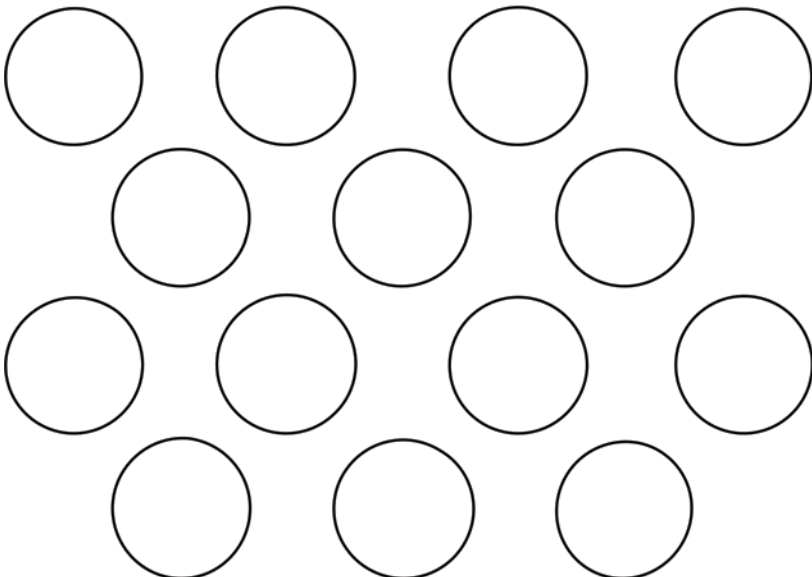

12489-13
Last Placement
Lt. Green Leaves

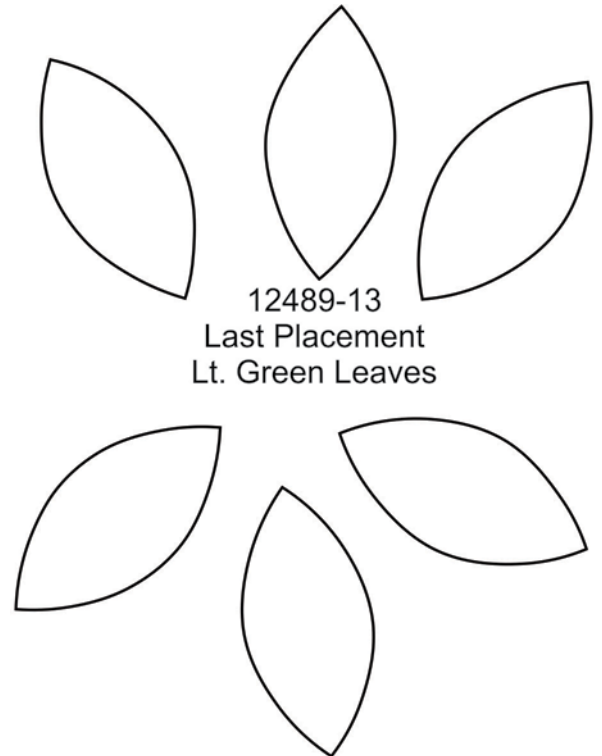

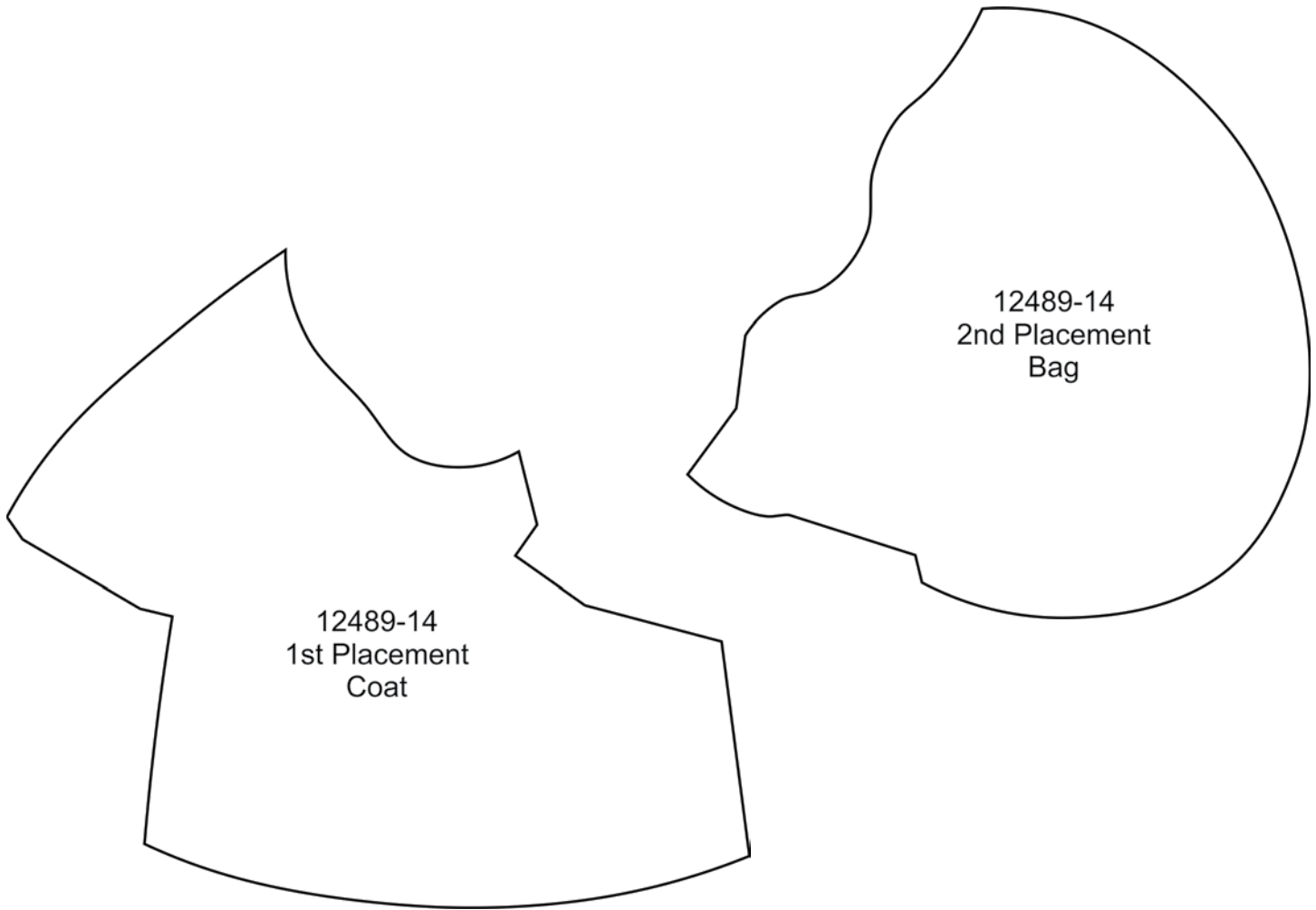

12489-14
1st Placement
Coat

12489-14
2nd Placement
Bag

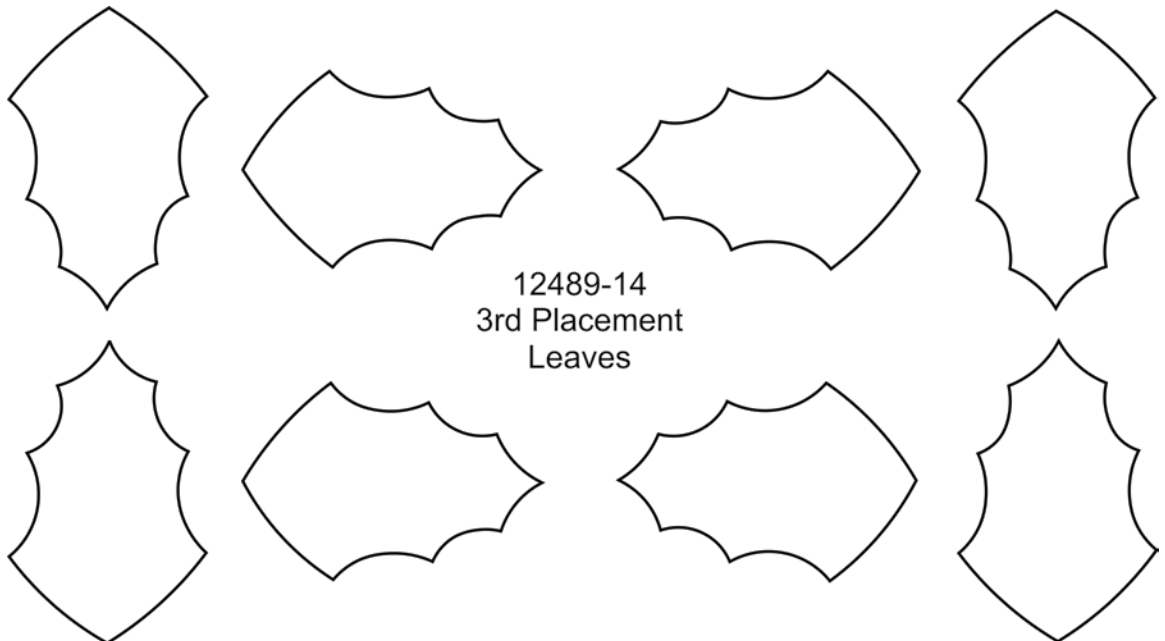

12489-14
3rd Placement
Leaves

12489-14
4th Placement
Hat & Elbow



12489-14
Last Placement
Beard & Suit Trim

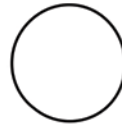
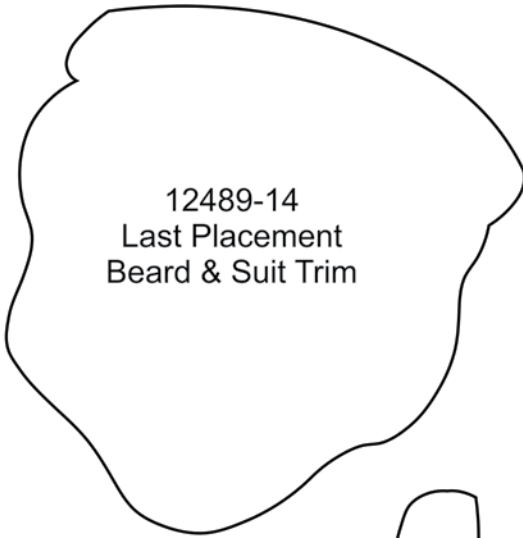

12489-15
1st Placement
Leaves

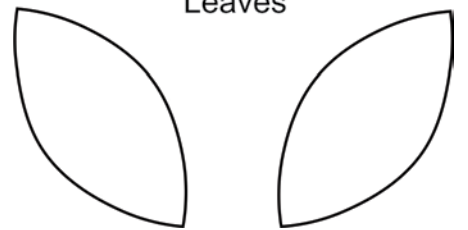

12489-15
Last Placement
Star

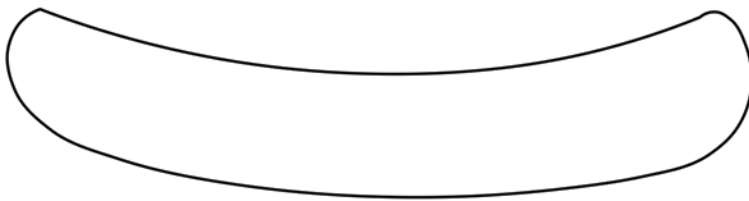
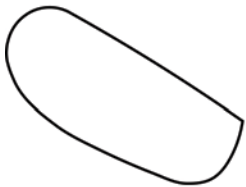

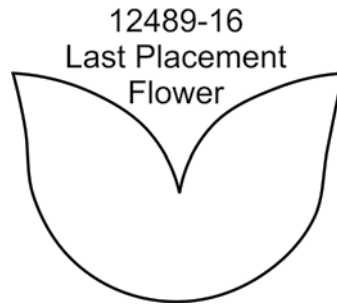

12489-17A
1st Placement
Bud, Flower, Berries

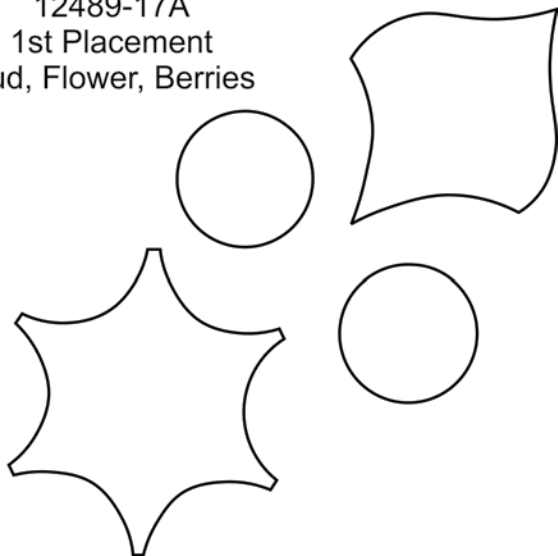

12489-17A
3rd Placement
Dk. Green Leaves

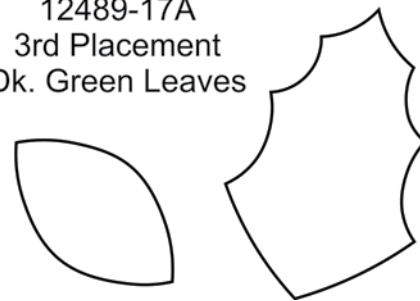

12489-17A
Last Placement
Lt. Green Leaves



12489-17A
2nd Placement
Flower



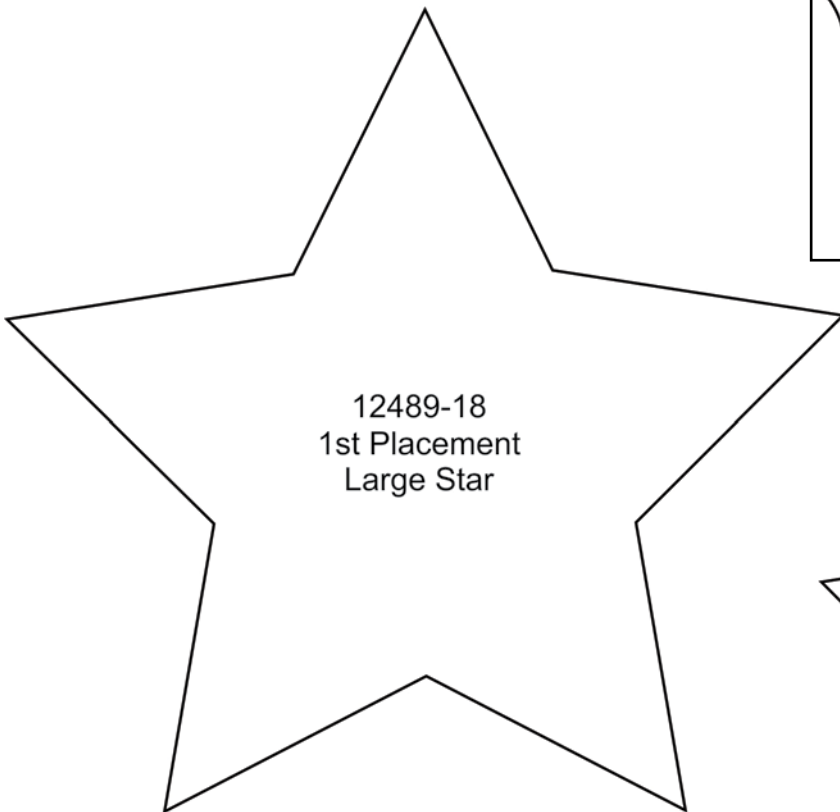
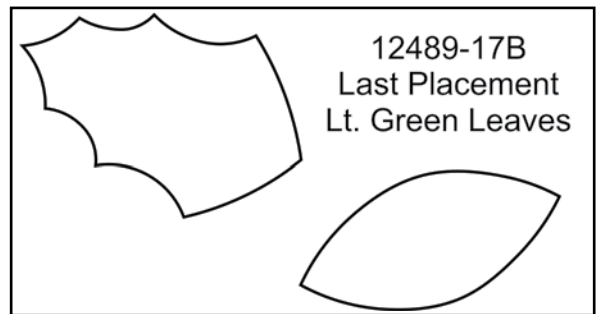
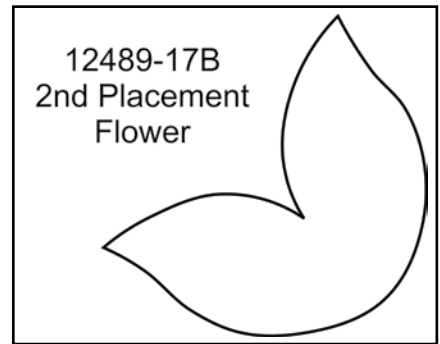
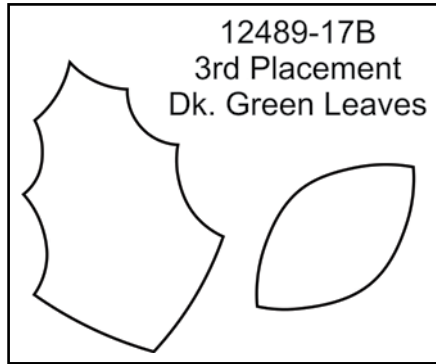
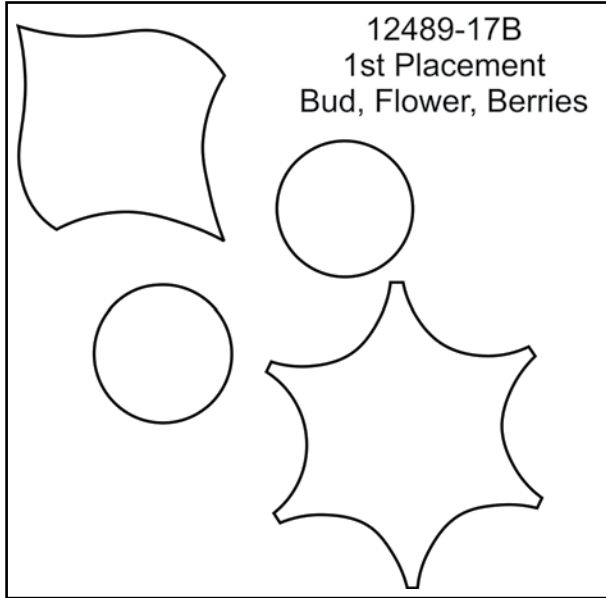

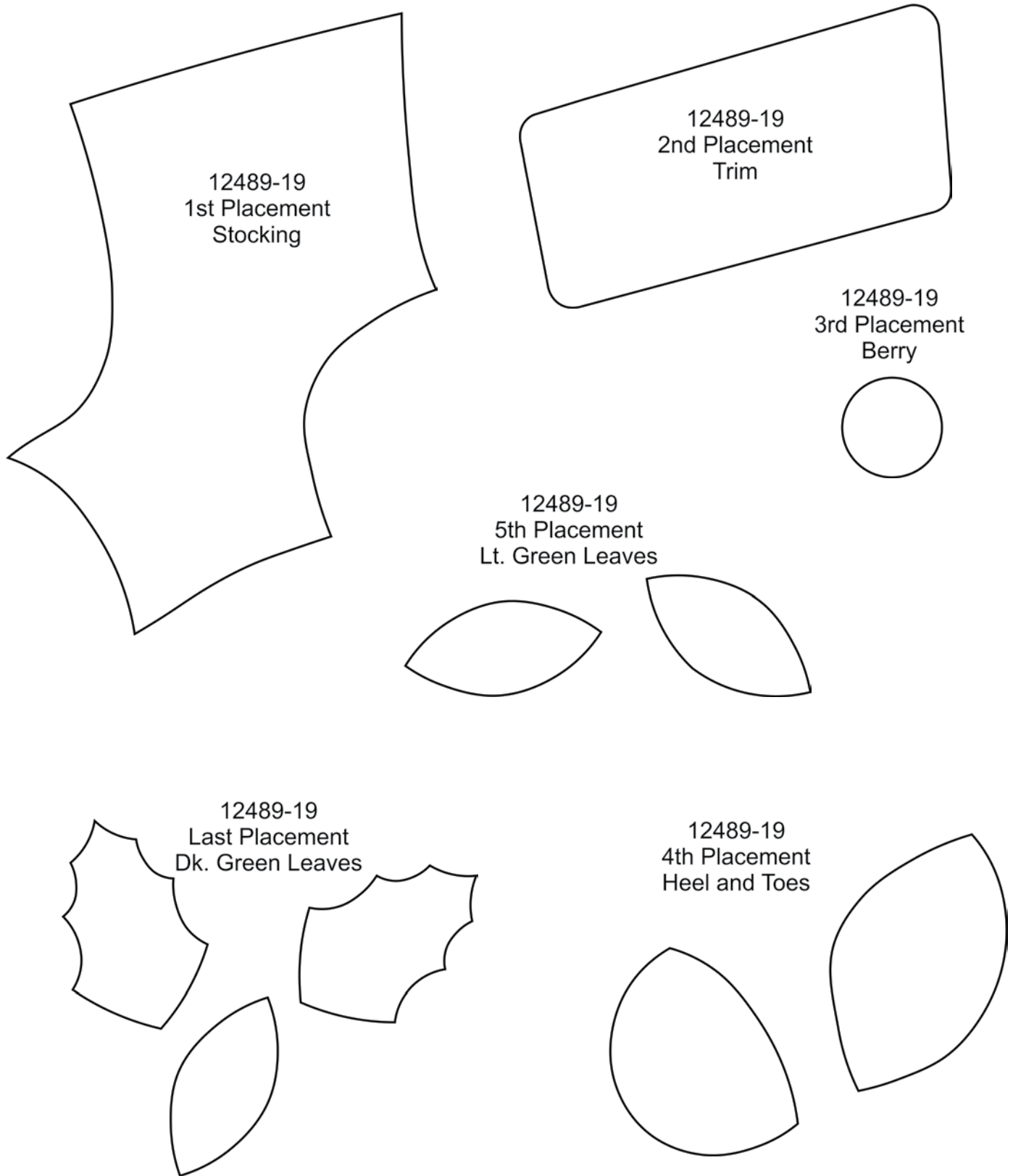

12489-20
1st Placement
Dk. Green Leaves

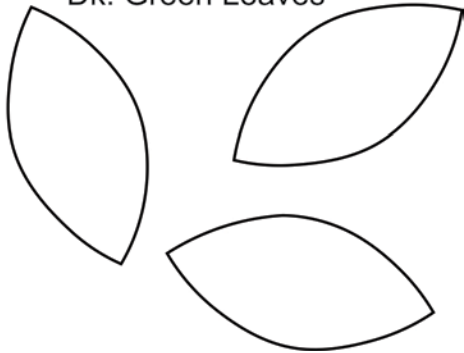

12489-20
2nd Placement
Lt. Green Leaves

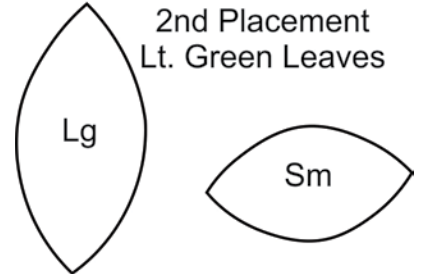

12489-20
3rd Placement
Flower

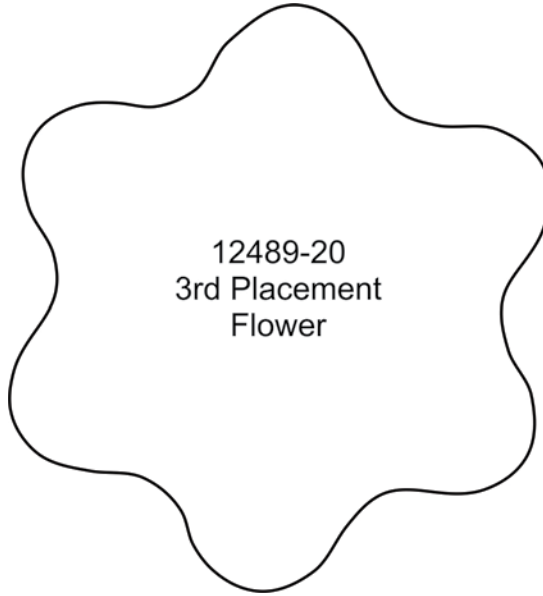

12489-20
Last Placement
Stamen

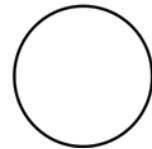

12489-21
2nd Placement
Top Left Gift

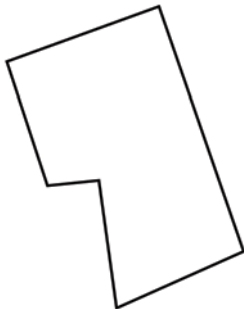

12489-21
1st Placement
Top Right Gift

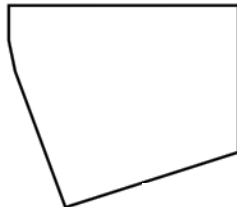

12489-21
3rd Placement
Bottom Right Gift

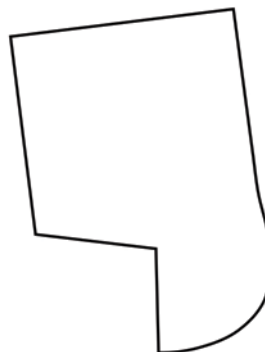

12489-21
4th Placement
Bottom Left Gift



12489-21
Last Placement
Sleigh

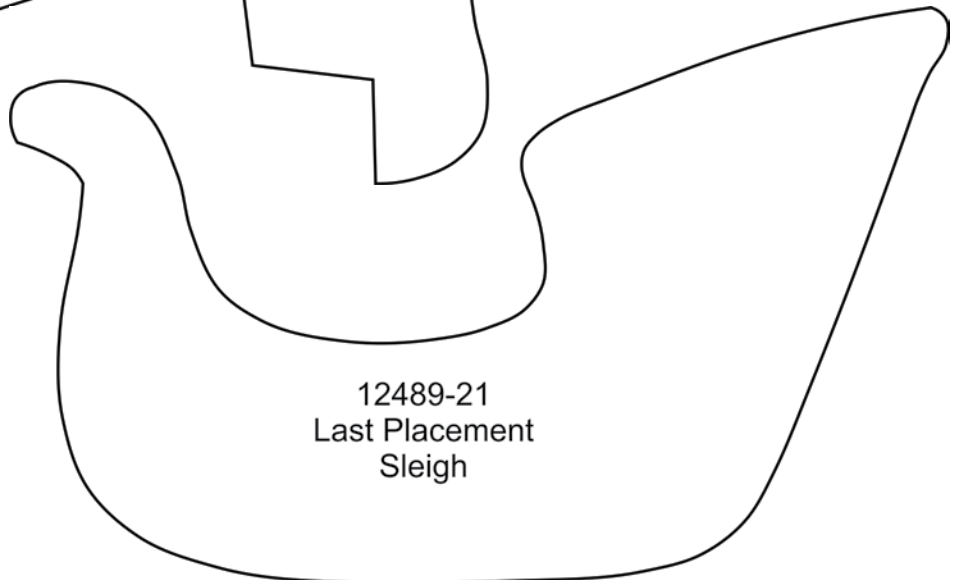

12489-22
1st Placement
Lt. Green Leaves

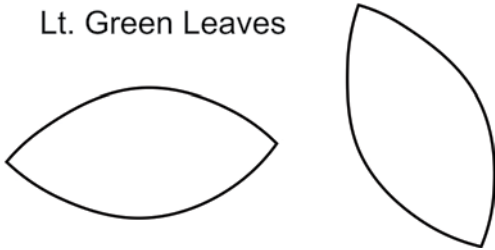

12489-22
2nd Placement
Flowers, Bud, Berries

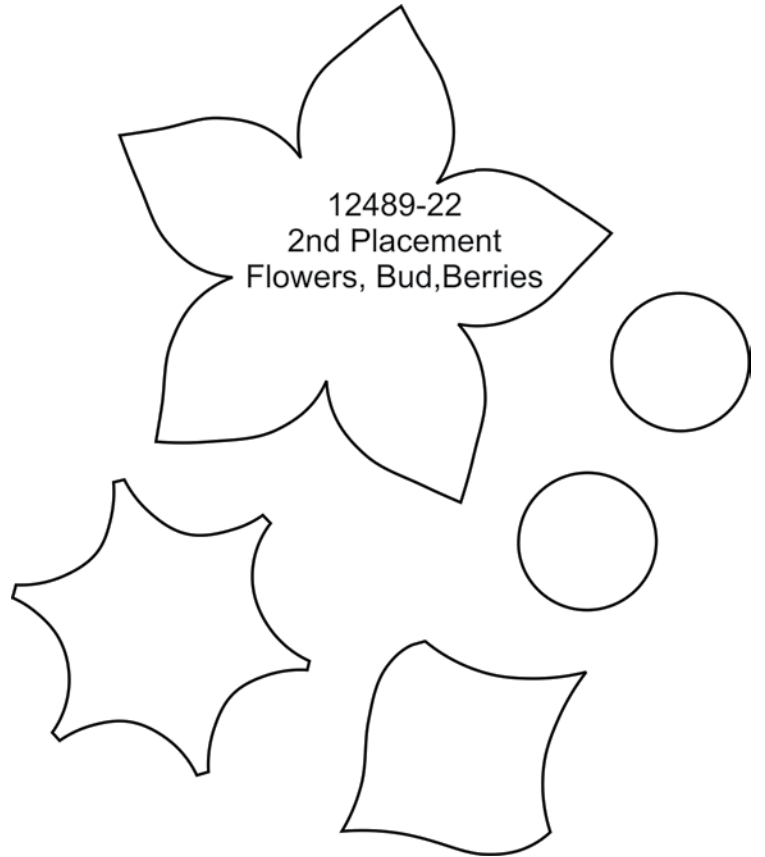

12489-22
Last Placement
Dk. Green Leaves



12489-22
3rd Placement
Flower

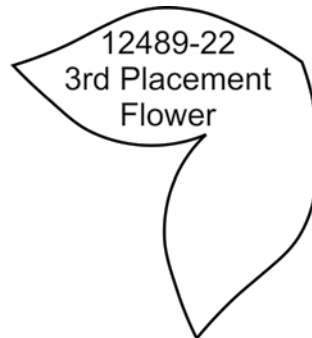

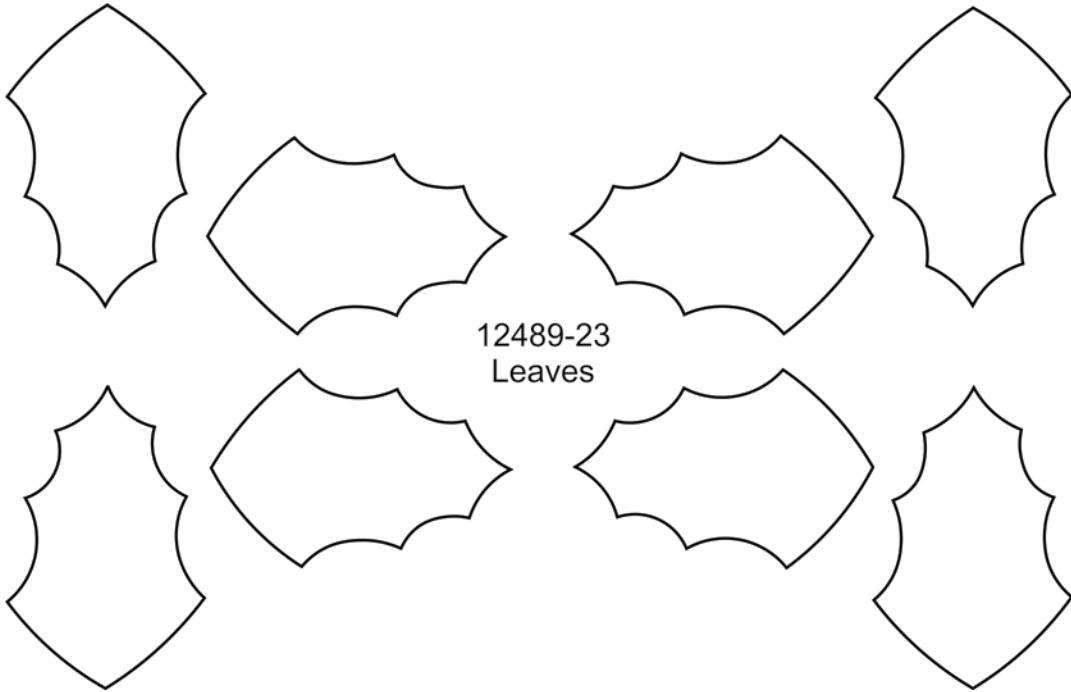

12489-23
Leaves



12489-24
1st Placement
Dk. Green Leaves

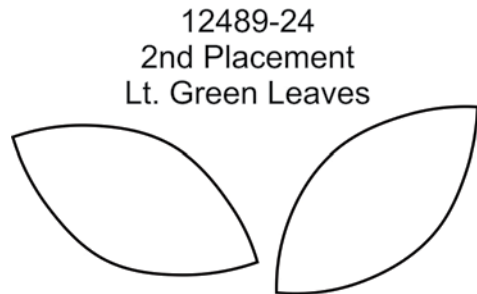

12489-24
2nd Placement
Lt. Green Leaves



12489-24
3rd Placement
Bud



12489-24
Last Placement
Flowers

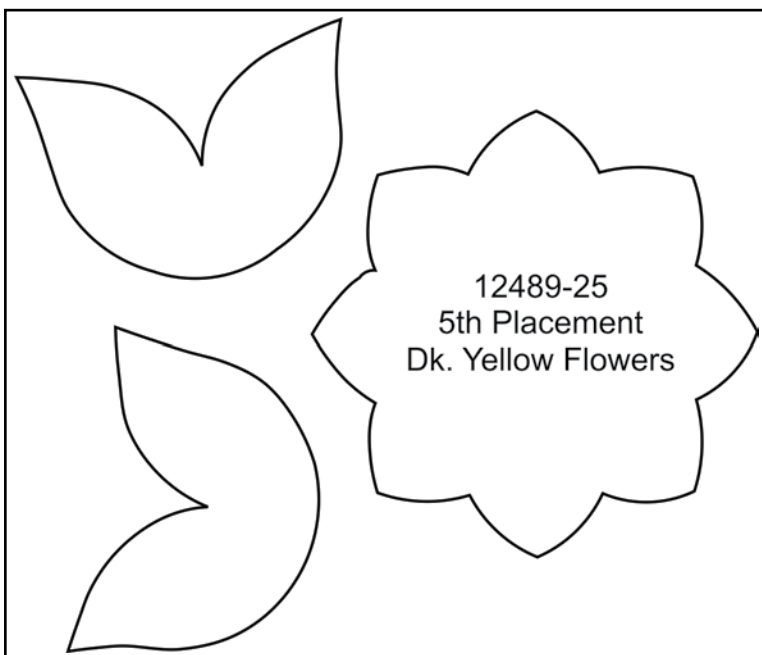
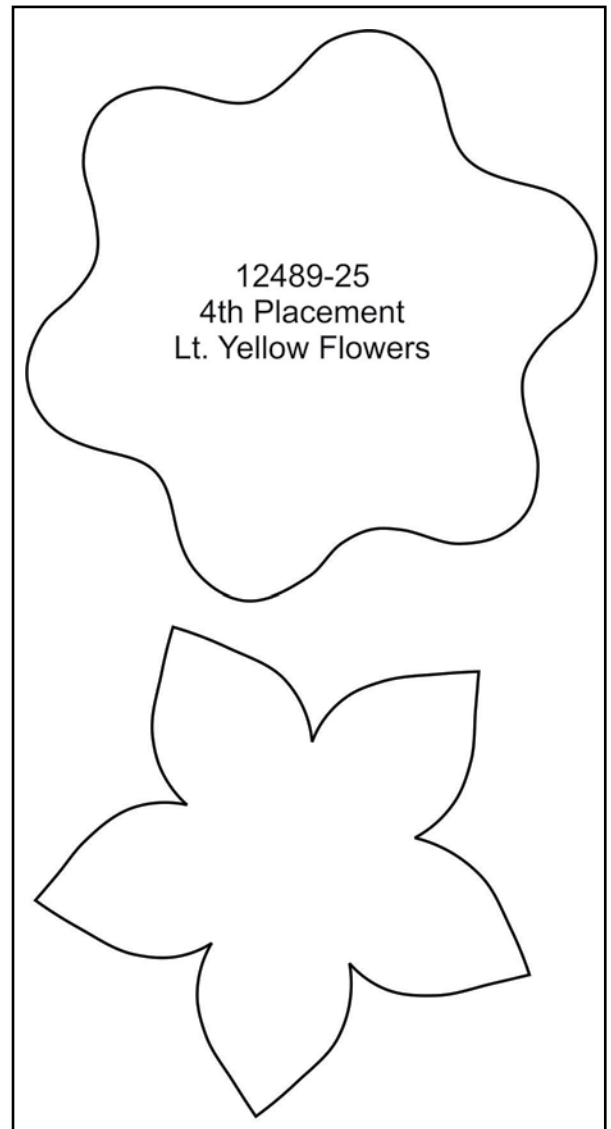
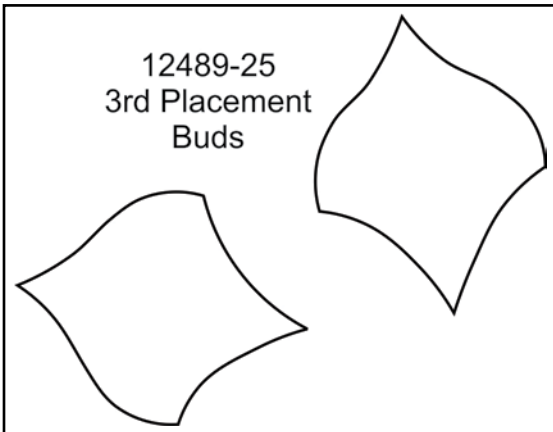
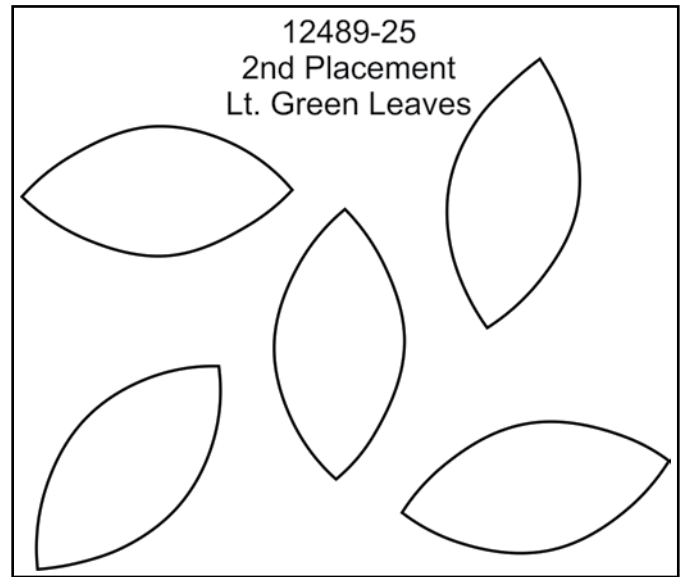
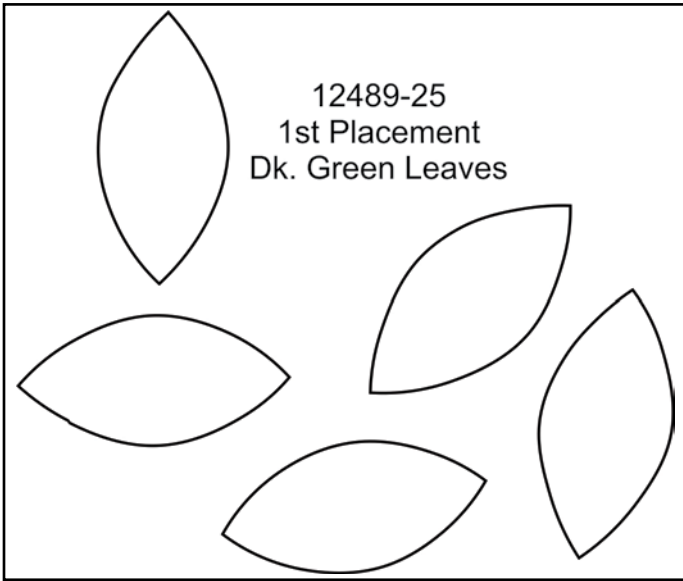

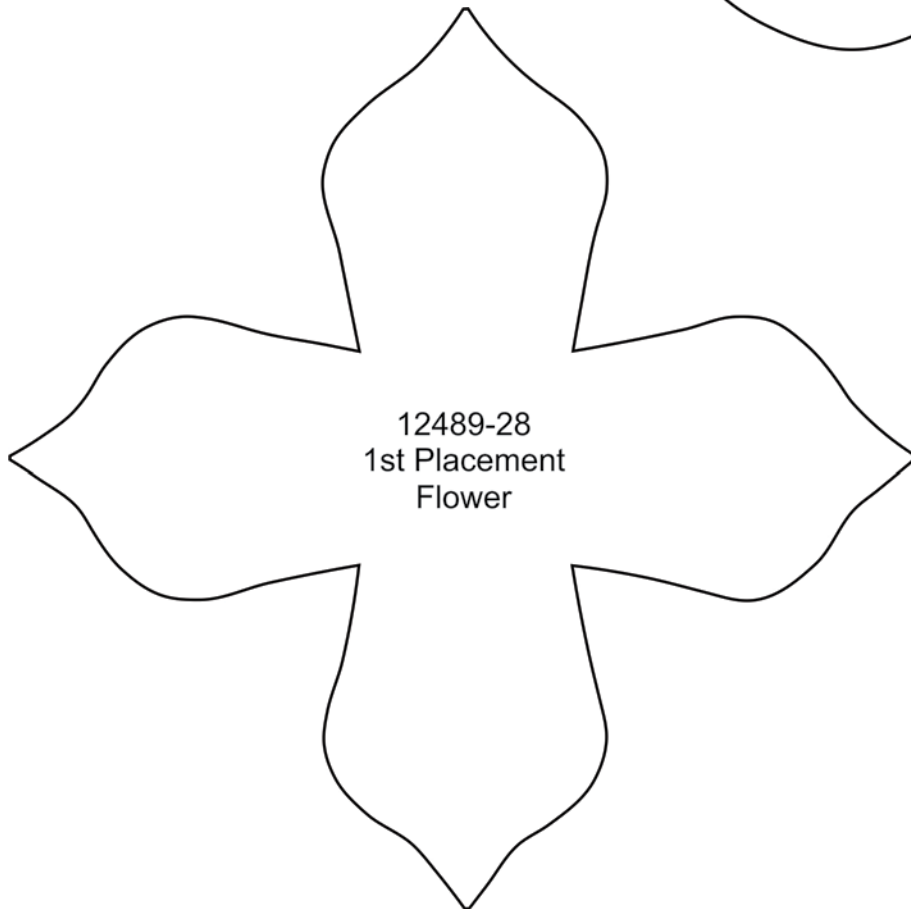
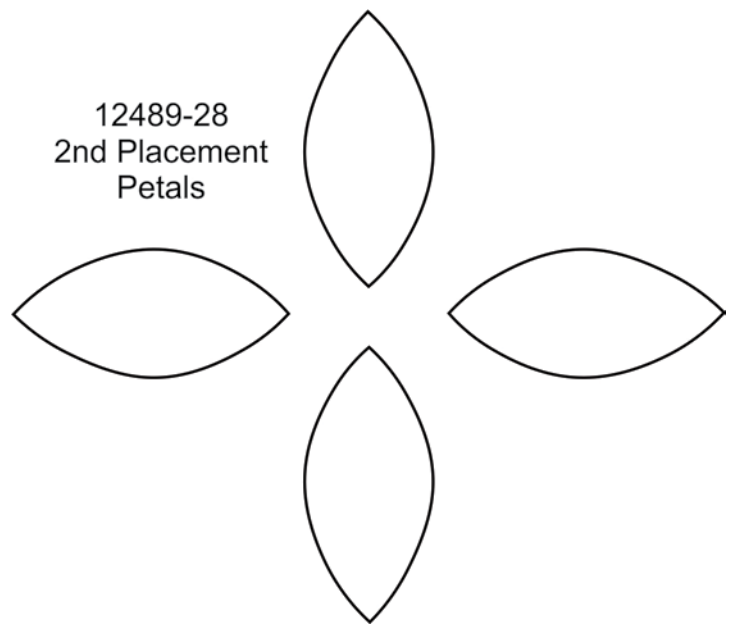
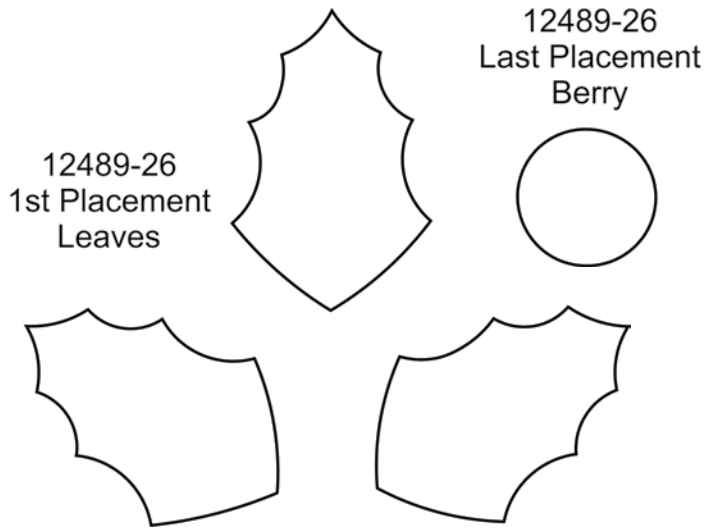

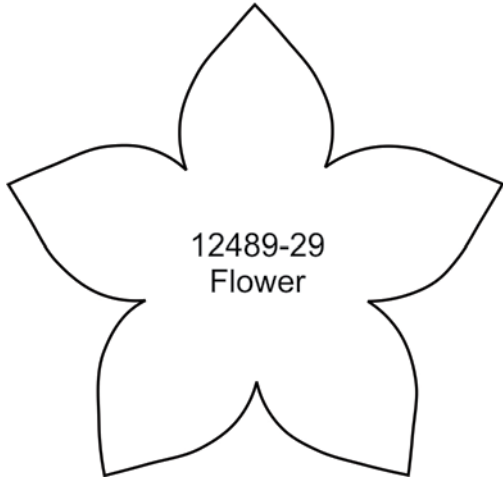

12489-29
Flower

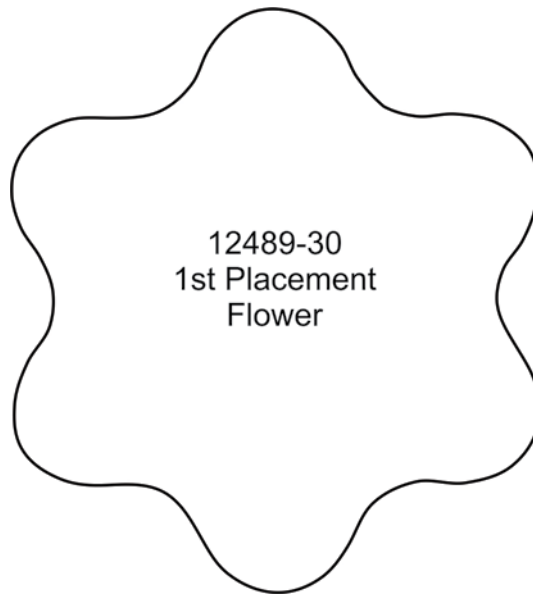

12489-30
1st Placement
Flower

12489-30
Last Placement
Stamen

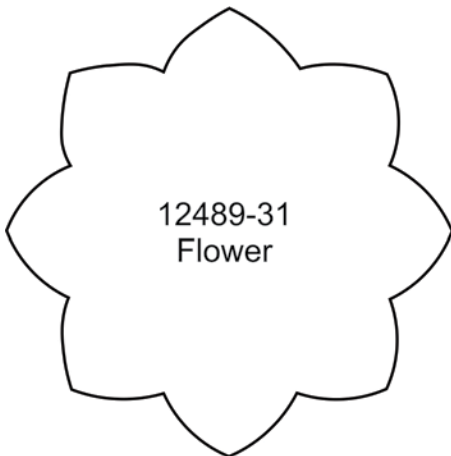
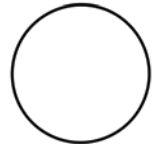

12489-31
Flower



12489-32
Flower