

FREESTANDING SANTA CLAUS



1

Design

Project Instructions Included

THREAD LIST



Isacord Thread Colors

0015 White
1060 Shrimp Pink
1430 Melon
1912 Winterberry
2101 Country Red
4174 Charcoal

*** Project instructions included after design list.**

Note: One spool of 1000 meter thread is adequate for the project unless otherwise noted.

Table of Contents

Designs.....	3
Collection Supplies.....	11
Summary	12
Embroidery	13
Assembly	16
Freestanding Lace Instructions.....	22
Applique Patterns.....	24
Mirrored Patterns.....	29

Interactive menu

Click to navigate to section.

DESIGNS

Note: Some designs in this collection may have been created using unique special stitches and/or techniques. To preserve design integrity when rescaling or rotating designs in your software, always rescale or rotate designs using the handles directly on-screen.

*Fabric Required

12702-01 Santa Robe Slice 1 FSA



Size Inches:	Size mm:	Stitch Count:
3.45 X 8.02 in.	87.63 X 203.71 mm	46,974 St.

- 1. Robe Slice 1 Placement Stitch 0015
- 2. Cut Line & Tackdown 0015
- 3. White Lace 0015
- 4. Damask Detail..... 1912
- 5. Red Lace & Cover Stitch..... 2101

*Fabric Required

12702-02 Santa Robe Slice 2 FSA



Size Inches:	Size mm:	Stitch Count:
3.45 X 8.02 in.	87.63 X 203.71 mm	37,674 St.

- 1. Robe Slice 2 Placement Stitch 0015
- 2. Cut Line & Tackdown..... 0015
- 3. White Lace 0015
- 4. Damask Detail 1912
- 5. Red Lace & Cover Stitch 2101

Note: Some designs in this collection may have been created using unique special stitches and/or techniques. To preserve design integrity when rescaling or rotating designs in your software, always rescale or rotate designs using the handles directly on-screen.

***Fabric Required**

12702-03 Santa Robe Slice 3 FSA



Size Inches:	Size mm:	Stitch Count:
3.45 X 8.02 in.	87.63 X 203.71 mm	37,453 St.

- 1. Robe Slice 3 Placement Stitch 0015
- 2. Cut Line & Tackdown..... 0015
- 3. White Lace 0015
- 4. Damask Detail 1912
- 5. Red Lace & Cover Stitch 2101

***Fabric Required**

12702-04 Santa Robe Slice 4 FSA



Size Inches:	Size mm:	Stitch Count:
3.45 X 8.03 in.	87.63 X 203.96 mm	34,461 St.

- 1. Robe Slice 4 Placement Stitch 0015
- 2. Cut Line & Tackdown..... 0015
- 3. White Lace 0015
- 4. Damask Detail 1912
- 5. Red Lace & Cover Stitch 2101

Note: Some designs in this collection may have been created using unique special stitches and/or techniques. To preserve design integrity when rescaling or rotating designs in your software, always rescale or rotate designs using the handles directly on-screen.

***Fabric Required**

12702-05 Santa Arm 1 FSA



Size Inches: 3.03 X 4.45 in. Size mm: 76.96 X 113.03 mm Stitch Count: 17,311 St.

<input type="checkbox"/>	1. Arm 1 Placement Stitch.....	0015
<input type="checkbox"/>	2. Cut Line & Tackdown.....	0015
<input type="checkbox"/>	3. White Lace	0015
<input type="checkbox"/>	4. Charcoal Lace	4174
<input type="checkbox"/>	5. Damask Detail	1912
<input type="checkbox"/>	6. Red Lace & Cover Stitch	2101

***Fabric Required**

12702-06 Santa Arm 2 FSA



Size Inches: 3.03 X 4.45 in. Size mm: 76.96 X 113.03 mm Stitch Count: 17,325 St.

<input type="checkbox"/>	1. Arm 2 Placement Stitch.....	0015
<input type="checkbox"/>	2. Cut Line & Tackdown.....	0015
<input type="checkbox"/>	3. White Lace	0015
<input type="checkbox"/>	4. Charcoal Lace	4174
<input type="checkbox"/>	5. Damask Detail	1912
<input type="checkbox"/>	6. Red Lace & Cover Stitch	2101

Note: Some designs in this collection may have been created using unique special stitches and/or techniques. To preserve design integrity when rescaling or rotating designs in your software, always rescale or rotate designs using the handles directly on-screen.

***Fabric Required**

12702-07 Santa Cape FSA



Size Inches:	Size mm:	Stitch Count:
4.54 X 8.26 in.	115.32 X 209.80 mm	54,510 St.

- 1. Cape Placement Stitch..... 0015
- 2. Cut Line & Tackdown..... 0015
- 3. White Lace 0015
- 4. Damask Detail 1912
- 5. Red Lace & Cover Stitch 2101

***Fabric Required**

12702-08 Santa Foundation FSA

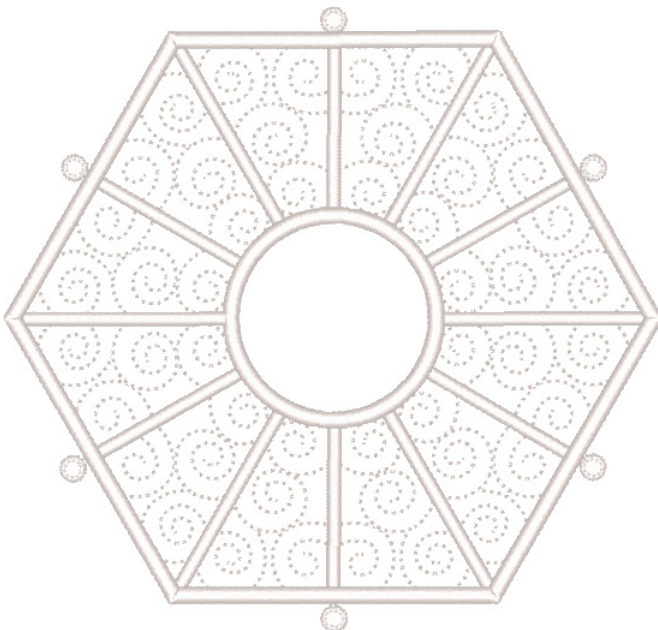

Size Inches:	Size mm:	Stitch Count:
5.72 X 5.42 in.	145.29 X 137.67 mm	16,568 St.

- 1. Foundation Placement Stitch 0015
- 2. Cut Line & Tackdown..... 0015
- 3. White Detail & Cover Stitch 0015

Note: Some designs in this collection may have been created using unique special stitches and/or techniques. To preserve design integrity when rescaling or rotating designs in your software, always rescale or rotate designs using the handles directly on-screen.

12702-09 Santa Beard FSL

Size Inches:	Size mm:	Stitch Count:
4.04 X 4.00 in.	102.62 X 101.60 mm	22,294 St.



- 1. Single Color Design..... 0015

*Fabric Required

12702-10 Santa Face FSA

Size Inches:	Size mm:	Stitch Count:
1.90 X 4.30 in.	48.26 X 109.22 mm	5,484 St.

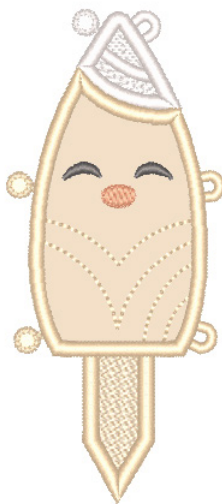

- 1. Face Placement Stitch 0015
- 2. Cut Line & Tackdown..... 0015
- 3. White Lace 0015
- 4. Eyes 4174
- 5. Nose 1430
- 6. Skin Lace & Cover Stitch..... 1060

Note: Some designs in this collection may have been created using unique special stitches and/or techniques. To preserve design integrity when rescaling or rotating designs in your software, always rescale or rotate designs using the handles directly on-screen.

***Fabric Required**

12702-11 Santa Hair & Face 1 FSA

Size Inches:	Size mm:	Stitch Count:
1.89 X 4.32 in.	48.01 X 109.73 mm	9,335 St.

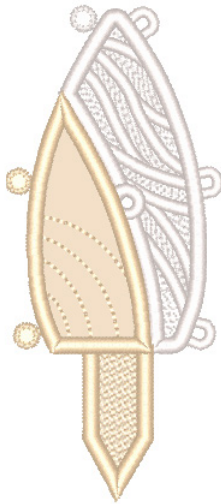

- 1. Face 1 Placement Stitch 0015
- 2. Cut Line & Tackdown..... 0015
- 3. White Lace 0015
- 4. Skin Lace & Cover Stitch..... 1060

***Fabric Required**

12702-12 Santa Hair & Face 2 FSA

Size Inches:	Size mm:	Stitch Count:
1.92 X 4.30 in.	48.77 X 109.22 mm	9,337 St.



- 1. Face 2 Placement Stitch 0015
- 2. Cut Line & Tackdown..... 0015
- 3. White Lace 0015
- 4. Skin Lace & Cover Stitch..... 1060

Note: Some designs in this collection may have been created using unique special stitches and/or techniques. To preserve design integrity when rescaling or rotating designs in your software, always rescale or rotate designs using the handles directly on-screen.

12702-13 Santa Hair FSL

Size Inches: Size mm: Stitch Count:
 1.91 X 4.35 in. 48.51 X 110.49 mm 10,900 St.

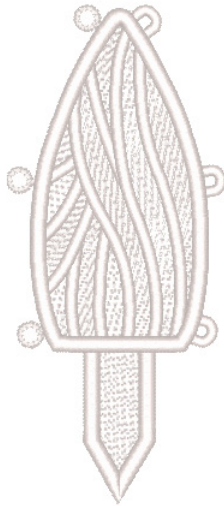

- 1. Single Color Design..... 0015

*Fabric Required

12702-14 Santa Hat FSA

Size Inches: Size mm: Stitch Count:
 5.22 X 6.01 in. 132.59 X 152.65 mm 23,760 St.

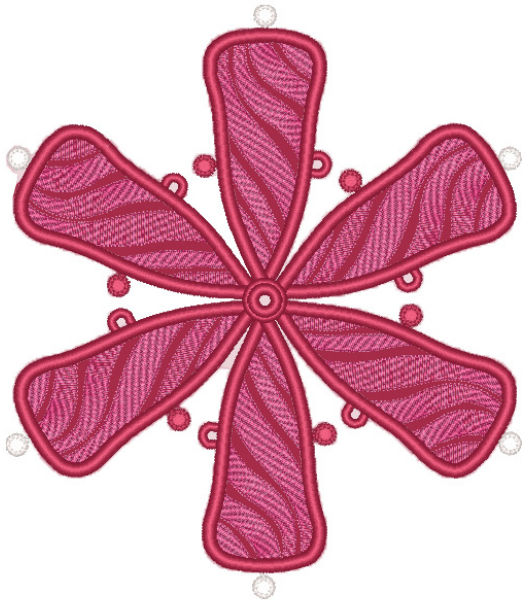

- 1. Hat Placement Stitch..... 2101
- 2. Cut Line & Tackdown..... 2101
- 3. Hat Placement Stitch..... 2101
- 4. Cut Line & Tackdown..... 2101
- 5. Stripes 1912
- 6. White Lace 0015
- 7. Red Lace & Cover Stitch..... 2101

Note: Some designs in this collection may have been created using unique special stitches and/or techniques. To preserve design integrity when rescaling or rotating designs in your software, always rescale or rotate designs using the handles directly on-screen.

12702-15 Santa Hat Ring FSL



Size Inches:	Size mm:	Stitch Count:
1.16 X 9.95 in.	29.46 X 252.73 mm	32,093 St.

1. Single Color Design0015

12702-16 Santa Hat Ball FSL



Size Inches:	Size mm:	Stitch Count:
0.96 X 1.21 in.	24.38 X 30.73 mm	1,956 St.

1. Single Color Design0015

Stabilizers

- OESD AquaMesh WashAway
- OESD BadgeMaster WashAway
- OESD StabilStick CutAway

Fabrics/Textiles

- Red quilter's cotton ¼ yard
- White quilter's cotton (1) 6" x 6"
- Skin Tone quilter's cotton (1) 6" x 6"
- Note: Fabric sizes are estimates and may result in overage.

Notions & Tools

- OESD Alligator Clamps
- OESD Button Clips
- OESD Expert Embroidery Tape WashAway
- OESD Expert Point and Press Tool
- OESD Perfect Embroidery Press Cloth
- Embroidery Needles Sharp 75/11

Isacord Thread Colors

- Per thread chart
- Match the bobbin thread to the upper thread.

SUMMARY



Completed Size: 12"H x 6" W x 6"D

<p>12702-01</p> <p>Requires 1 Design</p> <p>12702-05</p>	<p>12702-02</p> <p>Requires 1 Design</p> <p>12702-06</p>	<p>12702-03</p> <p>Requires 1 Design</p> <p>12702-07</p>	<p>12702-04</p> <p>Requires 3 Design</p> <p>12702-08</p>
<p>12702-09</p> <p>Requires 1 Design</p>	<p>12702-10</p> <p>Requires 1 Design</p>	<p>12702-11</p> <p>Requires 1 Design</p>	<p>12702-12</p> <p>Requires 1 Design</p>
<p>12702-13</p> <p>Requires 1 Design</p>	<p>12702-14</p> <p>Requires 1 Design</p>	<p>12702-15</p> <p>Requires 1 Design</p>	<p>12702-16</p> <p>Requires 1 Design</p>
<p>Requires 3 Designs</p>	<p>12702-17</p> <p>Requires 1 Design</p>	<p>12702-18</p> <p>Requires 1 Design</p>	<p>12702-19</p> <p>Requires 1 Design</p>

Notes

The freestanding applique instructions, included in the collection, are general instructions. For demonstration purposes, a sample design that best demonstrates the technique is shown. Fabric and thread requirements will vary by design, but the general technique is the same.

All designs are stitched with matching thread, top and bobbin.

Note: Some thread colors in instructions have been changed or digitally enhanced for better visibility.

STEP 1

- Hoop one layer of AquaMesh and one layer of BadgeMaster for all designs.



STEP 2

- Adhere two layers of StabilStick CutAway to the wrong side of all applique fabrics, to provide stiffness to the finished structure.

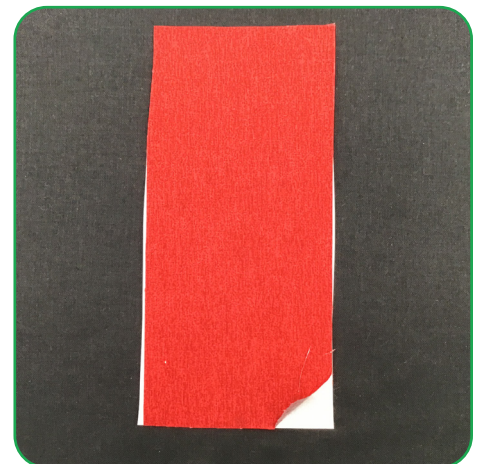

STEP 3

- Load selected design into the machine.
- Example design is 12702-01.
- Thread the machine per the thread chart.
- Place hoop on the machine.
- Stitch Machine Step 1, Robe Slice Placement Stitch.

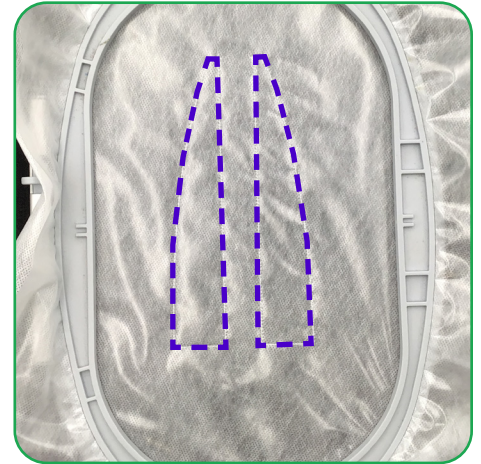

STEP 4

- Remove the hoop from the machine, but NOT the project from the hoop.
- Lay the hoop on a flat surface.
- Place the prepared applique fabric, right side up, completely covering the placement stitch.
- Tape in place to secure.

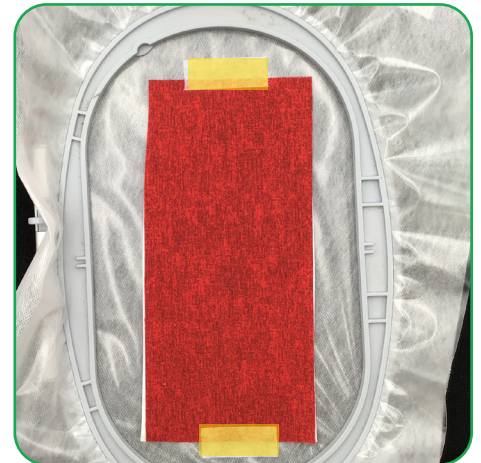

STEP 5

- Place the hoop on the machine.
- Stitch Machine Step 2, Cut Line and Tackdown.

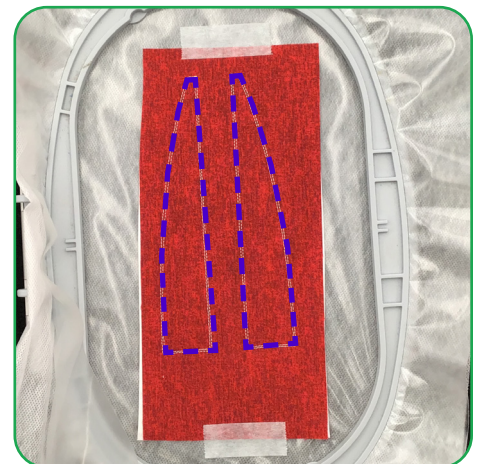

STEP 6

- Remove the hoop from the machine, but NOT the project from the hoop.
- Trim the excess fabric as close to the cut line as possible. If the outermost stitches (cut line) are cut, the inner stitches (tackdown) will hold the applique in place.
- Tip: If the AquaMesh is cut or a hole is created while trimming the fabric, use OESD Expert Embroidery Tape WashAway as a patch.

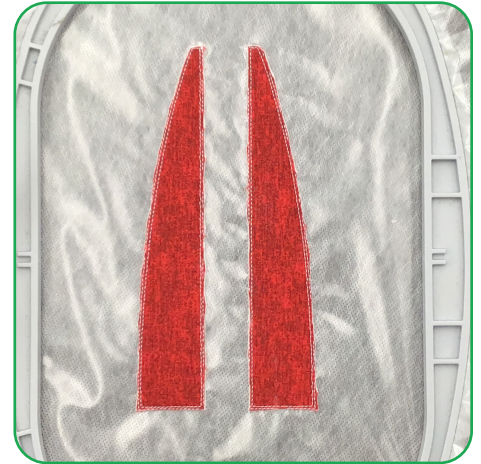

STEP 7

- Return the hoop to the machine and stitch the remaining machine steps, per the thread chart.

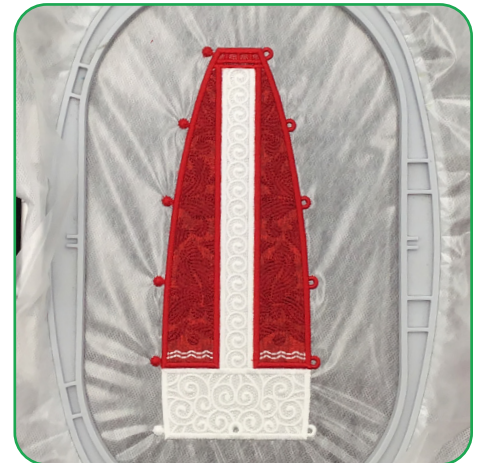

ASSEMBLY



STEP 8

- When the design is complete, remove the project from the hoop and trim the stabilizer 1/4" - 1/2" outside the design.
- Rinse each piece in warm running water until the design is only slightly tacky.
- Lay right side down on a non-stick surface to dry. Parchment paper or a cooling rack work well to prevent curling. Dry completely.
- Once dry, press right side down on a Perfect Embroidery Press Cloth

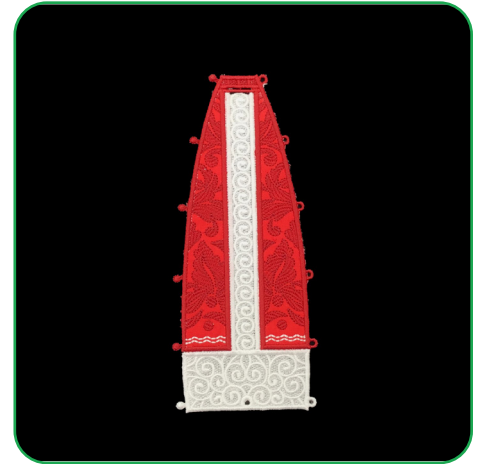

STEP 9

- Lay out the Santa Robe sections as shown starting with Santa Robe Slice 3 FSA (12702-03), Santa Robe Slide 1 FSA (12702-01) Santa Robe Slice 2 FSA (12702-02) and three Santa Robe Slice 4 FSA (12702-04). Match the eyelets to the buttonettes. Pull each buttonette through the corresponding eyelet. Attach a button clip to hold the eyelet in place temporarily when needed.

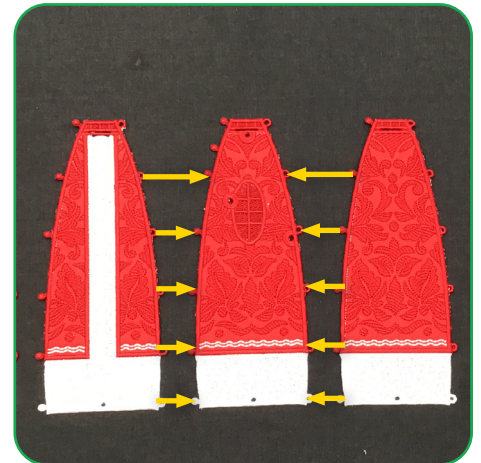

STEP 10

- Attach Santa Arm 1 FSA (12702-05) to Santa Robe Slice 2 FSA (12702-02) Match the three eyelets to the three buttonettes. Pull each buttonette through the corresponding eyelet.

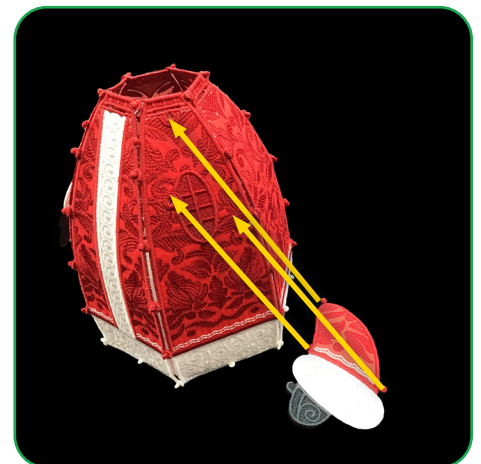

ASSEMBLY



STEP 11

- Continue with the other side. Attach Santa Arm 2 FSA (12702-06) to Santa Robe Slice 2 FSA (12702-03) Match the three eyelets to the three buttonettes. Pull each buttonette through the corresponding eyelet.



STEP 12

- Assemble the Santa Cape FSA (12702-07) into a cape shape. Pull the one buttonette through the corresponding eyelet in the center of the cape.

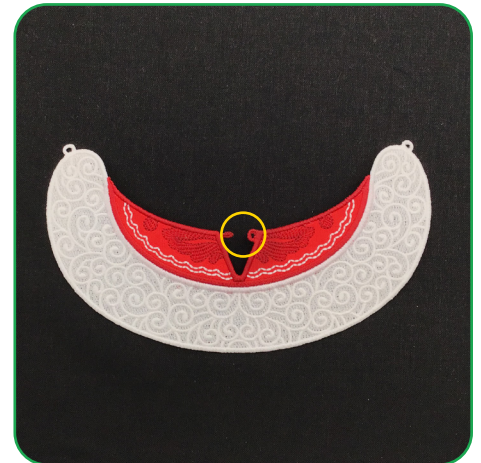

STEP 13

- Wrap Santa Cape FSA (12702-07) around the Santa body. Pull the buttonette located near the top of Santa Robe Slice 3 FSA (12702-03) through the corresponding eyelet on the left of the cape. Attach the right side of the cape eyelet to the buttonette located near the top of Santa Robe Slice 3 FSA (12702-03).



ASSEMBLY



STEP 14

- Lay out the 3 of Santa Hair FSL (12702-13) as shown. Pull each buttonette through the corresponding eyelet.



STEP 15

- Continue with the Santa face. Lay out the Santa Hair & Face 2 FSA (12702-12), Santa Face FSA (12702-10), and Santa Hair and Face 1 FSA (12702-11) as shown. Match the three eyelets to the three buttonettes. Pull each buttonette through the corresponding eyelet.



STEP 16

- Attach the Santa Hair with the Santa face completing the Santa head. Pull each buttonette through the corresponding eyelet.
- Attach the Santa Beard FSL (12702-09) to the assembled Santa head. Pull the side buttonettes of the Santa Beard FSL (12702-09) through the corresponding eyelets of Santa Hair and Face 1 FSA (12702-11) and Santa Hair and Face 2 FSA (12702-12).



STEP 17

- Insert the tabs of the Santa head into the corresponding tab entries of the Santa body.
- Tip: Once all six tabs are halfway inserted, use alligator clamp and pull from inside the Santa body the tabs into the tab entries.
- Note: After putting the tabs into the slots, twist them slightly to help them stay in place, or use Button clips to temporarily hold in place.



STEP 18

- Lay out Santa Hat FSA (12702-14) as shown.
- Attach the red buttonette to the corresponding red eyelet.

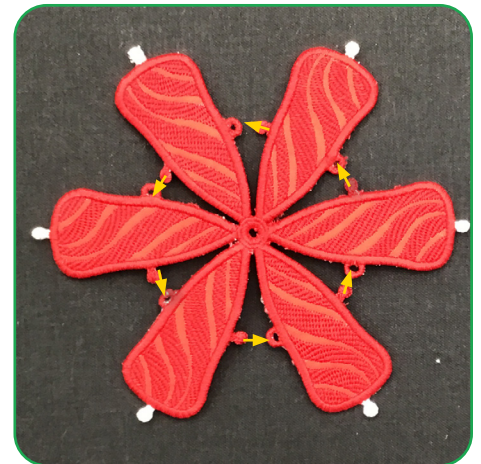

STEP 19

- Assemble the Santa Hat Ring FSL (12702-15) by connecting the two end buttonettes to the two end eyelets.
- Finish Santa Hat assembly by putting the white buttonettes in the Santa Hat FSA (12702-14) into the center eyelets of the Santa Hat Ring FSL (12702-15).

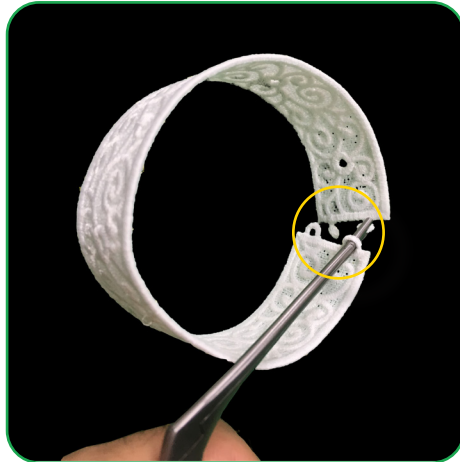

STEP 20

- Pull the buttonette on the Santa Ball Hat FSL (12702-16) inside the top eyelet of the Santa Hat FSA (12702-14).



ASSEMBLY



STEP 21

- Attach the Santa Foundation FSA (12702-08) buttonettes to the Santa body eyelets.

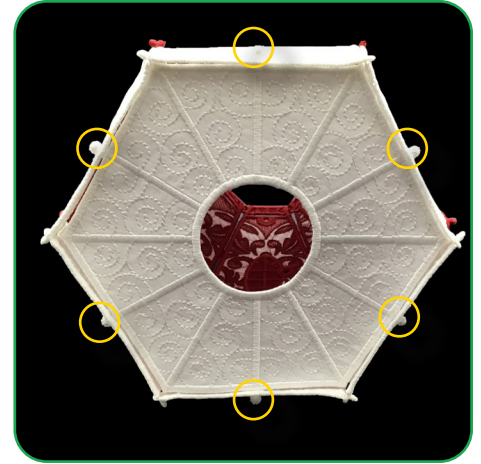

Finishing Touches

- Place Santa Hat on Santa's head.
- Add tea lights or pixie lights to create a glow.



Stabilizer

- OESD AquaMesh
- OESD BadgeMaster

Notions/Tools

- 80/12 Embroidery Ballpoint Titanium needle for extended needle life
- OESD Alligator Clamps
- OESD Button Clips
- OESD Perfect Point and Press Tool

Isacord Thread Colors

- All OESD designs are digitized with Isacord 40 wt. polyester thread as the top thread and in the bobbin.
- Refer to the thread chart for color specifications.
- Match bobbin thread color to the top thread.

Instructions

Step 1 - Hoop

For FSL structures, hoop one layer of OESD AquaMesh and one layer of OESD BadgeMaster. BadgeMaster contains more starch so, combined with the AquaMesh, the lace is more rigid. For other FSL, where a softer lace is desired, hoop two layers of AquaMesh.

Step 2 - Embroider

Stitch the design per the thread chart with matching thread in the bobbin at each color change. When complete, remove from the hoop and trim away excess stabilizer about 1/4"-1/2" from the stitching.

Step 3 - Rinse

Rinse remaining stabilizer out in warm running water. For stiffer lace and FSL structures, DO NOT rinse away all of the stabilizer. The lace should be just slightly tacky. For softer lace, rinse until all traces of the stabilizer are removed.

Step 4 - Dry

Lay right side down flat on a non-stick surface, such as a cooling rack, parchment paper or Teflon sheet. This minimizes the tendency for the lace to curl. Let the pieces dry completely before proceeding with any assembly.

Step 5 - Press

Once completely dry, press right side down on a OESD Perfect Embroidery Press Cloth.

Step 6 - Assemble Structure

Note: Specific assembly instructions for a design/collection may be found in the thread chart pdf following the individual design color charts.

Lace must be COMPLETELY DRY before assembly. Wetting the buttonettes or eyelets to assemble is not recommended and may result in them stretching and coming "unbuttoned" when dry.

Use a pair of OESD Alligator Clamps to insert the buttonettes into the eyelets. Insert the tip of the OESD Alligator Clamps into the eyelet, grasp the buttonette and pull through the eyelet. Alternatively, use a stiletto or tweezers to push the buttonette through the eyelet.

Helpful Tips

Limp Lace

If the design is not stiff enough, press the lace pieces on the wrong side while applying spray starch. After ironing, spray again with starch and allow to dry completely. This will stiffen the lace pieces nicely and aid in construction. Or easily re-stiffen by diluting some stabilizer scraps in water (or use liquid starch) and dipping the item in the solution. Lay flat to dry.

Eyelets Too Small

If any of the eyelets appear closed or too small to penetrate with Alligator Clamps, they may be stretched by inserting the small end of the OESD Perfect Point and Press Tool into the eyelet opening and stretching it open wide enough to accommodate the OESD Alligator Clamps.

Button Clips

During the assembly process, some structures pull on buttonettes that have already been inserted and could pull them out altogether. Putting a Button Clip on the assembled buttonette will keep it in position during the assembly process. Remove the Button Clips when the assembly is complete.

Alternative Construction Option

In some cases, the buttonettes may be pulled to the inside of a project, instead of being visible on the outside. Insert the OESD Alligator Clamps through the eyelet from the wrong, or inside, of the lace and grasp the corresponding buttonette. Pull the buttonette to the wrong side of the lace.

Pulling the buttonettes to the inside may cause stress on the ones already done. Button clips may be placed on the completed buttonette(s) to prevent them from pulling out of the eyelet during construction.

ATTENTION

When printing this document, any page scaling or page fitting options in your print dialog box must be turned OFF or set to NONE so that your files will print out at their actual size. Images not printed at actual size will not function as intended.

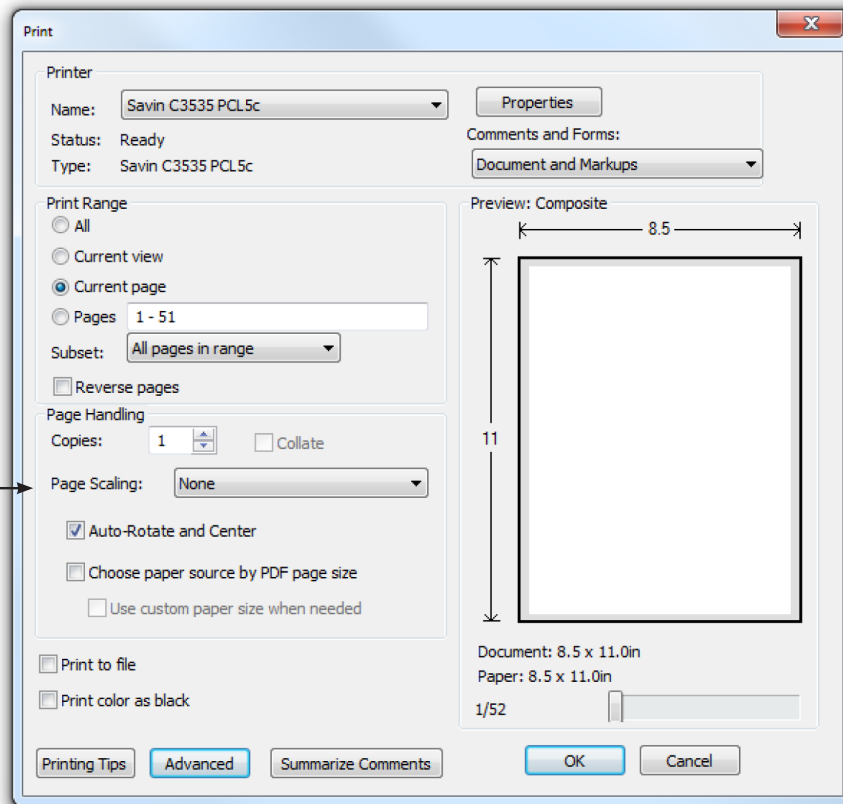

TO SAVE PAPER

Only print the desired image by navigating to the image's page, go to File > Print and select "Current page" in the print dialog box. Repeat for each desired image.

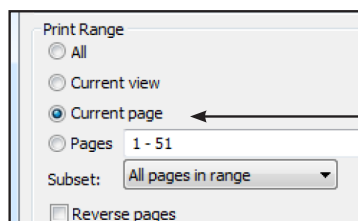

APPLIQUE PATTERNS



Print at 100%. No scaling. This box measures 1" x 1". Use the box as an accuracy guide when printing templates.

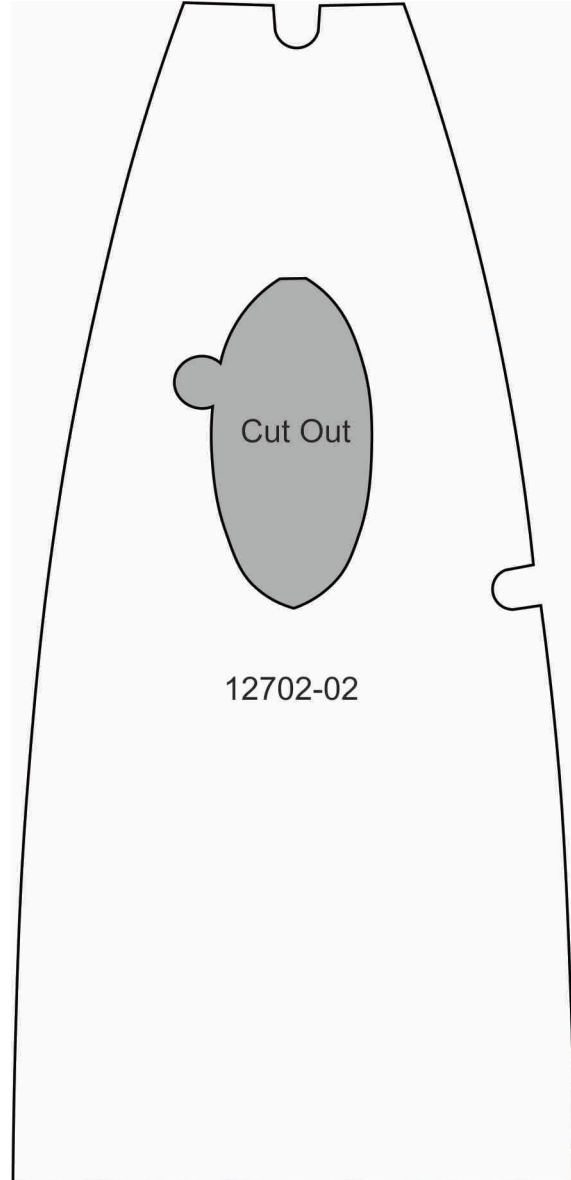
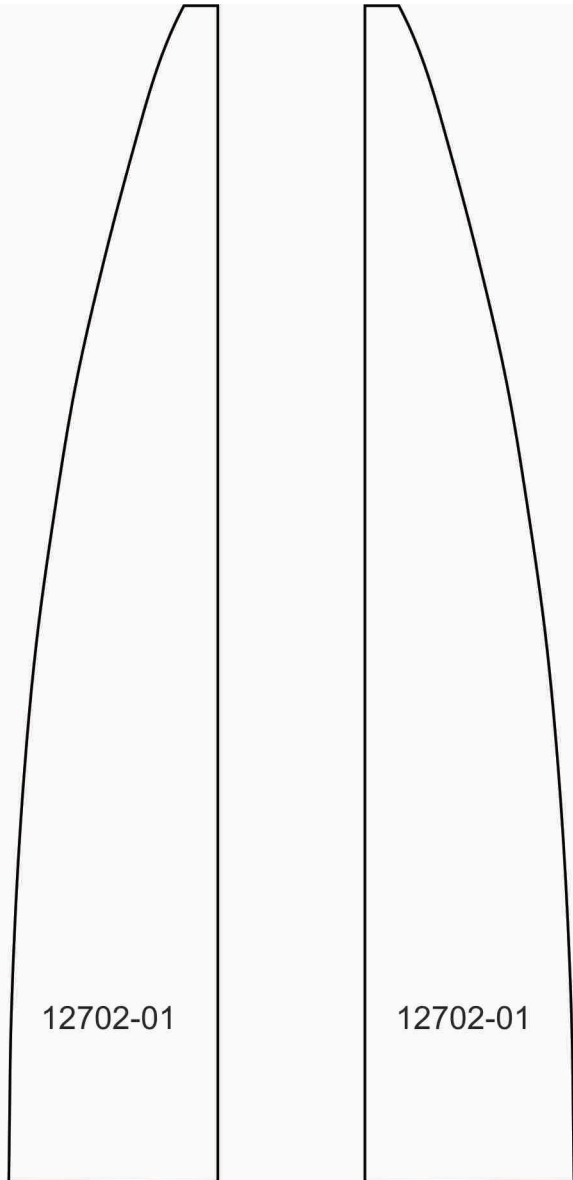

APPLIQUE PATTERNS



Print at 100%. No scaling. This box measures 1" x 1". Use the box as an accuracy guide when printing templates.

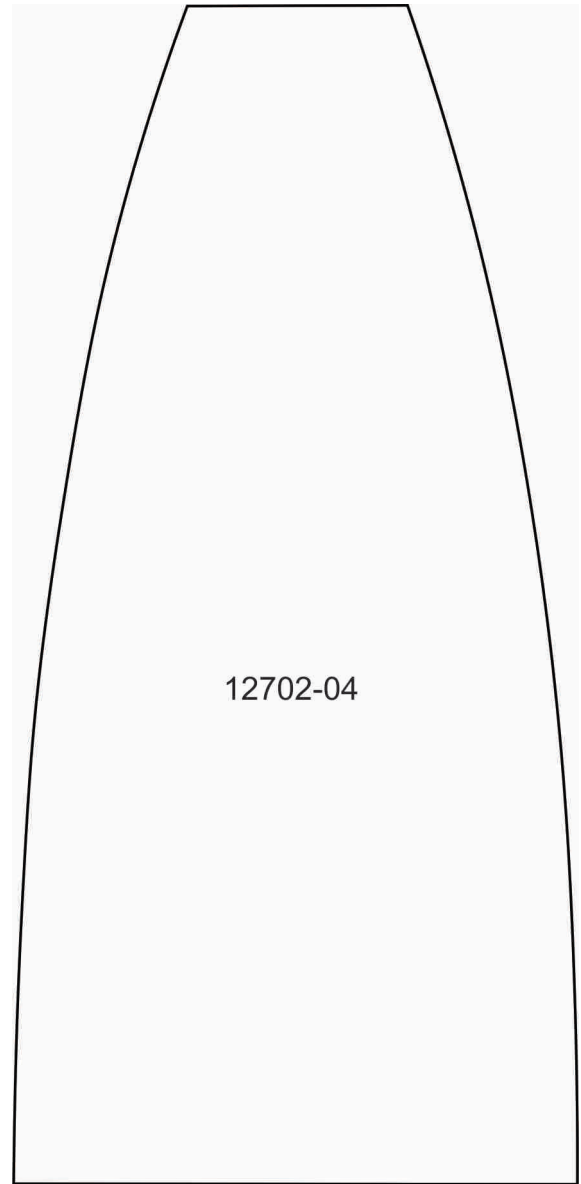
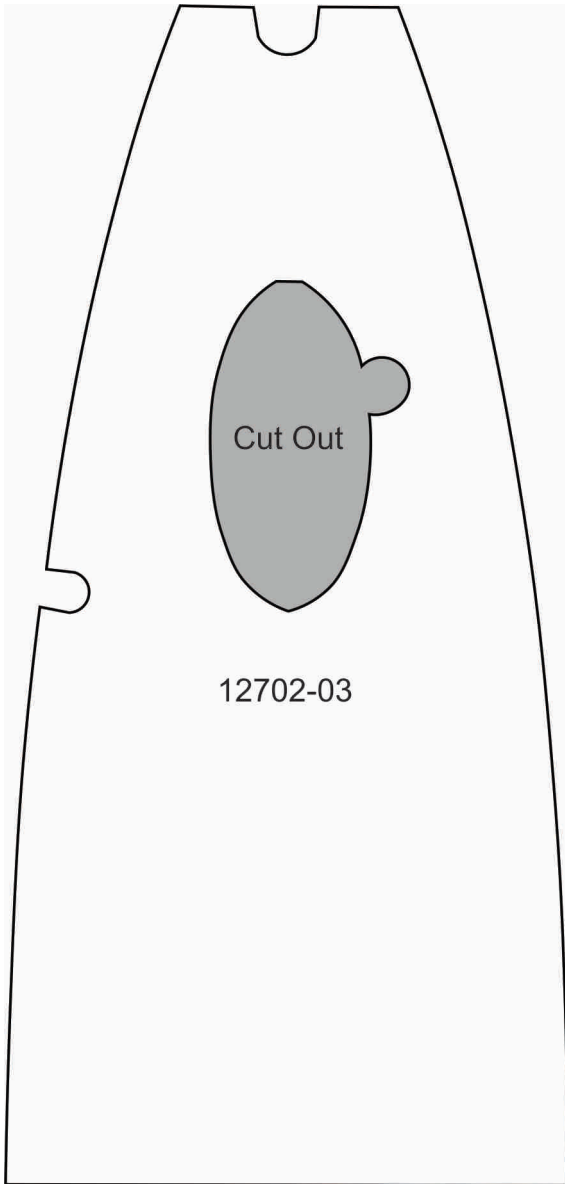

APPLIQUE PATTERNS



Print at 100%. No scaling. This box measures 1" x 1". Use the box as an accuracy guide when printing templates.

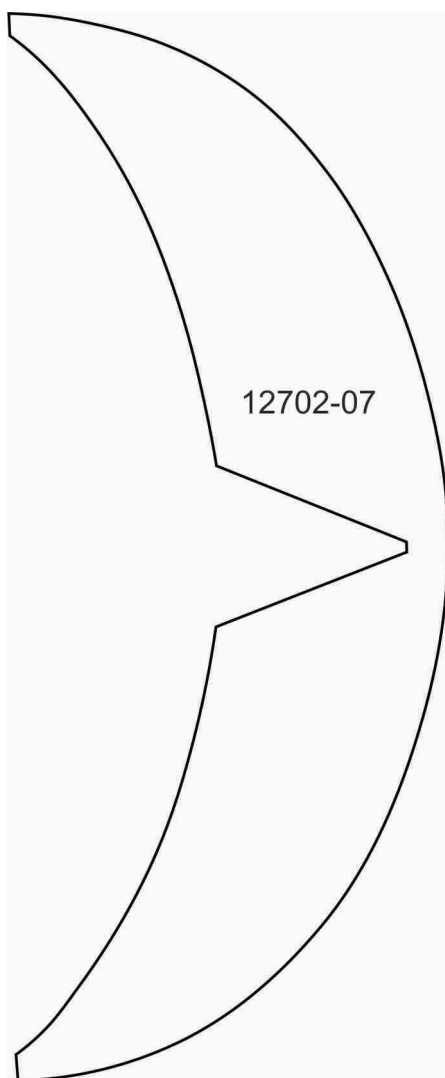
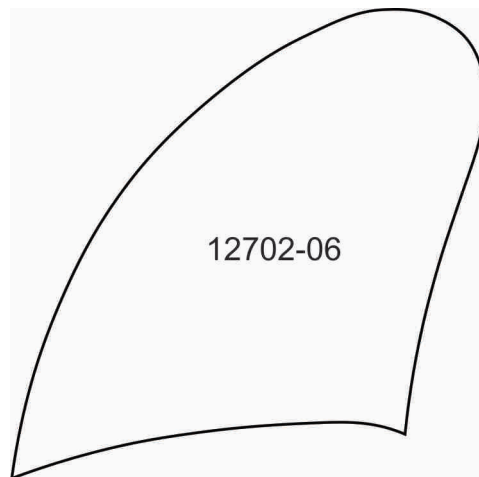
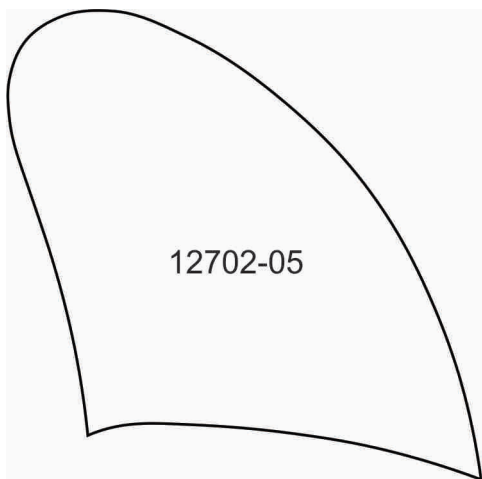

APPLIQUE PATTERNS



Print at 100%. No scaling. This box measures 1" x 1". Use the box as an accuracy guide when printing templates.

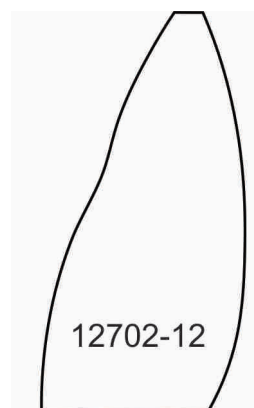
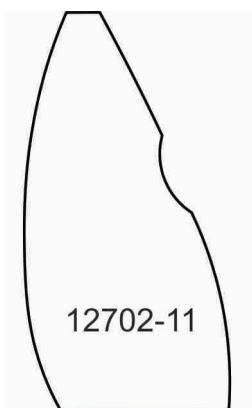
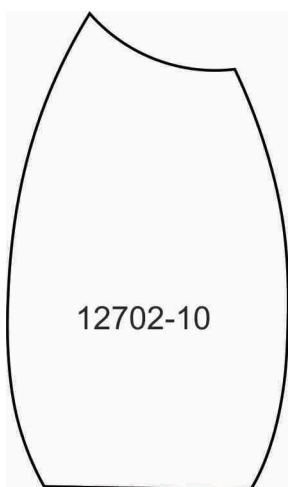
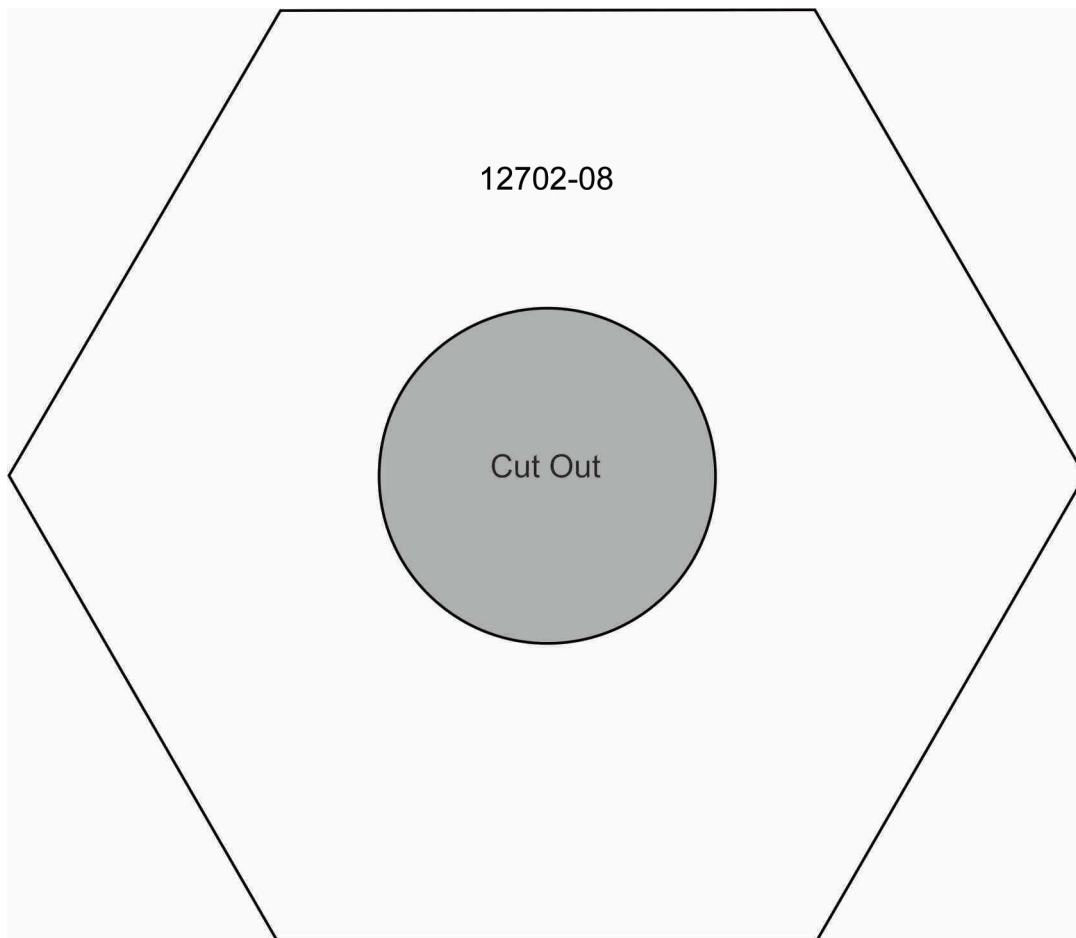

APPLIQUE PATTERNS



Print at 100%. No scaling. This box measures 1" x 1". Use the box as an accuracy guide when printing templates.

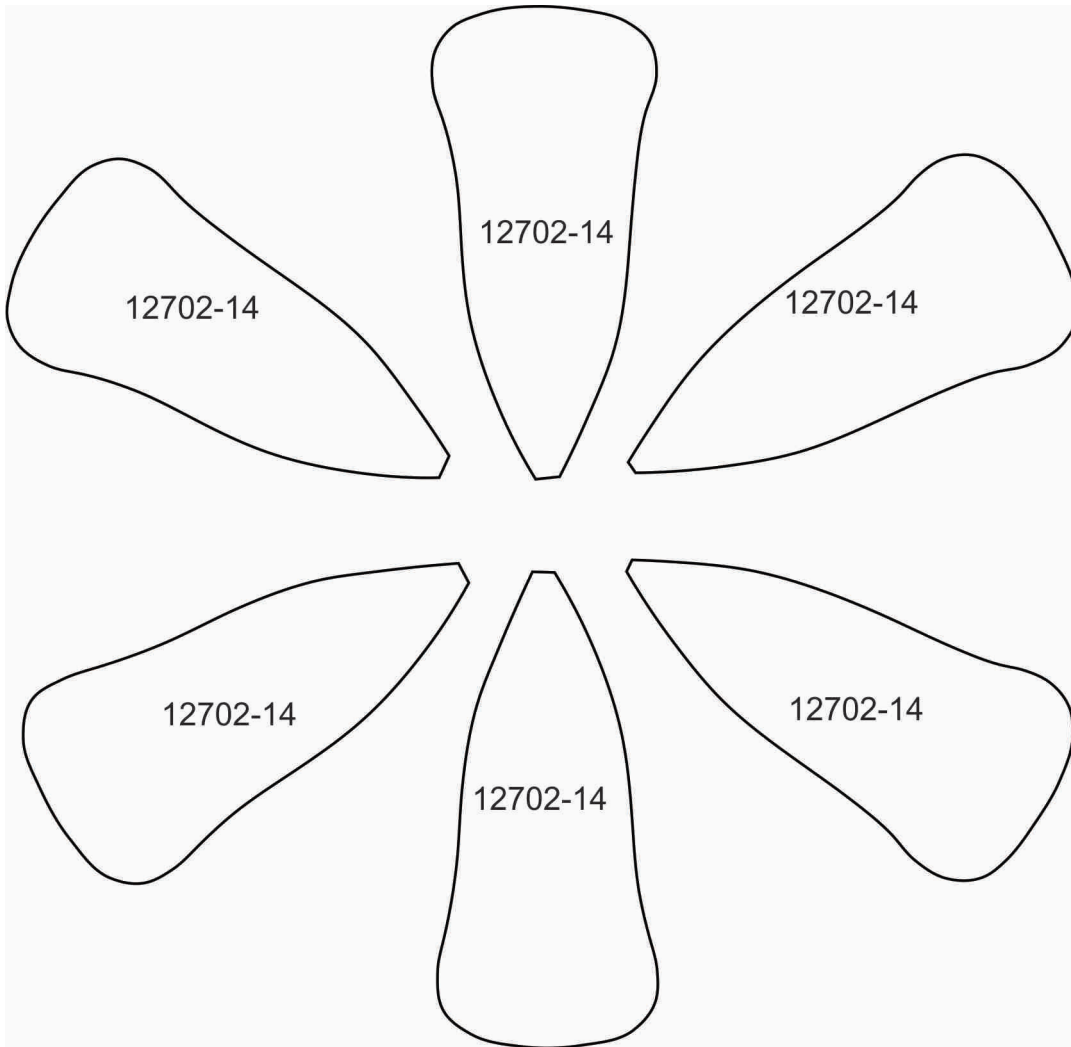

MIRRORED PATTERNS



Print at 100%. No scaling. This box measures 1" x 1". Use the box as an accuracy guide when printing templates.

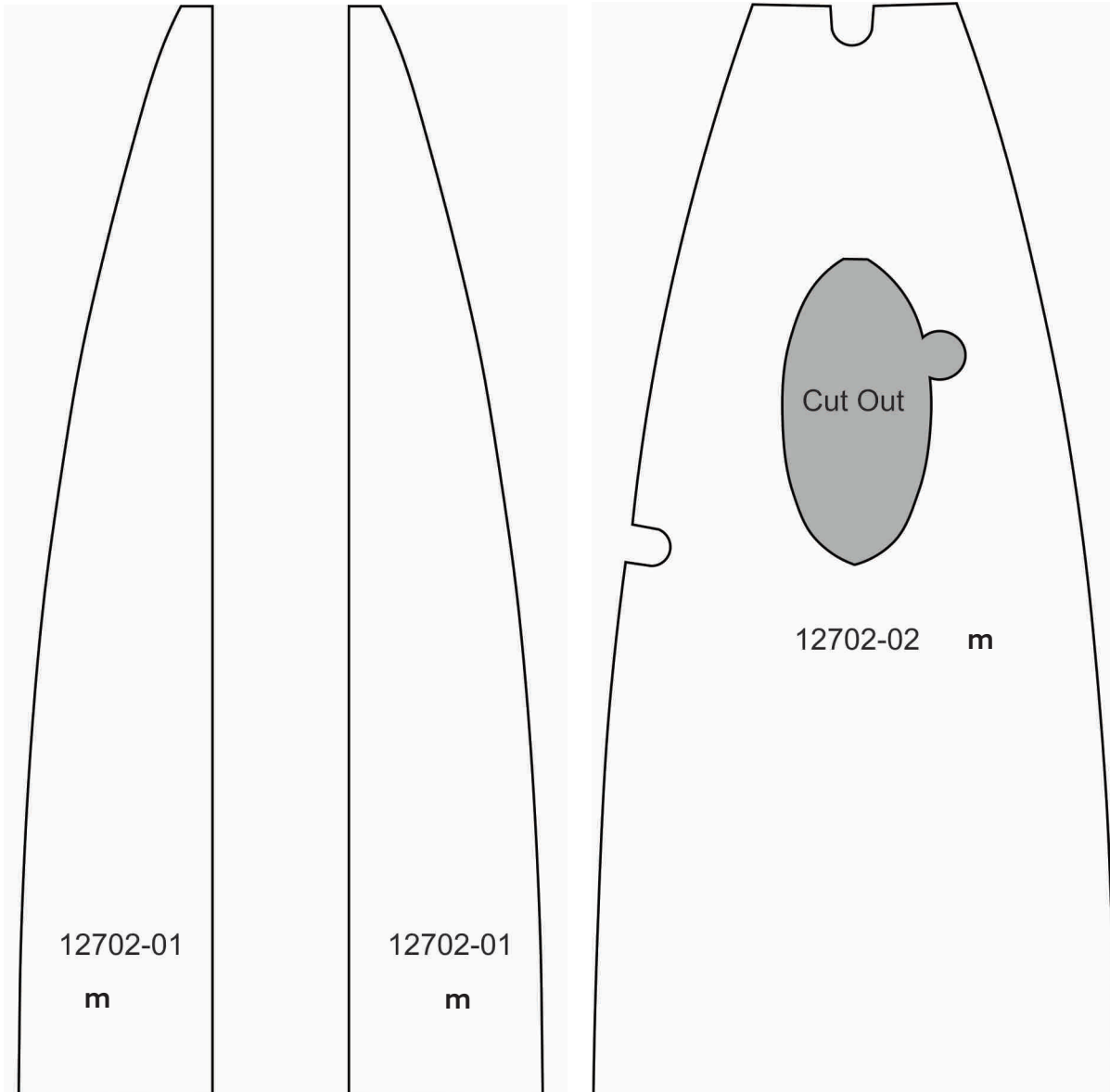

MIRRORED PATTERNS



Print at 100%. No scaling. This box measures 1" x 1". Use the box as an accuracy guide when printing templates.

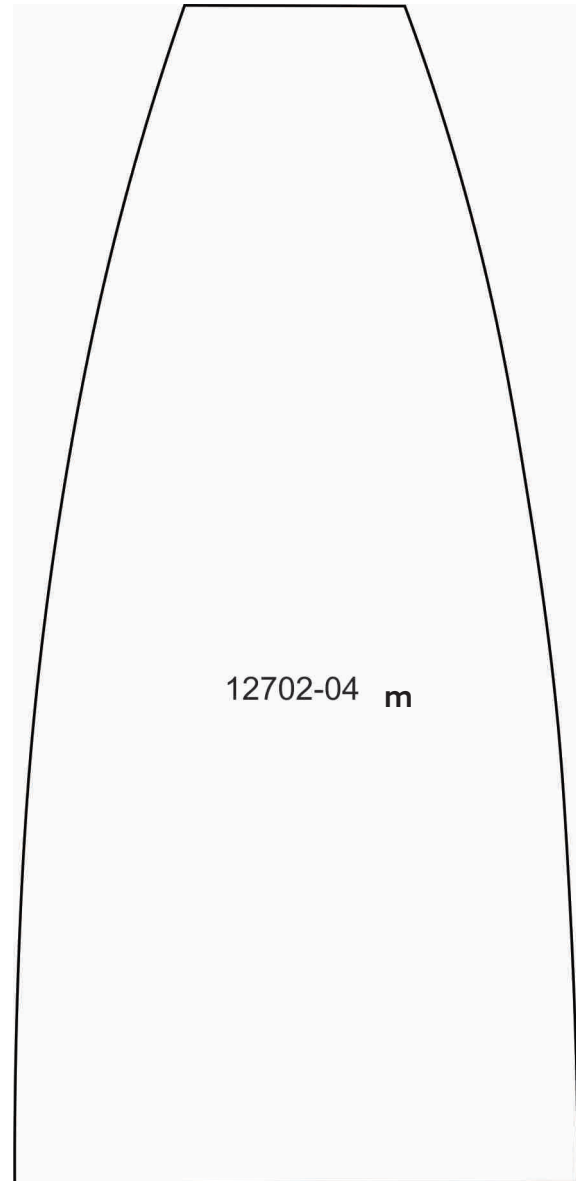
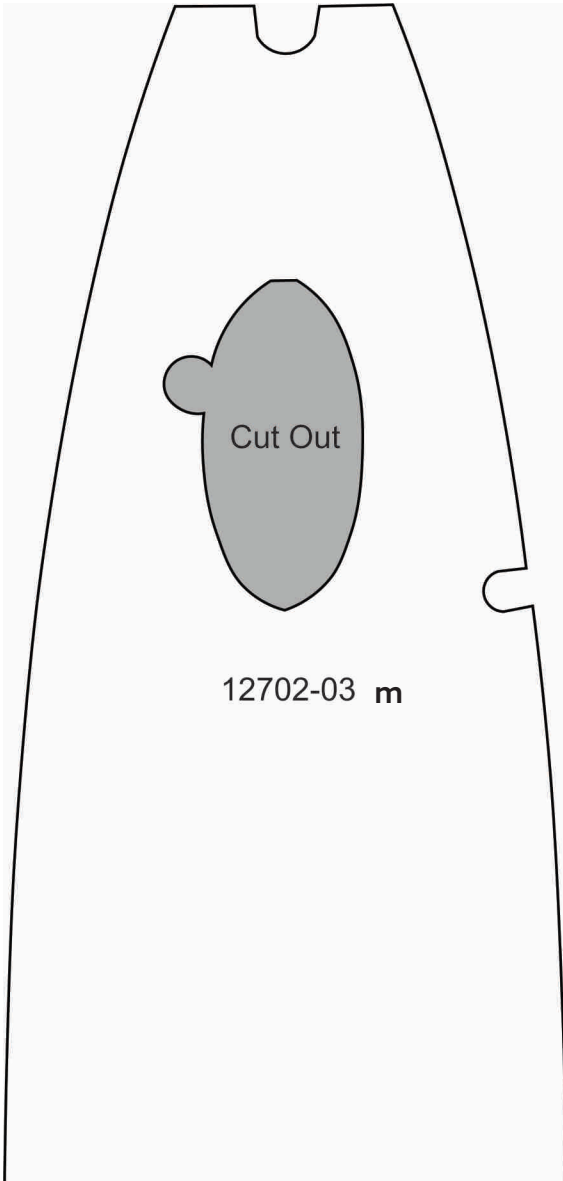

MIRRORED PATTERNS



Print at 100%. No scaling. This box measures 1" x 1". Use the box as an accuracy guide when printing templates.

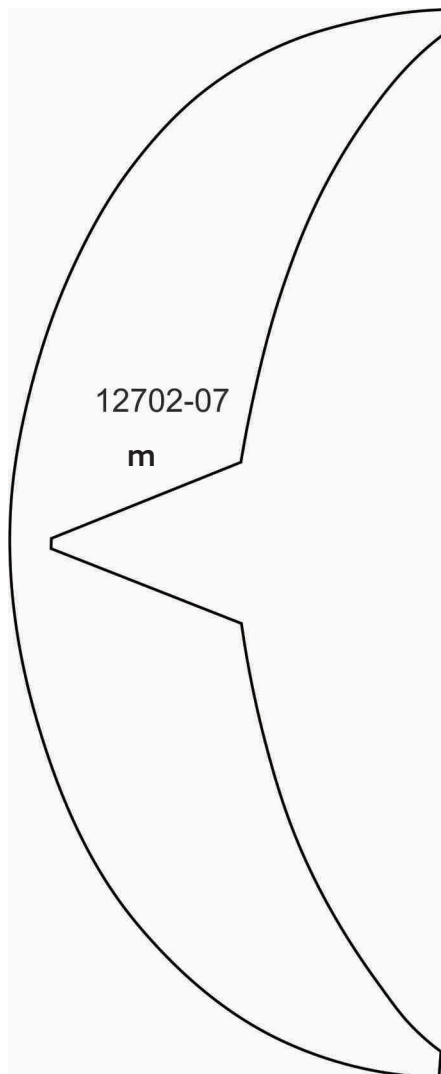
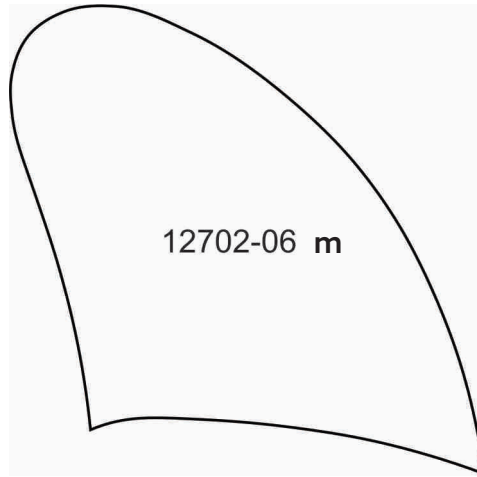
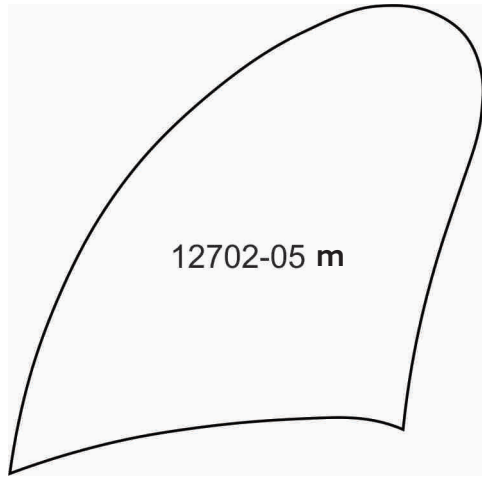

MIRRORED PATTERNS



Print at 100%. No scaling. This box measures 1" x 1". Use the box as an accuracy guide when printing templates.

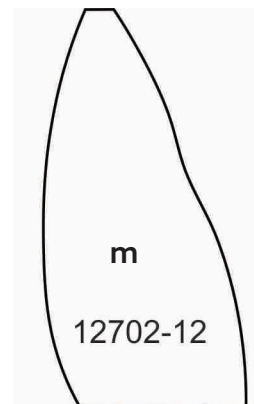
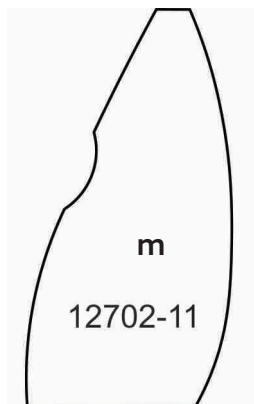
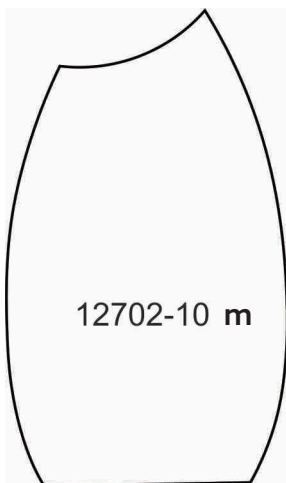
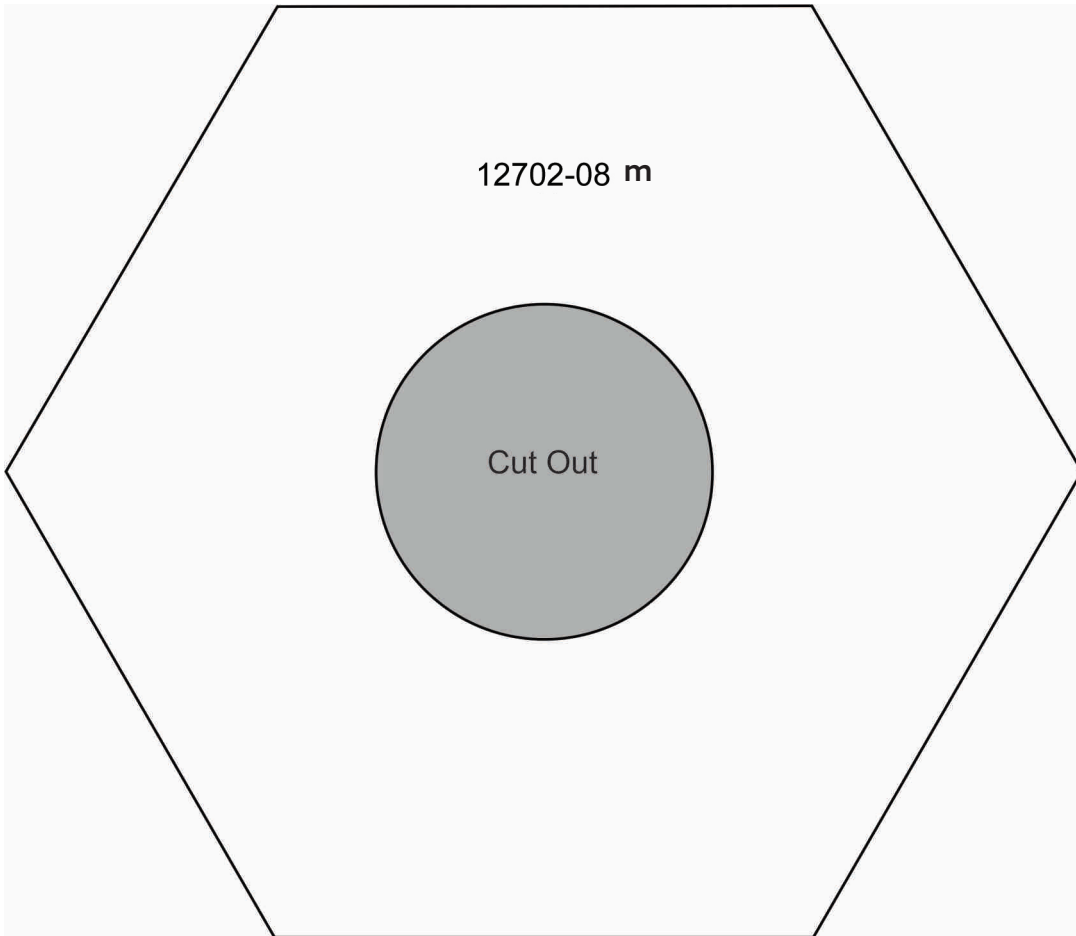

MIRRORED PATTERNS



Print at 100%. No scaling. This box measures 1" x 1". Use the box as an accuracy guide when printing templates.

