

#12736



18
DESIGNS

Pieced to Perfection: Purple Stars

Note: Some designs in this collection may have been created using unique special stitches and/or techniques. To preserve design integrity when rescaling or rotating designs in your software, always rescale or rotate designs using the handles directly on-screen.

12736-01 Purple Star 1

Size Inches: Size mm: Stitch Count:
5.51 X 5.51 in. 139.95 X 139.95 mm 1,726 St.



12736-01 Purple Star 1

- 1. Design Placement Guide and Placement Guide 1 0020
- 2. Placement Guide 2 0020
- 3. Tackdown and Fold Line 2 0020
- 4. Placement Guide 3 0020
- 5. Tackdown and Fold Line 3 0020
- 6. Placement Guide 4 0020
- 7. Tackdown and Fold Line 4 0020
- 8. Placement Guide 5 0020
- 9. Tackdown and Fold Line 5 0020
- 10. Placement Guide 6 0020
- 11. Tackdown and Fold Line 6 0020
- 12. Stay Stitch 0020

12736-02 Purple Star 2

Size Inches: Size mm: Stitch Count:
5.50 X 5.50 in. 139.70 X 139.70 mm 1,557 St.

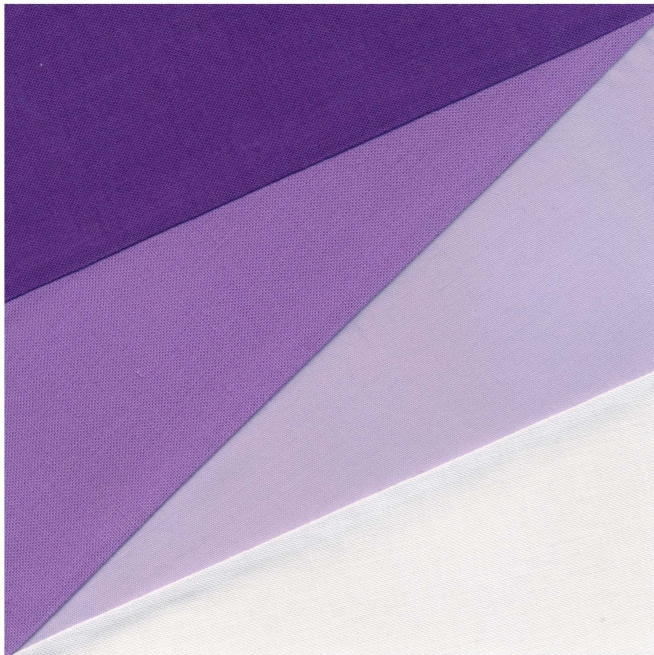

- 1. Design Placement Guide and Placement Guide 1 0020
- 2. Placement Guide 2 0020
- 3. Tackdown and Fold Line 2 0020
- 4. Placement Guide 3 0020
- 5. Tackdown and Fold Line 3 0020
- 6. Placement Guide 4 0020
- 7. Tackdown and Fold Line 4 0020
- 8. Stay Stitch 0020

Note: Some designs in this collection may have been created using unique special stitches and/or techniques. To preserve design integrity when rescaling or rotating designs in your software, always rescale or rotate designs using the handles directly on-screen.

12736-03 Purple Star 3

Size Inches: Size mm: Stitch Count:
5.51 X 5.50 in. 139.95 X 139.70 mm 1,867 St.



- 1. Design Placement Guide and Placement
 Guide 1 0020
- 2. Placement Guide 2 0020
- 3. Tackdown and Fold Line 2 0020
- 4. Placement Guide 3 0020
- 5. Tackdown and Fold Line 3 0020
- 6. Placement Guide 4 0020
- 7. Tackdown and Fold Line 4 0020
- 8. Placement Guide 5 0020
- 9. Tackdown and Fold Line 5 0020
- 10. Placement Guide 6 0020
- 11. Tackdown and Fold Line 6 0020
- 12. Stay Stitch 0020

12736-04 Purple Star 4

Size Inches: Size mm: Stitch Count:
5.50 X 5.51 in. 139.70 X 139.95 mm 1,948 St.



- 1. Design Placement Guide and Placement
 Guide 1 0020
- 2. Placement Guide 2 0020
- 3. Tackdown and Fold Line 2 0020
- 4. Placement Guide 3 0020
- 5. Tackdown and Fold Line 3 0020
- 6. Placement Guide 4 0020
- 7. Tackdown and Fold Line 4 0020
- 8. Placement Guide 5 0020
- 9. Tackdown and Fold Line 5 0020
- 10. Placement Guide 6 0020
- 11. Tackdown and Fold Line 6 0020
- 12. Stay Stitch 0020

Note: Some designs in this collection may have been created using unique special stitches and/or techniques. To preserve design integrity when rescaling or rotating designs in your software, always rescale or rotate designs using the handles directly on-screen.

12736-05 Purple Star 5

Size Inches: Size mm: Stitch Count:
5.50 X 5.35 in. 139.70 X 135.89 mm 1,390 St.



- 1. Design Placement Guide and Placement
 Guide 1 0020
- 2. Placement Guide 2 0020
- 3. Tackdown and Fold Line 2 0020
- 4. Placement Guide 3 0020
- 5. Tackdown and Fold Line 3 0020
- 6. Placement Guide 4 0020
- 7. Tackdown and Fold Line 4 0020
- 8. Stay Stitch 0020

12736-06 Purple Star 6

Size Inches: Size mm: Stitch Count:
5.50 X 5.50 in. 139.70 X 139.70 mm 1,671 St.



- 1. Design Placement Guide and Placement
 Guide 1 0020
- 2. Placement Guide 2 0020
- 3. Tackdown and Fold Line 2 0020
- 4. Placement Guide 3 0020
- 5. Tackdown and Fold Line 3 0020
- 6. Placement Guide 4 0020
- 7. Tackdown and Fold Line 4 0020
- 8. Placement Guide 5 0020
- 9. Tackdown and Fold Line 5 0020
- 10. Stay Stitch 0020

Note: Some designs in this collection may have been created using unique special stitches and/or techniques. To preserve design integrity when rescaling or rotating designs in your software, always rescale or rotate designs using the handles directly on-screen.

12736-07 Purple Star 7

Size Inches: Size mm: Stitch Count:
5.50 X 5.50 in. 139.70 X 139.70 mm 1,978 St.



- 1. Design Placement Guide and Placement
 Guide 1 0020
- 2. Placement Guide 2 0020
- 3. Tackdown and Fold Line 2 0020
- 4. Placement Guide 3 0020
- 5. Tackdown and Fold Line 3 0020
- 6. Placement Guide 4 0020
- 7. Tackdown and Fold Line 4 0020
- 8. Placement Guide 5 0020
- 9. Tackdown and Fold Line 5 0020
- 10. Placement Guide 6 0020
- 11. Tackdown and Fold Line 6 0020
- 12. Placement Guide 7 0020
- 13. Tackdown and Fold Line 7 0020
- 14. Stay Stitch 0020

12736-08 Purple Star 8

Size Inches: Size mm: Stitch Count:
5.34 X 5.50 in. 135.64 X 139.70 mm 1,483 St.

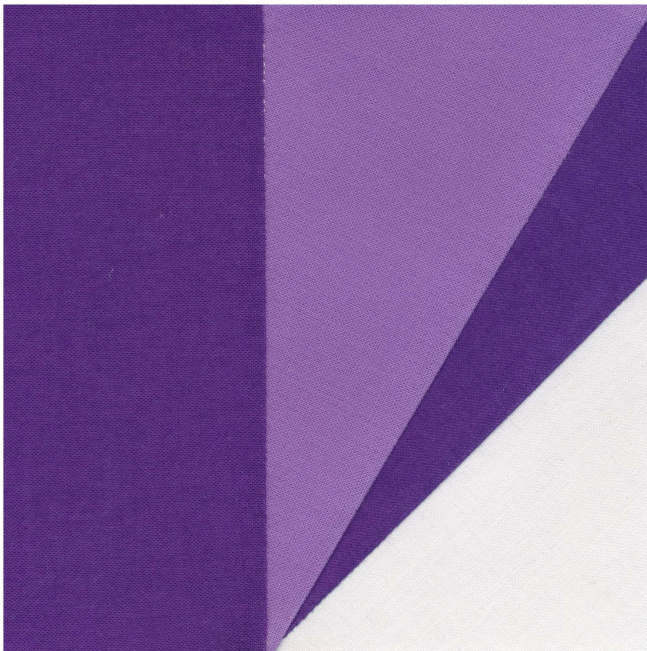

- 1. Design Placement Guide and Placement
 Guide 1 0020
- 2. Placement Guide 2 0020
- 3. Tackdown and Fold Line 2 0020
- 4. Placement Guide 3 0020
- 5. Tackdown and Fold Line 3 0020
- 6. Placement Guide 4 0020
- 7. Tackdown and Fold Line 4 0020
- 8. Stay Stitch 0020

Note: Some designs in this collection may have been created using unique special stitches and/or techniques. To preserve design integrity when rescaling or rotating designs in your software, always rescale or rotate designs using the handles directly on-screen.

12736-09 Purple Star 9

Size Inches: Size mm: Stitch Count:
5.50 X 5.50 in. 139.70 X 139.70 mm 1,712 St.



- 1. Design Placement Guide 1 and Placement Guide 1 0020
- 2. Placement Guide 2 0020
- 3. Tackdown and Fold Line 2 0020
- 4. Placement Guide 3 0020
- 5. Tackdown and Fold Line 3 0020
- 6. Placement Guide 4 0020
- 7. Tackdown and Fold Line 4 0020
- 8. Placement Guide 5 0020
- 9. Tackdown and Fold Line 5 0020
- 10. Stay Stitch 0020

12736-10 Purple Star Quilt Motif 1

Size Inches: Size mm: Stitch Count:
5.41 X 5.41 in. 137.41 X 137.41 mm 1,254 St.

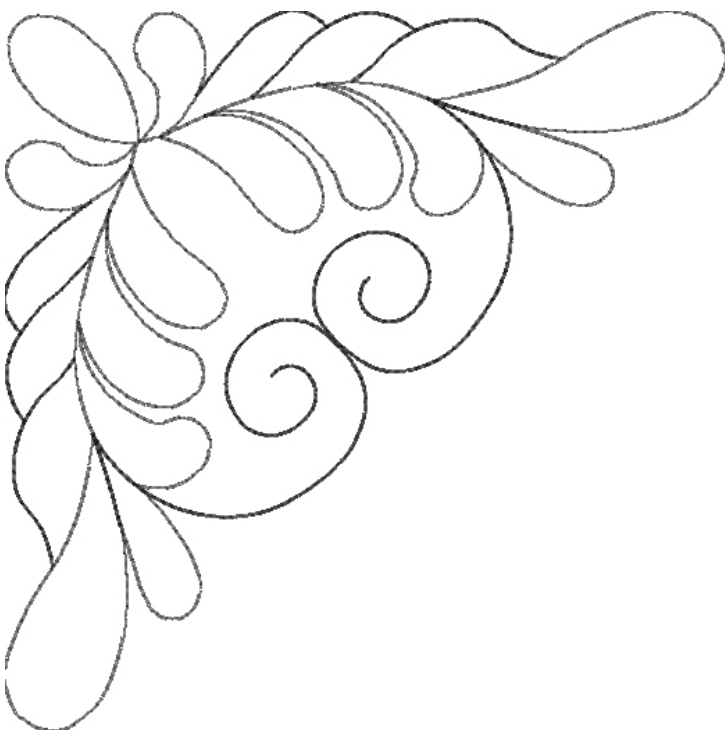

- 1. Single Color Design 0020

Note: Some designs in this collection may have been created using unique special stitches and/or techniques. To preserve design integrity when rescaling or rotating designs in your software, always rescale or rotate designs using the handles directly on-screen.

12736-11 Purple Star Quilt Motif 2

Size Inches:	Size mm:	Stitch Count:
6.00 X 6.00 in.	152.40 X 152.40 mm	1,193 St.

■ 1. Single Color Design..... 0020

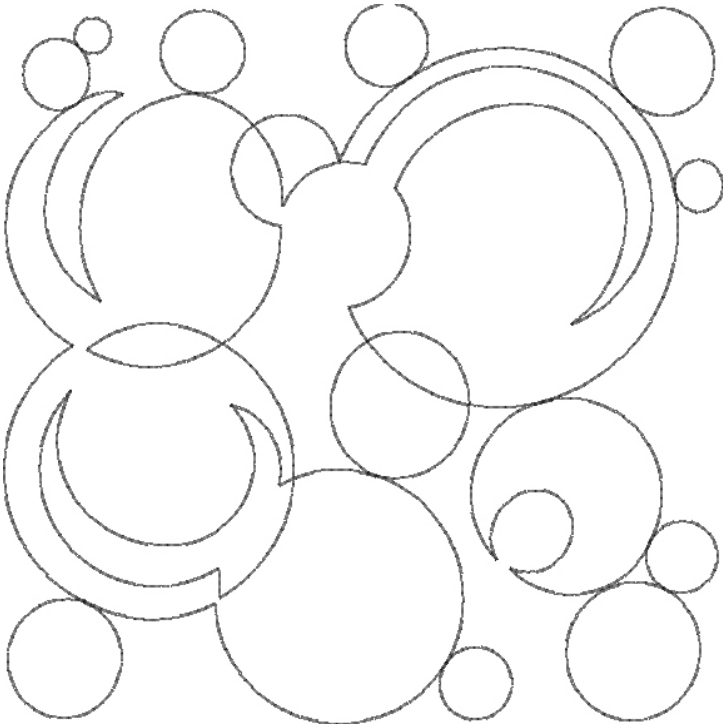

12736-12 Purple Star Quilt Motif 3

Size Inches:	Size mm:	Stitch Count:
5.00 X 5.00 in.	127.00 X 127.00 mm	976 St.

■ 1. Single Color Design..... 0020

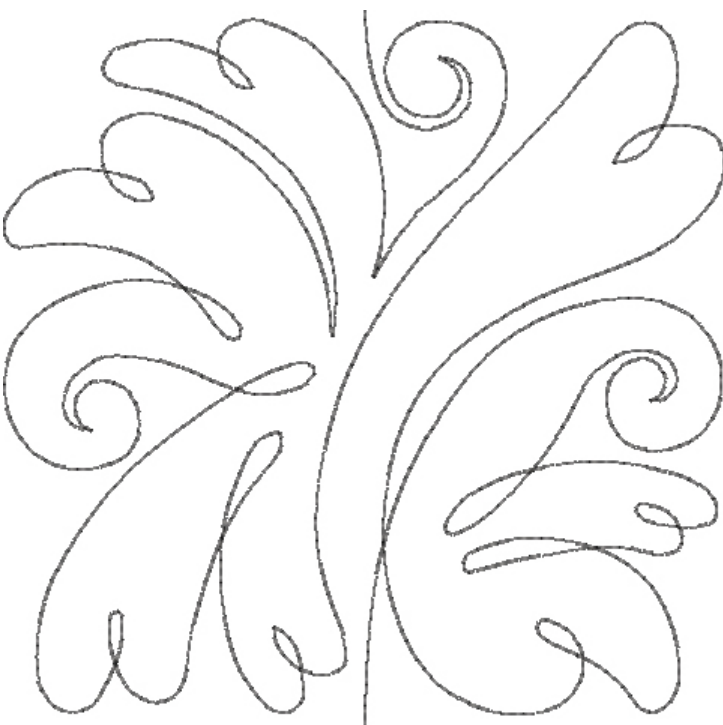

Note: Some designs in this collection may have been created using unique special stitches and/or techniques. To preserve design integrity when rescaling or rotating designs in your software, always rescale or rotate designs using the handles directly on-screen.

12736-13 Purple Star Quilt Motif 4

Size Inches: Size mm: Stitch Count:
6.00 X 6.00 in. 152.40 X 152.40 mm 890 St.

■ 1. Single Color Design..... 0020

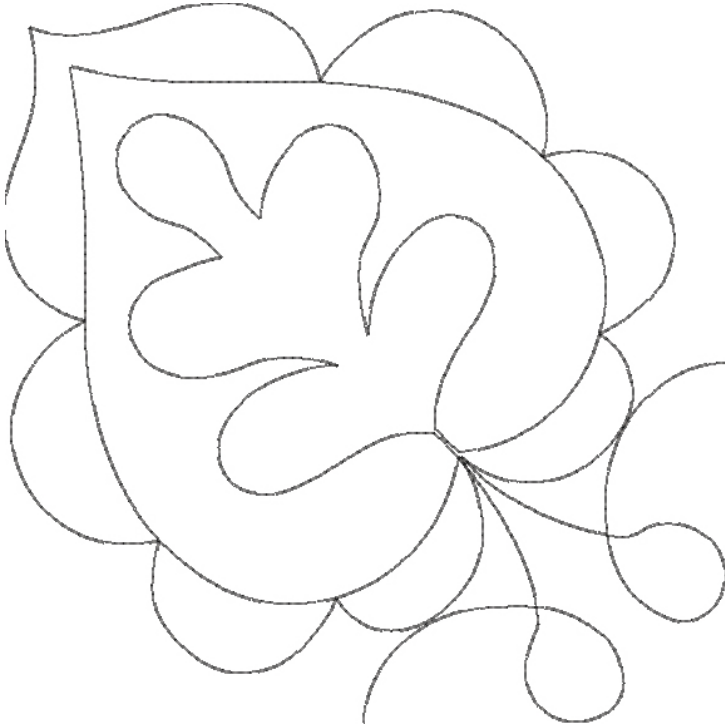

12736-14 Purple Star Quilt Motif 5

Size Inches: Size mm: Stitch Count:
4.95 X 4.95 in. 125.73 X 125.73 mm 663 St.

■ 1. Single Color Design..... 0020

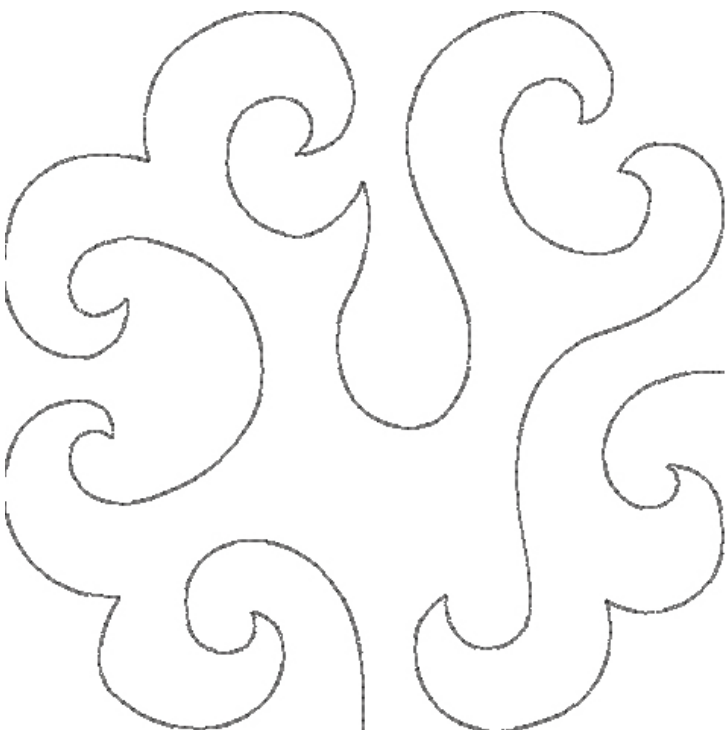

Note: Some designs in this collection may have been created using unique special stitches and/or techniques. To preserve design integrity when rescaling or rotating designs in your software, always rescale or rotate designs using the handles directly on-screen.

12736-15 Purple Star Quilt Motif 6

Size Inches:	Size mm:	Stitch Count:
5.00 X 4.96 in.	127.00 X 125.98 mm	738 St.

■ 1. Single Color Design..... 0020

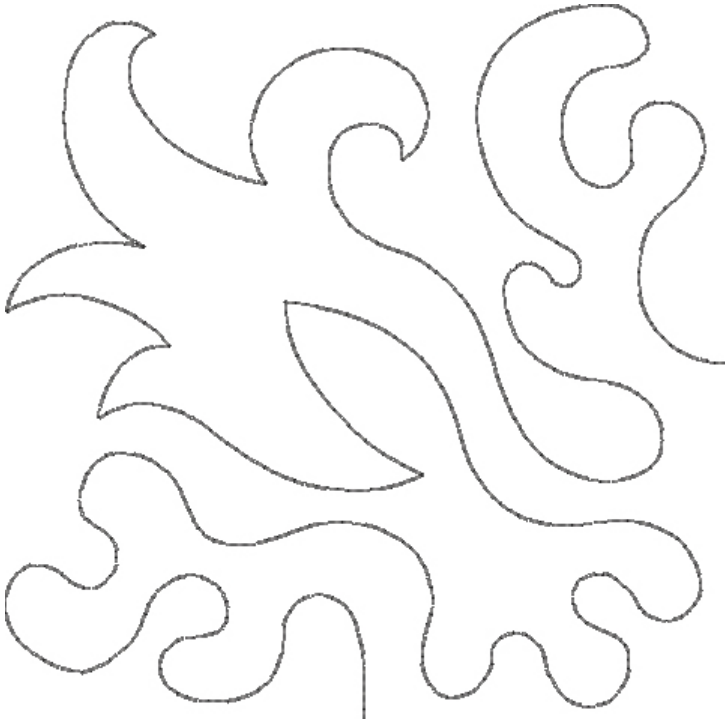

12736-16 Purple Star Quilt Motif 7

Size Inches:	Size mm:	Stitch Count:
5.00 X 4.99 in.	127.00 X 126.75 mm	726 St.

■ 1. Single Color Design..... 0020

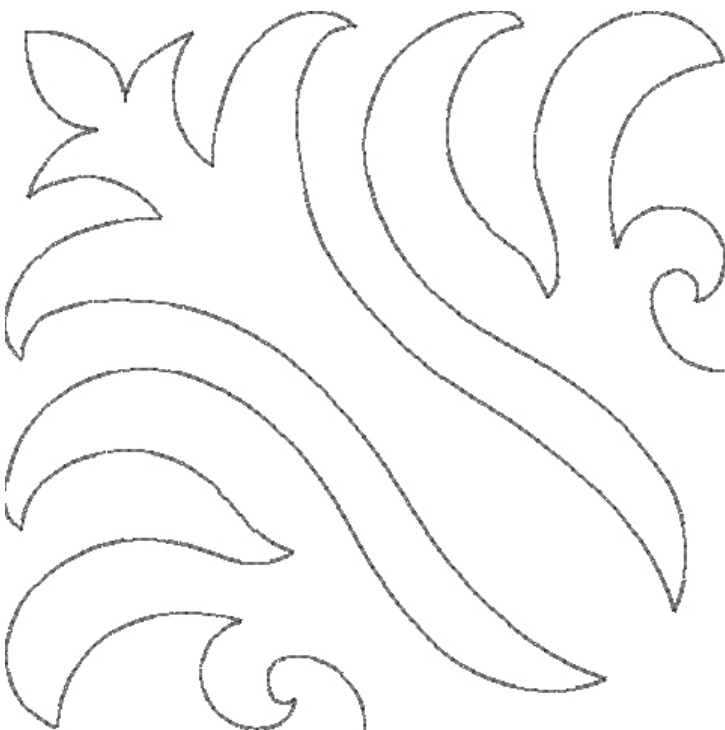

Note: Some designs in this collection may have been created using unique special stitches and/or techniques. To preserve design integrity when rescaling or rotating designs in your software, always rescale or rotate designs using the handles directly on-screen.

12736-17 Purple Star Quilt Motif 8

Size Inches: Size mm: Stitch Count:
5.00 X 5.00 in. **127.00 X 127.00 mm** **639 St.**

■ 1. Single Color Design..... 0020

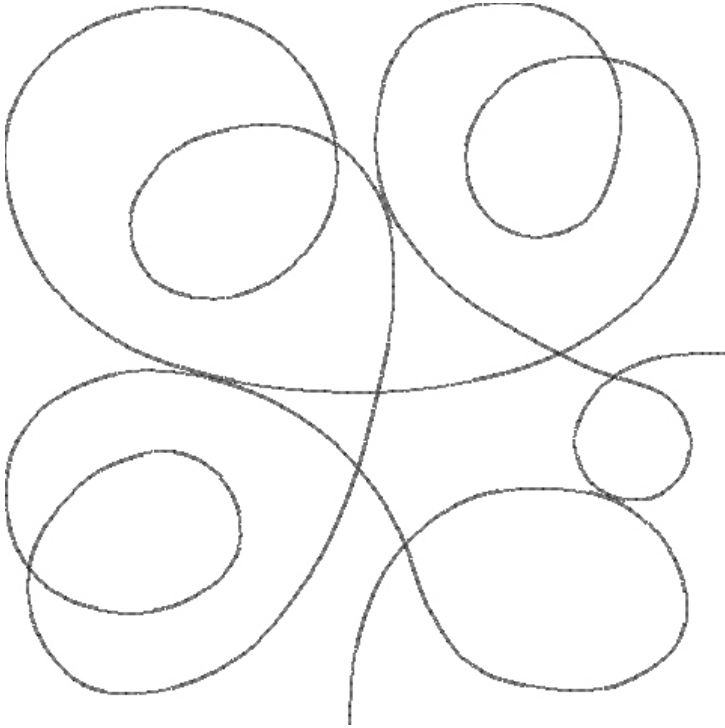

12736-18 Purple Star Quilt Motif 9

Size Inches: Size mm: Stitch Count:
4.42 X 4.42 in. **112.27 X 112.27 mm** **472 St.**

■ 1. Single Color Design..... 0020

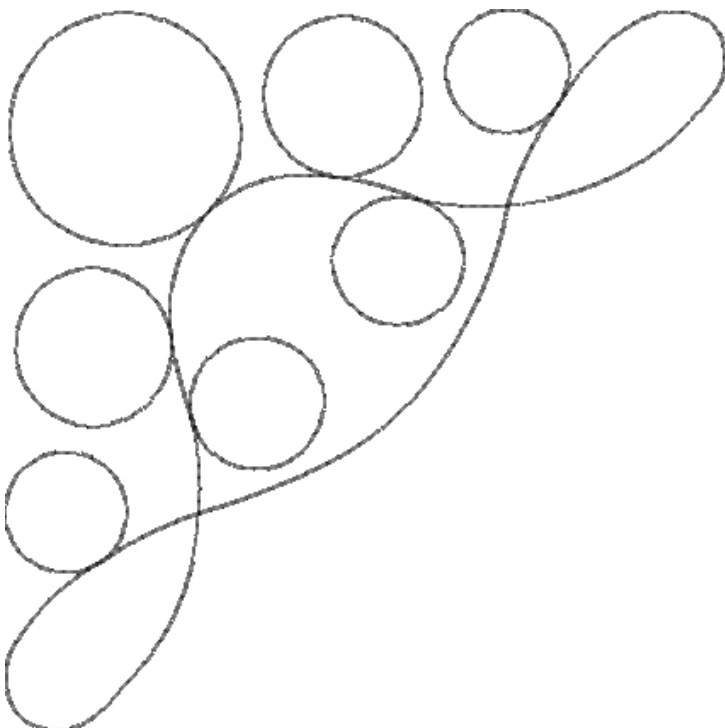

Stabilizer

- OEESD Ultra Clean and Tear Fusible Stabilizer

Fabric/Notions

Part One - Block Assembly

- Fabric selections based on block (dark, medium dark, medium light, light)
- Thread to coordinate with fabric
- Small craft iron

Part Two - Quilting

- 4 - 10.5" blocks
- Backing fabric 25" x 25" square
- Batting 25" x 25" square
- Thread (Isacord 40 wt. polyester)
- Bobbin with matching thread
- StabilStick Template Sheets
- 505 Temporary Spray Adhesive (*optional*)

INSTRUCTIONS



STEP 1

Note - All blocks are assembled similarly. Block 1 is being used in this example.

Use the paper piecing guide to cut fabrics large enough to cover the patch area.

Hint: To minimize fabric waste, cut apart a Printed Paper Guide along seamlines and add $\frac{1}{4}$ " to $\frac{1}{2}$ " excess to all sides for seam allowance.

Block Assembly

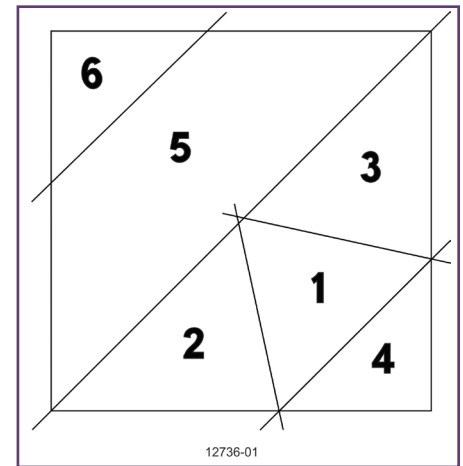

STEP 2

Hoop Ultra Clean and Tear Fusible with the fusible side up.



STEP 3

Stitch color 1, *Design Placement Guide 1* and *Placement Guide 1*. The numbers on the Paper Piecing Guide refer to the fabric placement sequence.

Hint: Write the numbers directly on the stabilizer with a water soluble or disappearing ink marker. Just make sure the numbers don't show through the fabric!

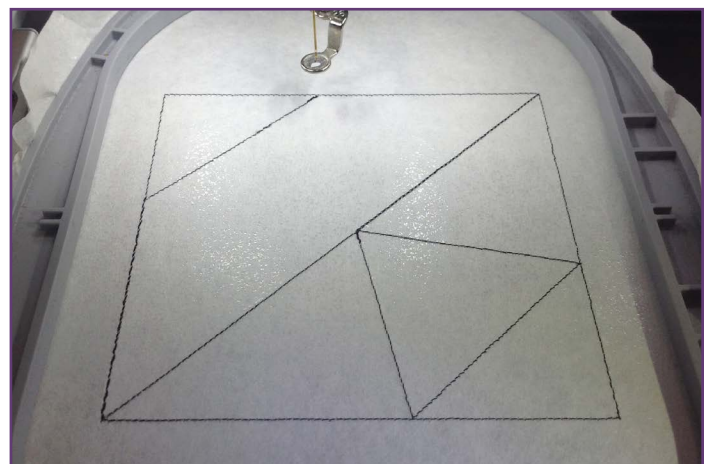

INSTRUCTIONS



STEP 4

Block Assembly

Lay fabric piece 1, right side up, completely covering the patch area. Fuse in place with a craft iron.

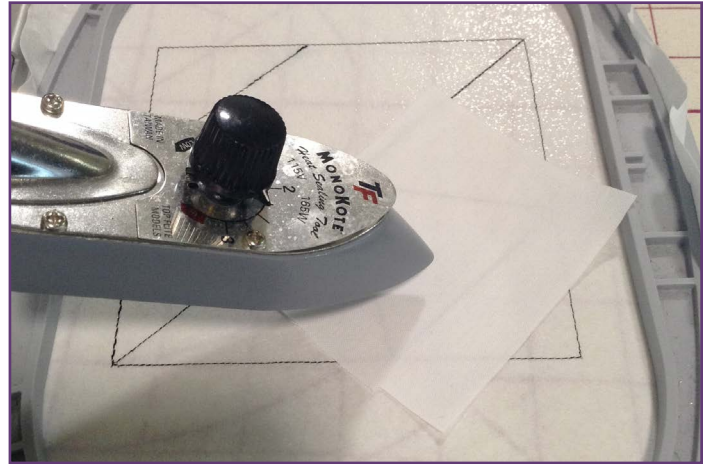

STEP 5

Stitch color 2, *Placement Guide 2*. (The stitching has been digitally enhanced for visibility.)

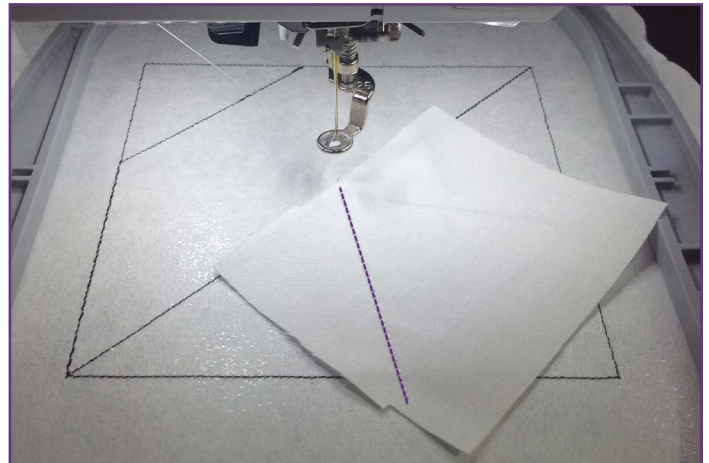

STEP 6

Trim away $\frac{1}{4}$ " from the seamline on the side by patch 2.

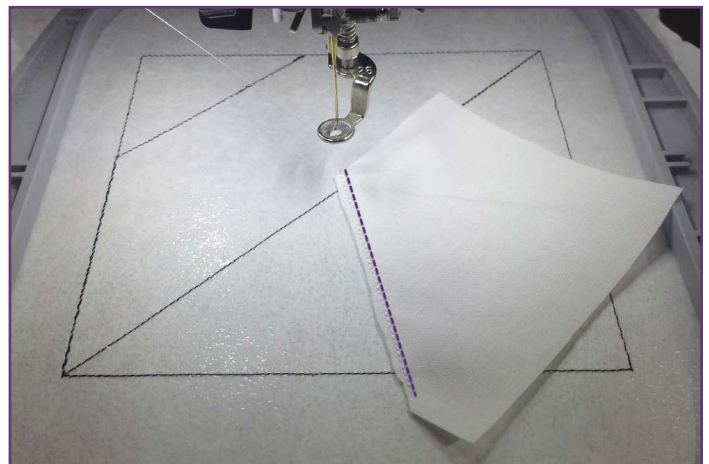

INSTRUCTIONS



STEP 7

Block Assembly

Position Patch 2 fabric, right side down, along seamline. If patch fabrics have been cut to shape with a seam allowance, align the raw edge with the raw edge of Patch 1.

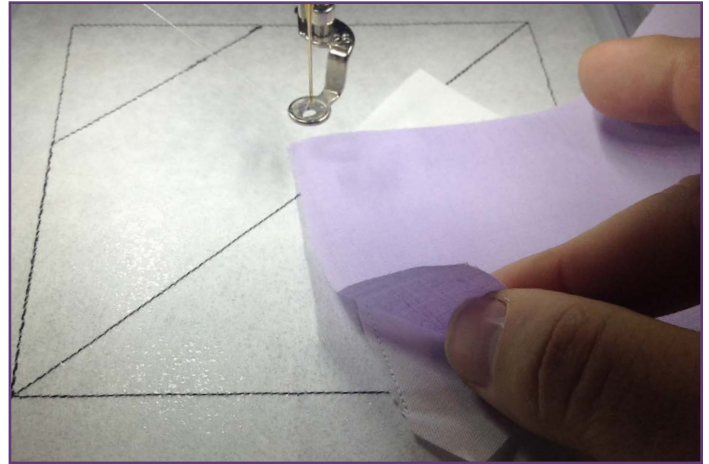

STEP 8

Stitch color 3, *Tackdown and Fold Line 2*. Trim the seam allowance to $\frac{1}{4}$ ", if necessary.

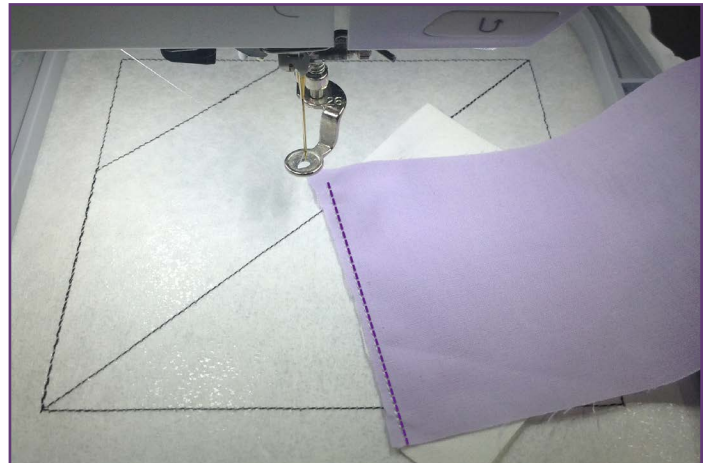

STEP 9

Flip the fabric over to cover Patch 2.



INSTRUCTIONS



STEP 10

Block Assembly

Press to secure.



STEP 11

Stitch color 4, the placement line for Patch 3.

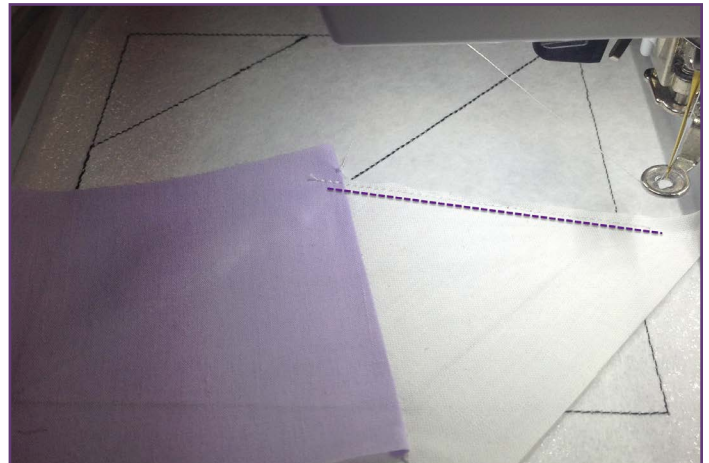

STEP 12

Position the fabric for Patch 3, right side down, over the seamline. Stitch color 5, *Tackdown and Fold Line 3*.

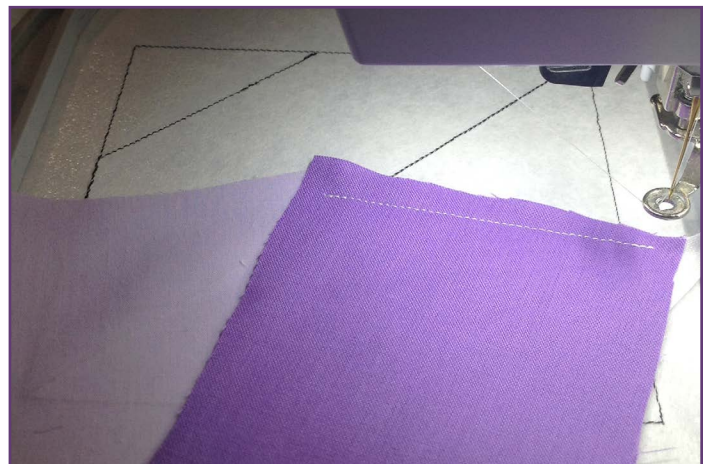

INSTRUCTIONS



STEP 13

Block Assembly

Flip the fabric over to cover Patch 3. Fuse to secure.



STEP 14

Stitch color 6, the placement line for Patch 4.

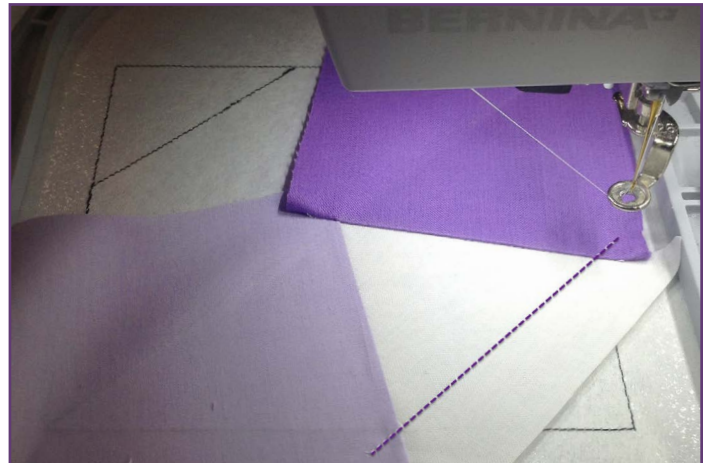

STEP 15

Trim seam allowance to about ¼".



INSTRUCTIONS



STEP 16

Block Assembly

Position Patch 4 fabric, right side down, over the seamline. Stitch color 7, *Tackdown and Fold Line* 4.



STEP 17

Flip fabric open and press to secure.

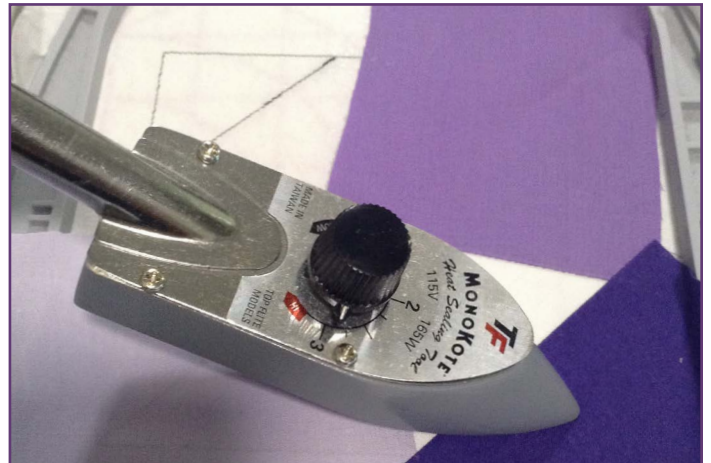

STEP 18

Stitch color 8, the placement line for Patch 5.

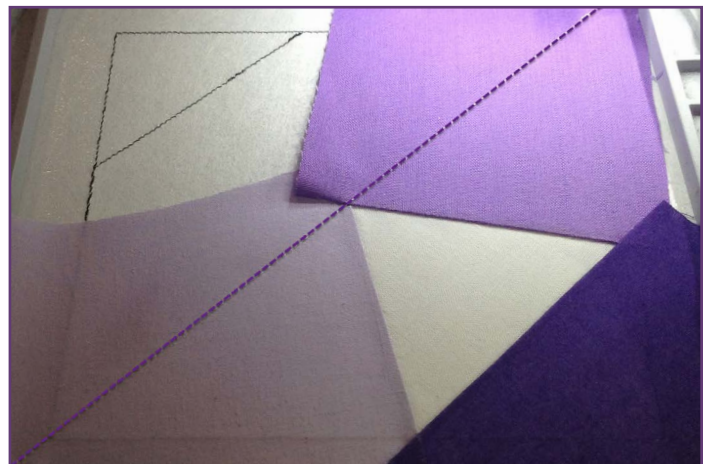

INSTRUCTIONS



STEP 19

Block Assembly

Trim to away excess from seam allowance.

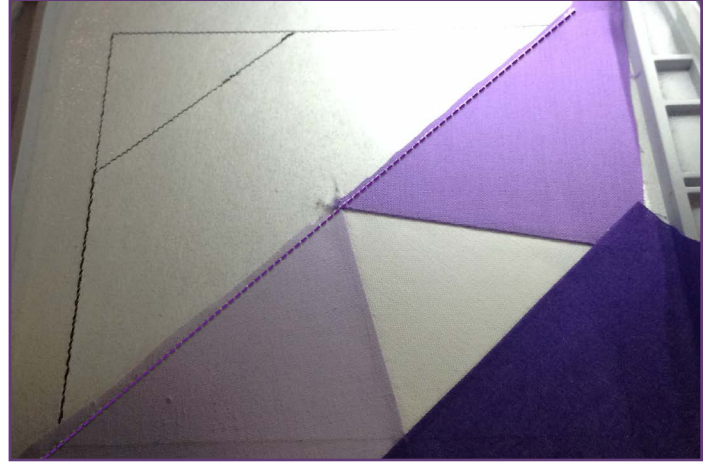

STEP 20

Position Patch 5 fabric, right side down, over seamline. Stitch color 9 to secure the fabric.



STEP 21

Flip fabric over Patch 5 and press to secure.

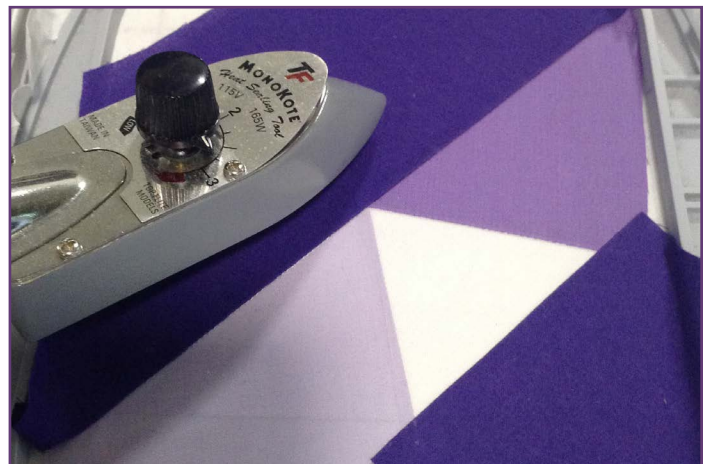

INSTRUCTIONS



STEP 22

Block Assembly

Stitch color 10, the placement line for Patch 6.

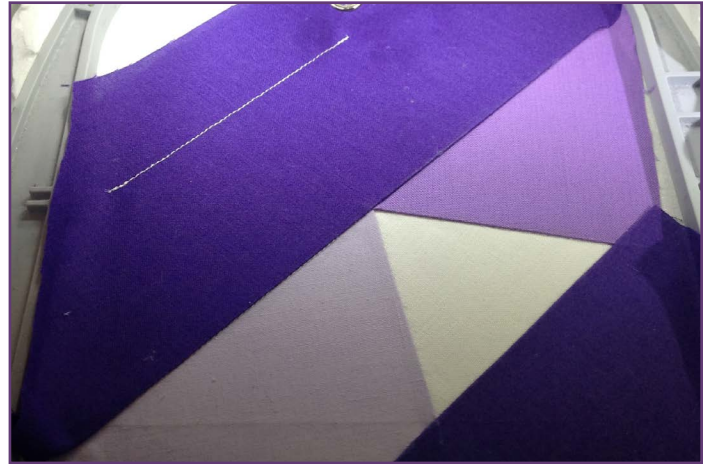

STEP 23

Trim the excess fabric from the seam allowance.

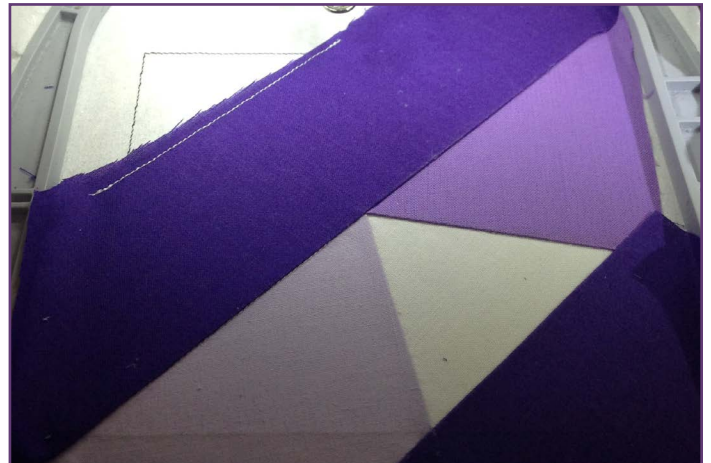

STEP 24

Position Patch 6 fabric, right side down, over seamline. Stitch color 11 to secure.



INSTRUCTIONS



STEP 25

Block Assembly

Flip the fabric over Patch 6 and press to secure.

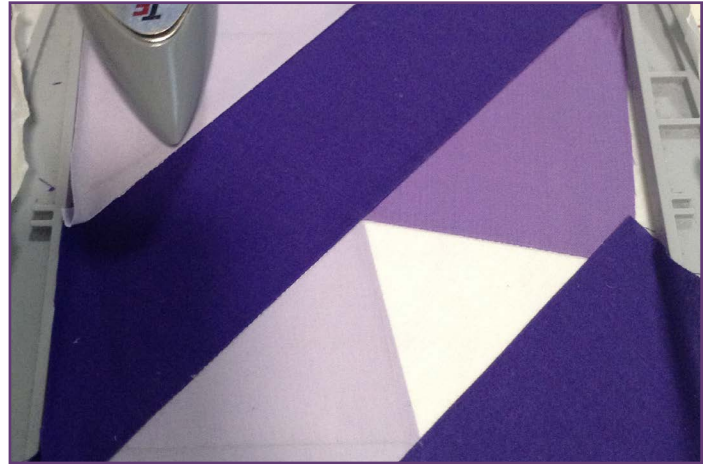

STEP 26

Stitch Color 12. This stitching will secure all loose edges to the stabilizer and stitches $\frac{1}{8}$ " into the seam allowance.



STEP 27

Remove the block from the hoop. Trim block $\frac{1}{8}$ " from final stitching. OR, turn block to wrong side and trim $\frac{1}{4}$ " from original block pattern from Step 3.

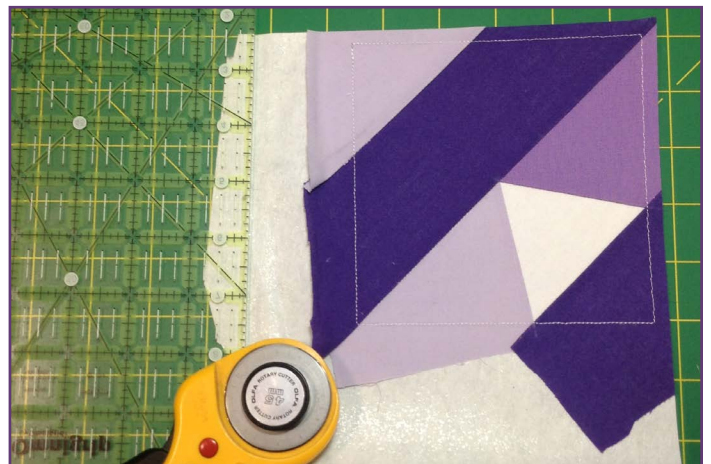

INSTRUCTIONS



STEP 28

Block Assembly

Unfinished size of block is 5.5" square.

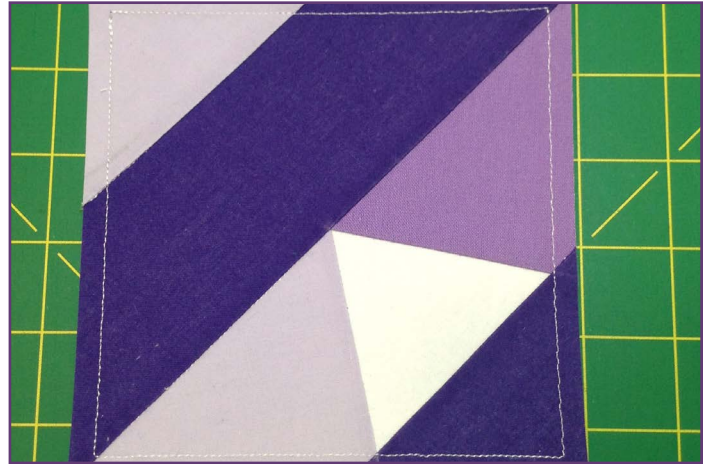

STEP 29

Machine sew four blocks together with $\frac{1}{4}$ " seam allowance as shown. Combined block will measure 10.5" (including $\frac{1}{4}$ " seam allowance on all sides).

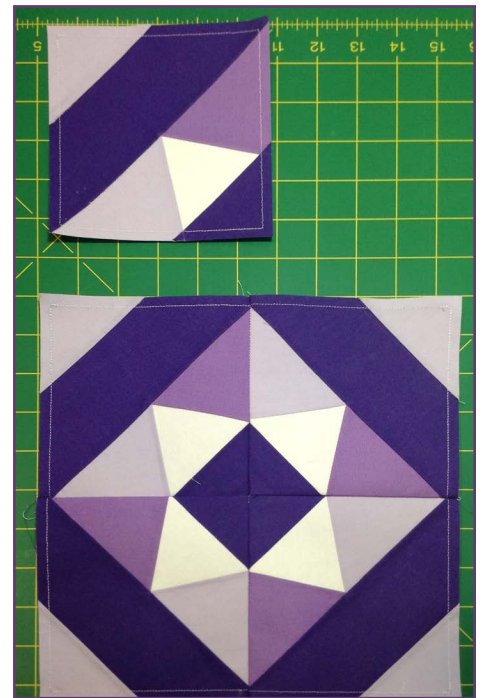

INSTRUCTIONS



Quilt Assembly

STEP 1

Assemble Quilt

Stitch blocks together as shown. Use pins to match points and corners. Press seams and quilt.

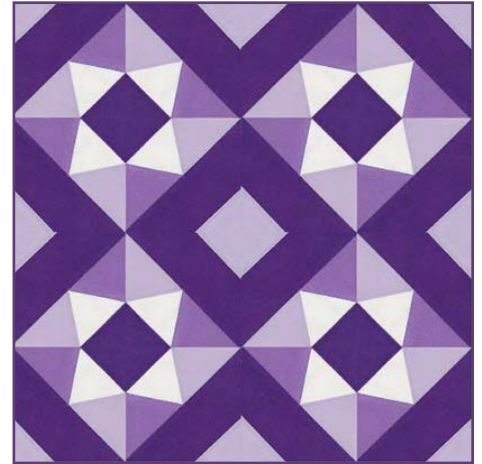

STEP 2

Print Template

Print a design template on a StabilStick Template Sheet (or, a piece of StabilStick Tearaway cut to 8.5" x 11"). Mark the top of the design before trimming if it is not marked. Trim close to edges.

Photo 1

If the hoop is large enough to accommodate multiple designs, they may be combined onto a single template or stitched separately in the same hooping. **Photo 2**

Note: The advantage of a StabilStick Template is that it is translucent, will stay in place during hoop and is reusable multiple times!

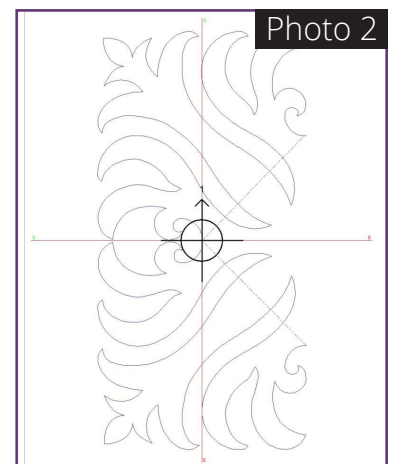
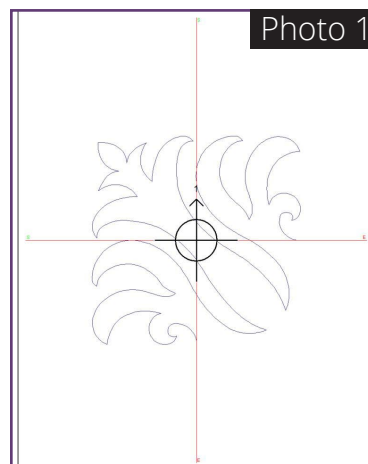

INSTRUCTIONS



Quilt Assembly

STEP 3

Quilt Sandwich

Create a quilt sandwich with the backing fabric on the bottom, right side down and the batting on top. Center the quilt on the top of the batting. Right side up. There should be 2" - 2.5" allowance around all sides. This extra fabric will facilitate hooping. Temporary spray adhesive may be used to hold layers together. Alternately, pins may be used but must be removed when stitching in that area.



STEP 4

Hooping

Hoop the quilt sandwich using the hoop template to ensure the stitching area is straight and in the embroidery field of the hoop.

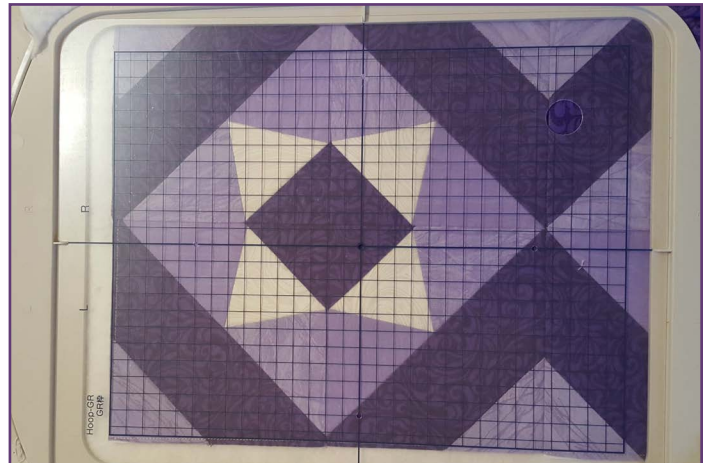

STEP 5

Apply Template

Apply the template to the quilt top in the proper position. This template is for half of the block (two of the original 5" blocks). Notice the translucency of the template. The center horizontal line is lined up with the horizontal seam line and the edges of the design at the edges of the block.



INSTRUCTIONS



Quilt Assembly

STEP 6

Prepare to Embroider

At the machine, load the design. With the needle in the center of the design, move the hoop to position the crosshair of the template directly under the needle. Trace the design if necessary to check for straight hooping.

REMOVE THE TEMPLATE by peeling it off the fabric. Set it aside to be reused on the next hooping.

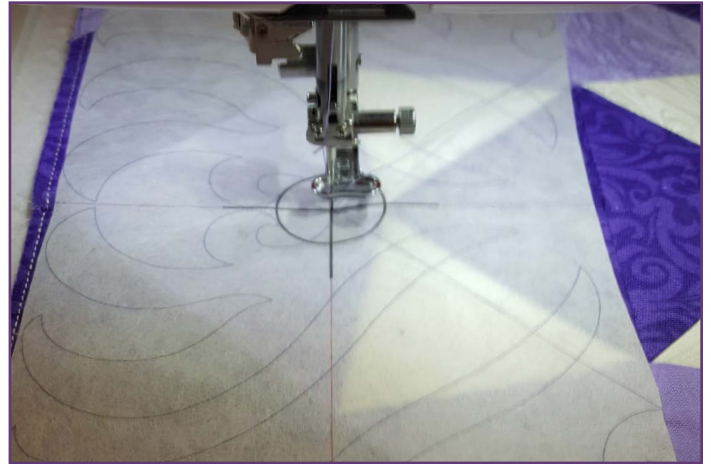

STEP 7

Bobbin Thread

Advance the machine one stitch. Hold the top thread while dropping and raising the needle. This will pull the bobbin thread to the top. Press go and stitch a few stitches to lock the threads. Stop. **Photo 1**

Trim the top and bobbin threads. This will keep the back of the quilt looking neat with no tangled threads. **Photo 2**



STEP 8

Stitch Design

Press go and finish stitching the design.

Repeat the process from Step 4 for the entire quilt, rotating the designs as necessary per the template.

Trim excess fabric and batting to $\frac{3}{8}$ " border stitching on blocks.

Complete the raw edges with your preferred binding method.



- For a larger quilt, it is best to begin in the center working out to each side, top and bottom.
- To double check point to point placement, move to the first stitch of the design and see if it matches the previous stitch. Make any minor adjustments. It may be necessary to step through to the end of the design it that is where the designs connect.



- Test the design on a quilt sandwich and see if the top thread pulls to the back (like standard embroidery tension). If so, adjust the tension so the knot is made in the batting and not on the back by increasing the top.

ATTENTION

When printing this document, any page scaling or page fitting options in your print dialog box must be turned OFF or set to NONE so that your files will print out at their actual size. Images not printed at actual size will not function as intended.

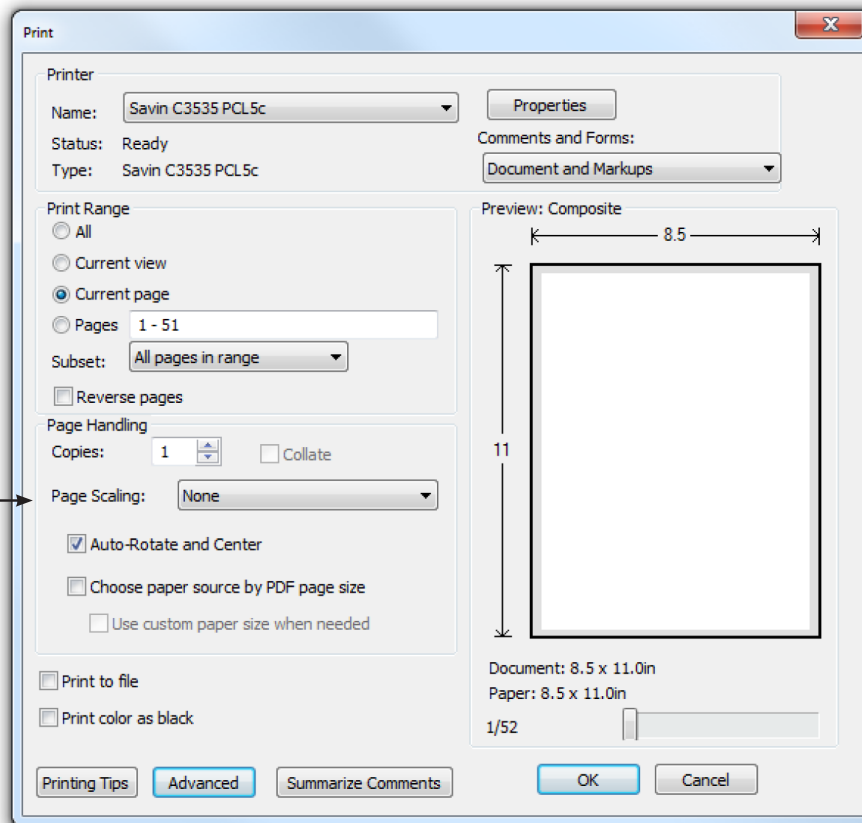

TO SAVE PAPER

Only print the desired image by navigating to the image's page, go to File > Print and select "Current page" in the print dialog box. Repeat for each desired image.

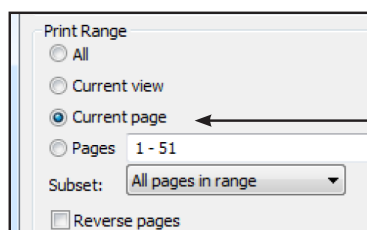

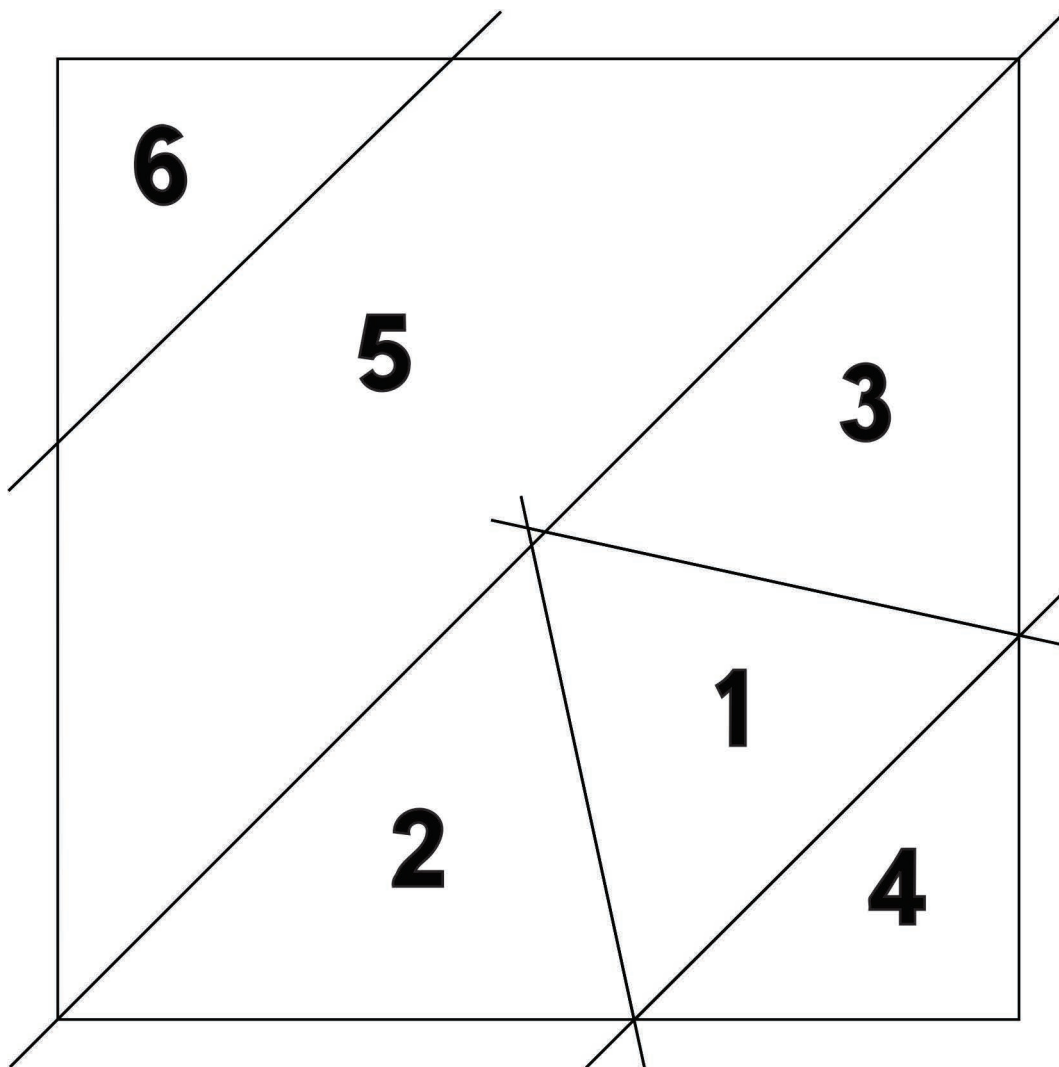

12736-01

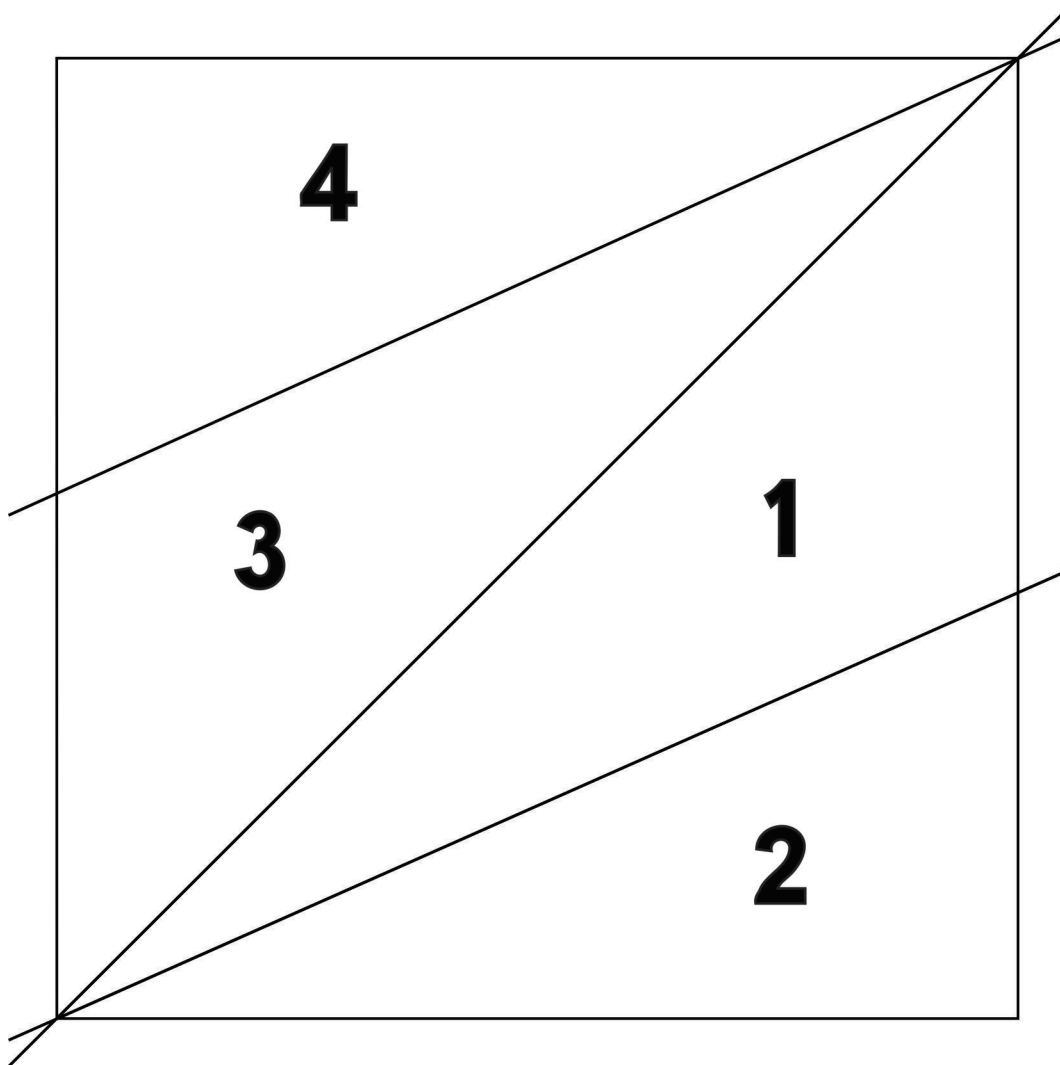

12736-02

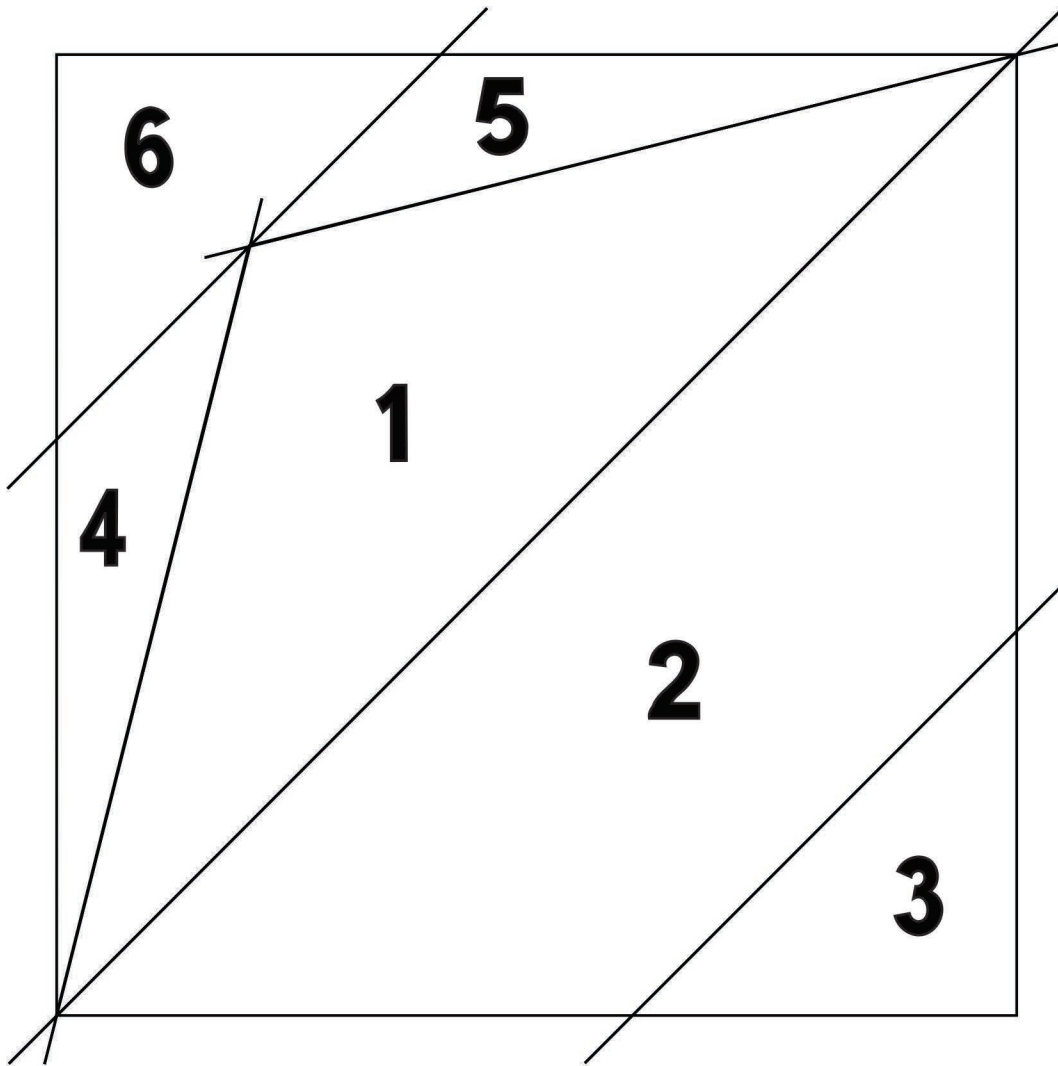

12736-03

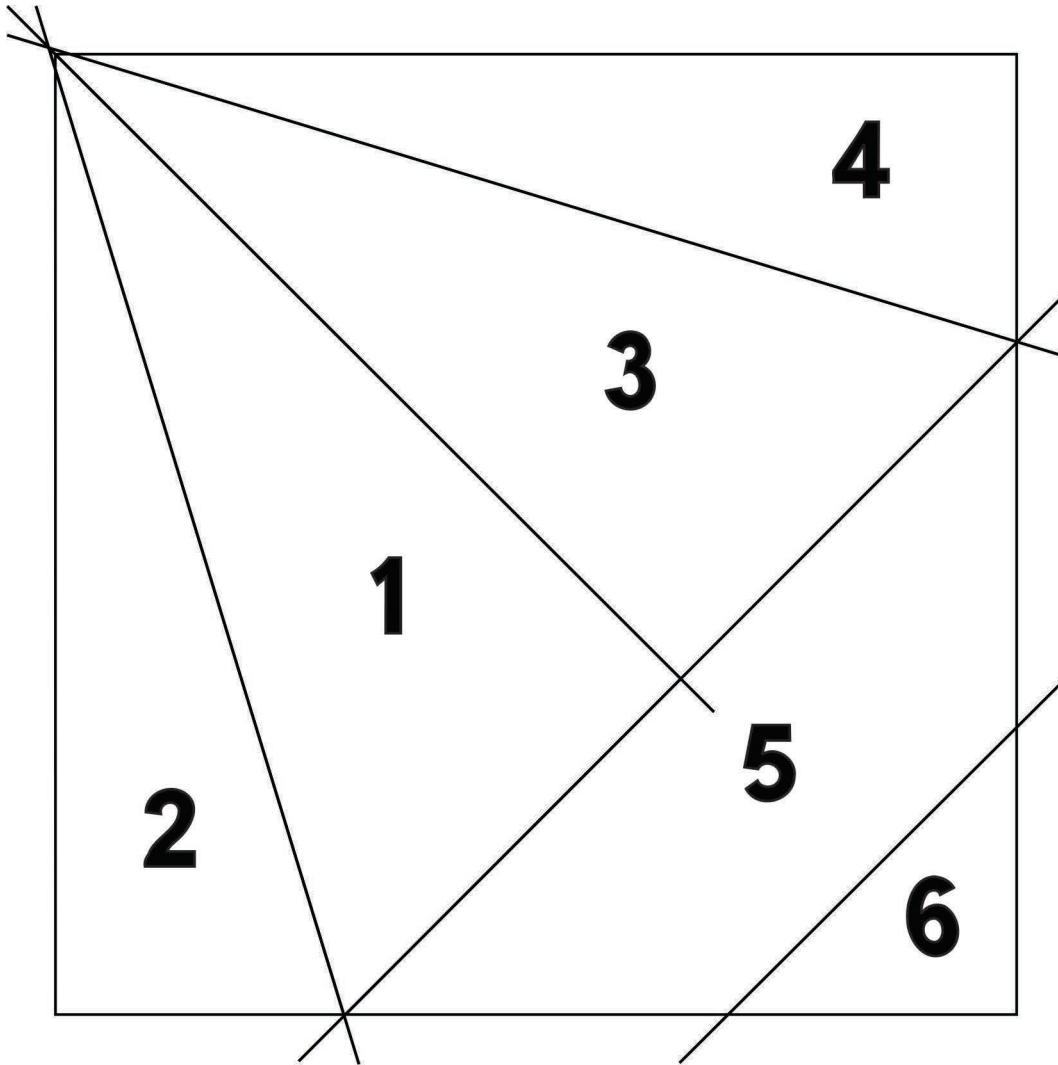

12736-04

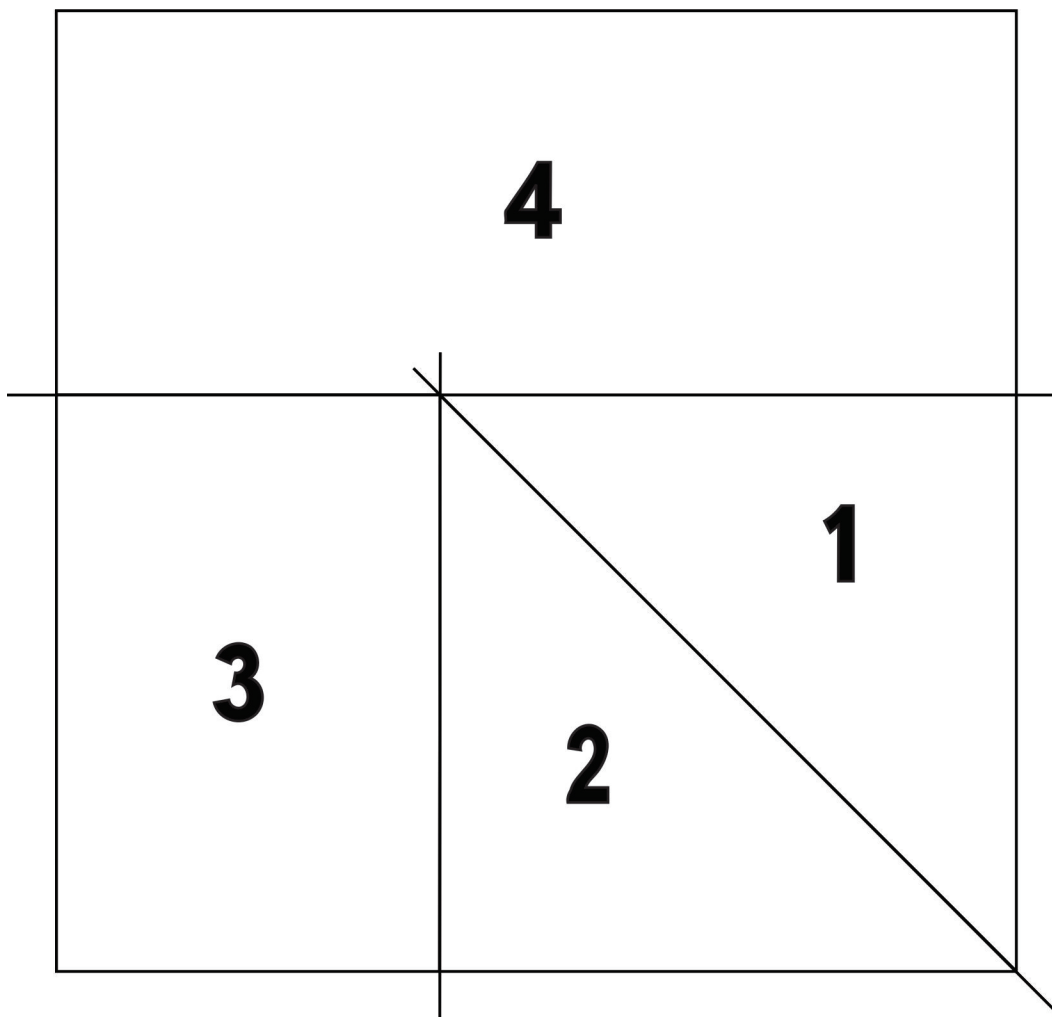

12736-05

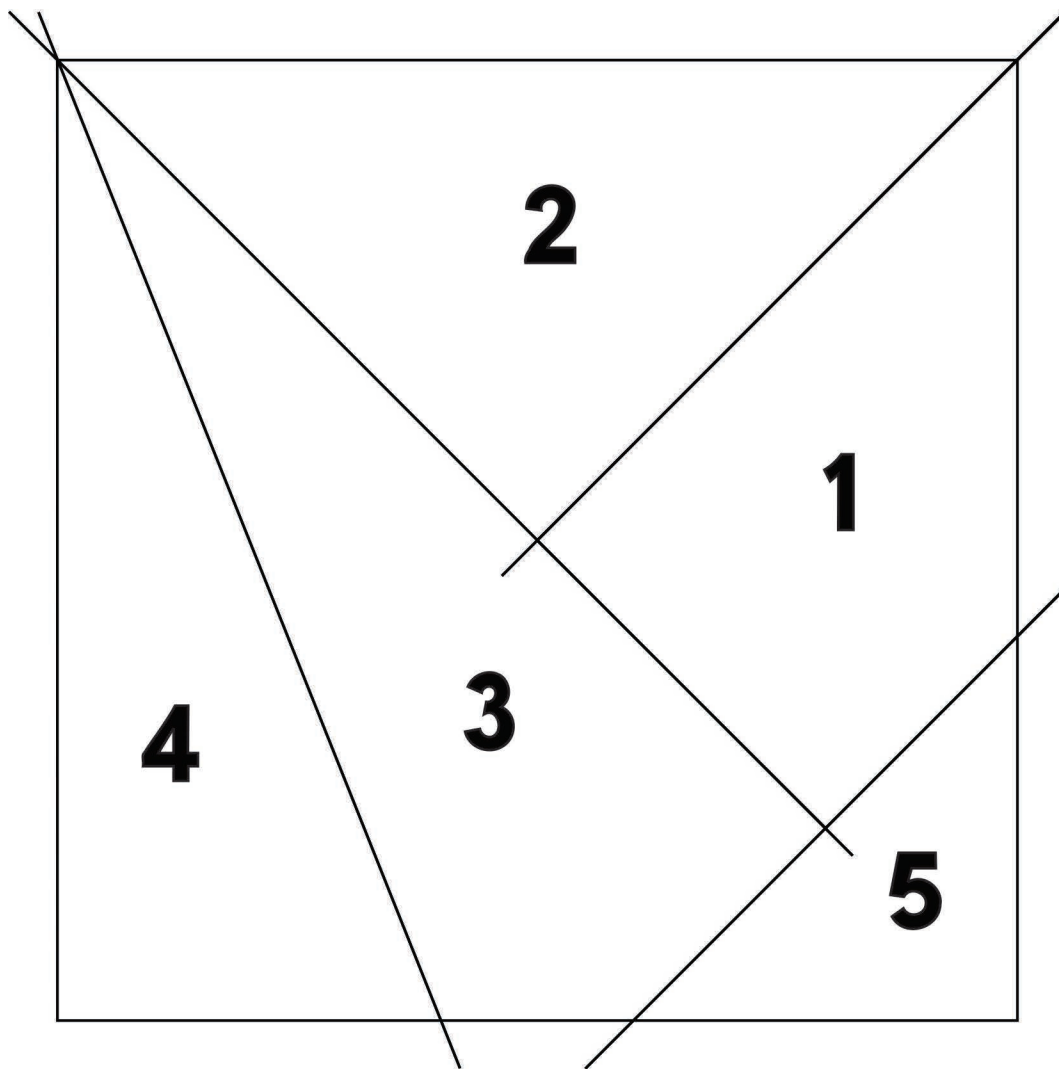

12736-06

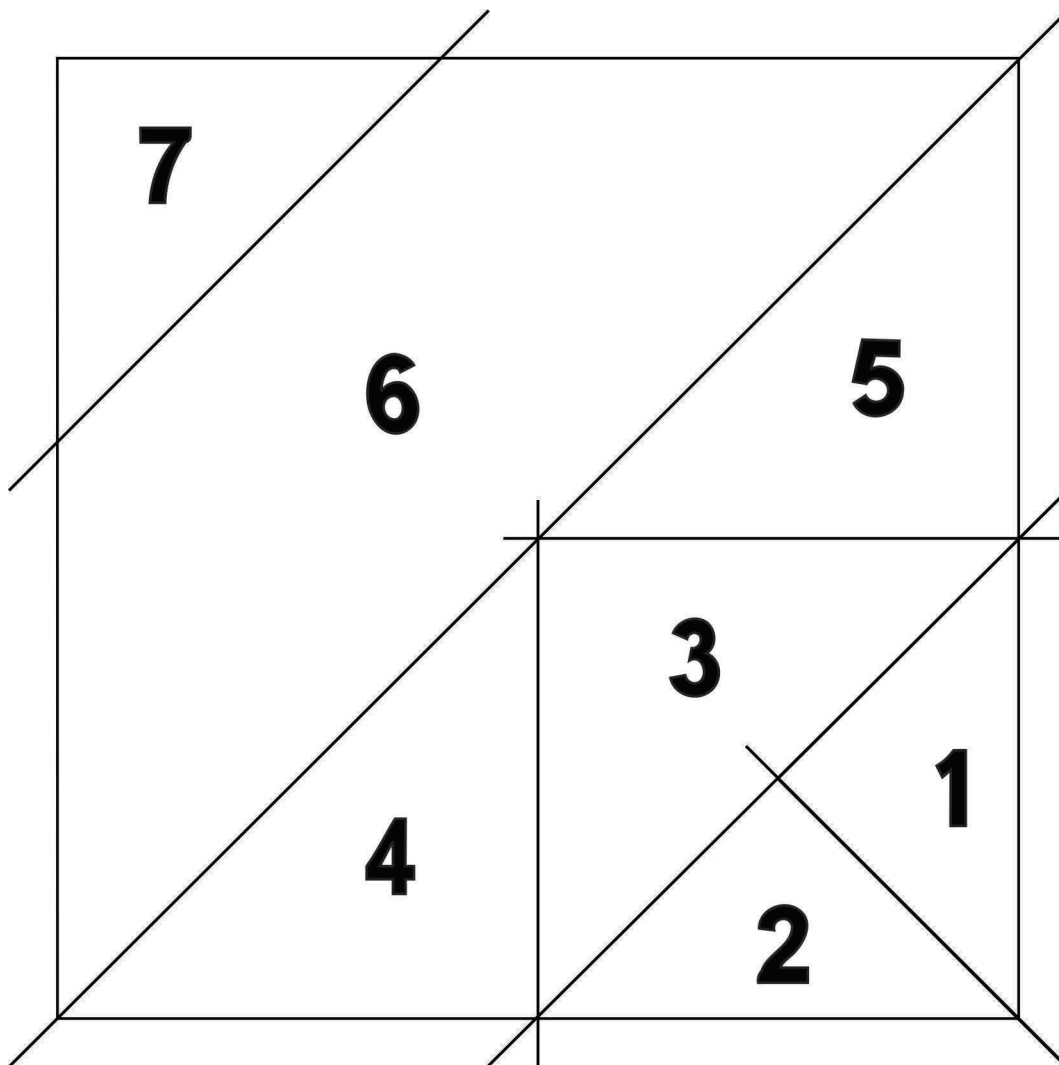

12736-07

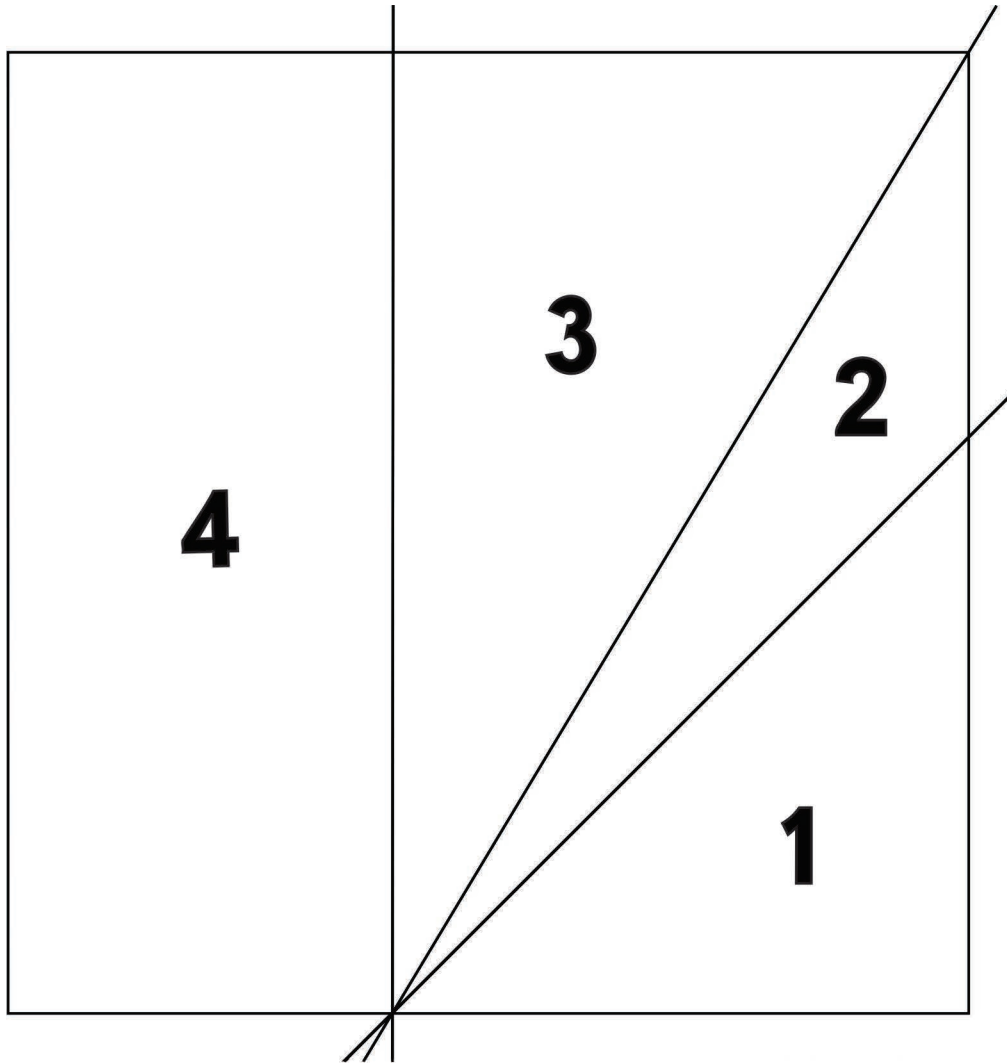

12736-08

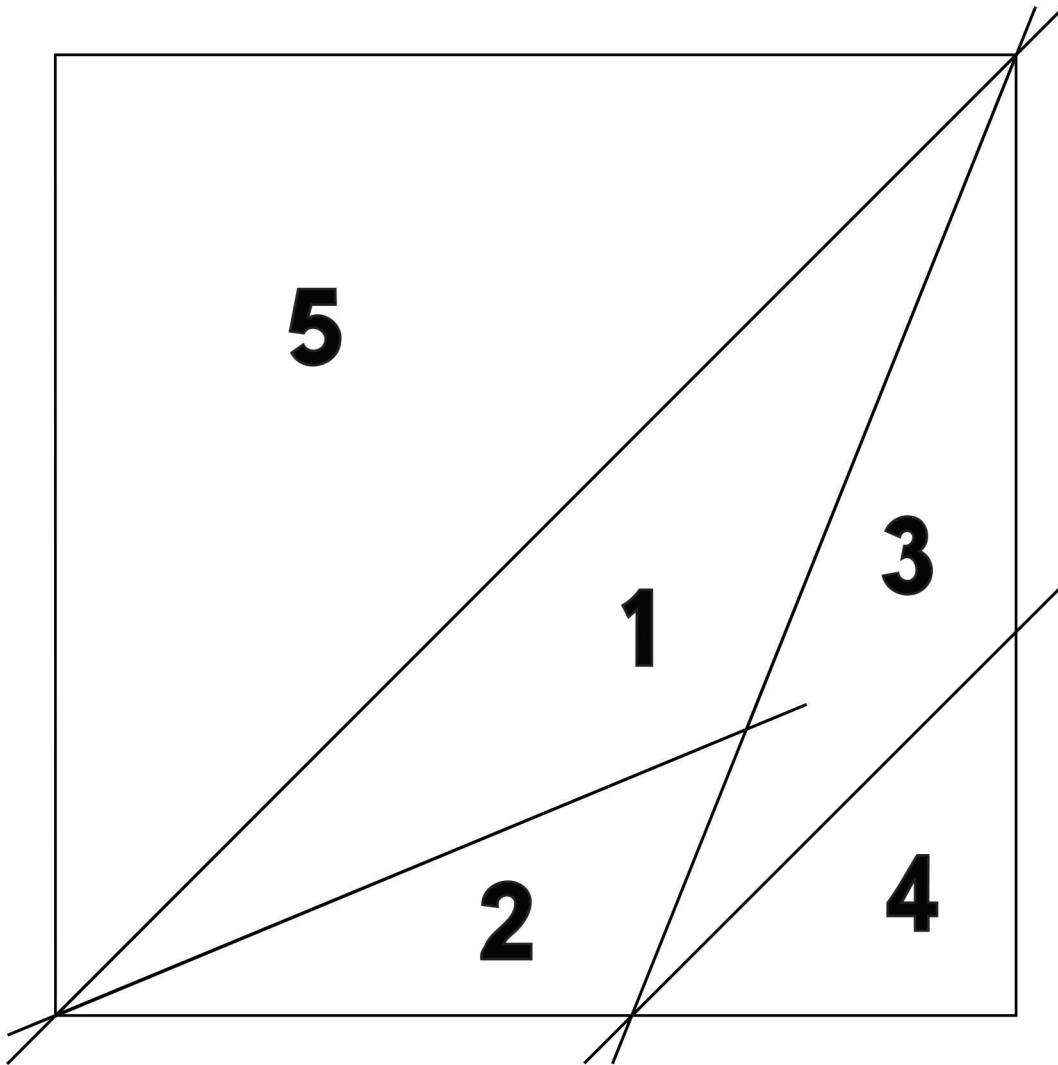

12736-09

Block + Design Combination Options

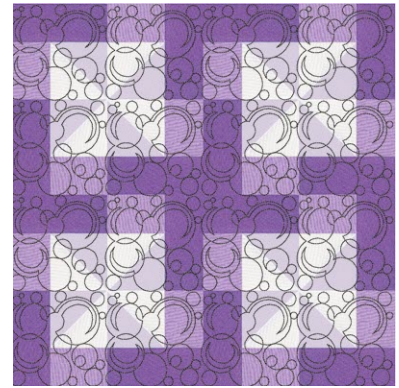
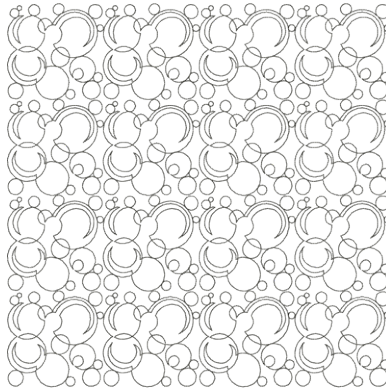
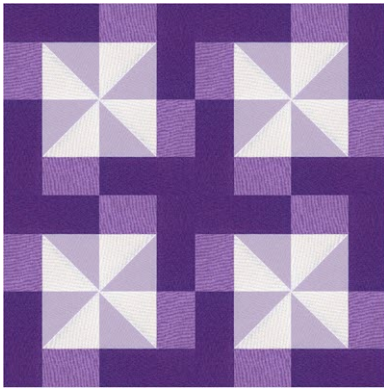

Block 9 + Design 11

1 design for each 5" square block. No point to point connections.

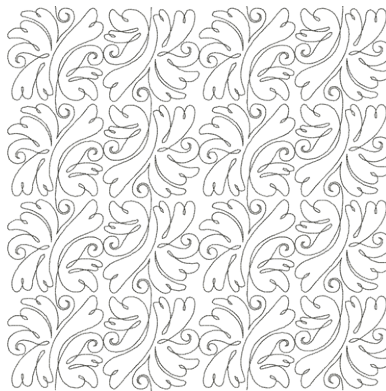
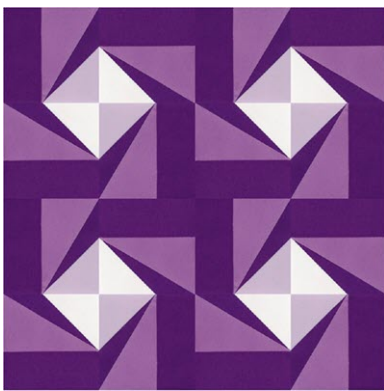

Block 6 + Design 12

1 design for each 5" square block.
Point to point connections at center top and bottom

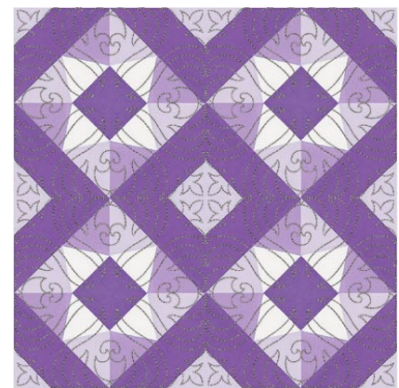
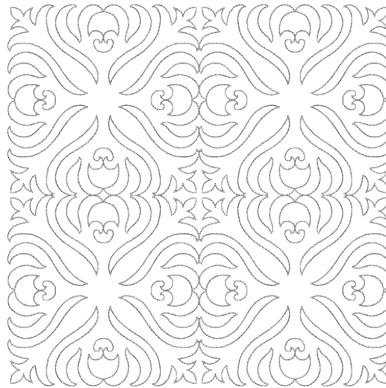
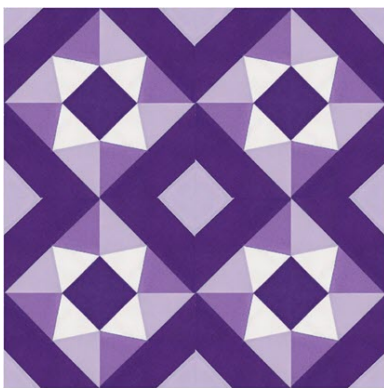

Block 1 + Design 16

Each 5" design rotated 90° 4 times to create a 10" square block.

It is a violation of Copyright law to make and distribute copies of instructions or artwork.
Electronic designs are licensed to the original purchaser for use at one location. ©2018 OESD, LLC. All rights reserved.

Block + Design Combination Options

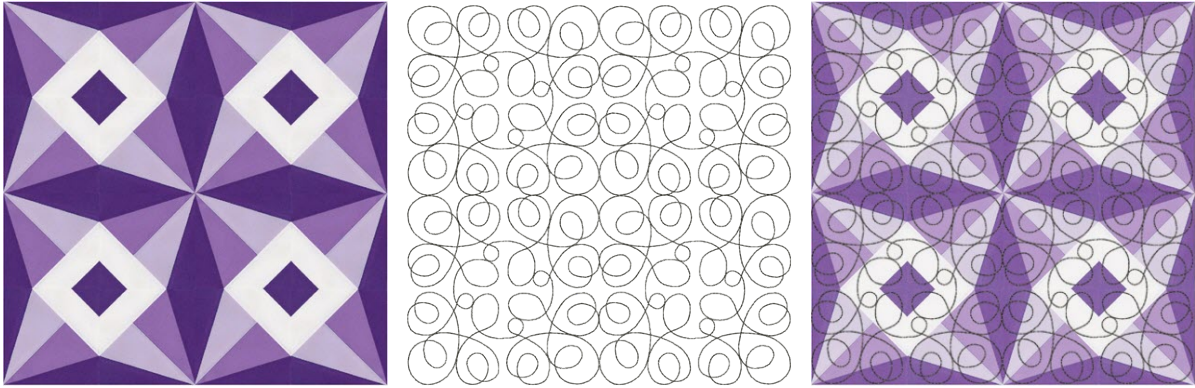

Block 4 + Design 17

Each 5" design rotated 90° 4 times to create a 10" square block.

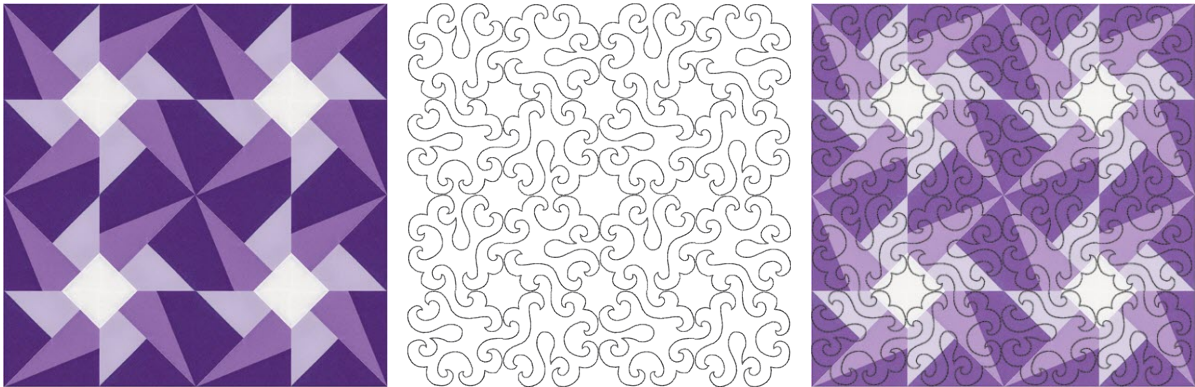

Block 5 + Design 14

Each 5" design rotated 90° 4 times to create a 10" square block.

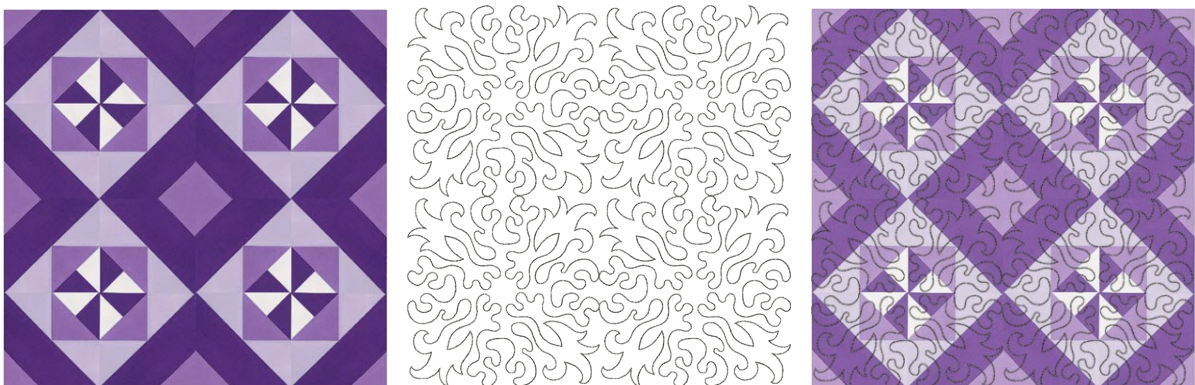

Block 7 + Design 15

Each 5" design rotated 90° 4 times to create a 10" square block.

Block + Design Combination Options

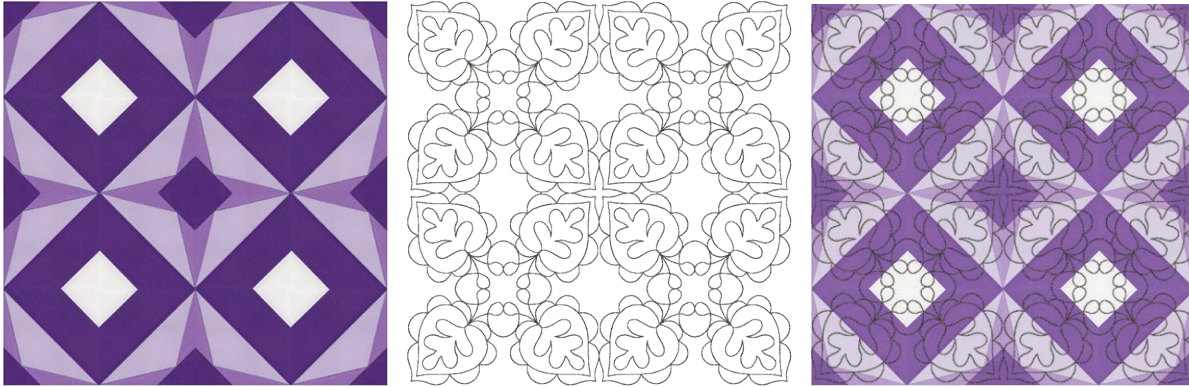

Block 8 + Design 13

Each 5" design rotated 90° 4 times to create a 10" square block.

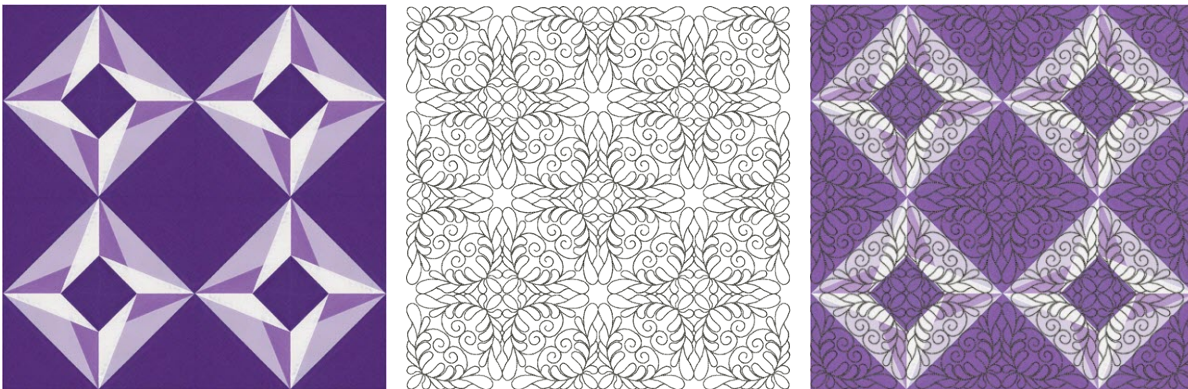

Block 2 + Design 10

2 designs at 45° angle mirror imaged (or 180° rotation) to create a 5" square block.
Each 5" block rotated 90° 4 times to create a 10" square block.

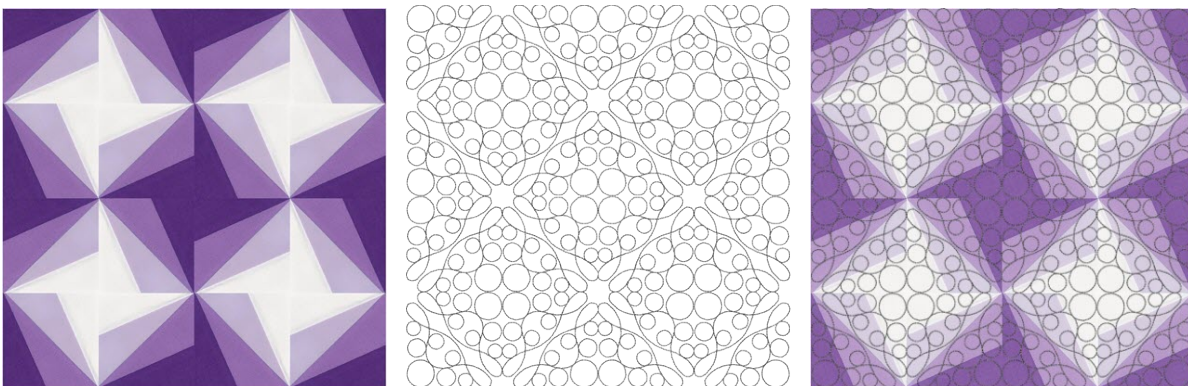

Block 3 + Design 18

2 designs at 45° angle mirror imaged (or 180° rotation) to create a 5" square block.
Each 5" block rotated 90° 4 times to create a 10" square block.

It is a violation of Copyright law to make and distribute copies of instructions or artwork.
Electronic designs are licensed to the original purchaser for use at one location. ©2018 OESD, LLC. All rights reserved.