

#12806

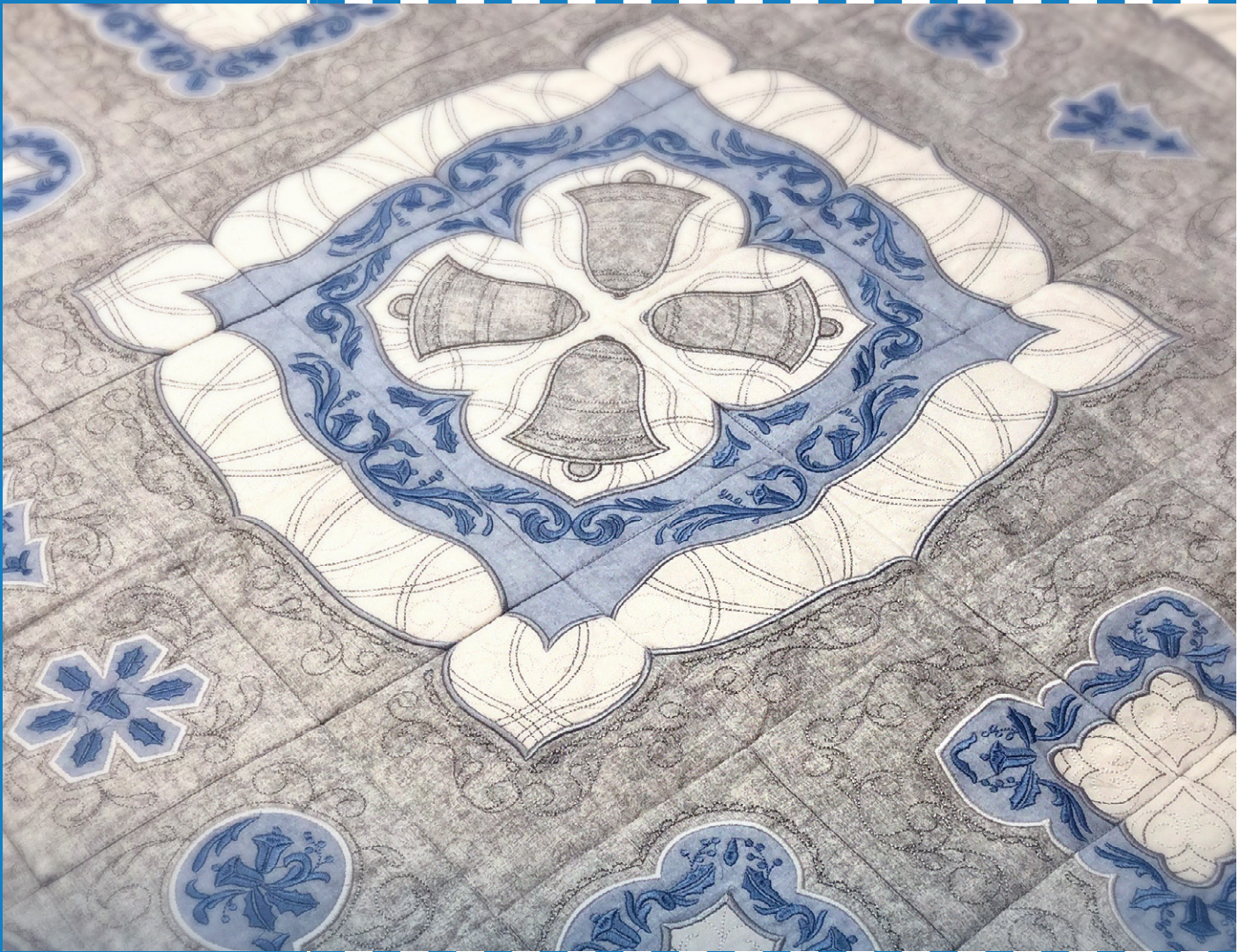

**27**  
DESIGNS

# Silver Bells Quilt

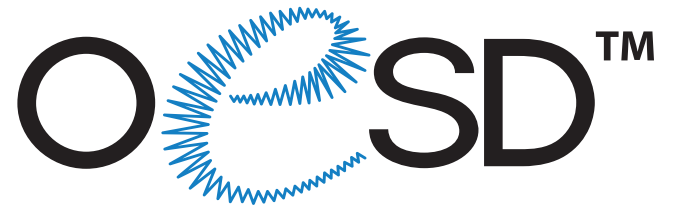

Note: Some designs in this collection may have been created using unique special stitches and/or techniques. To preserve design integrity when rescaling or rotating designs in your software, always rescale or rotate designs using the handles directly on-screen.

\*Fabric Required



## 12806-01 Applique Tile 1

Size Inches:                      Size mm:                      Stitch Count:  
**5.37 X 5.35 in.**    **136.40 X 135.89 mm**    **15575 St.**

- 1. Seam with Matching Bobbin Thread ..... 0020
- 2. Light Blue Fabric Placement Stitch ..... 3762
- 3. Cut Line and Tackdown ..... 3762
- 4. White Fabric Placement Stitch ..... 3762
- 5. Cut Line and Tackdown ..... 3762
- 6. Silver Fabric Placement Stitch ..... 3762
- 7. Cut Line and Tackdown ..... 3762
- 8. Blue Detail ..... 3762
- 9. Silver Metallic Linework ..... 7005
- 10. White Linework ..... 0015
- 11. Light Gray Cover Stitch ..... 0145
- 12. Silver Metallic Cover Stitch and Scallops ..... 7005

\*Fabric Required



## 12806-02 Applique Tile 2

Size Inches:                      Size mm:                      Stitch Count:  
**5.38 X 5.38 in.**    **136.65 X 136.65 mm**    **15328 St.**

- 1. Seam with Matching Bobbin Thread ..... 0020
- 2. Silver Fabric Placement Stitch ..... 0145
- 3. Cut Line and Tackdown ..... 0145
- 4. Light Blue Fabric Placement Stitch ..... 0145
- 5. Cut Line and Tackdown ..... 0145
- 6. White Fabric Placement Stitch ..... 0145
- 7. Cut Line and Tackdown ..... 0145
- 8. Silver Metallic Scallops ..... 7005
- 9. Blue Detail ..... 3762
- 10. White Cover Stitch ..... 0015
- 11. White Linework ..... 0015
- 12. Silver Metallic Linework ..... 7005
- 13. Light Gray Cover Stitch ..... 0145



Note: Some designs in this collection may have been created using unique special stitches and/or techniques. To preserve design integrity when rescaling or rotating designs in your software, always rescale or rotate designs using the handles directly on-screen.

\*Fabric Required



## 12806-03 Applique Tile 3

Size Inches:                      Size mm:                      Stitch Count:  
**5.38 X 5.39 in.    136.65 X 136.91 mm    15549 St.**

- 1. Seam with Matching Bobbin Thread ..... 0020
- 2. Silver Fabric Placement Stitch ..... 0145
- 3. Cut Line and Tackdown ..... 0145
- 4. Light Blue Fabric Placement Stitch ..... 0145
- 5. Cut Line and Tackdown ..... 0145
- 6. White Fabric Placement Stitch ..... 0145
- 7. Cut Line and Tackdown ..... 0145
- 8. Silver Metallic Scallops..... 7005
- 9. Blue Detail ..... 3762
- 10. White Cover Stitch..... 0015
- 11. White Linework..... 0015
- 12. Silver Metallic Linework..... 7005
- 13. Light Gray Cover Stitch ..... 0145

\*Fabric Required



## 12806-04 Applique Tile 4

Size Inches:                      Size mm:                      Stitch Count:  
**5.38 X 5.37 in.    136.65 X 136.40 mm    16123 St.**

- 1. Seam with Matching Bobbin Thread ..... 0020
- 2. Silver Fabric Placement Stitch ..... 0145
- 3. Cut Line and Tackdown ..... 0145
- 4. Light Blue Fabric Placement Stitch ..... 0145
- 5. Cut Line and Tackdown ..... 0145
- 6. White Fabric Placement Stitch ..... 0145
- 7. Cut Line and Tackdown ..... 0145
- 8. Silver Metallic Scallops..... 7005
- 9. Blue Detail ..... 3762
- 10. White Cover Stitch..... 0015
- 11. White Linework..... 0015
- 12. Silver Metallic Linework..... 7005
- 13. Light Gray Cover Stitch ..... 0145



Note: Some designs in this collection may have been created using unique special stitches and/or techniques. To preserve design integrity when rescaling or rotating designs in your software, always rescale or rotate designs using the handles directly on-screen.

\*Fabric Required



## 12806-05 Applique Tile 5

Size Inches:                      Size mm:                      Stitch Count:  
**5.38 X 5.39 in.**    **136.65 X 136.91 mm**    **15604 St.**

- 1. Seam with Matching Bobbin Thread ..... 0020
- 2. Silver Fabric Placement Stitch ..... 0145
- 3. Cut Line and Tackdown ..... 0145
- 4. Light Blue Fabric Placement Stitch ..... 0145
- 5. Cut Line and Tackdown ..... 0145
- 6. White Fabric Placement Stitch ..... 0145
- 7. Cut Line and Tackdown ..... 0145
- 8. Silver Metallic Scallops..... 7005
- 9. Blue Detail ..... 3762
- 10. White Cover Stitch..... 0015
- 11. White Linework..... 0015
- 12. Silver Metallic Linework..... 7005
- 13. Light Gray Cover Stitch ..... 0145

\*Fabric Required

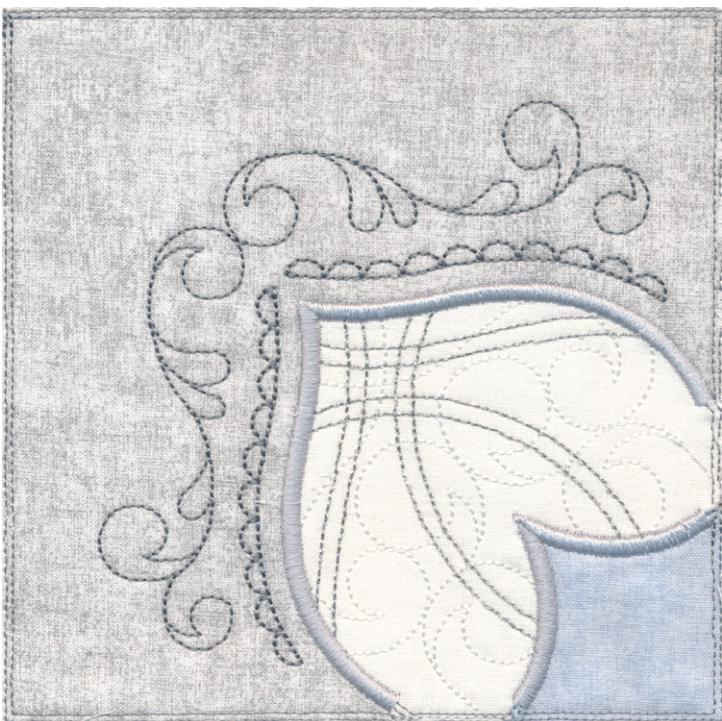

## 12806-06 Applique Tile 6

Size Inches:                      Size mm:                      Stitch Count:  
**5.39 X 5.38 in.**    **136.91 X 136.65 mm**    **8642 St.**

- 1. Seam with Matching Bobbin Thread ..... 0020
- 2. Silver Fabric Placement Stitch ..... 0145
- 3. Cut Line and Tackdown ..... 0145
- 4. White Fabric Placement Stitch ..... 0145
- 5. Cut Line and Tackdown ..... 0145
- 6. Light Blue Fabric Placement Stitch ..... 0145
- 7. Cut Line and Tackdown ..... 0145
- 8. Silver Metallic Scallops and Swirls ..... 7005
- 9. White Linework..... 0015
- 10. Silver Metallic Linework..... 7005
- 11. Light Gray Cover Stitch ..... 0145



Note: Some designs in this collection may have been created using unique special stitches and/or techniques. To preserve design integrity when rescaling or rotating designs in your software, always rescale or rotate designs using the handles directly on-screen.

\*Fabric Required



## 12806-07 Applique Tile 7

Size Inches:                      Size mm:                      Stitch Count:  
**5.39 X 5.38 in.**    **136.91 X 136.65 mm**    **13398 St.**

- 1. Seam with Matching Bobbin Thread ..... 0020
- 2. Light Blue Fabric Placement Stitch ..... 0145
- 3. Cut Line and Tackdown ..... 0145
- 4. White Fabric Placement Stitch ..... 0145
- 5. Cut Line and Tackdown ..... 0145
- 6. Silver Fabric Placement Stitch ..... 0145
- 7. Cut Line and Tackdown ..... 0145
- 8. Silver Metallic Scallops..... 7005
- 9. Blue Detail ..... 3762
- 10. White Linework..... 0015
- 11. Silver Metallic Linework..... 7005
- 12. Light Gray Cover Stitch ..... 0145

\*Fabric Required



## 12806-08 Applique Tile 8

Size Inches:                      Size mm:                      Stitch Count:  
**5.39 X 5.36 in.**    **136.91 X 136.14 mm**    **11802 St.**

- 1. Seam with Matching Bobbin Thread ..... 0020
- 2. Silver Fabric Placement Stitch ..... 0145
- 3. Cut Line and Tackdown ..... 0145
- 4. Light Blue Fabric Placement Stitch ..... 0145
- 5. Cut Line and Tackdown ..... 0145
- 6. White Fabric Placement Stitch ..... 0145
- 7. Cut Line and Tackdown ..... 0145
- 8. Silver Metallic Scallops and Swirls ..... 7005
- 9. Blue Detail ..... 3762
- 10. White Cover Stitch..... 0015
- 11. White Linework..... 0015
- 12. Silver Metallic Linework..... 7005
- 13. Light Gray Cover Stitch ..... 0145



Note: Some designs in this collection may have been created using unique special stitches and/or techniques. To preserve design integrity when rescaling or rotating designs in your software, always rescale or rotate designs using the handles directly on-screen.

\*Fabric Required



## 12806-09 Applique Tile 9

Size Inches:                      Size mm:                      Stitch Count:  
**5.38 X 5.39 in.    136.65 X 136.91 mm    11040 St.**

- 1. Seam with Matching Bobbin Thread ..... 0020
- 2. Silver Fabric Placement Stitch ..... 0145
- 3. Cut Line and Tackdown ..... 0145
- 4. Light Blue Fabric Placement Stitch ..... 0145
- 5. Cut Line and Tackdown ..... 0145
- 6. White Fabric Placement Stitch ..... 0145
- 7. Cut Line and Tackdown ..... 0145
- 8. Silver Metallic Scallops and Swirls ..... 7005
- 9. Blue Detail ..... 3762
- 10. White Cover Stitch ..... 0015
- 11. White Linework ..... 0015
- 12. Silver Metallic Linework ..... 7005
- 13. Light Gray Cover Stitch ..... 0145

\*Fabric Required

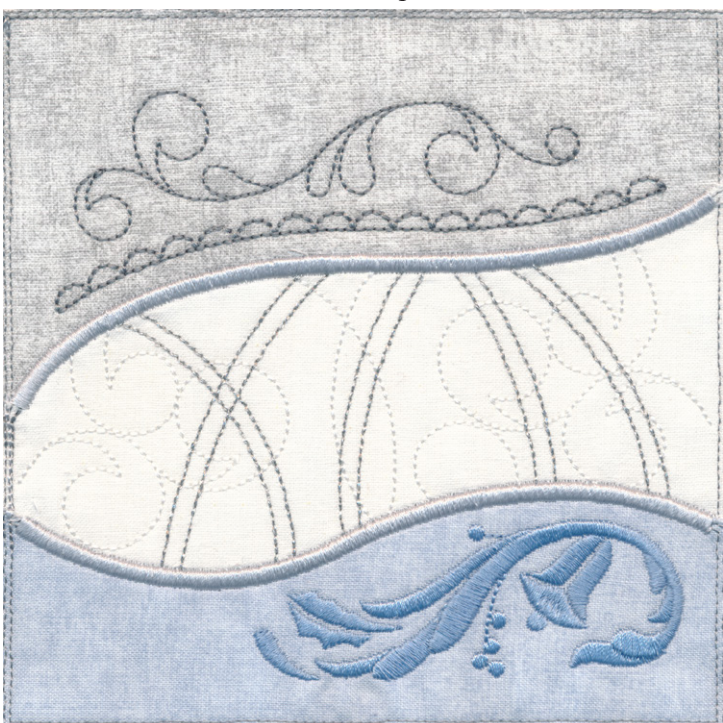

## 12806-10 Applique Tile 10

Size Inches:                      Size mm:                      Stitch Count:  
**5.39 X 5.38 in.    136.91 X 136.65 mm    11097 St.**

- 1. Seam with Matching Bobbin Thread ..... 0020
- 2. Silver Fabric Placement Stitch ..... 0145
- 3. Cut Line and Tackdown ..... 0145
- 4. White Fabric Placement Stitch ..... 0145
- 5. Cut Line and Tackdown ..... 0145
- 6. Light Blue Fabric Placement Stitch ..... 0145
- 7. Cut Line and Tackdown ..... 0145
- 8. Silver Metallic Scallops and Swirls ..... 7005
- 9. Blue Detail ..... 3762
- 10. White Linework ..... 0015
- 11. Silver Metallic Linework ..... 7005
- 12. Light Gray Cover Stitch ..... 0145



Note: Some designs in this collection may have been created using unique special stitches and/or techniques. To preserve design integrity when rescaling or rotating designs in your software, always rescale or rotate designs using the handles directly on-screen.

\*Fabric Required



## 12806-11 Applique Tile 11

Size Inches:                      Size mm:                      Stitch Count:  
**5.39 X 5.38 in.**    **136.91 X 136.65 mm**    **11097 St.**

- 1. Seam with Matching Bobbin Thread ..... 0020
- 2. Silver Fabric Placement Stitch ..... 0145
- 3. Cut Line and Tackdown ..... 0145
- 4. White Fabric Placement Stitch ..... 0145
- 5. Cut Line and Tackdown ..... 0145
- 6. Light Blue Fabric Placement Stitch ..... 0145
- 7. Cut Line and Tackdown ..... 0145
- 8. Silver Metallic Swirls and Scallops ..... 7005
- 9. Blue Detail ..... 3762
- 10. White Linework ..... 0015
- 11. Silver Metallic Linework ..... 7005
- 12. Light Gray Cover Stitch ..... 0145

\*Fabric Required



## 12806-12 Applique Tile 12

Size Inches:                      Size mm:                      Stitch Count:  
**5.39 X 5.39 in.**    **136.91 X 136.91 mm**    **13070 St.**

- 1. Seam with Matching Bobbin Thread ..... 0020
- 2. Light Blue Fabric Placement Stitch ..... 0145
- 3. Cut Line and Tackdown ..... 0145
- 4. White Fabric Placement Stitch ..... 0145
- 5. Cut Line and Tackdown ..... 0145
- 6. Silver Fabric Placement Stitch ..... 0145
- 7. Cut Line and Tackdown ..... 0145
- 8. Silver Metallic Scallops ..... 7005
- 9. Blue Detail ..... 3762
- 10. White Linework ..... 0015
- 11. Silver Metallic Linework ..... 7005
- 12. Light Gray Cover Stitch ..... 0145



Note: Some designs in this collection may have been created using unique special stitches and/or techniques. To preserve design integrity when rescaling or rotating designs in your software, always rescale or rotate designs using the handles directly on-screen.

\*Fabric Required



## 12806-13 Applique Tile 13

Size Inches:                      Size mm:                      Stitch Count:  
**5.39 X 5.38 in.**    **136.91 X 136.65 mm**    **12296 St.**

- 1. Seam with Matching Bobbin Thread ..... 0020
- 2. Light Blue Fabric Placement Stitch ..... 0145
- 3. Cut Line and Tackdown ..... 0145
- 4. White Fabric Placement Stitch ..... 0145
- 5. Cut Line and Tackdown ..... 0145
- 6. Silver Fabric Placement Stitch ..... 0145
- 7. Cut Line and Tackdown ..... 0145
- 8. Silver Metallic Scallops..... 7005
- 9. Blue Detail ..... 3762
- 10. White Linework..... 0015
- 11. Silver Metallic Linework..... 7005
- 12. Light Gray Cover Stitch ..... 0145

\*Fabric Required



## 12806-14 Applique Tile 14

Size Inches:                      Size mm:                      Stitch Count:  
**5.39 X 5.38 in.**    **136.91 X 136.65 mm**    **12295 St.**

- 1. Seam with Matching Bobbin Thread ..... 0020
- 2. Light Blue Fabric Placement Stitch ..... 0145
- 3. Cut Line and Tackdown ..... 0145
- 4. White Fabric Placement Stitch ..... 0145
- 5. Cut Line and Tackdown ..... 0145
- 6. Silver Fabric Placement Stitch ..... 0145
- 7. Cut Line and Tackdown ..... 0145
- 8. Silver Metallic Scallops..... 7005
- 9. Blue Detail ..... 3762
- 10. White Linework..... 0015
- 11. Silver Metallic Linework..... 7005
- 12. Light Gray Cover Stitch ..... 0145



Note: Some designs in this collection may have been created using unique special stitches and/or techniques. To preserve design integrity when rescaling or rotating designs in your software, always rescale or rotate designs using the handles directly on-screen.

\*Fabric Required



## 12806-15 Applique Tile 15

Size Inches:                      Size mm:                      Stitch Count:  
**5.40 X 5.40 in.**    **137.16 X 137.16 mm**    **8591 St.**

- 1. Seam with Matching Bobbin Thread ..... 0020
- 2. Silver Fabric Placement Stitch ..... 0015
- 3. Cut Line and Tackdown ..... 0015
- 4. Light Blue Fabric Placement Stitch ..... 0015
- 5. Cut Line and Tackdown ..... 0015
- 6. Silver Metallic Swirls..... 7005
- 7. Silver Metallic Linework..... 7005
- 8. White Cover Stitch..... 0015
- 9. Blue Detail..... 3762

\*Fabric Required



## 12806-16 Applique Tile 16

Size Inches:                      Size mm:                      Stitch Count:  
**5.40 X 5.40 in.**    **137.16 X 137.16 mm**    **9191 St.**

- 1. Seam with Matching Bobbin Thread ..... 0020
- 2. Silver Fabric Placement Stitch ..... 0015
- 3. Cut Line and Tackdown ..... 0015
- 4. Light Blue Fabric Placement Stitch ..... 0015
- 5. Cut Line and Tackdown ..... 0015
- 6. Silver Metallic Swirls..... 7005
- 7. Silver Metallic Linework..... 7005
- 8. White Cover Stitch..... 0015
- 9. Blue Detail..... 3762



Note: Some designs in this collection may have been created using unique special stitches and/or techniques. To preserve design integrity when rescaling or rotating designs in your software, always rescale or rotate designs using the handles directly on-screen.

\*Fabric Required



## 12806-17 Applique Tile 17

Size Inches:                      Size mm:                      Stitch Count:  
**5.40 X 5.40 in.**    **137.16 X 137.16 mm**    **9470 St.**

- 1. Seam with Matching Bobbin Thread ..... 0020
- 2. Silver Fabric Placement Stitch ..... 0015
- 3. Cut Line and Tackdown ..... 0015
- 4. Light Blue Fabric Placement Stitch ..... 0015
- 5. Cut Line and Tackdown ..... 0015
- 6. Silver Metallic Swirls..... 7005
- 7. Silver Metallic Linework..... 7005
- 8. White Cover Stitch..... 0015
- 9. Blue Detail..... 3762

\*Fabric Required



## 12806-18 Applique Tile 18

Size Inches:                      Size mm:                      Stitch Count:  
**5.40 X 5.40 in.**    **137.16 X 137.16 mm**    **9660 St.**

- 1. Seam with Matching Bobbin Thread ..... 0020
- 2. Silver Fabric Placement Stitch ..... 0015
- 3. Cut Line and Tackdown ..... 0015
- 4. Light Blue Fabric Placement Stitch ..... 0015
- 5. Cut Line and Tackdown ..... 0015
- 6. Silver Metallic Swirls..... 7005
- 7. Silver Metallic Linework..... 7005
- 8. White Cover Stitch..... 0015
- 9. Blue Detail..... 3762



Note: Some designs in this collection may have been created using unique special stitches and/or techniques. To preserve design integrity when rescaling or rotating designs in your software, always rescale or rotate designs using the handles directly on-screen.

\*Fabric Required

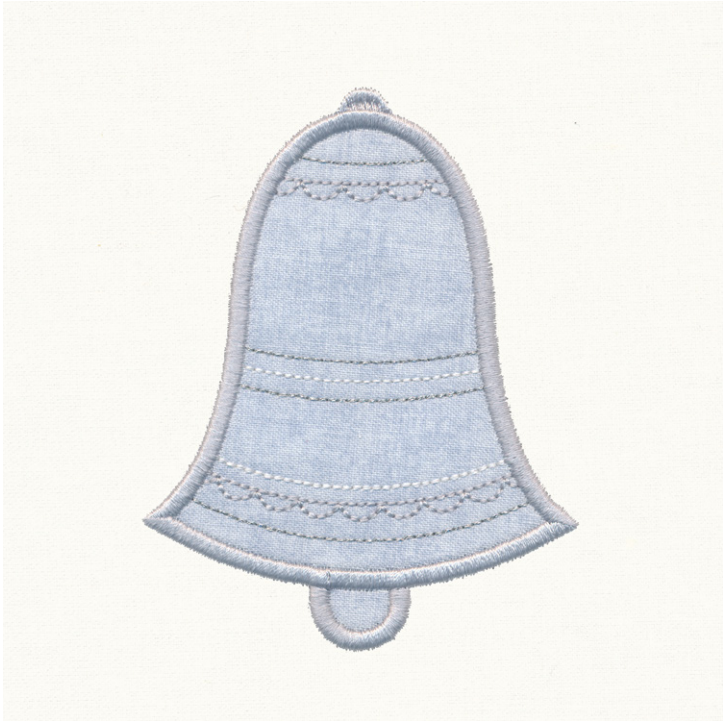

## 12806-19 Bell Applique

Size Inches:                      Size mm:                      Stitch Count:  
**3.11 X 4.02 in.**      **78.99 X 102.11 mm**      **4333 St.**

- 1. Light Blue Fabric Placement Stitch ..... 0145
- 2. Cut Line and Tackdown ..... 0145
- 3. Silver Metallic Detail ..... 7005
- 4. White Linework ..... 0015
- 5. Light Gray Cover Stitch ..... 0145

\*Fabric Required

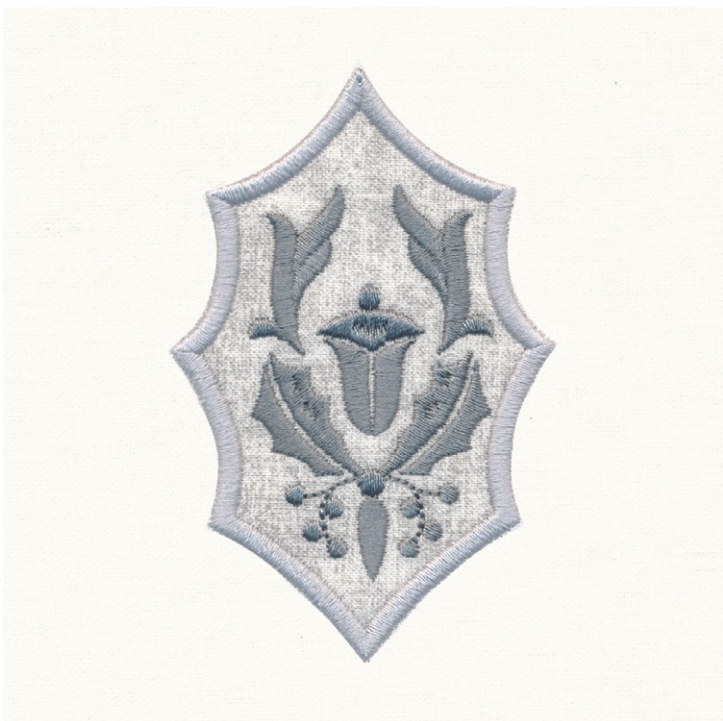

## 12806-20 Holly Applique 1

Size Inches:                      Size mm:                      Stitch Count:  
**2.32 X 3.53 in.**      **58.93 X 89.66 mm**      **5022 St.**

- 1. Silver Fabric Placement Stitch ..... 0145
- 2. Cut Line and Tackdown ..... 0145
- 3. Light Gray Cover Stitch ..... 0145
- 4. Silver Metallic Detail ..... 7005



Note: Some designs in this collection may have been created using unique special stitches and/or techniques. To preserve design integrity when rescaling or rotating designs in your software, always rescale or rotate designs using the handles directly on-screen.

\*Fabric Required

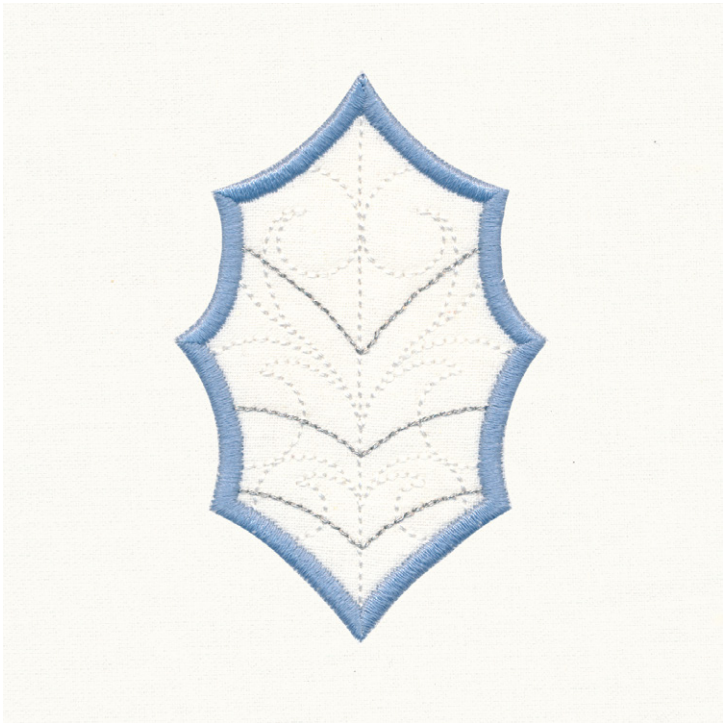

## 12806-21 Holly Applique 2

Size Inches:	Size mm:	Stitch Count:
<b>2.32 X 3.53 in.</b>	<b>58.93 X 89.66 mm</b>	<b>3640 St.</b>

- 1. White Fabric Placement Stitch ..... 0015
- 2. Cut Line and Tackdown ..... 0015
- 3. White Linework ..... 0015
- 4. Silver Metallic Linework ..... 7005
- 5. Blue Cover Stitch ..... 3762

\*Fabric Required

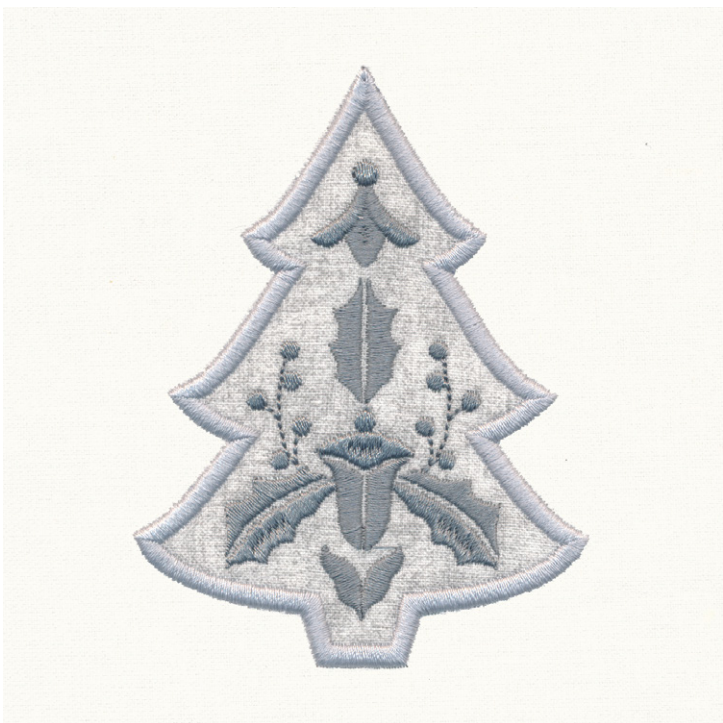

## 12806-22 Tree Applique 1

Size Inches:	Size mm:	Stitch Count:
<b>2.91 X 3.82 in.</b>	<b>73.91 X 97.03 mm</b>	<b>5616 St.</b>

- 1. Silver Fabric Placement Stitch ..... 0145
- 2. Cut Line and Tackdown ..... 0145
- 3. Light Gray Cover Stitch ..... 0145
- 4. Silver Metallic Detail ..... 7005



Note: Some designs in this collection may have been created using unique special stitches and/or techniques. To preserve design integrity when rescaling or rotating designs in your software, always rescale or rotate designs using the handles directly on-screen.

\*Fabric Required

## 12806-23 Tree Applique 2

Size Inches:	Size mm:	Stitch Count:
<b>2.91 X 3.82 in.</b>	<b>73.91 X 97.03 mm</b>	<b>5054 St.</b>

- 1. White Fabric Placement Stitch ..... 0015
- 2. Cut Line and Tackdown ..... 0015
- 3. White Linework ..... 0015
- 4. Silver Metallic Linework ..... 7005
- 5. Blue Cover Stitch ..... 3762

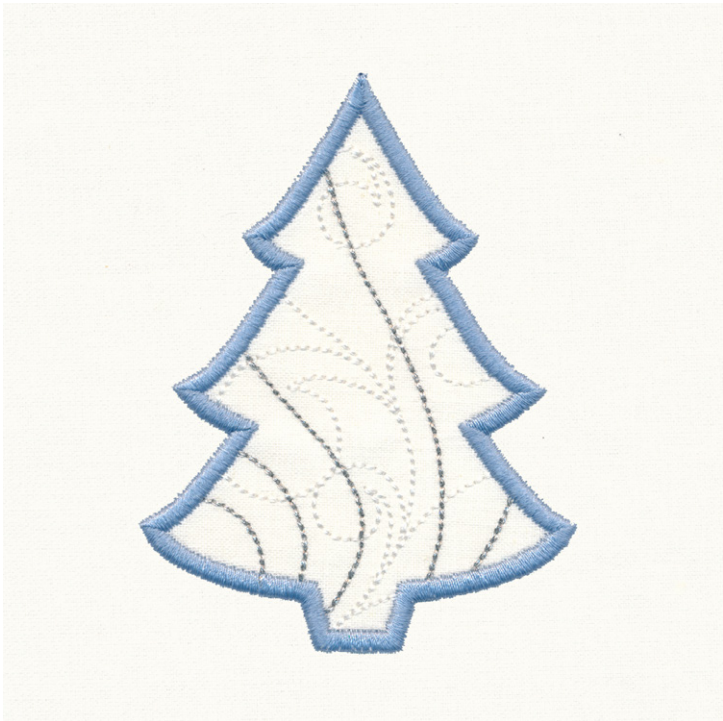

\*Fabric Required

## 12806-24 Ornament Applique 1

Size Inches:	Size mm:	Stitch Count:
<b>2.77 X 3.53 in.</b>	<b>70.36 X 89.66 mm</b>	<b>5999 St.</b>

- 1. Silver Fabric Placement Stitch ..... 0145
- 2. Cut Line and Tackdown ..... 0145
- 3. Light Gray Cover Stitch ..... 0145
- 4. Silver Metallic Detail ..... 7005





Note: Some designs in this collection may have been created using unique special stitches and/or techniques. To preserve design integrity when rescaling or rotating designs in your software, always rescale or rotate designs using the handles directly on-screen.

\*Fabric Required



## 12806-25 Ornament Applique 2

Size Inches:                      Size mm:                      Stitch Count:  
 2.77 X 3.53 in.      70.36 X 89.66 mm      4010 St.

- 1. White Fabric Placement Stitch ..... 0015
- 2. Cut Line and Tackdown ..... 0015
- 3. White Linework ..... 0015
- 4. Silver Metallic Linework ..... 7005
- 5. Blue Cover Stitch ..... 3762

\*Fabric Required



## 12806-26 Snowflake Applique 1

Size Inches:                      Size mm:                      Stitch Count:  
 2.91 X 3.35 in.      73.91 X 85.09 mm      6011 St.

- 1. Silver Fabric Placement Stitch ..... 0145
- 2. Cut Line and Tackdown ..... 0145
- 3. Light Gray Cover Stitch ..... 0145
- 4. Silver Metallic Detail ..... 7005



Note: Some designs in this collection may have been created using unique special stitches and/or techniques. To preserve design integrity when rescaling or rotating designs in your software, always rescale or rotate designs using the handles directly on-screen.

\*Fabric Required

## 12806-27 Snowflake Applique 2

Size Inches:	Size mm:	Stitch Count:
<b>2.90 X 3.35 in.</b>	<b>73.66 X 85.09 mm</b>	<b>5127 St.</b>

- 1. White Fabric Placement Stitch ..... 0015
- 2. Cut Line and Tackdown ..... 0015
- 3. White Linework ..... 0015
- 4. Silver Metallic Linework ..... 7005
- 5. Blue Cover Stitch ..... 3762





# QUILT MATERIALS



## Stabilizer

- OESD Fusible Woven White
- Ultra Clean and Tear
- Ultra Clean and Tear Fusible (optional, use to eliminate spray basting)

## Supplies

- Light grey fabric - 2 and  $\frac{3}{4}$  yds
- White fabric - 2 and  $\frac{1}{3}$  yds
- Blue Fabric - 2 and  $\frac{3}{4}$  yds
- Batting - 44" x 54"
- Backing - 1 and  $\frac{1}{2}$  yds
- Binding -  $\frac{3}{8}$  yd (to cut five 2  $\frac{1}{2}$ " strips)
- Perfect Embroidery Press Cloth
- OESD Bobbin Thread - White
- Bobbin wound with contrasting thread (i.e. black, dark blue, etc.)
- 505 Temporary Spray Adhesive (used for stabilizers and applique fabrics.)

## Isacord Thread Colors

0015 White  
0145 Skylight  
3762 Country Blue  
7005 (SN1) Silver



# SUMMARY



## Silver Bells Quilt

- Requires 4 Designs - 12806-01
- Requires 4 Designs - 12806-02
- Requires 4 Designs - 12806-03
- Requires 4 Designs - 12806-04
- Requires 4 Designs - 12806-05
- Requires 4 Designs - 12806-06
- Requires 4 Designs - 12806-07
- Requires 4 Designs - 12806-08
- Requires 4 Designs - 12806-09
- Requires 4 Designs - 12806-10
- Requires 4 Designs - 12806-11
- Requires 20 Designs - 12806-12
- Requires 4 Designs - 12806-13
- Requires 4 Designs - 12806-14
- Requires 2 Designs - 12806-15
- Requires 2 Designs - 12806-16
- Requires 2 Designs - 12806-17
- Requires 2 Designs - 12806-18

### Final Dimensions:

Approx. 39" x 48"

- The following instructions apply to all of the blocks (i.e. Applique Tiles) for the quilt.

Please follow individual design instructions for color sequences.

**Note:** It is only necessary to use black bobbin thread on Machine Step 1 of each tile. The color for Machine Step 2 of each design may be used for Machine Step 1 to save time and prevent shadow through of the black thread.





# DIAGRAM

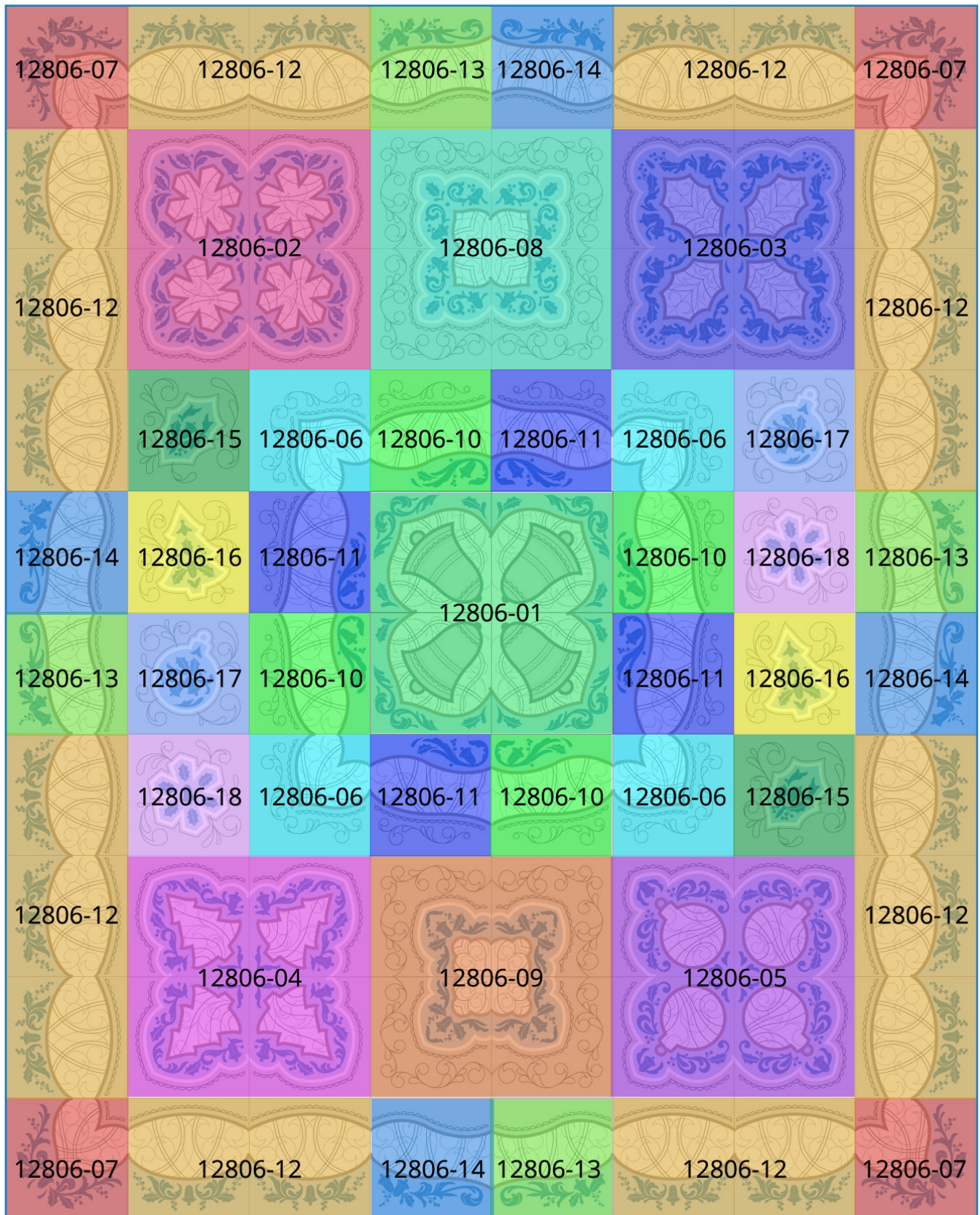

It is a violation of Copyright law to make and distribute copies of electronic designs or artwork. Electronic designs are licensed to the original purchaser for use at one location. ©2019 OESD, LLC. All rights reserved.



# EMBROIDERY



## STEP 1

- Prep all applique fabrics by fusing the Fusible Woven to the back of the fabric with a medium hot iron to eliminate show-through of fabric underneath.

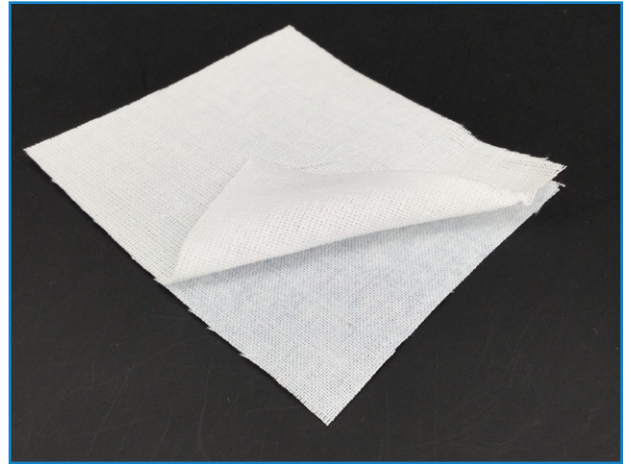

## STEP 2

- Adhere the two pieces of Ultra Clean and Tear together with 505 Temporary Spray Adhesive.
- Hoop the prepared stabilizer.
- Stitch Machine Step 1, Seam Stitch. Use a black bobbin to create the sewing and trimming guide.



## STEP 3

- Change bobbin from black to white.
- Stitch Light Blue Fabric Placement Stitch.

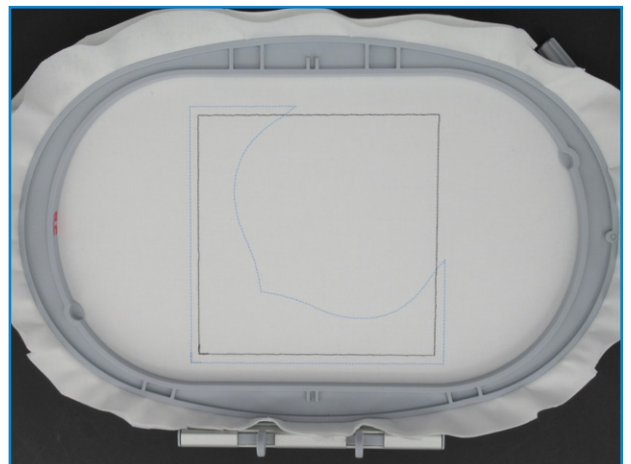

# EMBROIDERY



## STEP 4

- Lightly spray and place Light Blue Fabric and sew Cut Line and Tackdown.



## STEP 5

- Trim the Applique close to the stitching. It is optional whether the outer perimeter is trimmed at this time.



## STEP 6

- Stitch White Fabric Placement Stitch.





# EMBROIDERY



## STEP 7

- Lightly spray and place White Fabric and sew Cut Line and Tackdown.

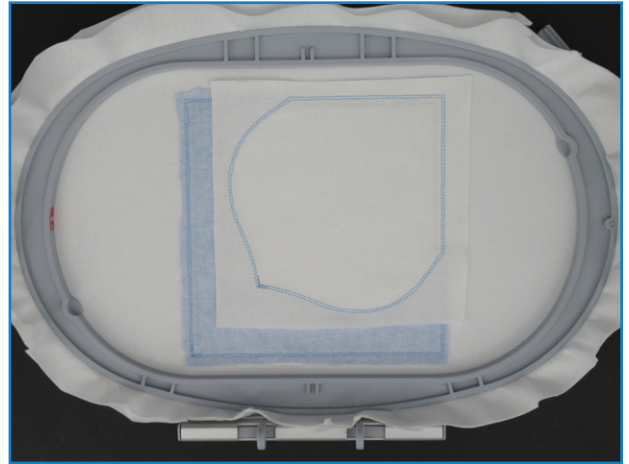

## STEP 8

- Trim the Applique close to the stitching. It is optional whether the outer perimeter is trimmed at this time.



## STEP 9

- Stitch Silver Fabric Placement Stitch.



# EMBROIDERY



## STEP 10

- Lightly spray and place Silver Fabric and sew Cut Line and Tackdown.

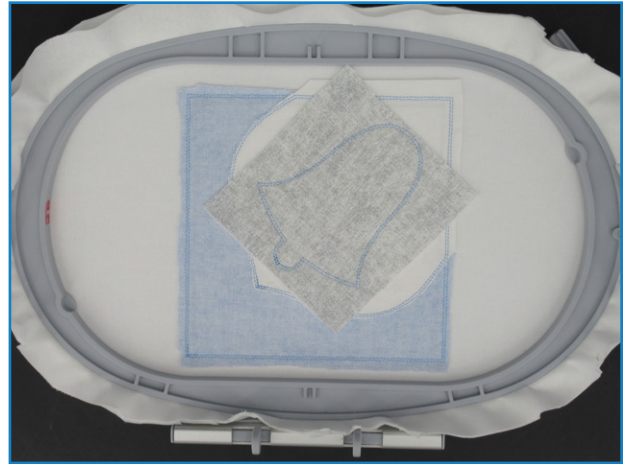

## STEP 11

- Trim the Applique close to the stitching.

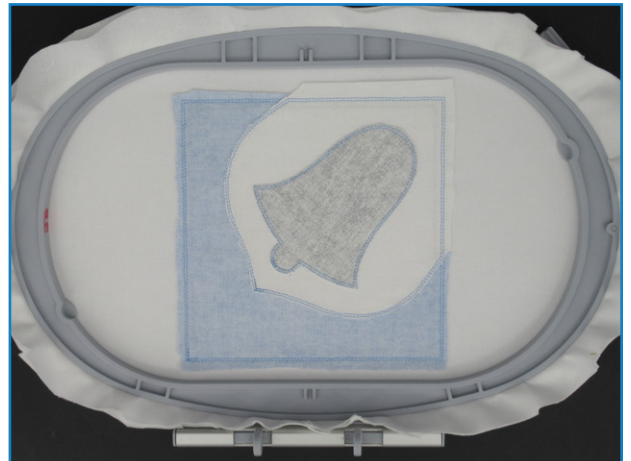

## STEP 12

- Stitch remaining detail and cover stitches.





# INSTRUCTIONS



## STEPS

- After embroidery is complete, trim around edges of block, ¼" away from trim line (the black bobbin stitching), and carefully remove excess stabilizer.
- Assemble the quilt as shown in the diagram. Use a ¼" seam. Press all seams open.
- Layer the backing, batting and quilt top together. Baste all layers with temporary spray adhesive.
- Stitch in the ditch to quilt the layers together. Center the quilt top over the batting and backing. Use a coordinating thread to blend with the quilt top. Use an edgestitch foot to improve accuracy.
- Trim away excess batting and backing to the edge of the quilt top.
- Zig-Zag over the edge of the quilt to seal edges together.
- Stitch on binding as desired.

# POSSIBILITIES

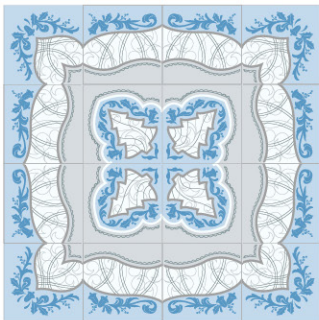
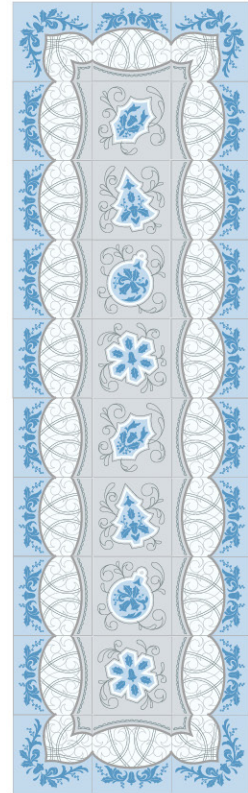
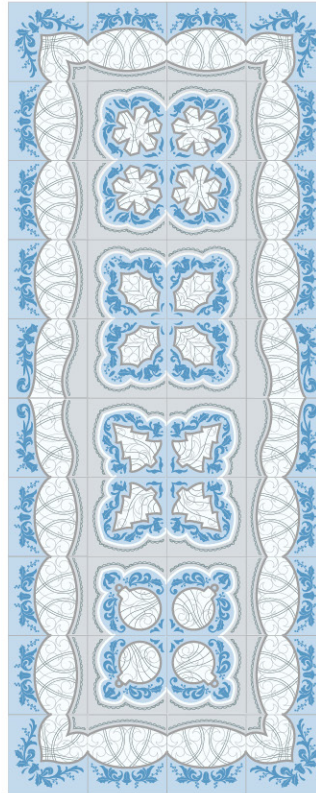
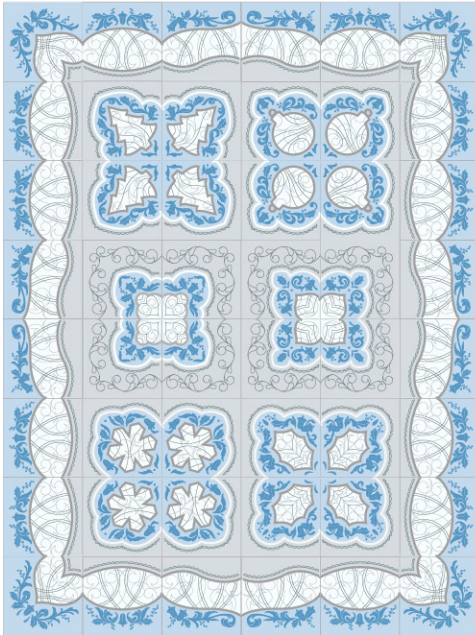
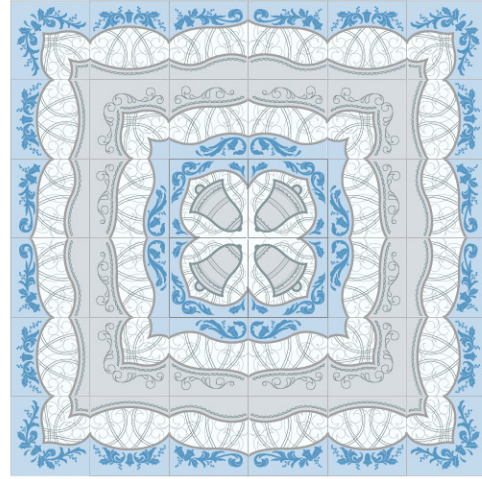
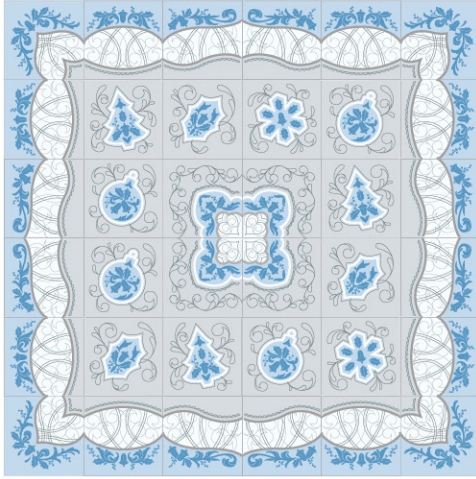



# APPLIQUE PATTERNS



12806-01  
Light Blue Fabric

12806-01  
White Fabric

12806-01  
Silver Fabric

# APPLIQUE PATTERNS



12806-02  
Silver Fabric

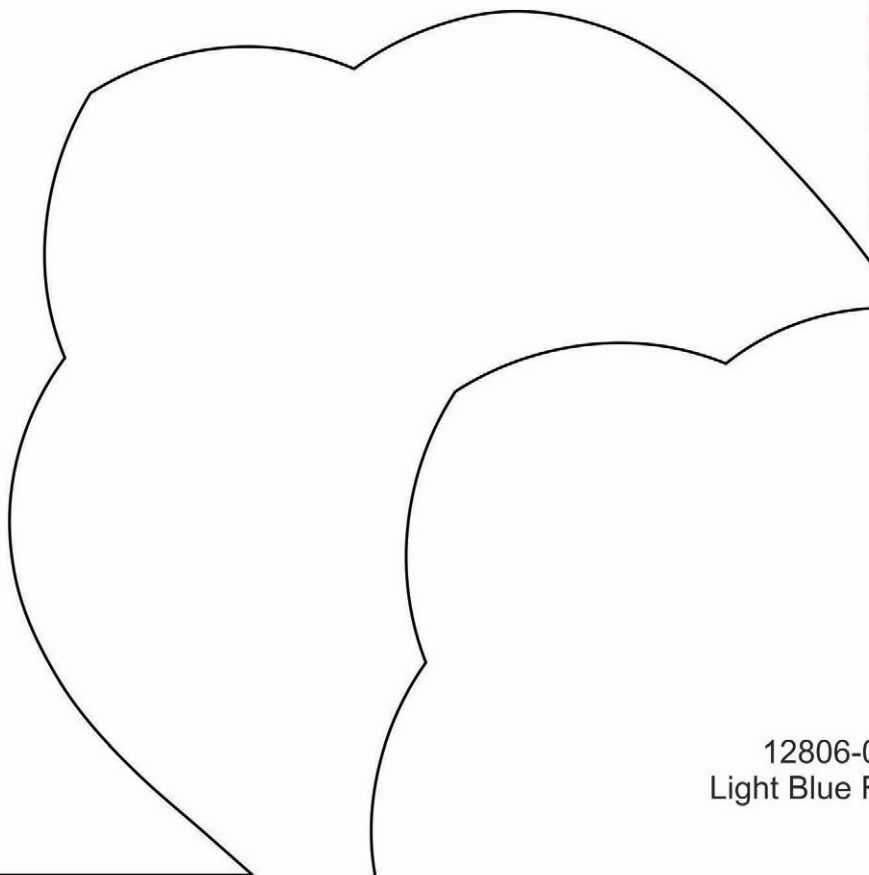

12806-02  
Light Blue Fabric

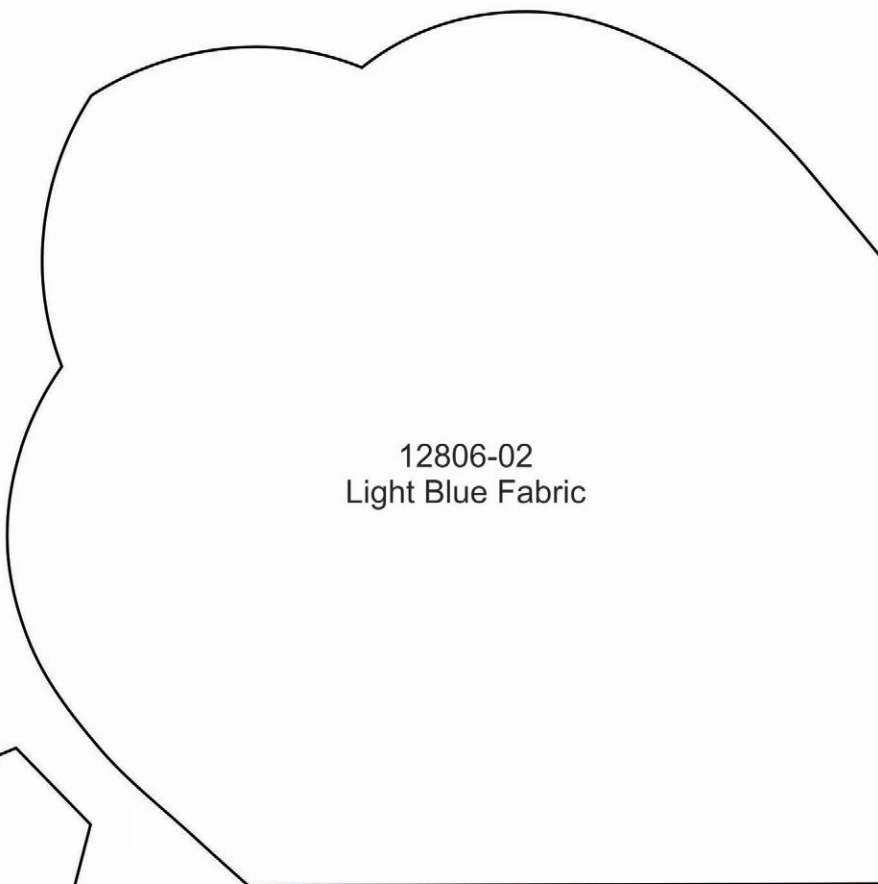

12806-02  
White Fabric

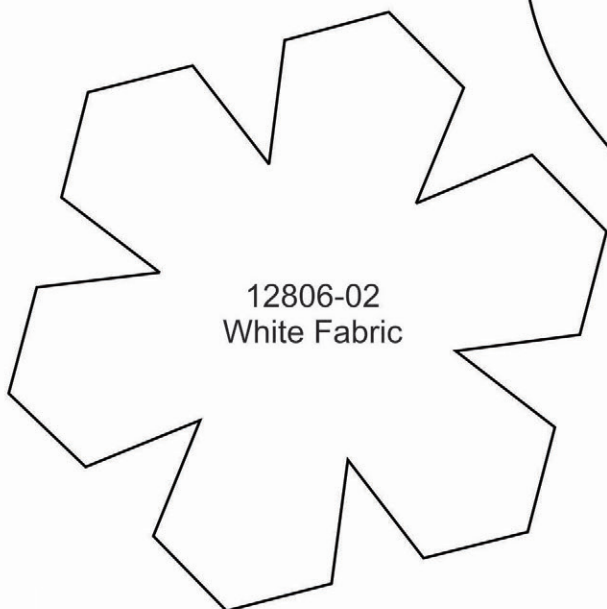



# APPLIQUE PATTERNS



12806-03  
Silver Fabric

12806-03  
Light Blue Fabric

12806-03  
White Fabric

# APPLIQUE PATTERNS



12806-04  
Silver Fabric

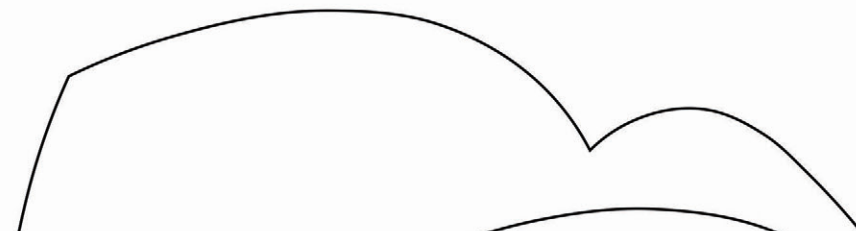

12806-04  
Light Blue Fabric

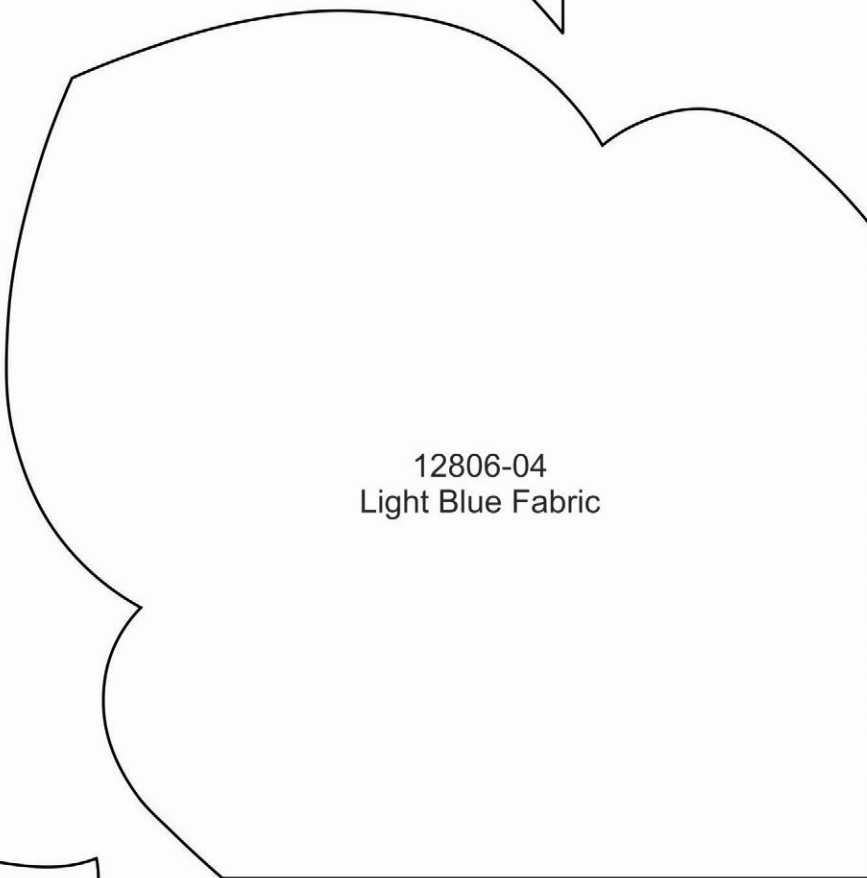

12806-04  
White Fabric

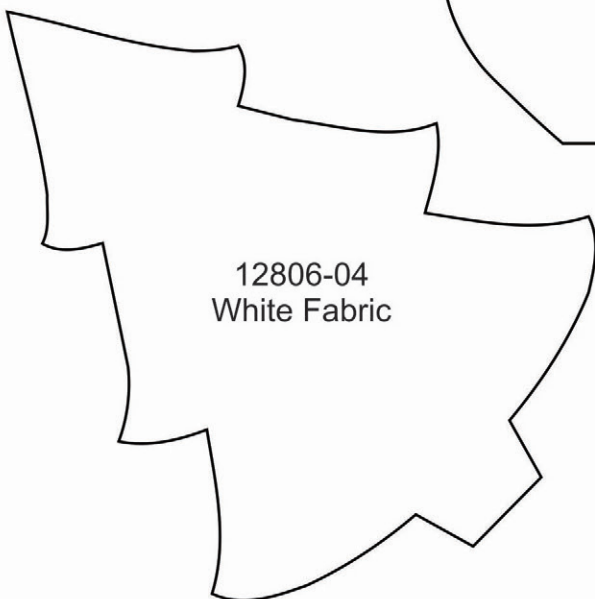



# APPLIQUE PATTERNS



12806-05  
Silver Fabric

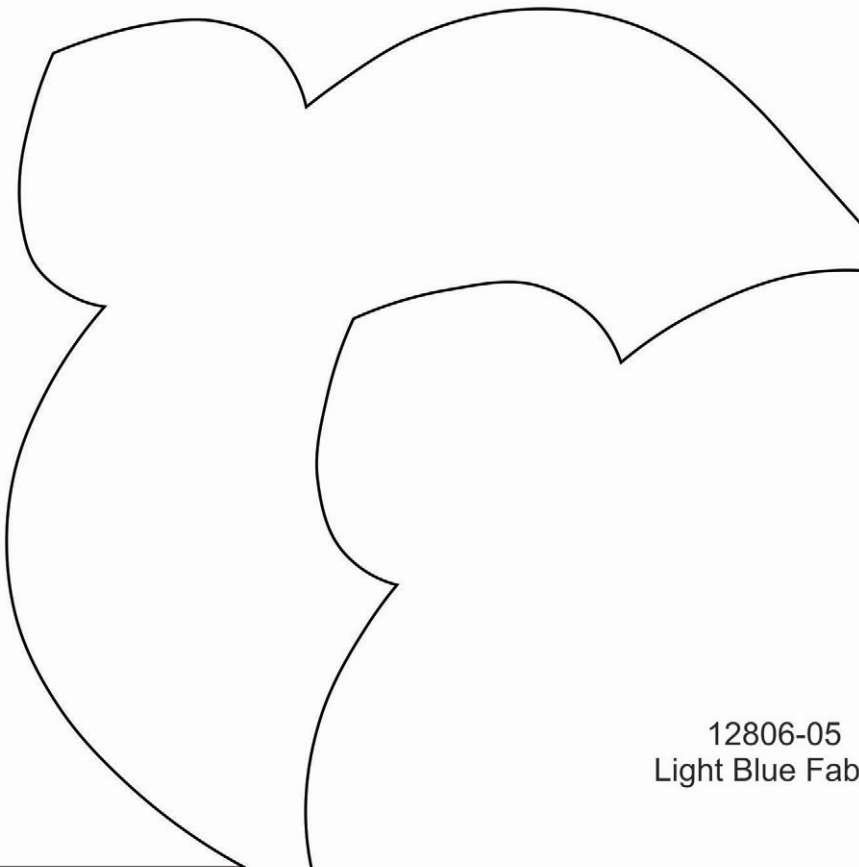

12806-05  
Light Blue Fabric

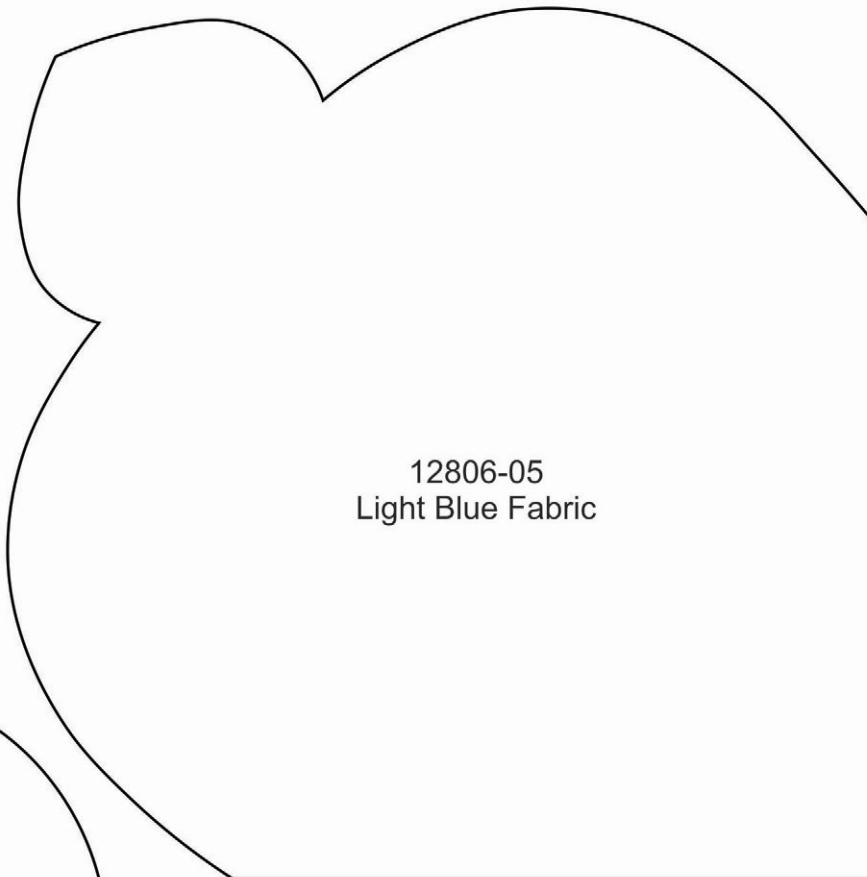

12806-05  
White Fabric

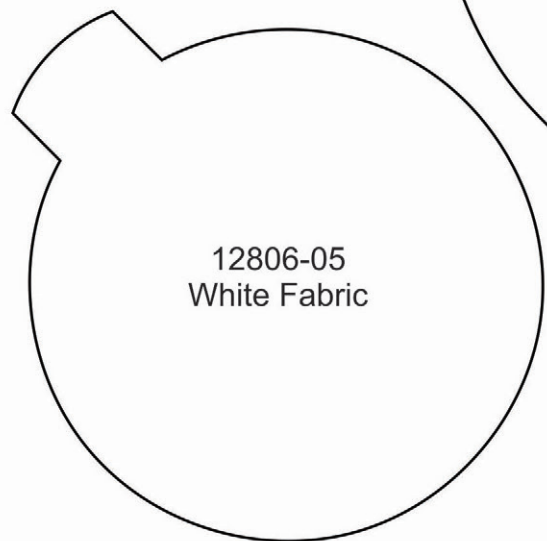

12806-06  
Silver Fabric

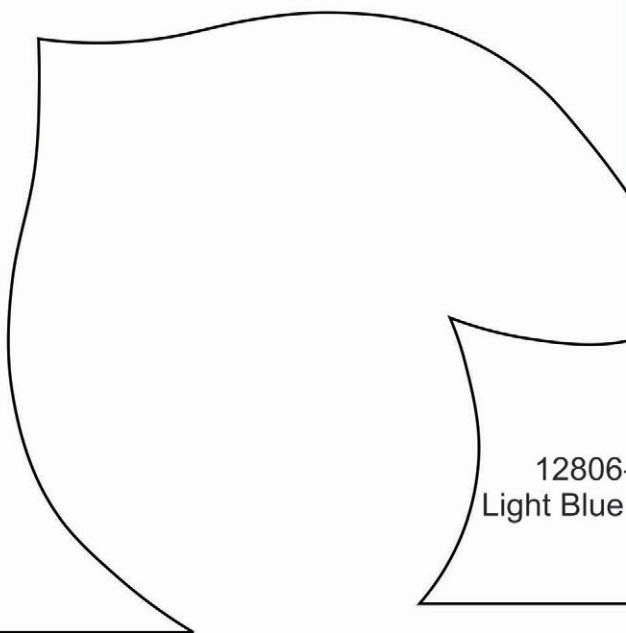

12806-06  
Light Blue Fabric



12806-06  
White Fabric

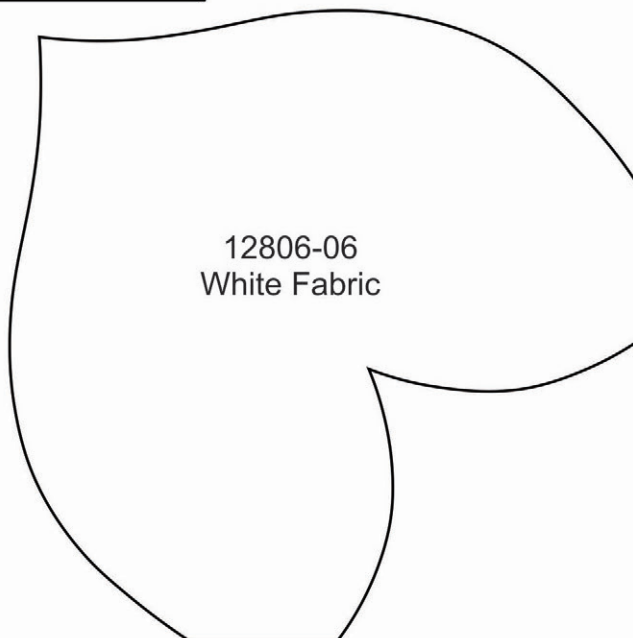



# APPLIQUE PATTERNS



12806-07  
Light Blue Fabric

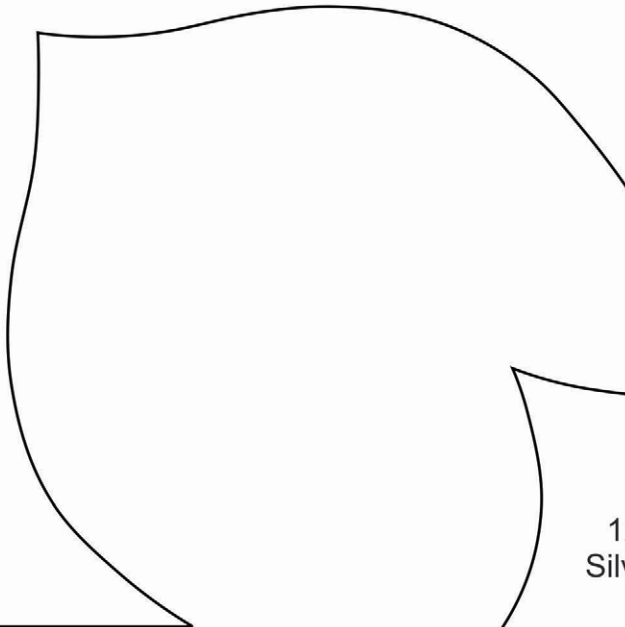

12806-07  
Silver Fabric



12806-07  
White Fabric

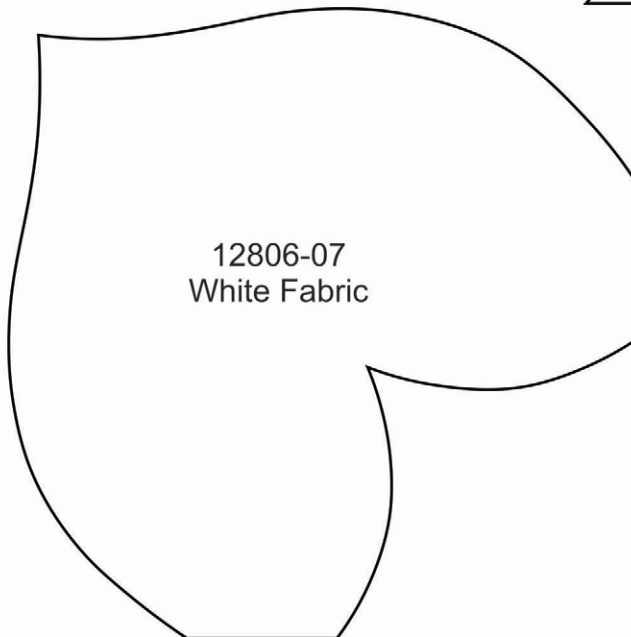

# APPLIQUE PATTERNS



12806-08  
Silver Fabric

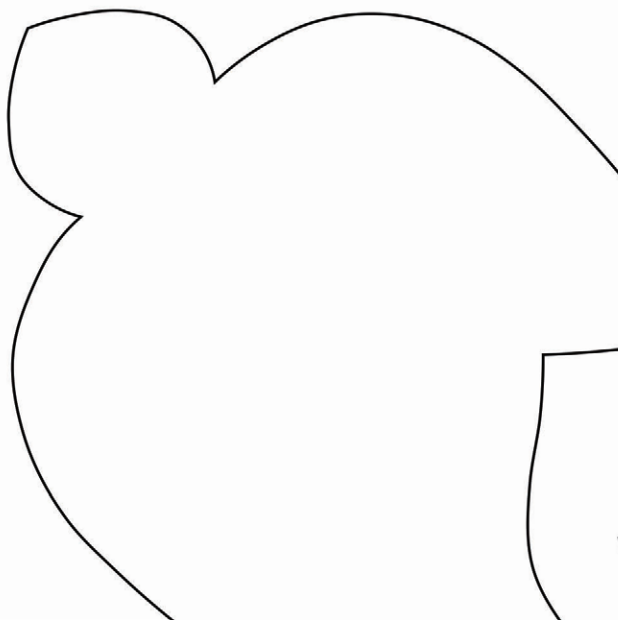

12806-08  
White Fabric

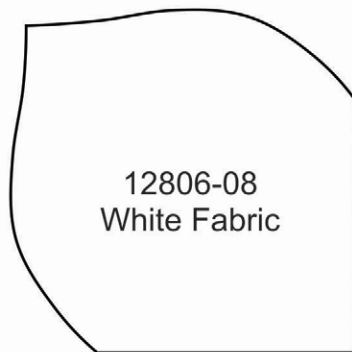

12806-08  
Light Blue Fabric

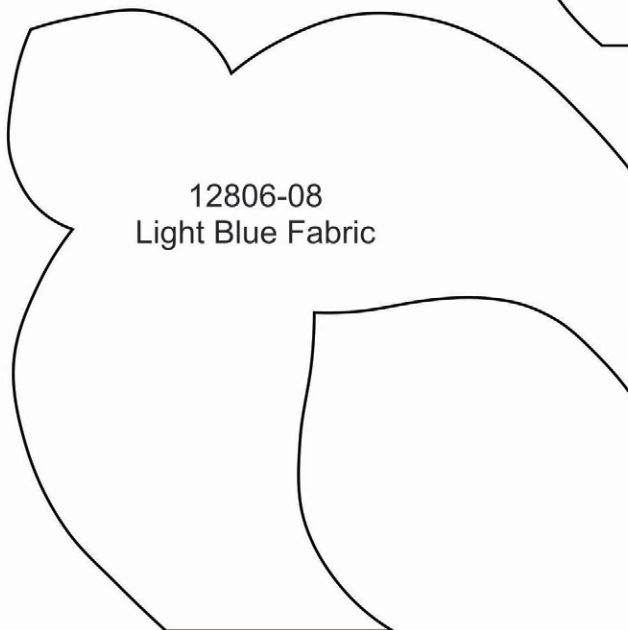



# APPLIQUE PATTERNS



12806-09  
Silver Fabric

12806-09  
White Fabric

12806-09  
Light Blue Fabric

# APPLIQUE PATTERNS



12806-10  
Silver Fabric

12806-10  
White Fabric

12806-10  
Light Blue Fabric



12806-11  
Silver Fabric

12806-11  
White Fabric

12806-11  
Light Blue Fabric

# APPLIQUE PATTERNS



12806-12  
Light Blue Fabric

12806-12  
White Fabric

12806-12  
Silver Fabric

# APPLIQUE PATTERNS



12806-13  
Light Blue Fabric

12806-13  
White Fabric

12806-13  
Silver Fabric



12806-14  
Light Blue Fabric

12806-14  
White Fabric

12806-14  
Silver Fabric

12806-15  
Silver Fabric

12806-15  
Light Blue Fabric

12806-16  
Silver Fabric

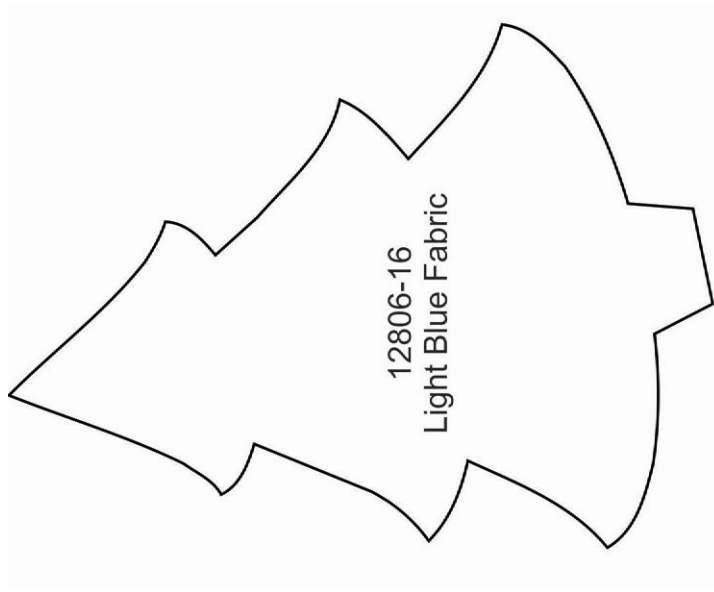



12806-17  
Silver Fabric

12806-17  
Light Blue Fabric

12806-18  
Silver Fabric

12806-18  
Light Blue Fabric

# APPLIQUE PATTERNS

