

FREESTANDING HAUNTED MANSION



1

Design

Fits hoop sizes 6" x 10" and larger

THREAD LIST



Isacord Thread Colors

- 0020 Black
- 0108 Cobblestone
- 0150 Mystik Grey

DESIGNS

Note: Some designs in this collection may have been created using unique special stitches and/or techniques. To preserve design integrity when rescaling or rotating designs in your software, always rescale or rotate designs using the handles directly on-screen.

*Fabric Required



12830-01 Tower Wall 1 FSA

Size Inches:	Size mm:	Stitch Count:
8.35 X 2.82 in.	212.1 X 71.6 mm	16589 St.

- 1. Black Fabric Placement Stitch..... 0020
- 2. Cut Line and Tackdown..... 0020
- 3. Lace and Cover Stitch..... 0020

Note: Some designs in this collection may have been created using unique special stitches and/or techniques. To preserve design integrity when rescaling or rotating designs in your software, always rescale or rotate designs using the handles directly on-screen.

***Fabric Required**

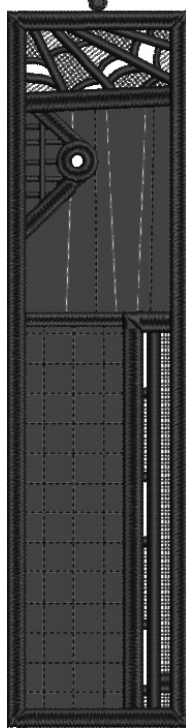

12830-02 Tower Wall 2 FSA

Size Inches: Size mm: Stitch Count:
8.35 X 2.05 in. 212.1 X 52.1 mm 18770 St.

- 1. Black Fabric Placement Stitch..... 0108
- 2. Cut Line and Tackdown 0108
- 3. Gray Linework 0108
- 4. Lace and Cover Stitch 0020

***Fabric Required**

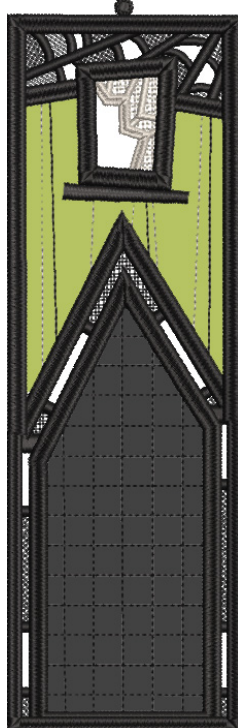

12830-03 Tower Wall 3 FSA

Size Inches: Size mm: Stitch Count:
8.36 X 2.67 in. 212.3 X 67.8 mm 25700 St.

- 1. Black Fabric Placement Stitch..... 0108
- 2. Cut Line and Tackdown 0108
- 3. Green Fabric Placement Stitch 0108
- 4. Cut Line and Tackdown 0108
- 5. Gray Linework 0108
- 6. Window Lace 0150
- 7. Lace and Cover Stitch 0020

Note: Some designs in this collection may have been created using unique special stitches and/or techniques. To preserve design integrity when rescaling or rotating designs in your software, always rescale or rotate designs using the handles directly on-screen.

***Fabric Required**

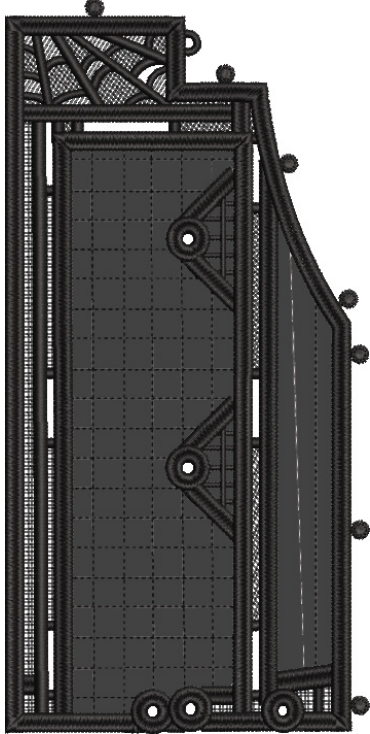

12830-04 Tower Wall 4 FSA

Size Inches: Size mm: Stitch Count:
8.38 X 4.14 in. 212.9 X 105.2 mm 36424 St.

- 1. Black Fabric Placement Stitch..... 0108
- 2. Cut Line and Tackdown 0108
- 3. Black Fabric Placement Stitch..... 0108
- 4. Cut Line and Tackdown 0108
- 5. Gray Linework 0108
- 6. Lace and Cover Stitch 0020

***Fabric Required**

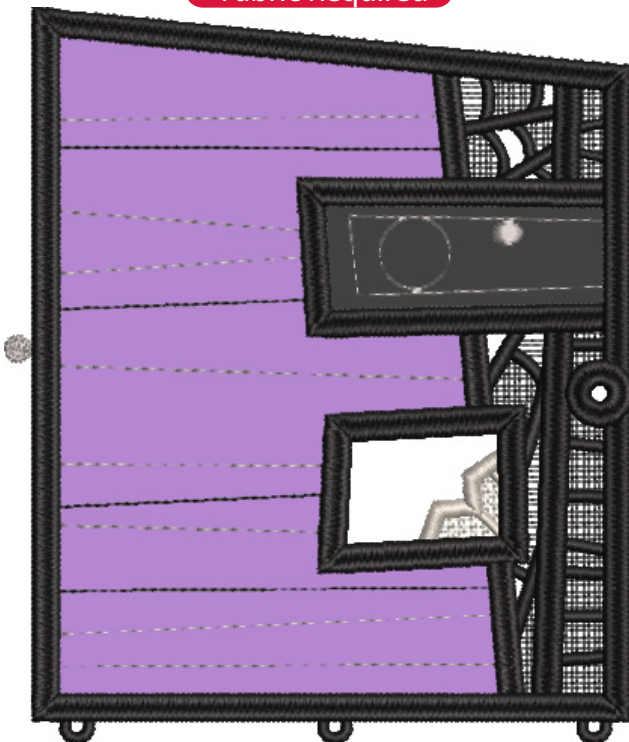

12830-05 Back Wall 1 FSA

Size Inches: Size mm: Stitch Count:
5.70 X 4.87 in. 144.8 X 123.7 mm 21256 St.

- 1. Purple Fabric Placement Stitch 0108
- 2. Cut Line and Tackdown 0108
- 3. Black Fabric Placement Stitch..... 0108
- 4. Cut Line and Tackdown 0108
- 5. Gray Linework and Buttonette..... 0108
- 6. Window Detail 0150
- 7. Lace and Cover Stitch 0020

Note: Some designs in this collection may have been created using unique special stitches and/or techniques. To preserve design integrity when rescaling or rotating designs in your software, always rescale or rotate designs using the handles directly on-screen.

***Fabric Required**



12830-06 Side Wall 1 FSA

Size Inches: Size mm: Stitch Count:
7.60 X 3.56 in. 193.0 X 90.4 mm 24581 St.

- 1. Orange Fabric Placement Stitch 0108
- 2. Cut Line and Tackdown 0108
- 3. Gray Linework 0108
- 4. Window Detail 0150
- 5. Lace and Cover Stitch 0020

***Fabric Required**

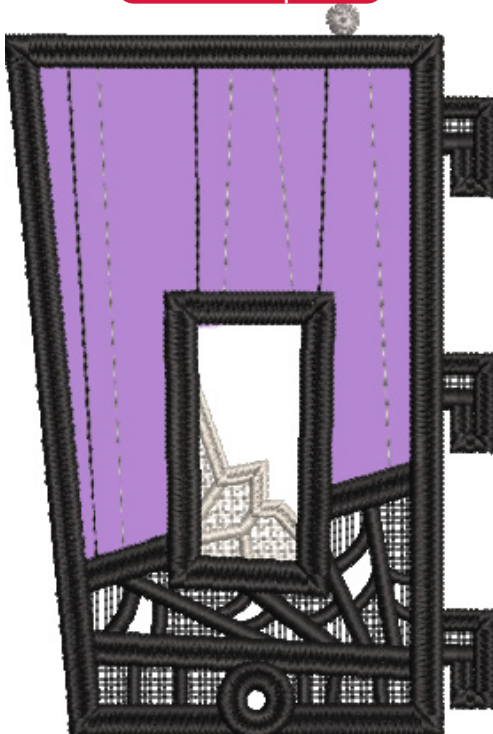

12830-07 Front Wall 1 FSA

Size Inches: Size mm: Stitch Count:
4.85 X 3.23 in. 123.2 X 82.0 mm 15223 St.

- 1. Purple Fabric Placement Stitch 0108
- 2. Cut Line and Tackdown 0108
- 3. Gray Linework and Buttonette 0108
- 4. Window Detail 0150
- 5. Lace and Cover Stitch 0020

Note: Some designs in this collection may have been created using unique special stitches and/or techniques. To preserve design integrity when rescaling or rotating designs in your software, always rescale or rotate designs using the handles directly on-screen.

***Fabric Required**

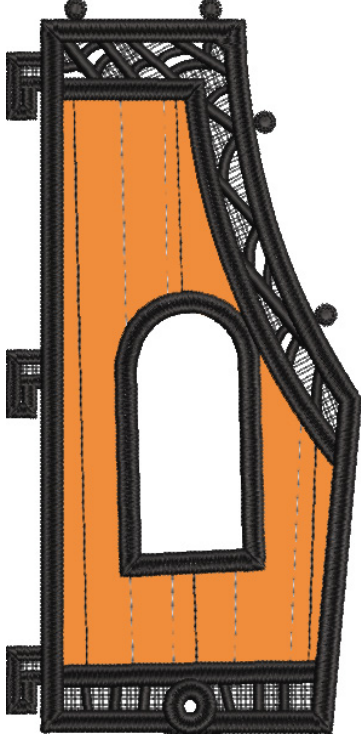

12830-08 Front Wall 2 FSA

Size Inches:	Size mm:	Stitch Count:
7.11 X 3.43 in.	180.6 X 87.1 mm	20766 St.

- 1. Orange Fabric Placement Stitch 0108
- 2. Cut Line and Tackdown 0108
- 3. Gray Linework 0108
- 4. Lace and Cover Stitch 0020

***Fabric Required**



12830-09 Side Wall 2 FSA

Size Inches:	Size mm:	Stitch Count:
3.48 X 2.34 in.	88.4 X 59.4 mm	9560 St.

- 1. Black Fabric Placement Stitch..... 0108
- 2. Cut Line and Tackdown 0108
- 3. Gray Linework and Buttonette 0108
- 4. Lace and Cover Stitch 0020

Note: Some designs in this collection may have been created using unique special stitches and/or techniques. To preserve design integrity when rescaling or rotating designs in your software, always rescale or rotate designs using the handles directly on-screen.

***Fabric Required**

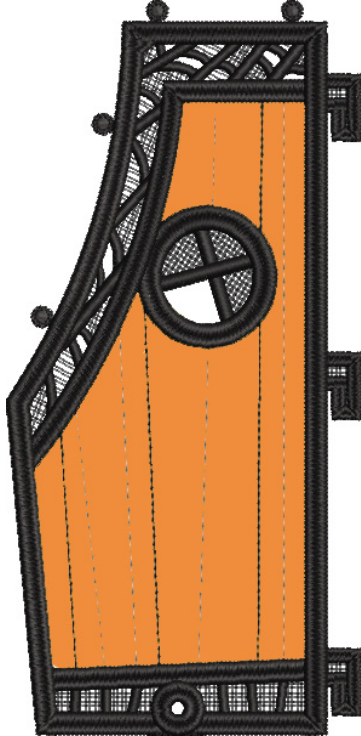

12830-10 Back Wall 2 FSA

Size Inches: Size mm: Stitch Count:
7.11 X 3.43 in. 180.6 X 87.1 mm 21169 St.

- 1. Orange Fabric Placement Stitch 0108
- 2. Cut Line and Tackdown 0108
- 3. Gray Linework 0108
- 4. Lace and Cover Stitch 0020

***Fabric Required**

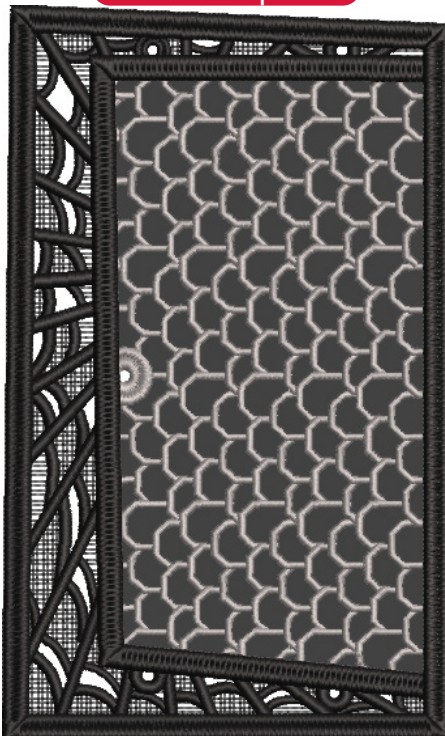

12830-11 Front Roof 1 FSA

Size Inches: Size mm: Stitch Count:
6.60 X 4.02 in. 167.6 X 102.1 mm 40531 St.

- 1. Black Fabric Placement Stitch..... 0108
- 2. Cut Line and Tackdown 0108
- 3. Gray Roof Detail 0108
- 4. Lace and Cover Stitch 0020

Note: Some designs in this collection may have been created using unique special stitches and/or techniques. To preserve design integrity when rescaling or rotating designs in your software, always rescale or rotate designs using the handles directly on-screen.

***Fabric Required**

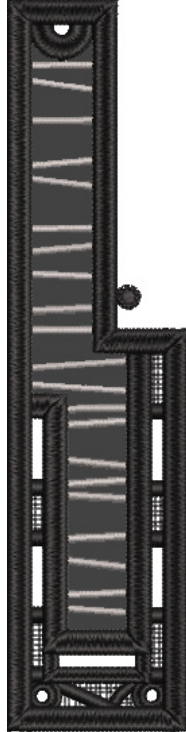

12830-12 Roof Top FSA

Size Inches: Size mm: Stitch Count:
6.40 X 1.58 in. 162.6 X 40.1 mm 12855 St.

- 1. Black Fabric Placement Stitch..... 0108
- 2. Cut Line and Tackdown 0108
- 3. Gray Roof Detail..... 0108
- 4. Lace and Cover Stitch 0020

***Fabric Required**



12830-13 Back Roof FSA

Size Inches: Size mm: Stitch Count:
3.83 X 3.75 in. 97.3 X 95.3 mm 22900 St.

- 1. Black Fabric Placement Stitch..... 0108
- 2. Cut Line and Tackdown 0108
- 3. Gray Roof Detail..... 0108
- 4. Lace and Cover Stitch 0020

Note: Some designs in this collection may have been created using unique special stitches and/or techniques. To preserve design integrity when rescaling or rotating designs in your software, always rescale or rotate designs using the handles directly on-screen.



12830-14 Boards FSL

Size Inches: Size mm: Stitch Count:
4.08 X 2.32 in. 103.6 X 58.9 mm 10037 St.

- 1. Single Color Design..... 0020

***Fabric Required**

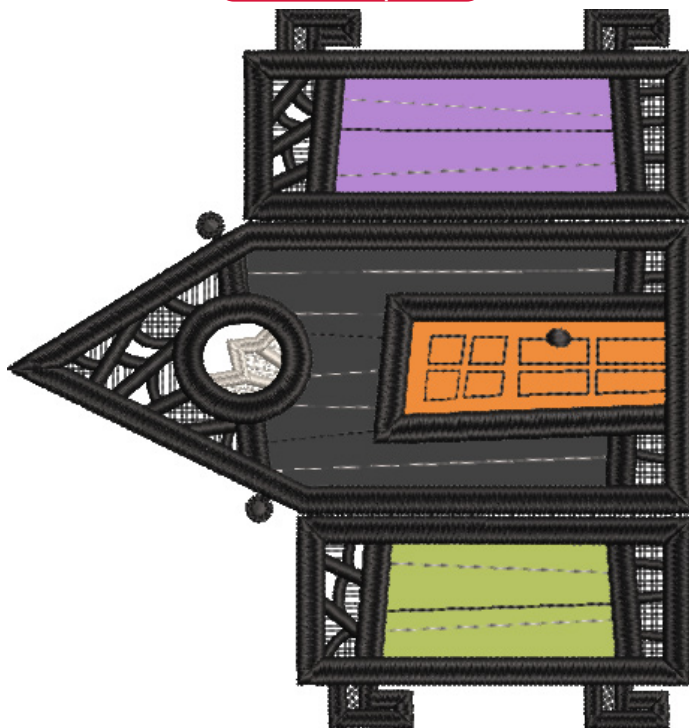

12830-15 Front Door Walls FSA

Size Inches: Size mm: Stitch Count:
5.62 X 5.36 in. 142.7 X 136.1 mm 27829 St.

- 1. Purple Fabric Placement Stitch 0108
- 2. Cut Line and Tackdown 0108
- 3. Black Fabric Placement Stitch..... 0108
- 4. Cut Line and Tackdown 0108
- 5. Green Fabric Placement Stitch 0108
- 6. Cut Line and Tackdown 0108
- 7. Orange Fabric Placement Stitch 0108
- 8. Cut Line and Tackdown 0108
- 9. Gray Linework 0108
- 10. Window Detail 0150
- 11. Lace and Cover Stitch 0020

Note: Some designs in this collection may have been created using unique special stitches and/or techniques. To preserve design integrity when rescaling or rotating designs in your software, always rescale or rotate designs using the handles directly on-screen.

***Fabric Required**

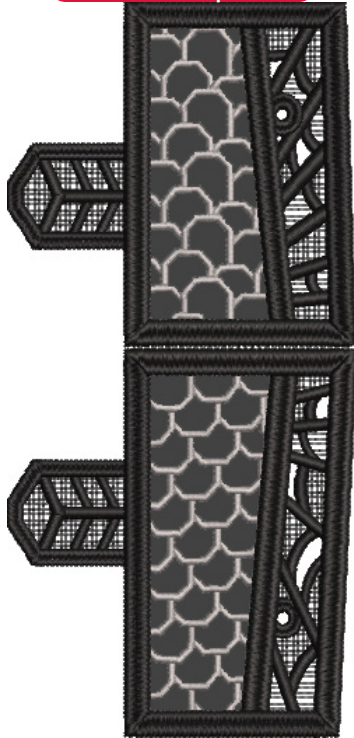

12830-16 Front Door Roof FSA

Size Inches: Size mm: Stitch Count:
6.16 X 2.93 in. 156.5 X 74.4 mm 24645 St.

- 1. Black Fabric Placement Stitch..... 0108
- 2. Cut Line and Tackdown 0108
- 3. Black Fabric Placement Stitch..... 0108
- 4. Cut Line and Tackdown 0108
- 5. Gray Roof Detail..... 0108
- 6. Black..... 0020

***Fabric Required**



12830-17 Side Roof FSA

Size Inches: Size mm: Stitch Count:
7.71 X 3.37 in. 195.8 X 85.6 mm 40734 St.

- 1. Black Fabric Placement Stitch..... 0108
- 2. Cut Line and Tackdown 0108
- 3. Black Fabric Placement Stitch..... 0108
- 4. Cut Line and Tackdown 0108
- 5. Gray Roof Detail..... 0108
- 6. Lace and Cover Stitch 0020

Note: Some designs in this collection may have been created using unique special stitches and/or techniques. To preserve design integrity when rescaling or rotating designs in your software, always rescale or rotate designs using the handles directly on-screen.

12830-18 Tower Topper FSL

Size Inches: Size mm: Stitch Count:
2.42 X 3.00 in. 61.5 X 76.2 mm 17404 St.

- 1. Single Color Design..... 0020

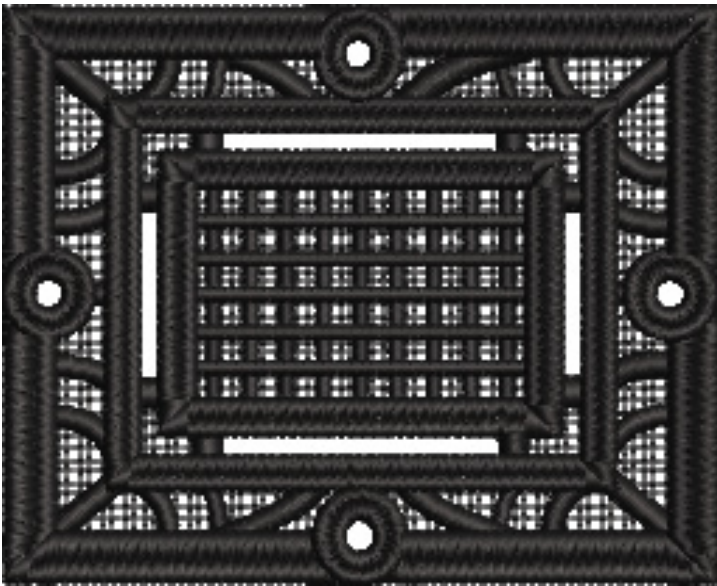

***Fabric Required**

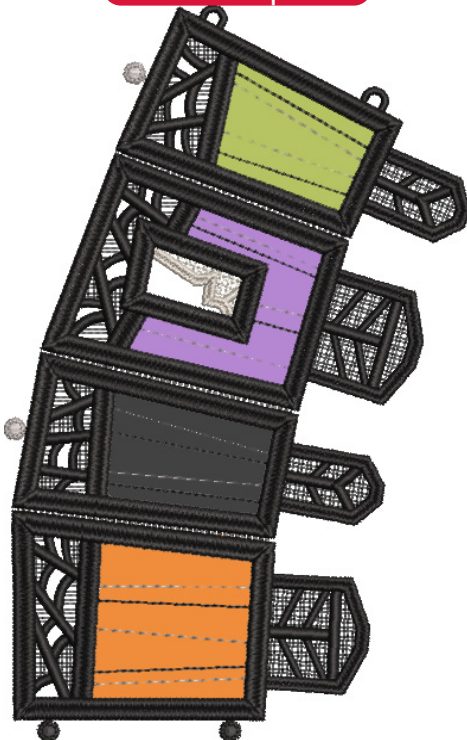

12830-19 Cupola Walls FSA

Size Inches: Size mm: Stitch Count:
7.25 X 4.59 in. 184.2 X 116.6 mm 32571 St.

- 1. Orange Fabric Placement Stitch 0108
- 2. Cut Line and Tackdown 0108
- 3. Black Fabric Placement Stitch..... 0108
- 4. Cut Line and Tackdown 0108
- 5. Purple Fabric Placement Stitch 0108
- 6. Cut Line and Tackdown 0108
- 7. Green Fabric Placement Stitch 0108
- 8. Cut Line and Tackdown 0108
- 9. Gray Buttonettes and Linework 0108
- 10. Window Detail 0150
- 11. Lace and Cover Stitch 0020

Note: Some designs in this collection may have been created using unique special stitches and/or techniques. To preserve design integrity when rescaling or rotating designs in your software, always rescale or rotate designs using the handles directly on-screen.

***Fabric Required**



12830-20 Cupola Roof FSA

Size Inches: Size mm: Stitch Count:
5.71 X 5.28 in. 145.0 X 134.1 mm 27782 St.

- 1. Black Fabric Placement Stitch..... 0108
- 2. Cut Line and Tackdown 0108
- 3. Black Fabric Placement Stitch..... 0108
- 4. Cut Line and Tackdown 0108
- 5. Black Fabric Placement Stitch..... 0108
- 6. Cut Line and Tackdown 0108
- 7. Black Fabric Placement Stitch..... 0108
- 8. Cut Line and Tackdown 0108
- 9. Gray Roof Detail..... 0108
- 10. Lace and Cover Stitch 0020

***Fabric Required**

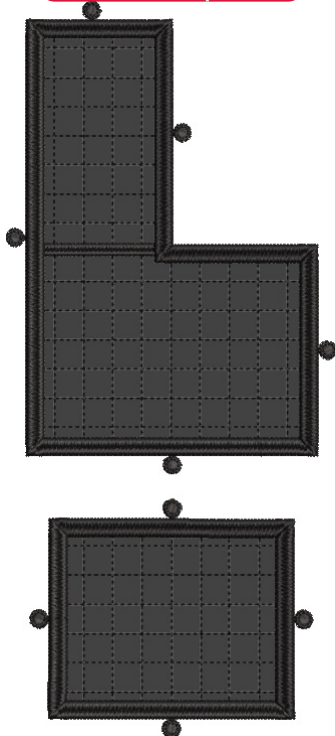

12830-21 Floors FSA

Size Inches: Size mm: Stitch Count:
6.13 X 4.93 in. 155.7 X 125.2 mm 14431 St.

- 1. Black Fabric Placement Stitch..... 0020
- 2. Cut Line and Tackdown 0020
- 3. Black Fabric Placement Stitch..... 0020
- 4. Cut Line and Tackdown 0020
- 5. Lace and Cover Stitch 0020

Note: Some designs in this collection may have been created using unique special stitches and/or techniques. To preserve design integrity when rescaling or rotating designs in your software, always rescale or rotate designs using the handles directly on-screen.

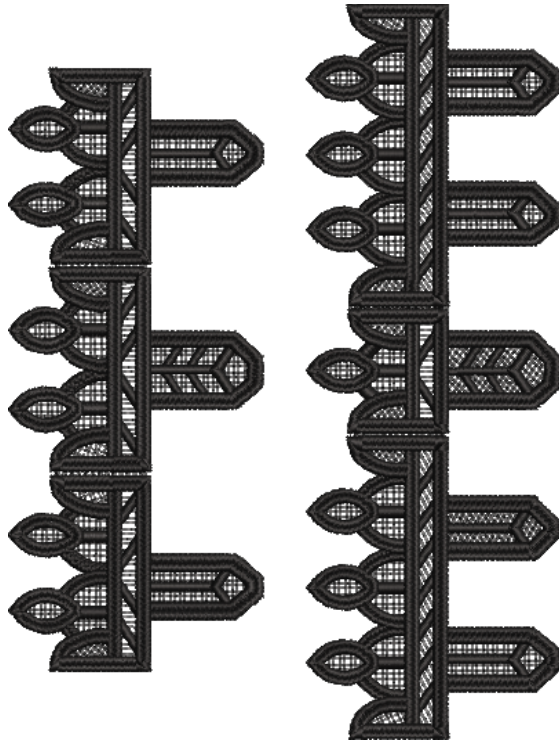

12830-22 Iron Cresting FSL

Size Inches: 6.24 X 4.69 in. Size mm: 158.5 X 119.1 mm Stitch Count: 41893 St.

- 1. Single Color Design..... 0020

***Fabric Required**

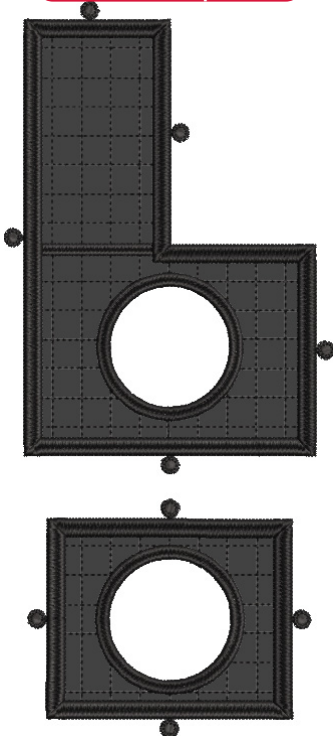

12830-23 Tealight Floors FSA

Size Inches: 6.13 X 4.87 in. Size mm: 155.7 X 123.7 mm Stitch Count: 17551 St.

- 1. Black Fabric Placement..... 0020
- 2. Cut Line and Tackdown 0020
- 3. Black Fabric Placement..... 0020
- 4. Cut Line and Tackdown 0020
- 5. Lace and Cover Stitch 0020

Stabilizer

- AquaMesh WashAway
- BadgeMaster WashAway
- StabilStick CutAway

Supplies

- Alligator clamps, tweezers, hemostats, stiletto or a tiny crochet hook
- Expert Embroidery Tape TearAway
- Perfect Embroidery Press Cloth (recommended)
- Optional: Button Clips

Isacord

- 0020
- 0108
- 0150
- Note: Match bobbin thread to upper thread

Fabric

- 1 fat quarter each of the following colors in cotton
 - Black
 - Gray (**Note:** NOT required, but used in project instructions for roof sections)
 - Green
 - Orange
 - Purple

NOTE

- The project includes freestanding applique designs and freestanding lace designs. All applique designs are stitched the same as shown in the instructions. All designs are stitched with matching thread in the top and bobbin, with one piece of AquaMesh and one piece of BadgeMaster in the hoop.

STEP 1

- For each applique, cut a piece of fabric slightly larger than the placement stitch. Peel the paper from the StabilStick and apply 2 pieces to the back of each applique piece. The stabilizer acts as a stiffener for the design and stays in the project.

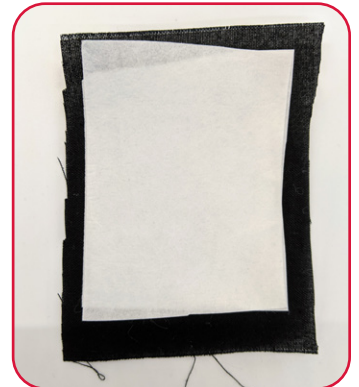
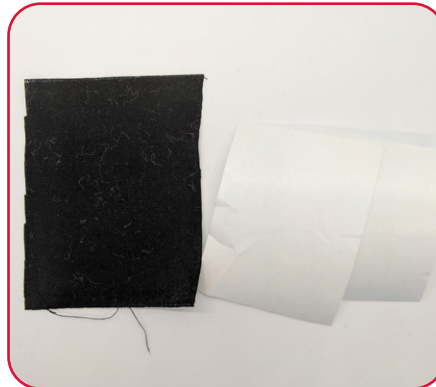

STEP 2

- Hoop 1 piece of AquaMesh and 1 piece of BadgeMaster for each design.



STEP 3

- Stitch Color 1, the Placement Stitch.
- Prep the applique fabric as described above.

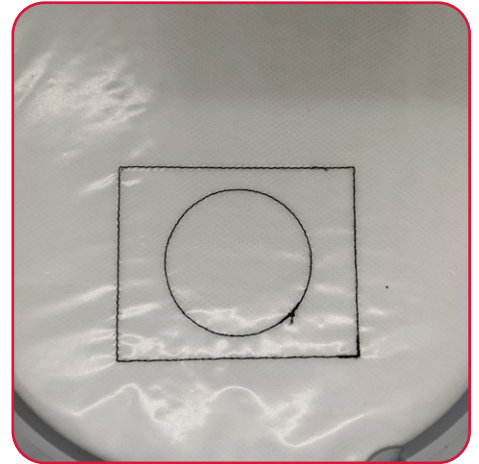

STEP 4

- Place the fabric right side up, over the placement stitch, covering entirely. Tape in place.

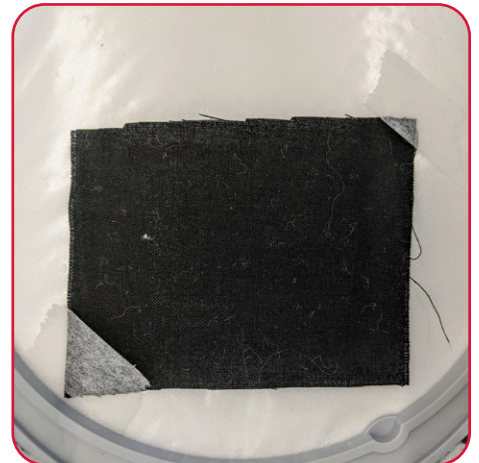

STEP 5

- Stitch Color 2, the Tackdown and Cut line.

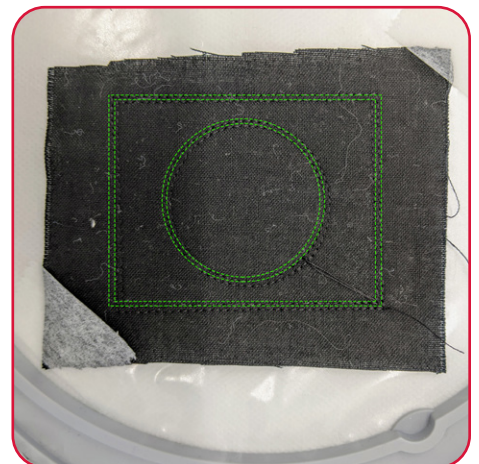

STEP 6

- Remove the hoop from the machine, but do NOT remove the project from the hoop. Trim the excess fabric as close to the tackdown as possible, without cutting the stitches.

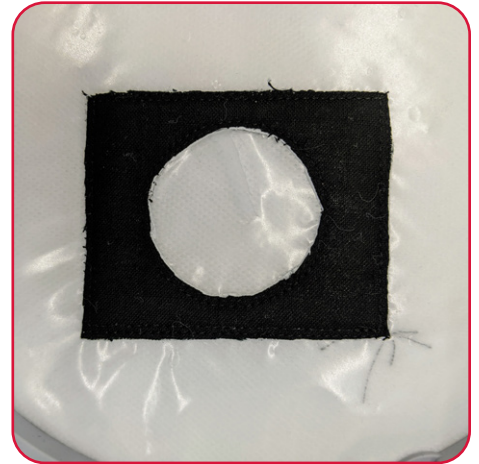

STEP 6 Continued

- Return the hoop to the machine and stitch remaining colors, following the thread chart.
- **Note:** Remember to change the bobbin to match the upper thread colors.

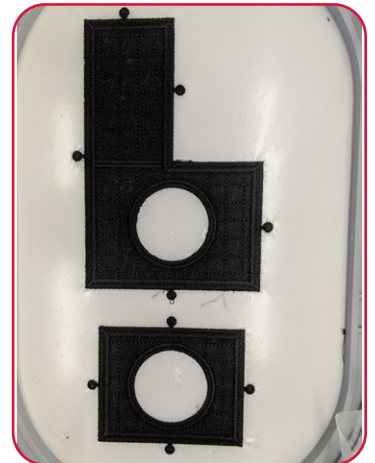

STEP 7

- When design is complete, remove the project from the hoop and trim the stabilizer about a ½" from the stitches.

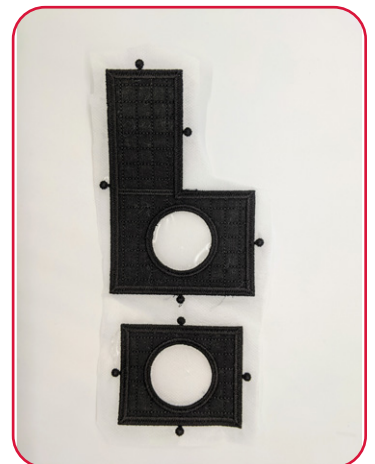

EMBROIDERY



STEP 8

- Rinse in warm running water until project is slightly sticky.



STEP 9

- Lay face down and let dry.
- Note: Do not place on a paper towel or towel with loops as they tend to stick to the design. Parchment paper or a cooling rack works well.



STEP 10

- Press face down on a Perfect Embroidery Pressing Cloth, if needed.



NOTE

- There is some sewing with this project. An open toe foot is helpful when sewing together. Use a zigzag stitch or serpentine stitch to sew together. Suggested settings: length- 1.5 and width- 4.0.

STEP 1 SECTION 1

- Sew together designs 12830-01, 12830-02, 12830-03 and 12830-04 as shown.

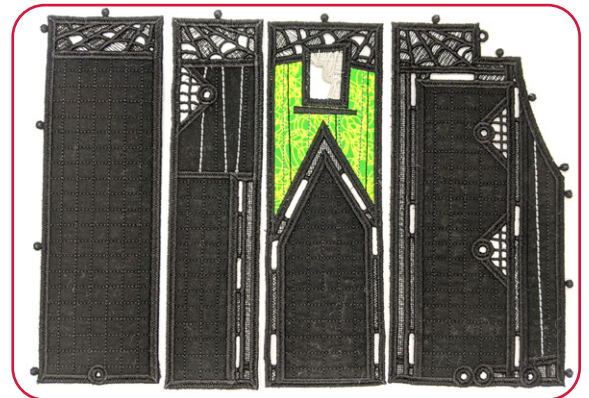

STEP 2

- Place 12830-01 and 12830-02 right sides facing up, lining up as shown.



ASSEMBLY



STEP 3

- Using a zigzag stitch, sew the two pieces together, backstitching at the beginning and end. Continue sewing the two remaining pieces to the first two.

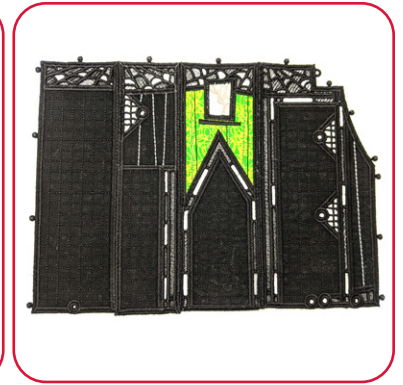
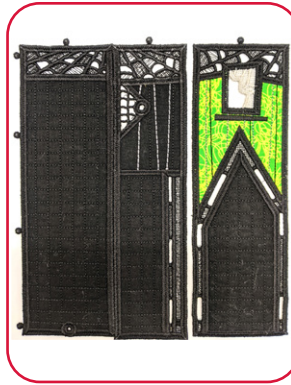
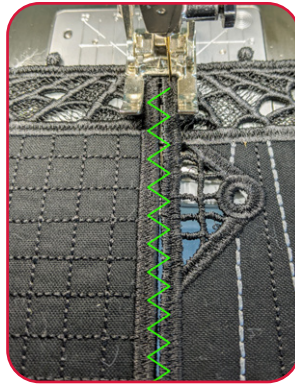

STEP 4 SECTION 2

- Using two of the lace boards from 12830-14, sew one to each of the windows in designs 05 and 07.



STEP 5

- Sew designs 12830-05, 12830-06 and 12830-07 together as shown in the photos.



STEP 6 SECTION 3

- Sew the remaining 2 lace boards from 12830-14 over the window in 12830-08.

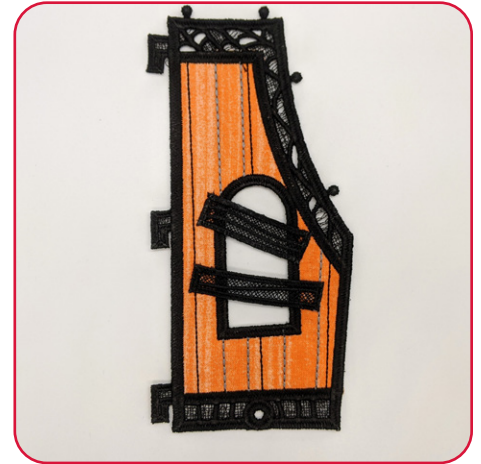

STEP 7

- Sew designs 12830-08, 12830-09 and 12830-10 together as shown in the photos.



STEP 8 SECTION 4

- Sew designs 12830-11, 12830-12 and 12830-13 together as shown.

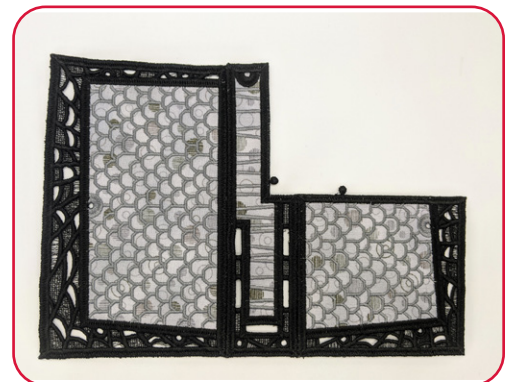
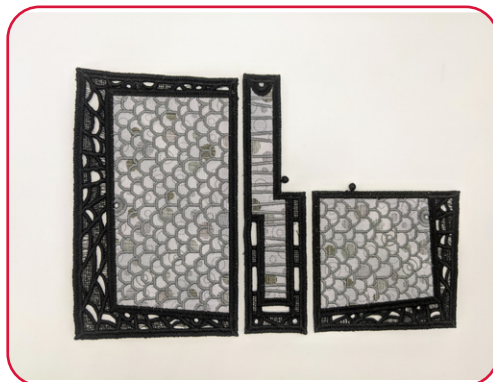

STEP 9 SECTION 5

- Designs 12830-15(front door) and 12830-16(roof)



STEP 10

- Bend the three sections of 12830-15 as shown.



STEP 11

- Insert the alligator clamps through the eyelet in the roof, grab the corresponding buttonette and pull through. Repeat for the other buttonette.

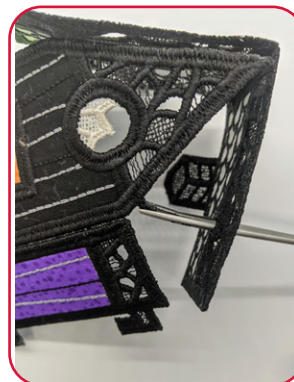

STEP 12

- Attach Section 5 to Section 1, inserting the tabs into the corresponding slots, as shown.

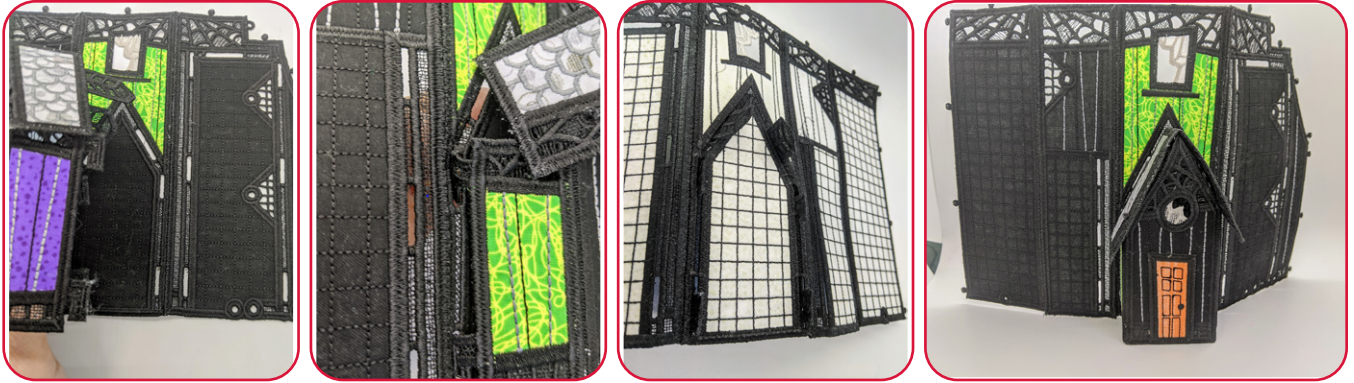

STEP 13

- Bend Section 5 so that the buttonettes line up with the eyelets. Pull the 4 buttonettes through the eyelets as shown. This forms a tower. Set aside.



STEP 14

- Section 2 and Section 4 (roof) will be connected next. Bend each section as shown.

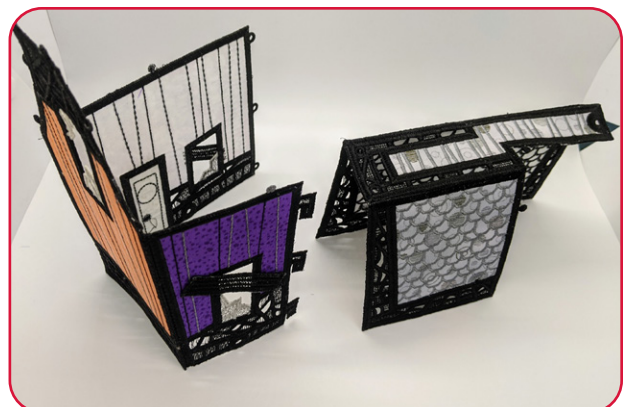

STEP 15

- Attach each buttonette on Section 2 to the eyelets in the roof.



STEP 16

- Section 3 and design 12830-13 (roof) .



STEP 17

- Bend the 3 pieces of section 3.



STEP 18

- Bend the roof. Match the eyelets and buttonettes. Pull each buttonette through the corresponding eyelet, using button clips to temporarily hold them in place, as needed.

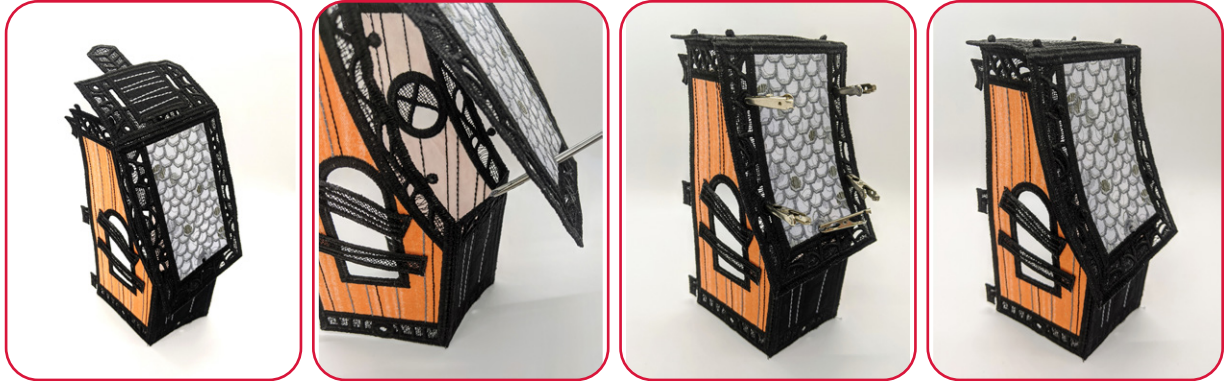

STEP 19

- Attach Section 2 to the left side of Section 1, inserting the tabs into the slots and buttonettes into the eyelets, as shown.

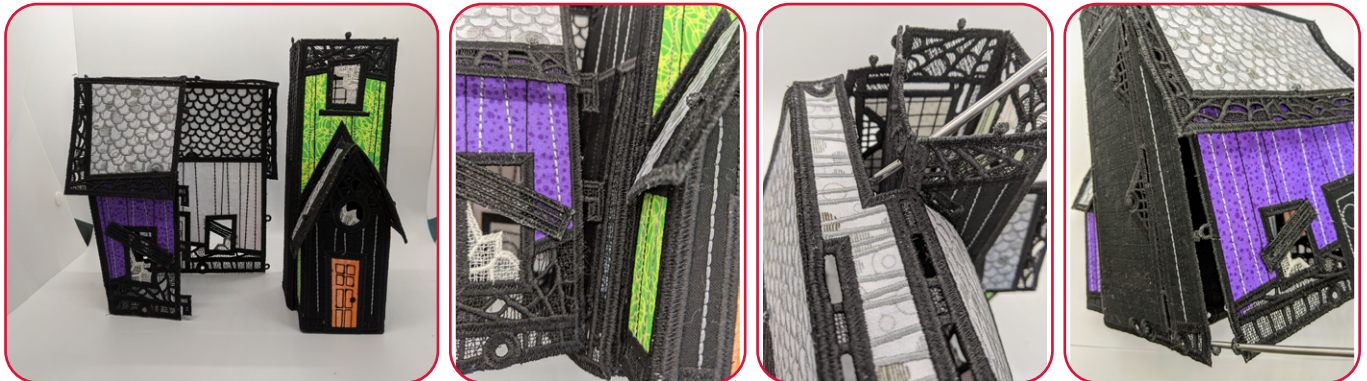

STEP 20

- Attach Section 3 to the right side of Section 1, inserting the tabs into the slots.
- **Note:** After putting the tabs of one side into the slots, twist them slightly to help them stay in place, or use Button clips to temporarily hold them.



STEP 21

- Attach the two pieces of 12830-23 to the bottom of the mansion, inserting the buttonettes into the corresponding eyelets

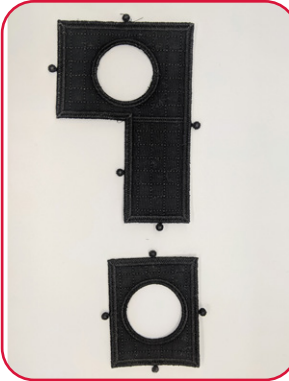

STEP 22

- Attach design 12830-18 to the top of the tower pulling the 4 buttonettes through the eyelets.



STEP 23

- Cupola and Roof.

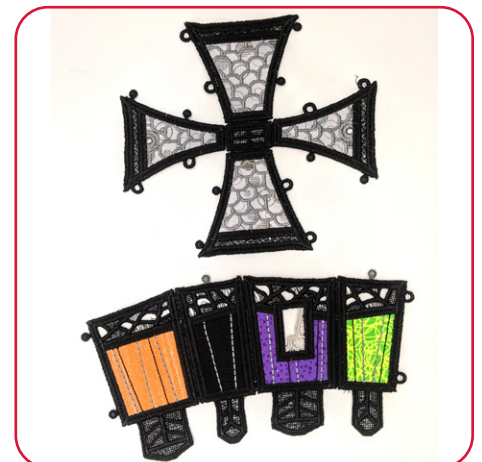

STEP 24

- Bend design 12830-19 and pull the 2 buttonettes through the corresponding eyelets.

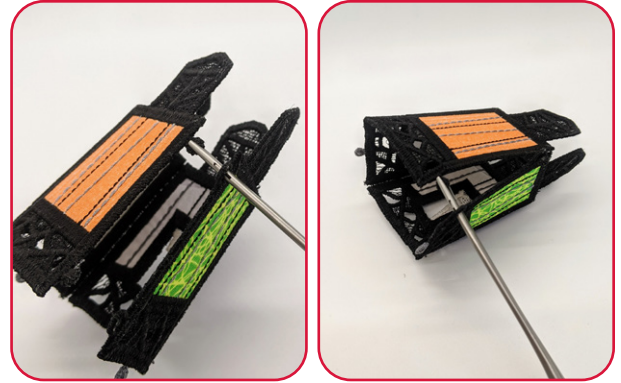

STEP 25

- Starting at the top of the roof (design 12830-20), pull buttonettes through each eyelet.

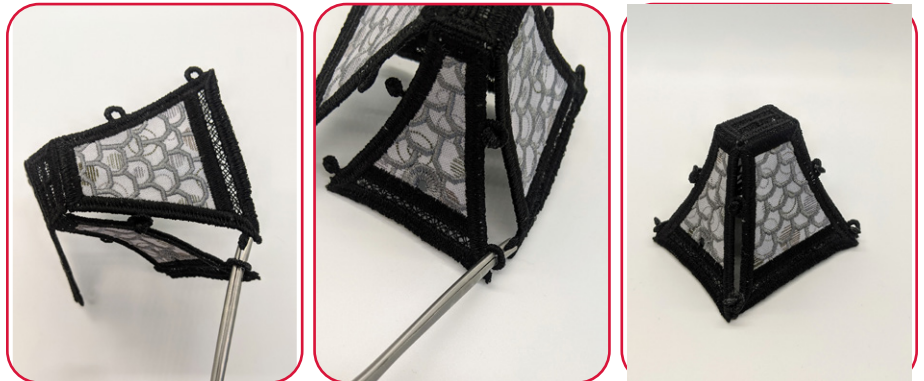

STEP 26

- Attach the roof to the cupola by pulling the buttonettes through the eyelets in the roof.

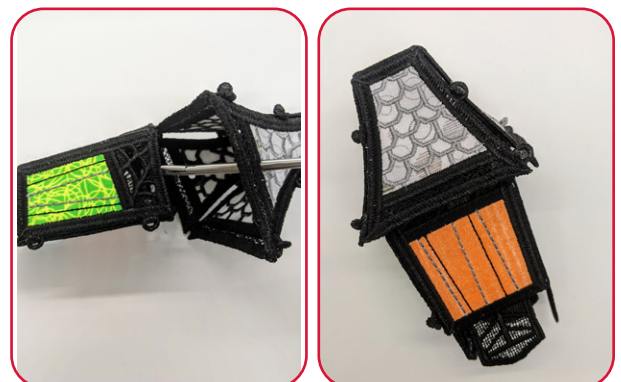

STEP 27

- Attach the completed cupola to the center of the roof by inserting the tabs into design 12830-18.



STEP 28

- Design 12830-22 is the Iron Cresting that attaches to the top of the roof.



STEP 29

- Bend the larger one and attach to the left side of the mansion by inserting the tabs into the roof.

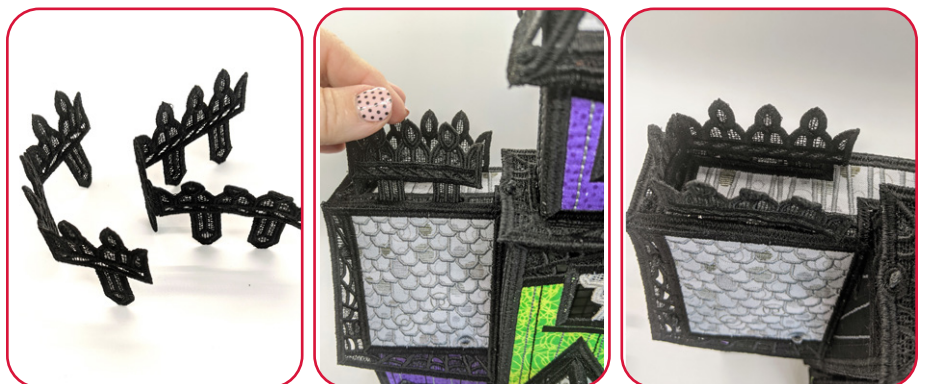

ASSEMBLY



STEP 30

- Bend the smaller one and insert the tabs into the slots in the right side roof.

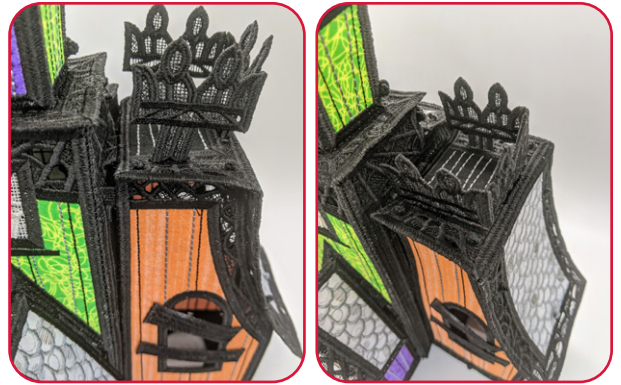

STEP 31

- The haunted mansion is now complete!



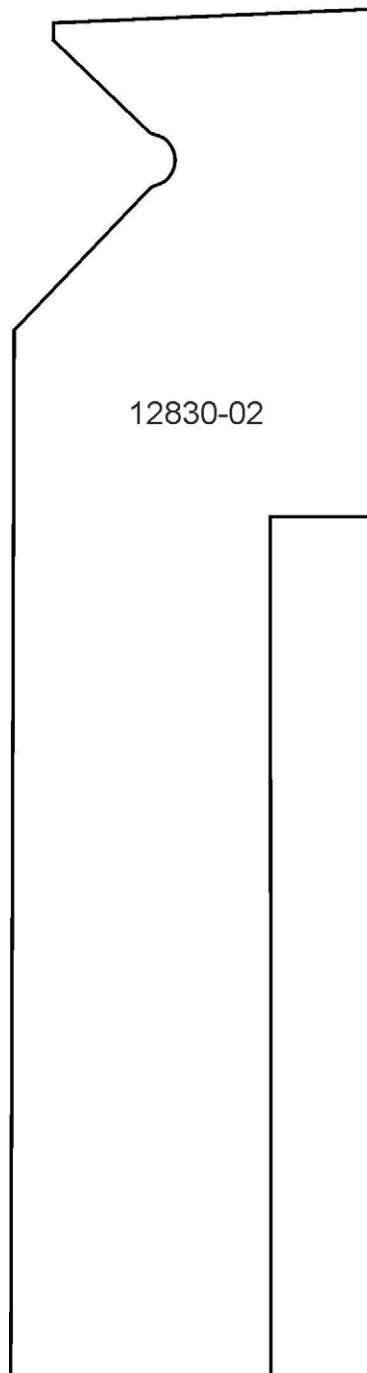
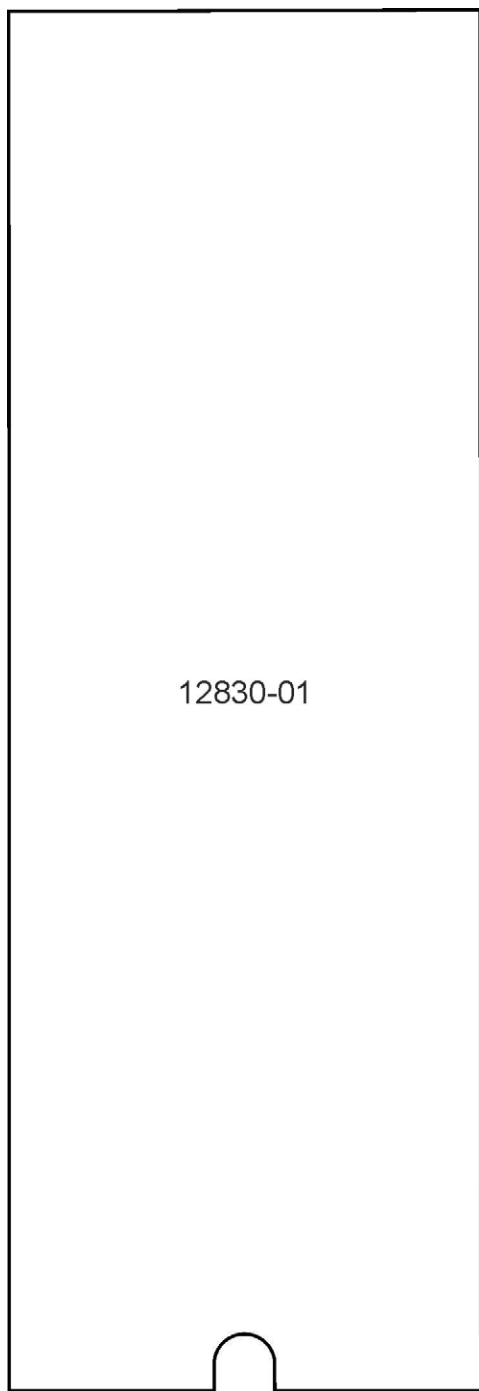

APPLIQUE PATTERNS

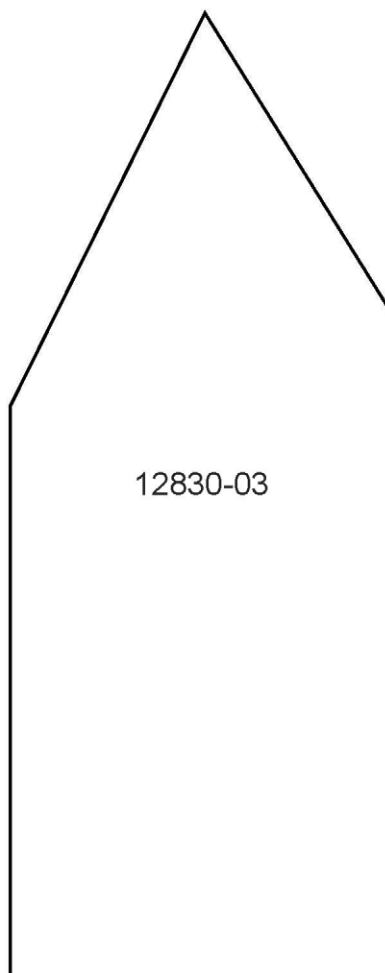
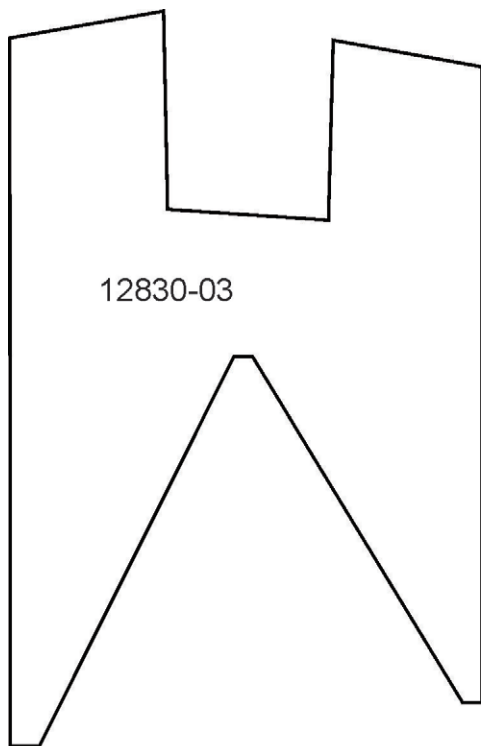

APPLIQUE PATTERNS

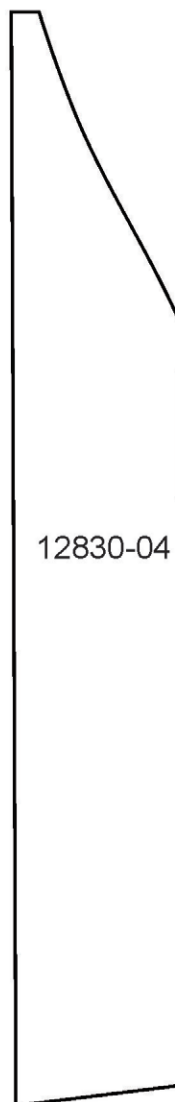
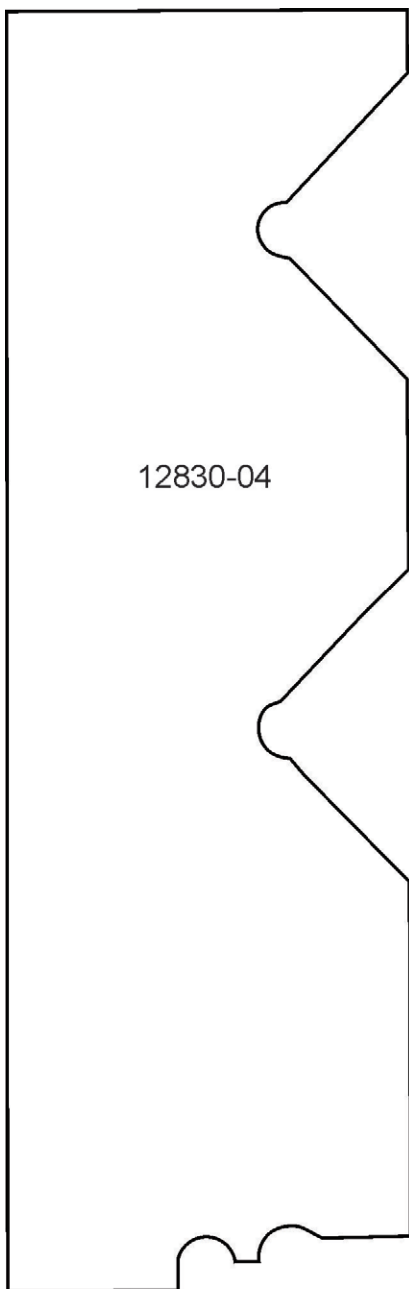

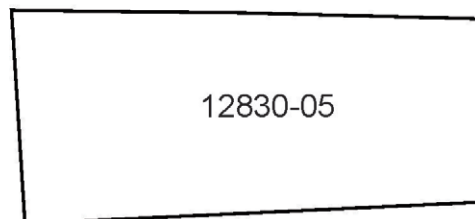
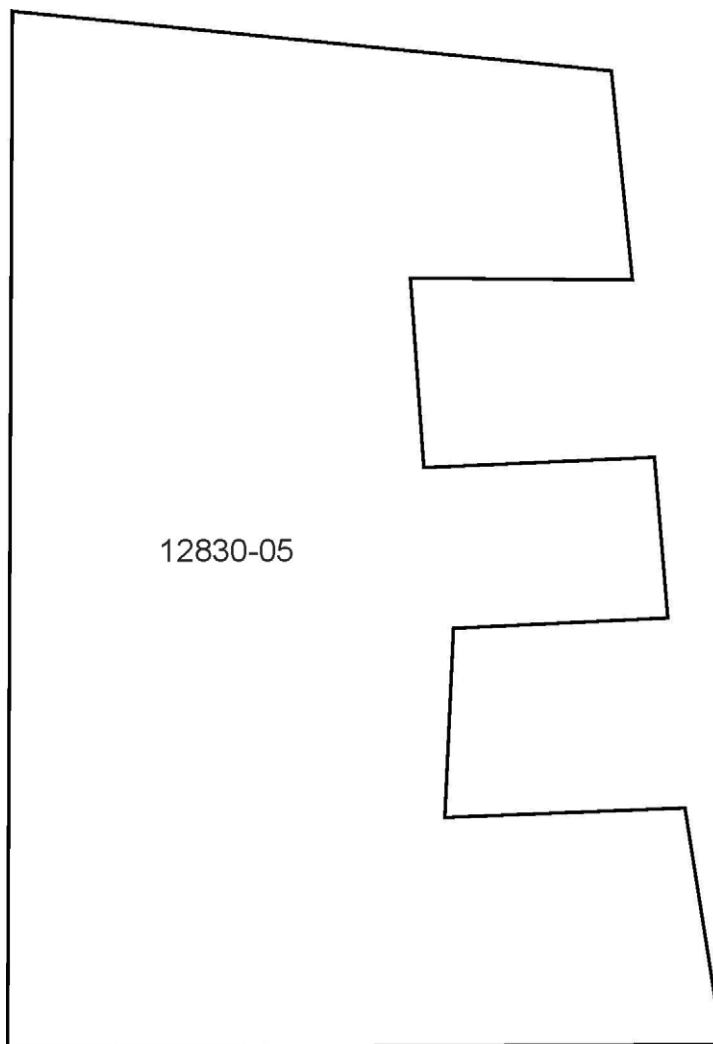

APPLIQUE PATTERNS

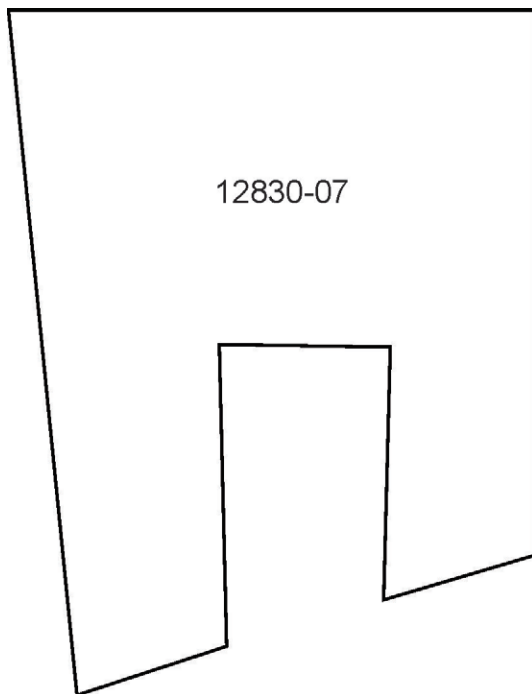
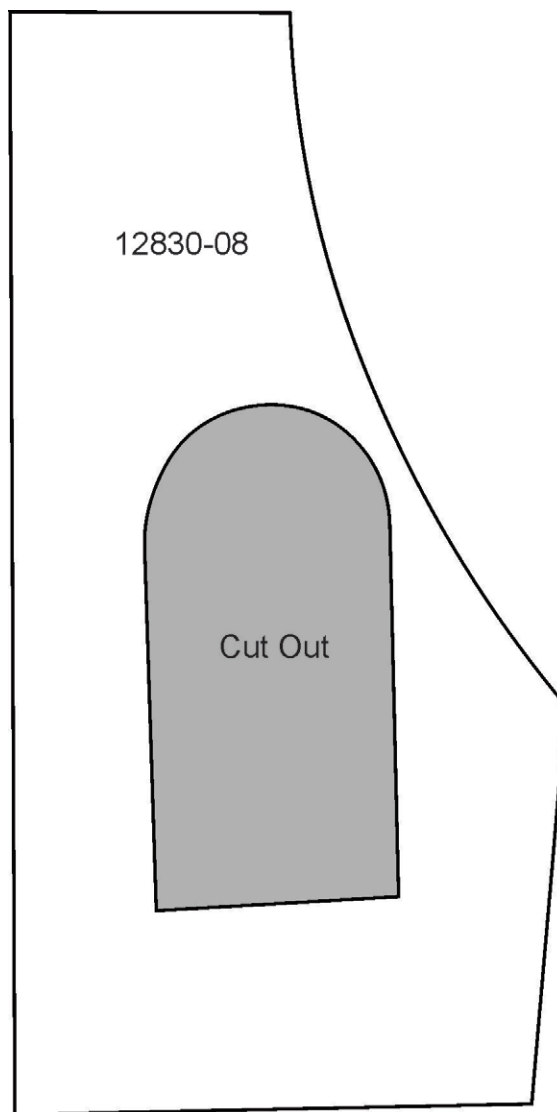
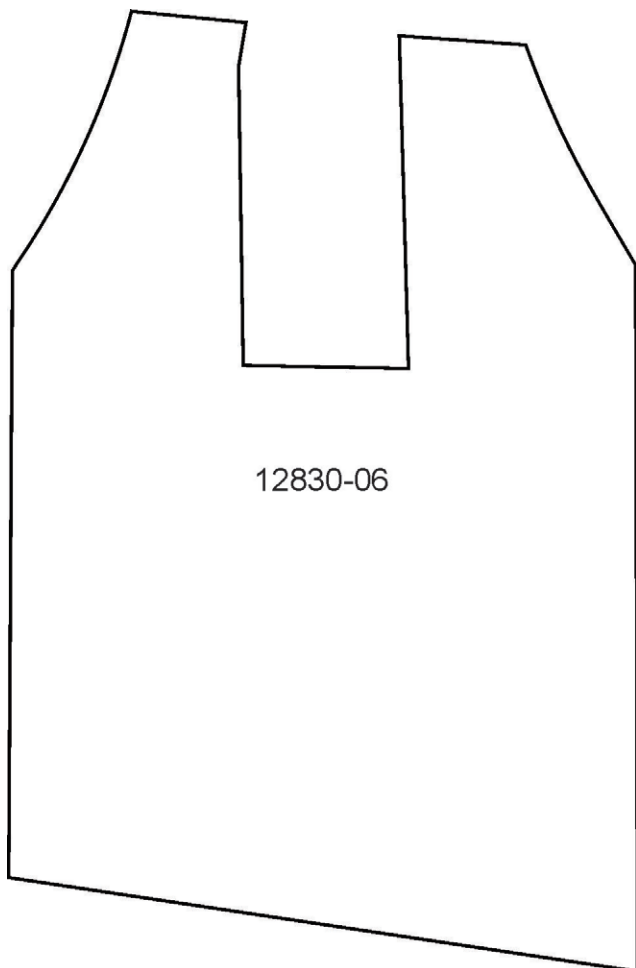

APPLIQUE PATTERNS

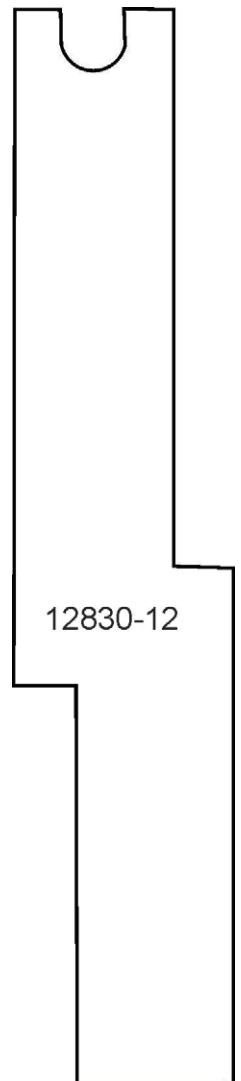
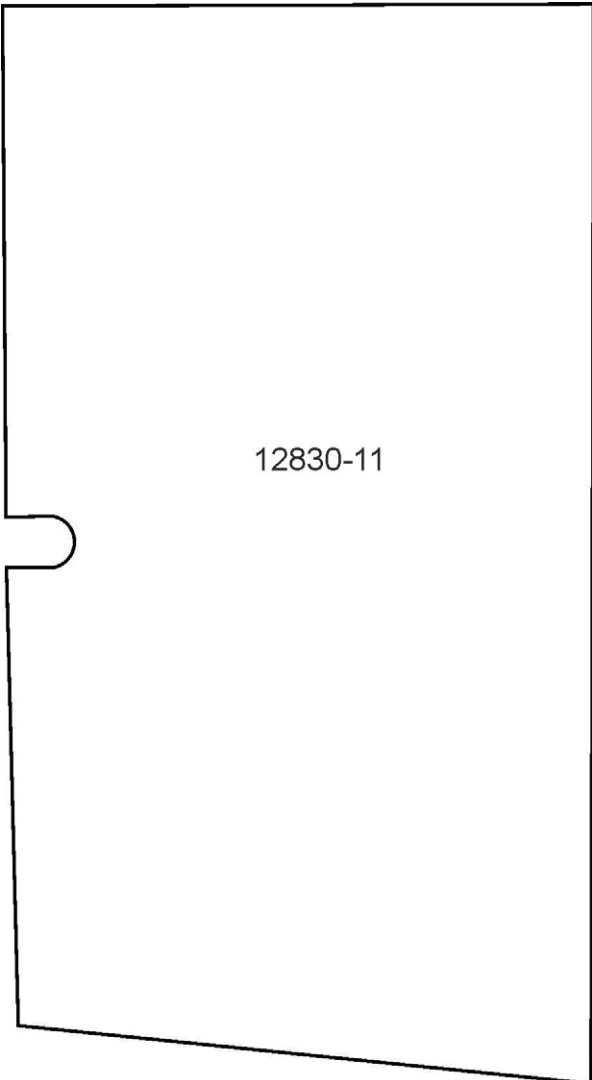
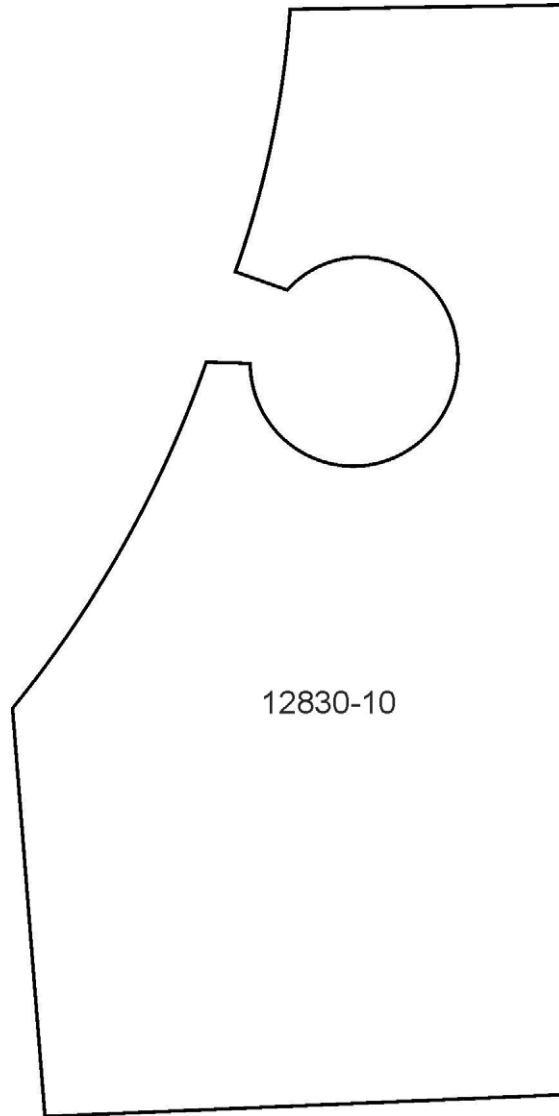
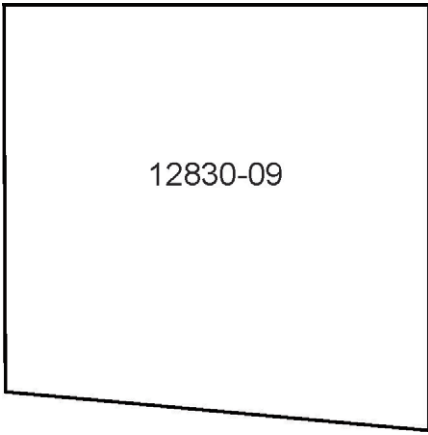

APPLIQUE PATTERNS

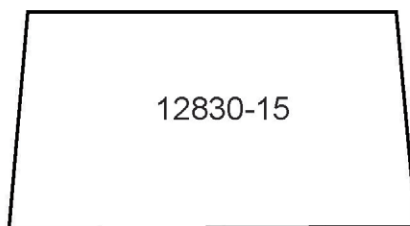
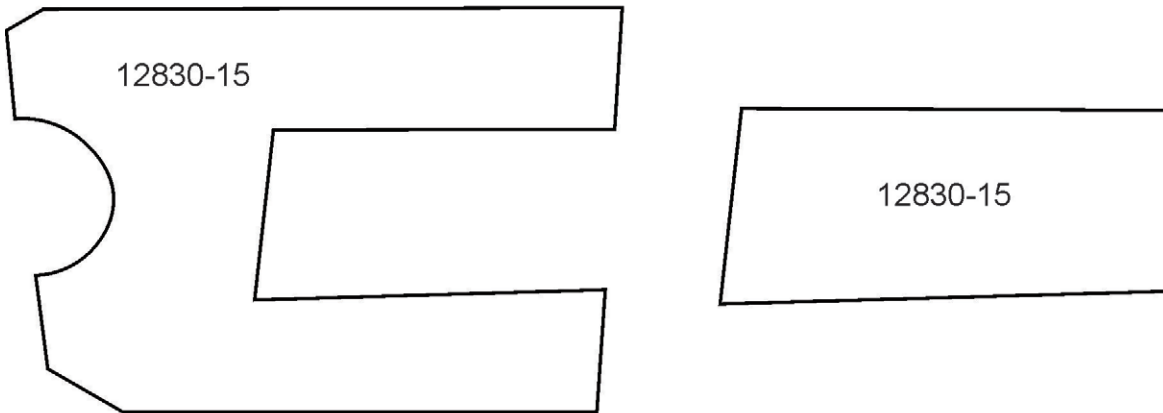
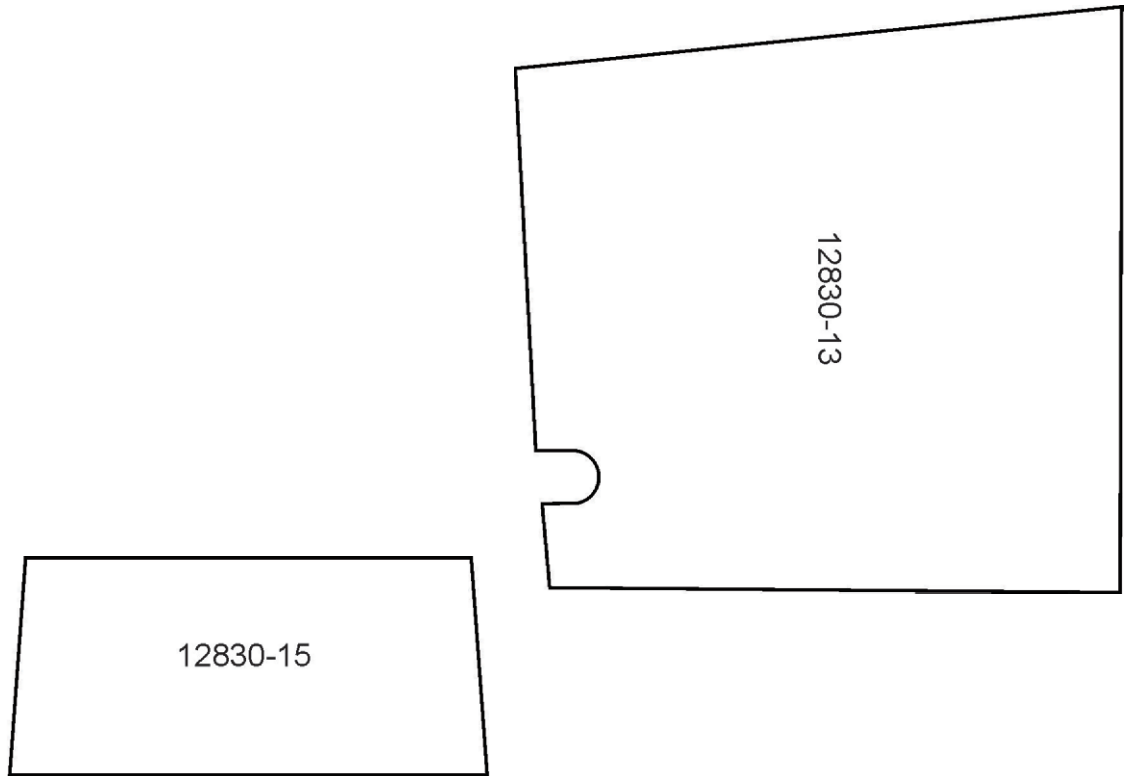

APPLIQUE PATTERNS

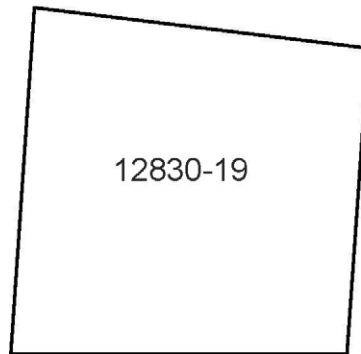
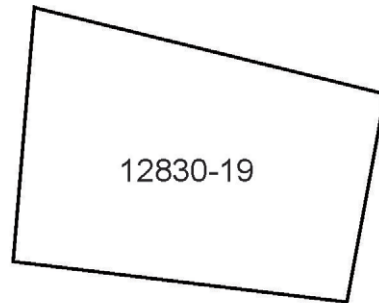
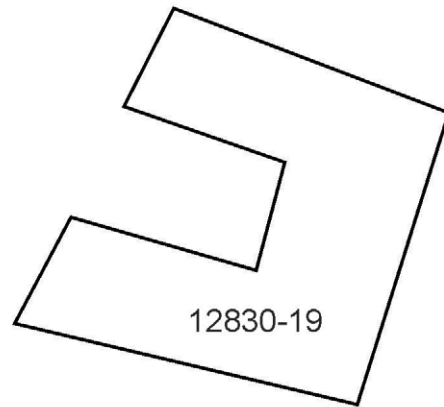
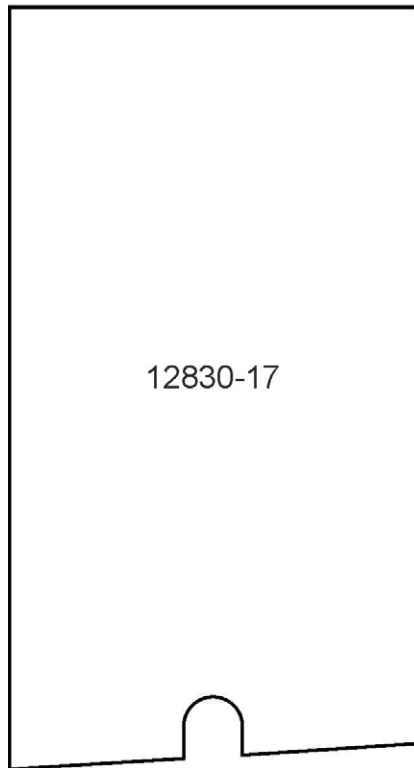
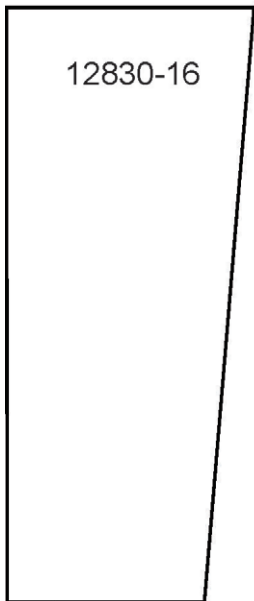
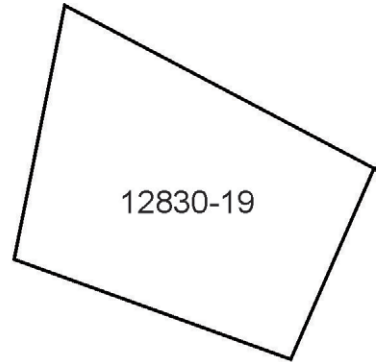
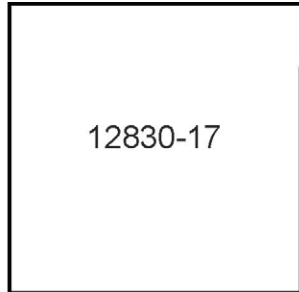
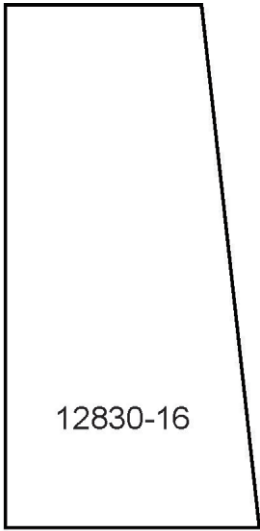

APPLIQUE PATTERNS

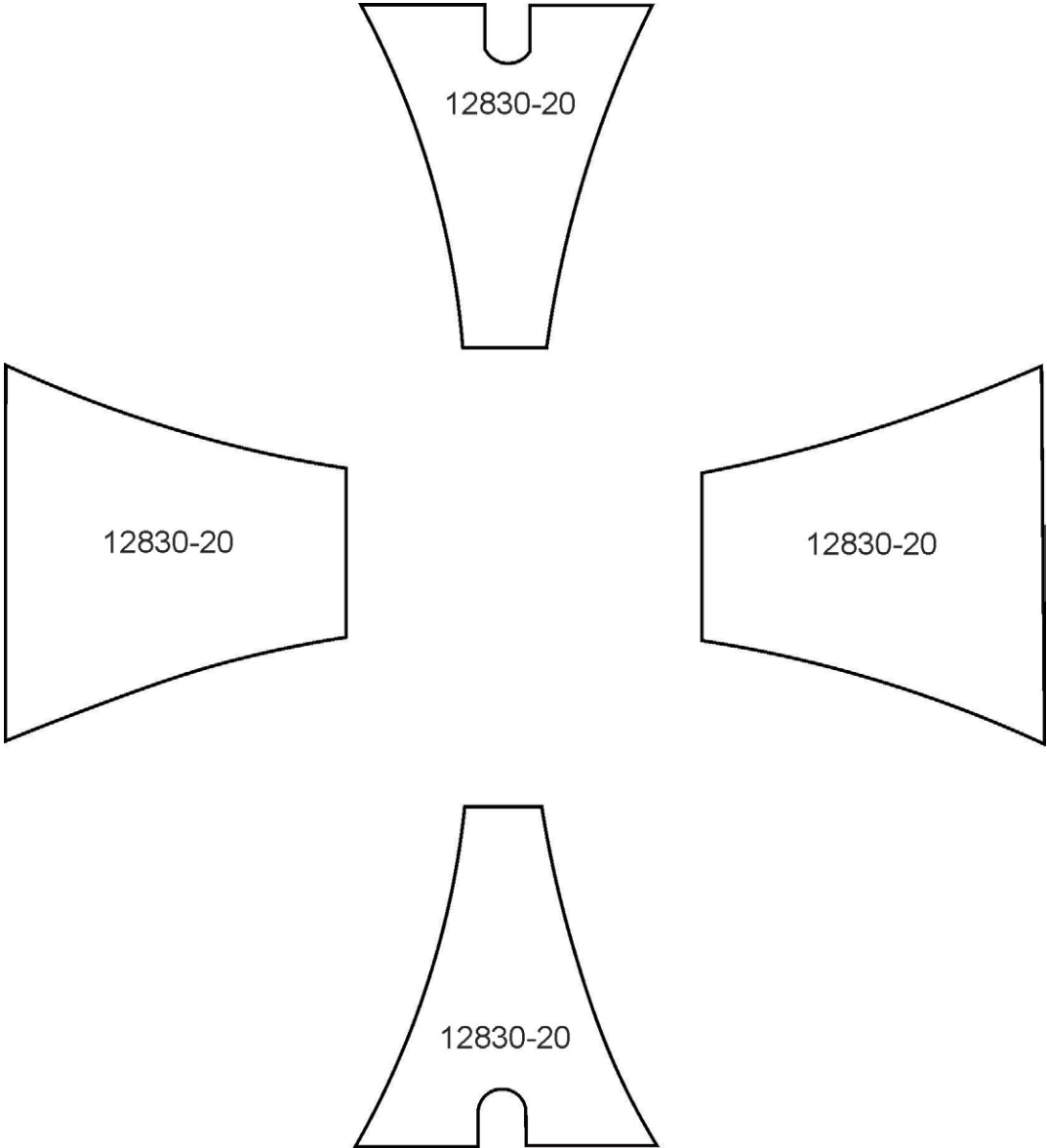

APPLIQUE PATTERNS

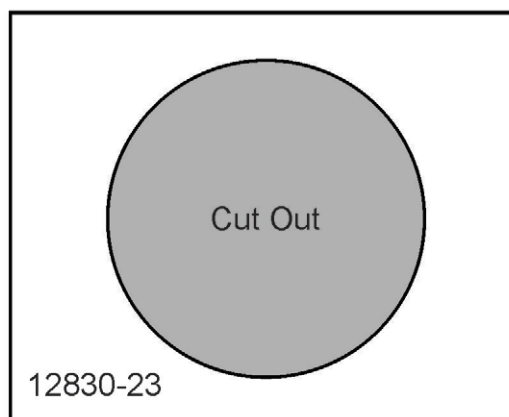
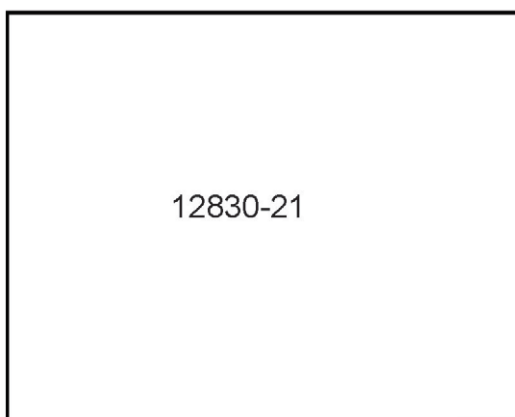
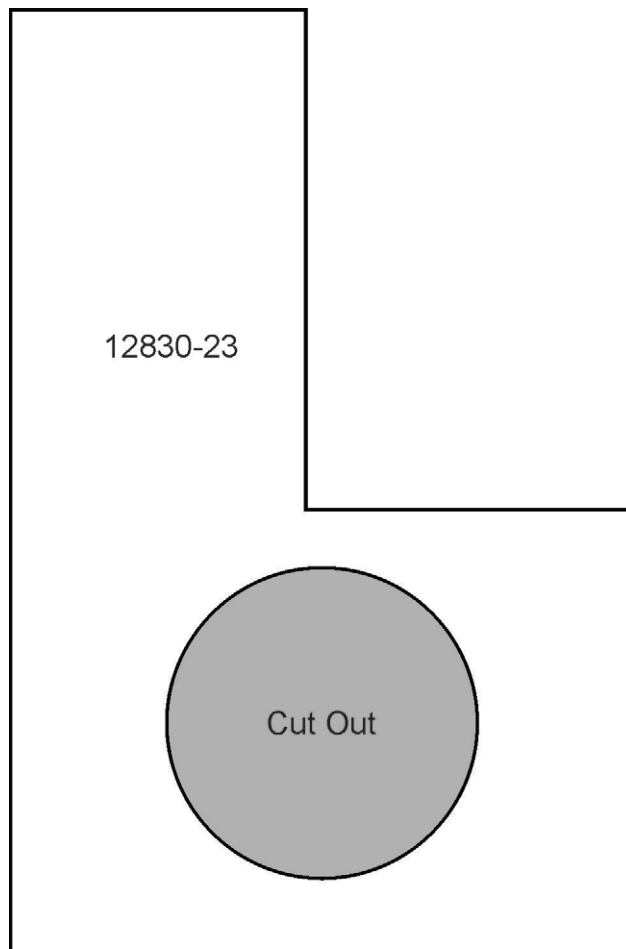
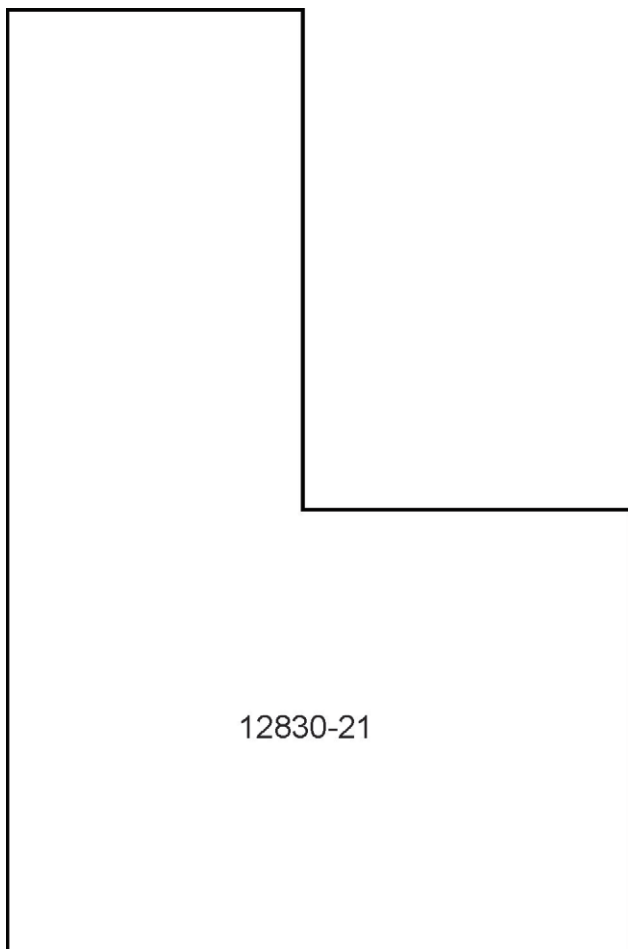

MIRRORED PATTERNS

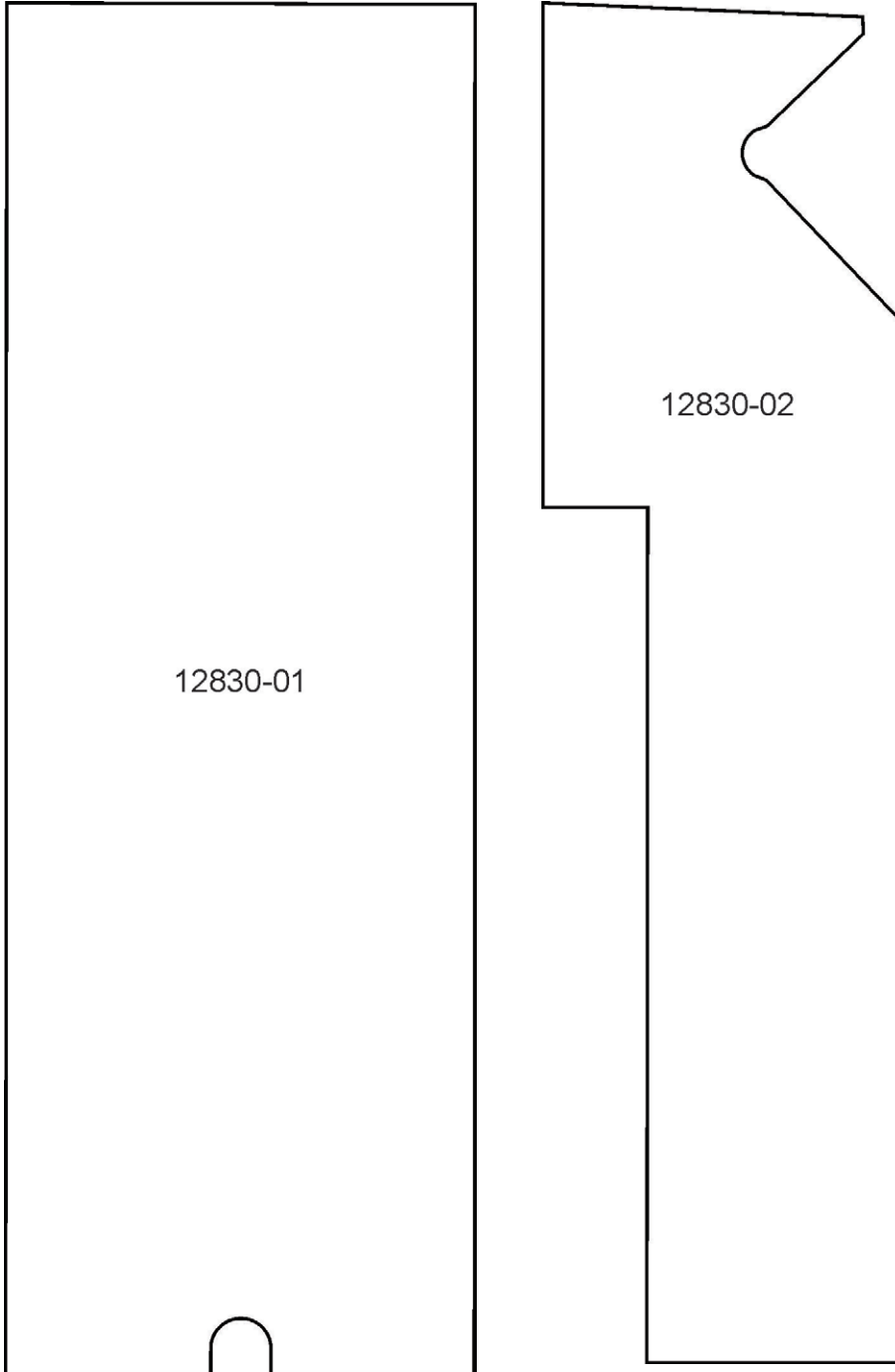

MIRRORED PATTERNS

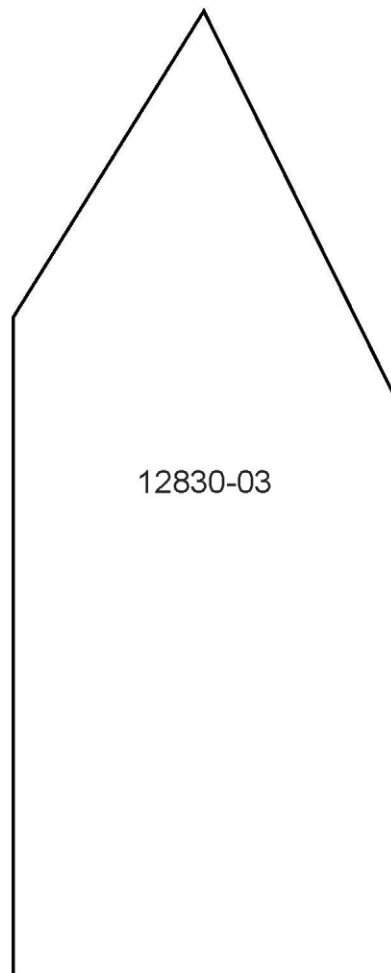
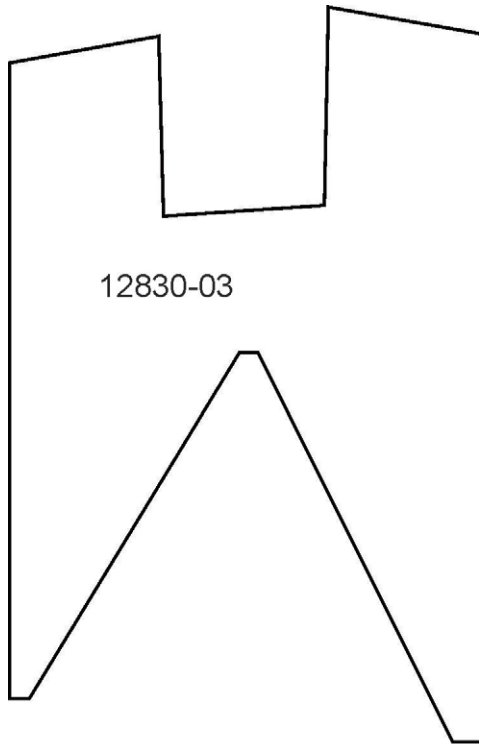

MIRRORED PATTERNS

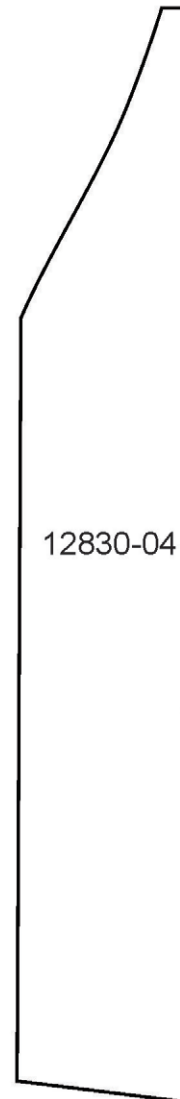
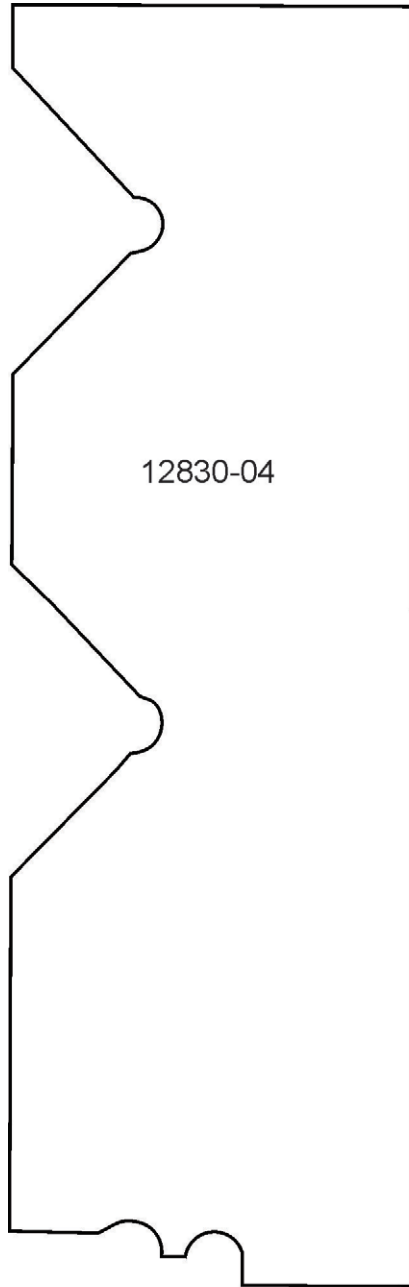

MIRRORED PATTERNS

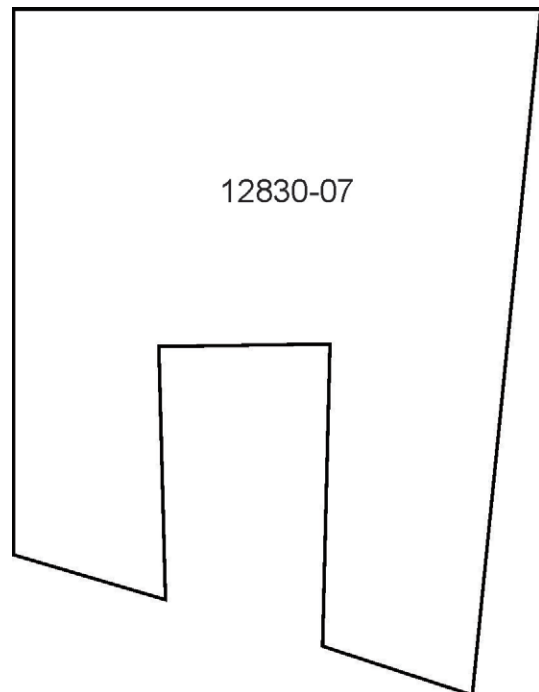
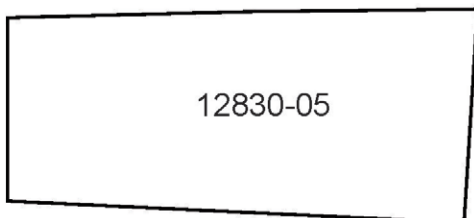
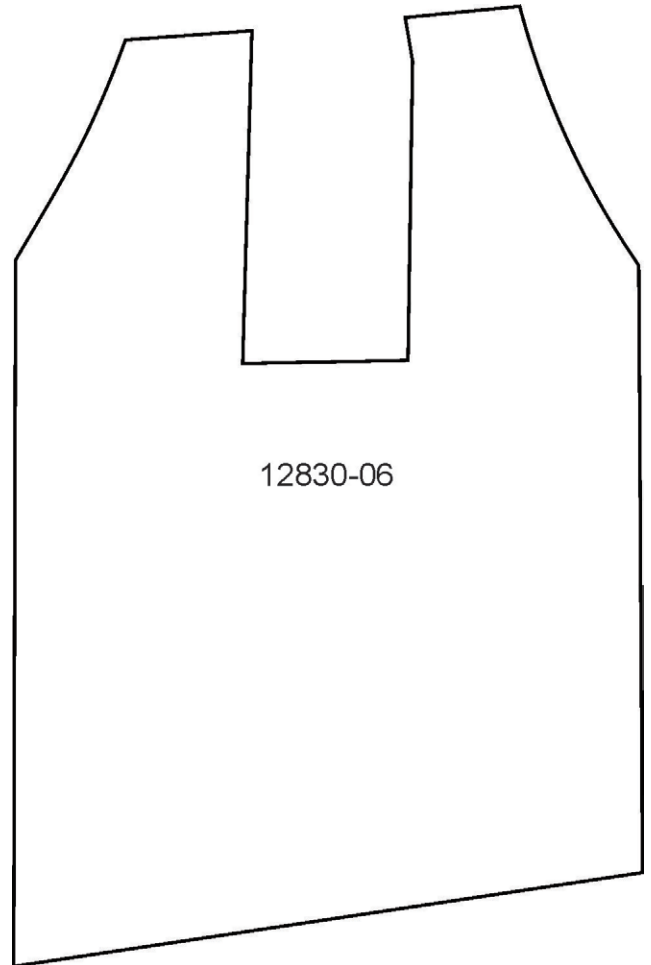
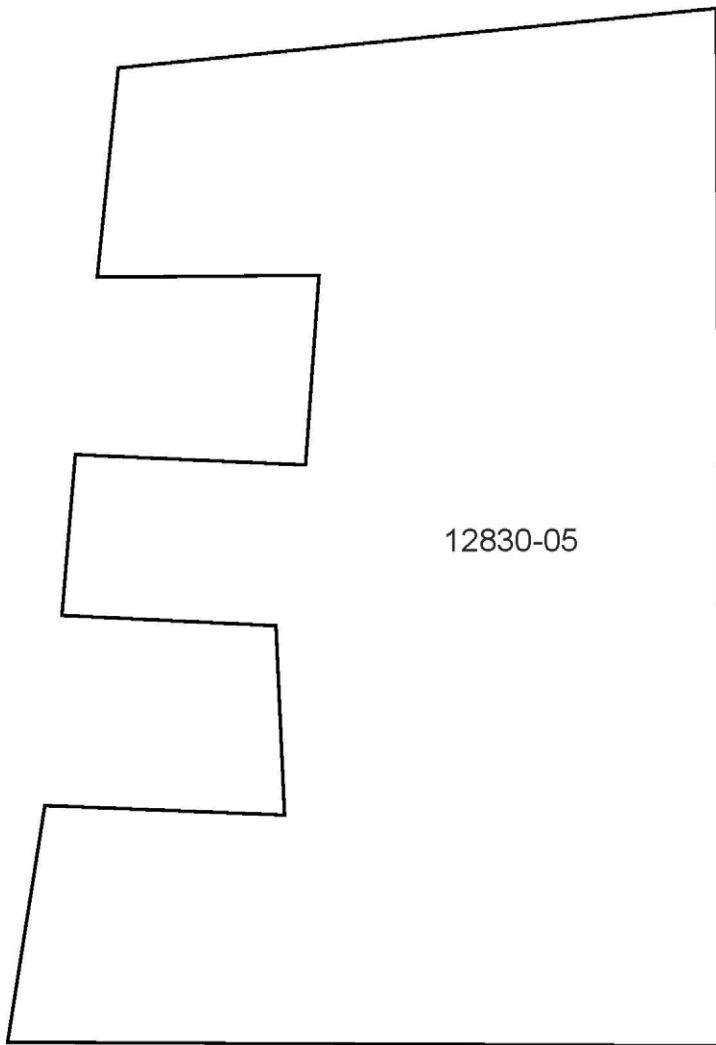

MIRRORED PATTERNS

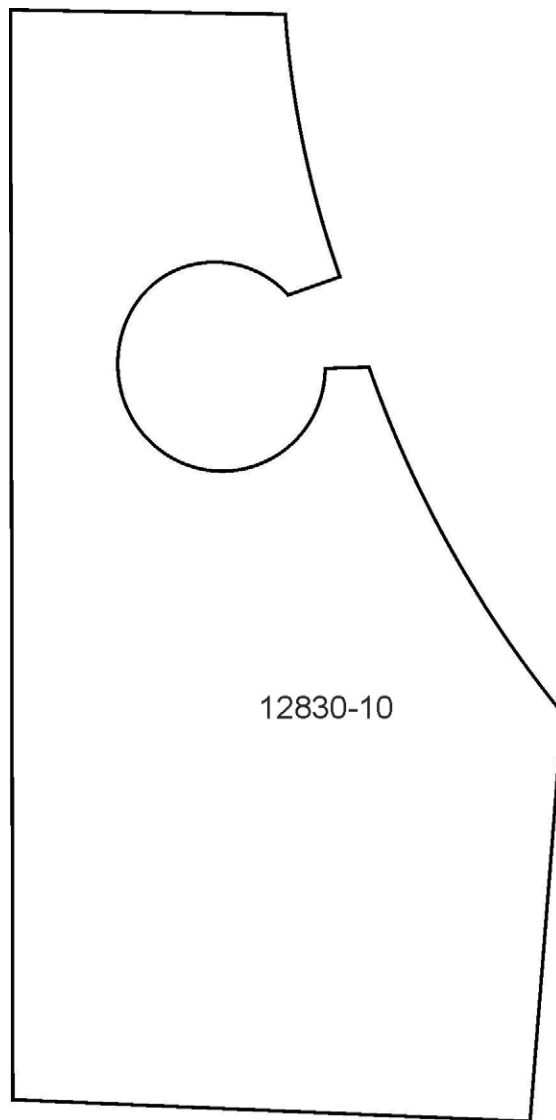
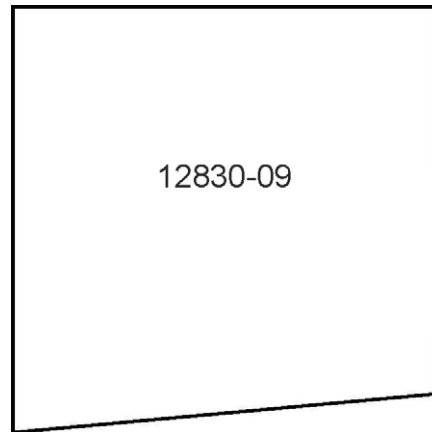
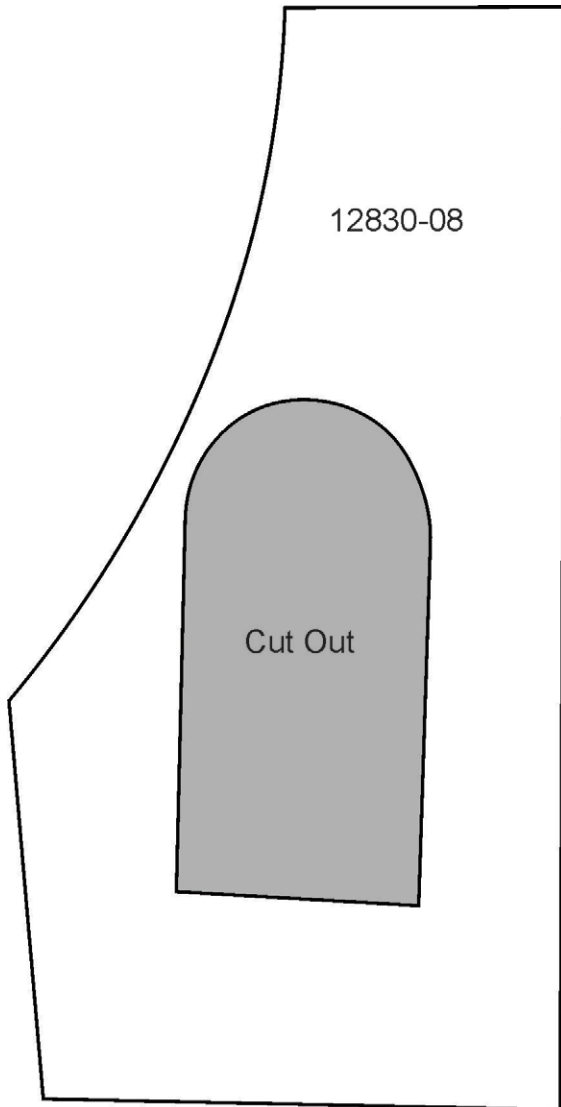

MIRRORED PATTERNS

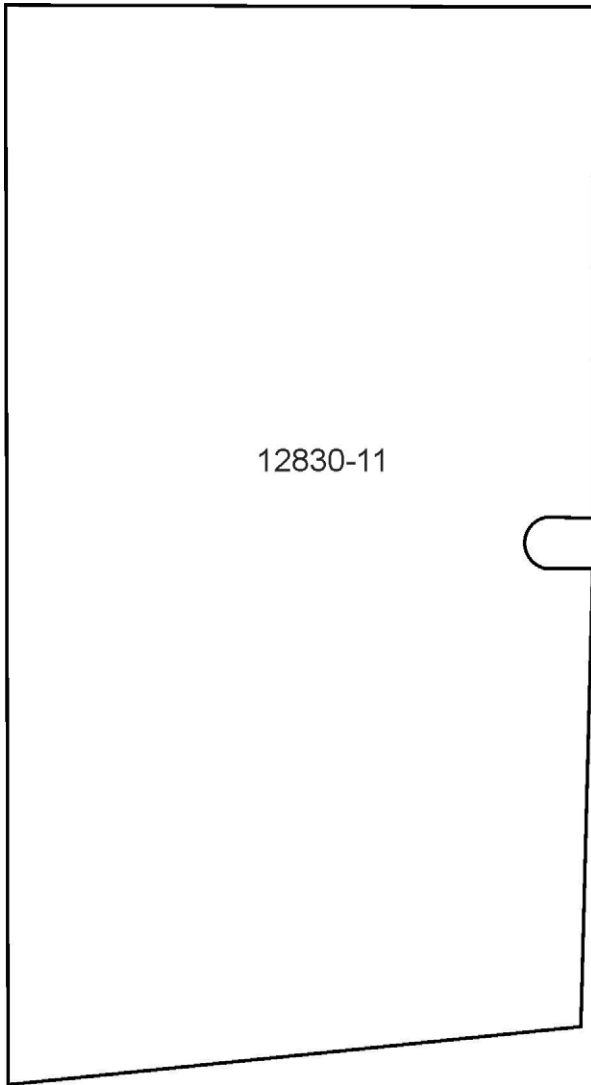

12830-11

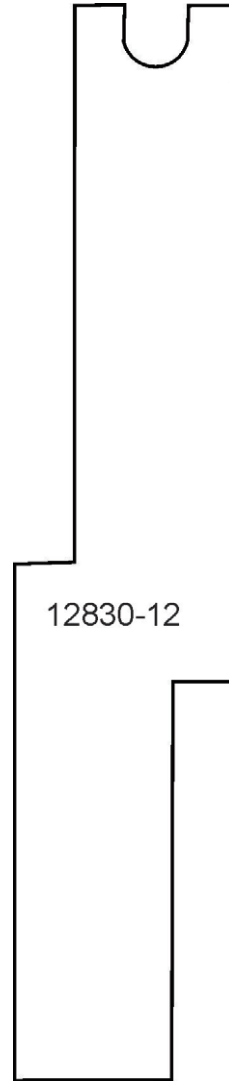

12830-12

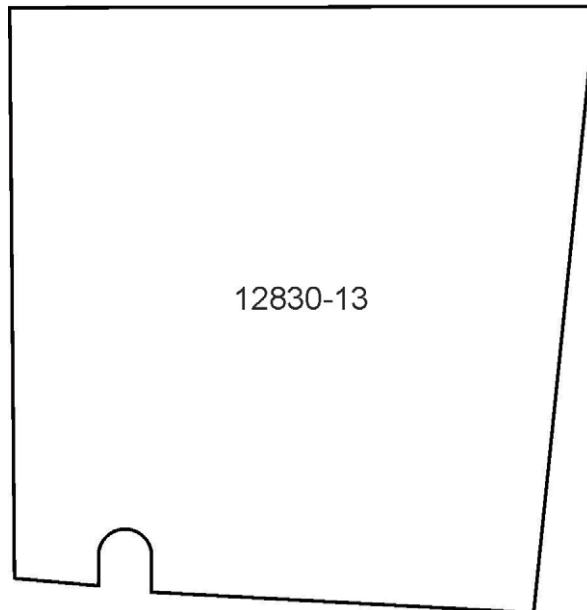

12830-13

MIRRORED PATTERNS

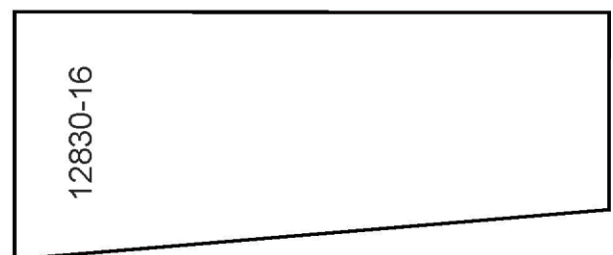
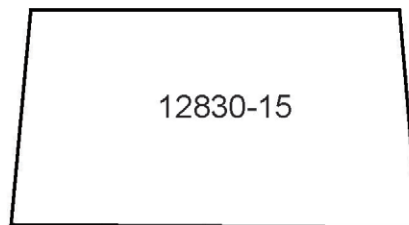
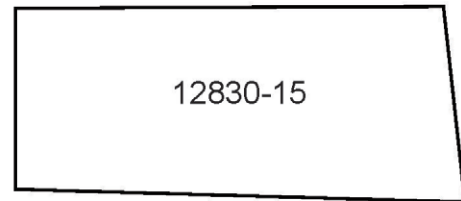
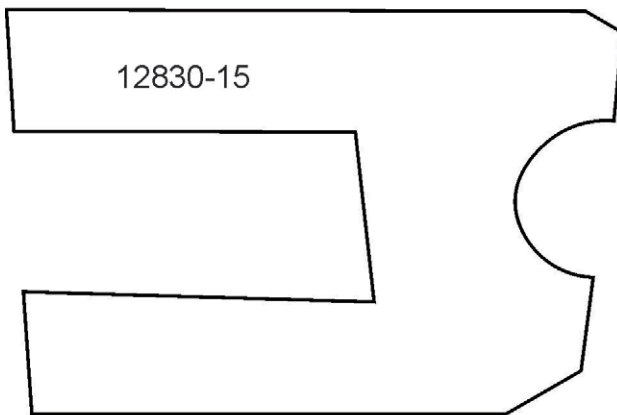

MIRRORED PATTERNS

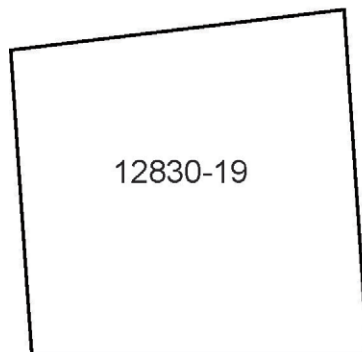
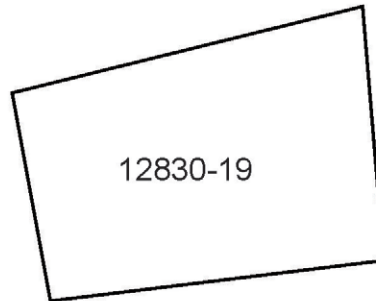
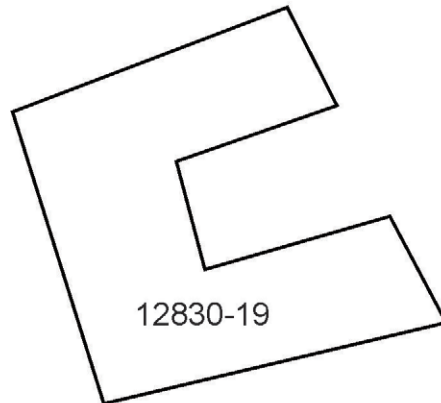
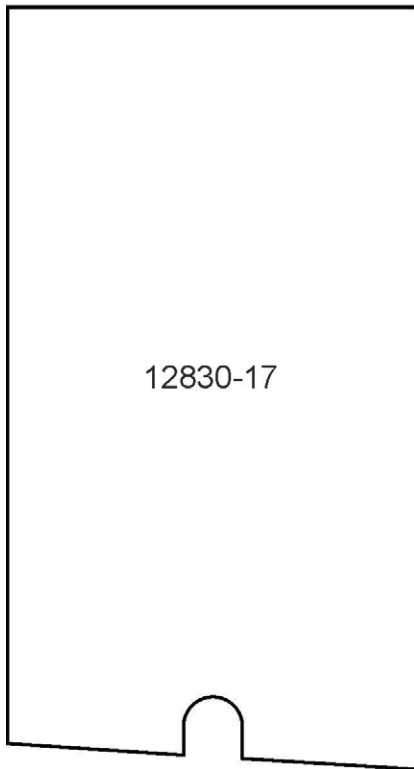
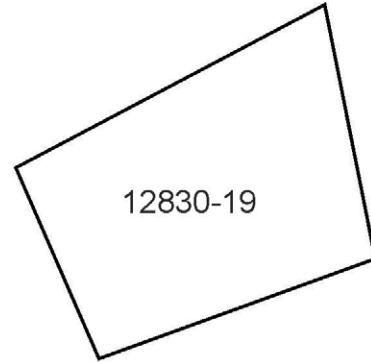
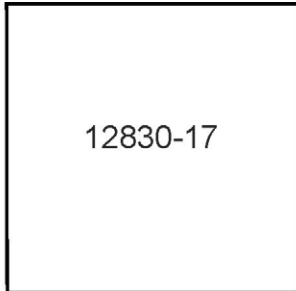

MIRRORED PATTERNS

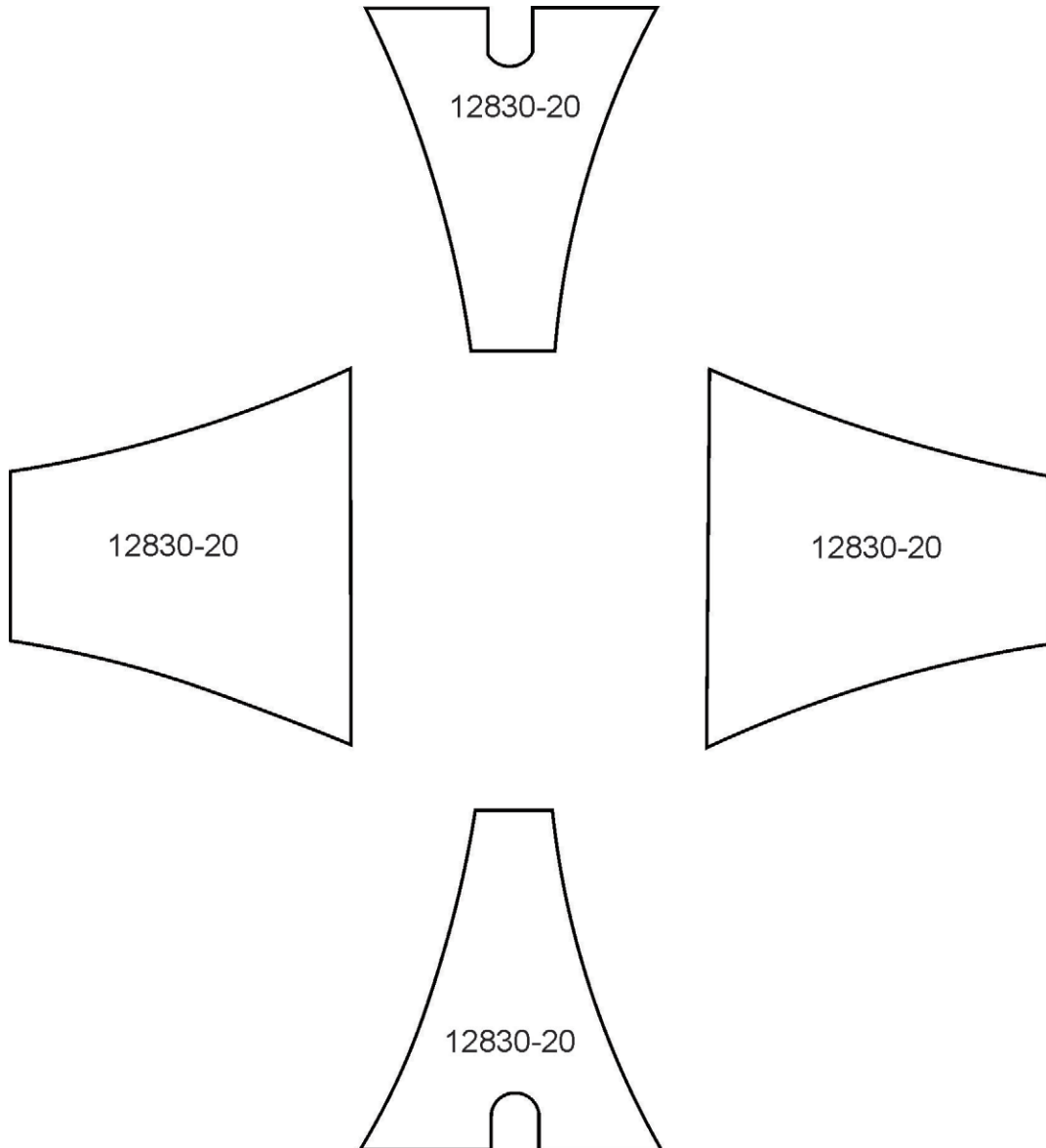

MIRRORED PATTERNS

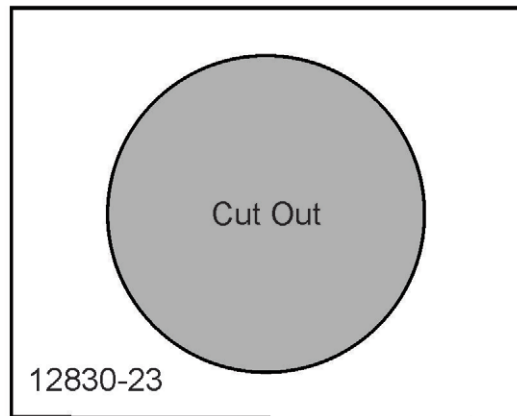
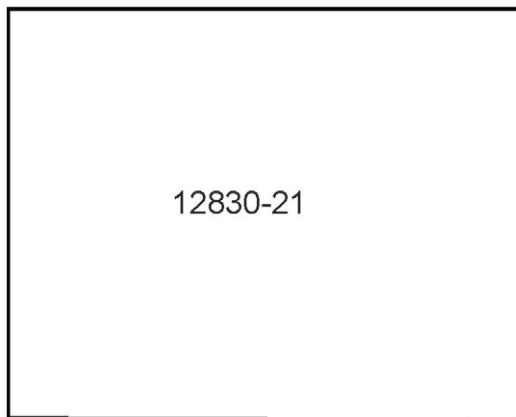
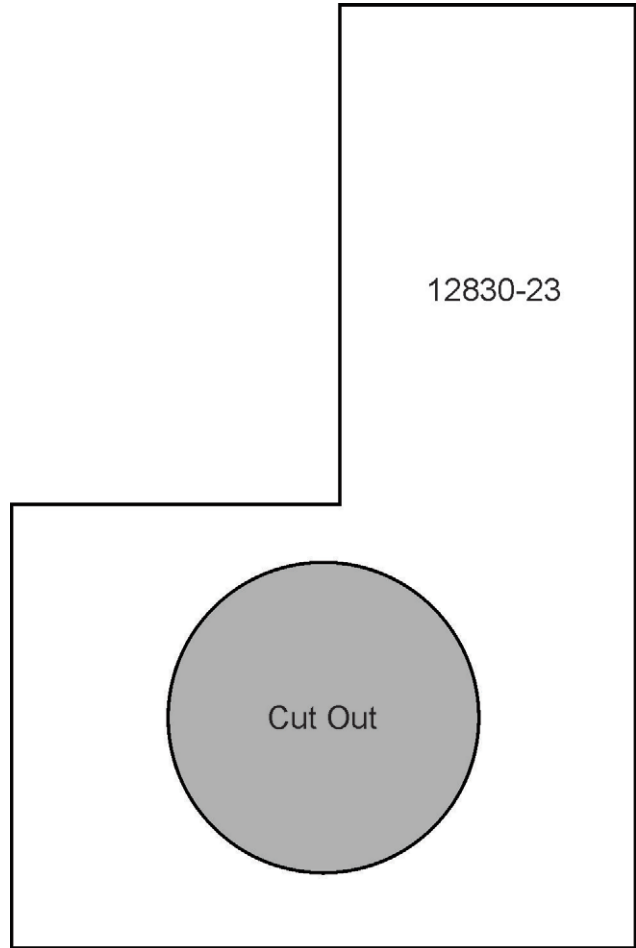
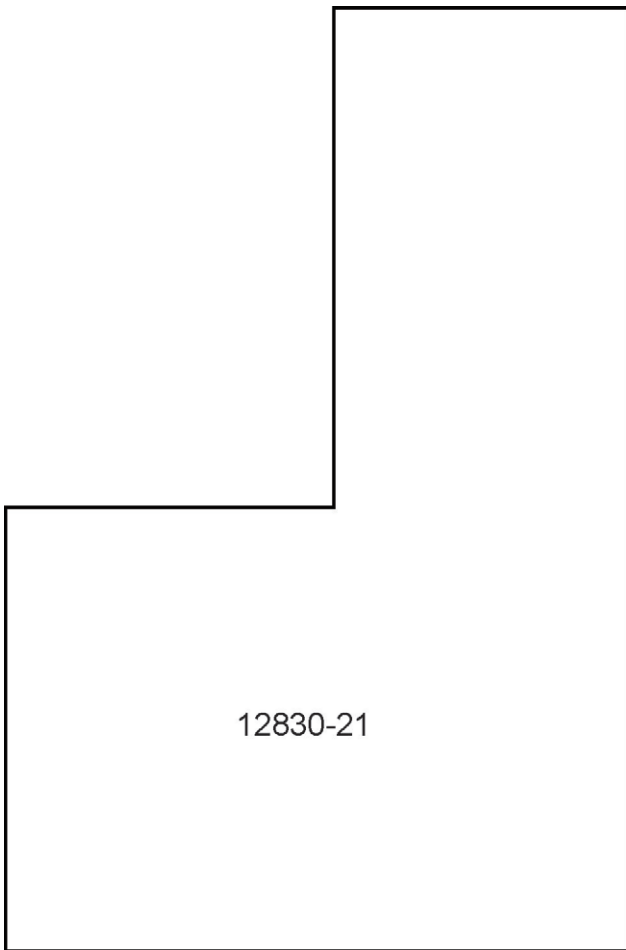

General Freestanding Lace Guidelines

Supplies:

Embroidery Thread:

- Use the same embroidery thread in the bobbin as the needle.

Needles:

- Use an Organ 80/12 Titanium needle for extended needle life.

Stabilizer:

- Use OESD AquaMesh stabilizer.

Handy Hints:

For Stiffer Lace:

- DO NOT rinse away all of the stabilizer for a “stiffer” lace. Note that the thread may appear a shade darker if stabilizer is not removed completely.
- If you happen to wash too much out, easily re-stiffen by diluting some stabilizer scraps in water and dipping the item in the solution.

For Very Soft Lace:

- Cut away excess stabilizer. Remove remaining stabilizer by rinsing under warm running water until all traces of the stabilizer are gone. **NOTE:** If lace should become too limp to work with, dissolve stabilizer scraps in warm water and apply to the lace.

Drying Lace:

- The lace looks best when left to dry completely. Lay lace piece with right side down to dry. This will minimize the tendency for the lace to curl. Be sure to flatten the piece out entirely and allow ample time to dry.

General Instructions

1. Hoop two layers of OESD AquaMesh Stabilizer.
2. Attach the hoop to the machine and select the design of your choice.
3. Stitch the design.
4. Remove the hoop from the machine and the design from the hoop. Trim excess stabilizer from the design.
5. Rinse away remaining stabilizer and allow it to dry.

Handy Hints:

For 3D Lace Projects:

- If item becomes too limp to work with, iron the lace pieces on the wrong side while applying spray starch. After ironing, spray again with starch and allow to dry completely. This will stiffen the lace pieces nicely and aid in construction.
- A pair of tweezers, hemostats, stiletto or a tiny crochet hook can be extremely helpful when inserting the buttonettes into the eyelets. (Please see **Diagram 1** for explanation of “buttonette” and “eyelet”.)
- Insert the tip of the alligator clamps, tweezers, hemostats or crochet hook into the eyelet, grasp the buttonette and pull through the eyelet. Or a stiletto could be used to push the buttonette through the eyelet.

Diagram 1

