

HOLLY JOLLY ORNAMENTS & ACCENTS



Fits hoop sizes 5" x 7" and larger

THREAD LIST



Isacord Thread Colors

0010 Silky White
 0015 White
 0020 Black
 1161 Straw
 1900 Geranium

2011 Fire Engine
 2051 Teaberry
 2101 Country Red
 3963 Hint of Blue
 4071 Glacier Green

4250 Snomoon
 5643 Green Dust
 5833 Limabean

DESIGNS

Note: Some designs in this collection may have been created using unique special stitches and/or techniques. To preserve design integrity when rescaling or rotating designs in your software, always rescale or rotate designs using the handles directly on-screen.

*Fabric Required



12835-01 Santa Ornament FSA

Size Inches:	Size mm:	Stitch Count:
5.49 X 4.06 in.	139.0 X 103.1 mm	25222 St.

- 1. Red Fabric Placement Stitch..... 2101
- 2. Cut Line and Tackdown..... 2101
- 3. Tan Fabric Placement Stitch..... 0010
- 4. Cut Line and Tackdown..... 0010
- 5. Hat Shading..... 2101
- 6. Loop and Eyes..... 0020
- 7. Skin Shading..... 2051
- 8. White Detail and Lace..... 0010
- 9. Hat Cover Stitch..... 1900
- 10. Nose Detail..... 2101

Note: Some designs in this collection may have been created using unique special stitches and/or techniques. To preserve design integrity when rescaling or rotating designs in your software, always rescale or rotate designs using the handles directly on-screen.

***Fabric Required**

12835-02 Mrs Claus Ornament FSA

Size Inches: Size mm: Stitch Count:
3.54 X 3.73 in. **89.9 X 94.7 mm** **19511 St.**



	1. Red Fabric Placement Stitch.....	2101
	2. Cut Line and Tackdown.....	2101
	3. Tan Fabric Placement Stitch.....	2051
	4. Cut Line and Tackdown.....	2051
	5. Face/Cover Stitches and Detail.....	2051
	6. Nose Detail.....	2101
	7. Face Detail and Loop.....	0020
	8. White Detail and Lace.....	0010
	9. Hat Shading and Berries.....	2101
	10. Hat Cover Stitch and Berries.....	1900
	11. Blue Detail.....	3963
	12. Leaves.....	5833
	13. Leaf Detail.....	5643

***Fabric Required**

12835-03 Elf Ornament FSA

Size Inches: Size mm: Stitch Count:
3.82 X 4.17 in. **97.0 X 105.9 mm** **15160 St.**



	1. Red Fabric Placement Stitch.....	2101
	2. Cut Line and Tackdown.....	2101
	3. Tan Fabric Placement Stitch.....	2051
	4. Cut Line and Tackdown.....	2051
	5. Face Detail and Cover Stitch.....	2051
	6. Face Detail.....	2101
	7. Eyes and Loop.....	0020
	8. Hat Shading.....	2101
	9. Red Hat Cover Stitch.....	1900
	10. Tan Lace.....	1161
	11. Eye Highlights.....	0010
	12. Green Lace.....	5833

Note: Some designs in this collection may have been created using unique special stitches and/or techniques. To preserve design integrity when rescaling or rotating designs in your software, always rescale or rotate designs using the handles directly on-screen.

***Fabric Required**



12835-04 Tree Words Ornament FSA

Size Inches:	Size mm:	Stitch Count:
5.58 X 4.42 in.	141.7 X 112.3 mm	29702 St.
 1. Dark Green Fabric Placement Stitch.....		5833
 2. Cut Line and Tackdown		5833
 3. Green Lace and Cover Stitch		5833
 4. White Words.....		0010
 5. Inside Green Detail.....		5833
 6. Berries		1900

***Fabric Required**



12835-05 Tree Ornament FSA

Size Inches:	Size mm:	Stitch Count:
5.58 X 4.42 in.	141.7 X 112.3 mm	20496 St.
 1. Dark Green Fabric Placement Stitch.....		5833
 2. Cut Line and Tackdown		5833
 3. Green Lace and Cover Stitch		5833

Note: Some designs in this collection may have been created using unique special stitches and/or techniques. To preserve design integrity when rescaling or rotating designs in your software, always rescale or rotate designs using the handles directly on-screen.

***Fabric Required**



12835-06 Fancy Ornament FSA

Size Inches: Size mm: Stitch Count:
4.51 X 3.87 in. 114.6 X 98.3 mm 18029 St.

- 1. Dark Green Fabric Placement Stitch 5833
- 2. Cut Line and Tackdown 5833
- 3. Green Lace and Cover Stitch 5833
- 4. White Detail 0010
- 5. Blue Detail 3963
- 6. Red Detail 1900

***Fabric Required**



12835-07 Car Snow Globe Ornament FSA

Size Inches: Size mm: Stitch Count:
5.27 X 4.12 in. 133.9 X 104.6 mm 26506 St.

- 1. White Fabric Placement Stitch 4250
- 2. Cut Line and Tackdown 4250
- 3. Blue Shading 3963
- 4. White Lace 0010
- 5. Cover Stitch 4250
- 6. Dark Green Lace 5643
- 7. Car 1900
- 8. Tan Detail 1161
- 9. Tree 5833
- 10. Black Car Detail 0020
- 11. White Lace and Detail 0010

Note: Some designs in this collection may have been created using unique special stitches and/or techniques. To preserve design integrity when rescaling or rotating designs in your software, always rescale or rotate designs using the handles directly on-screen.

***Fabric Required**



12835-08 Snow Globe Ornament FSA

Size Inches: Size mm: Stitch Count:
5.27 X 4.12 in. 133.9 X 104.6 mm 13855 St.

- 1. White Fabric Placement Stitch 4250
- 2. Cut Line and Tackdown 4250
- 3. Blue Shading 3963
- 4. Cover Stitch and Detail 4250
- 5. Dark Green Lace 5643
- 6. White Detail 0015

12835-09 Snowflake Ornament 1 FSL

Size Inches: Size mm: Stitch Count:
4.25 X 3.73 in. 108.0 X 94.7 mm 23475 St.

- 1. Single Color Design 0010



Note: Some designs in this collection may have been created using unique special stitches and/or techniques. To preserve design integrity when rescaling or rotating designs in your software, always rescale or rotate designs using the handles directly on-screen.



12835-10 Snowflake Ornament 2 FSL

Size Inches:	Size mm:	Stitch Count:
3.71 X 3.29 in.	94.2 X 83.6 mm	16077 St.

1. Single Color Design..... 0010



12835-11 Snowflake Ornament 3 FSL

Size Inches:	Size mm:	Stitch Count:
3.28 X 2.90 in.	83.3 X 73.7 mm	13201 St.



1. Single Color Design..... 0010

Note: Some designs in this collection may have been created using unique special stitches and/or techniques. To preserve design integrity when rescaling or rotating designs in your software, always rescale or rotate designs using the handles directly on-screen.

***Fabric Required**





12835-12 Poinsettia Petals 1 FSA

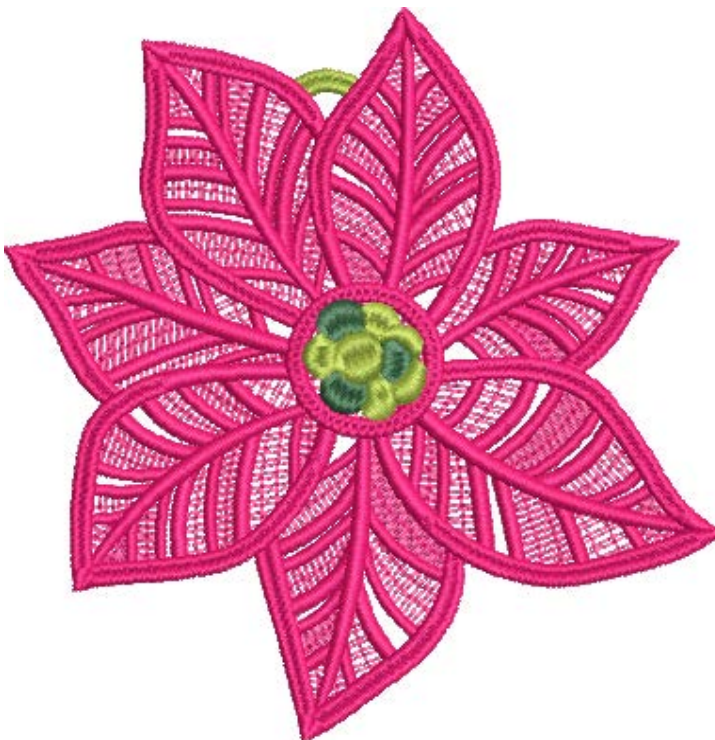

Size Inches:	Size mm:	Stitch Count:
2.78 X 2.60 in.	70.6 X 66.0 mm	4446 St.
 1. Red Fabric Placement Stitch.....		1900
 2. Cut Line and Tackdown.....		1900
 3. Cover Stitch and Center Mark.....		1900

12835-13 Poinsettia Petals 2 FSL



Size Inches:	Size mm:	Stitch Count:
4.57 X 4.46 in.	116.1 X 113.3 mm	28559 St.
 1. Eyelet.....		5833
 2. Red Lace.....		1900
 3. Center Mark.....		1900
 4. Dark Green Berries.....		5643
 5. Light Green Berries.....		5833

Note: Some designs in this collection may have been created using unique special stitches and/or techniques. To preserve design integrity when rescaling or rotating designs in your software, always rescale or rotate designs using the handles directly on-screen.

***Fabric Required**

12835-14 Cardinal Ornament Body FSA

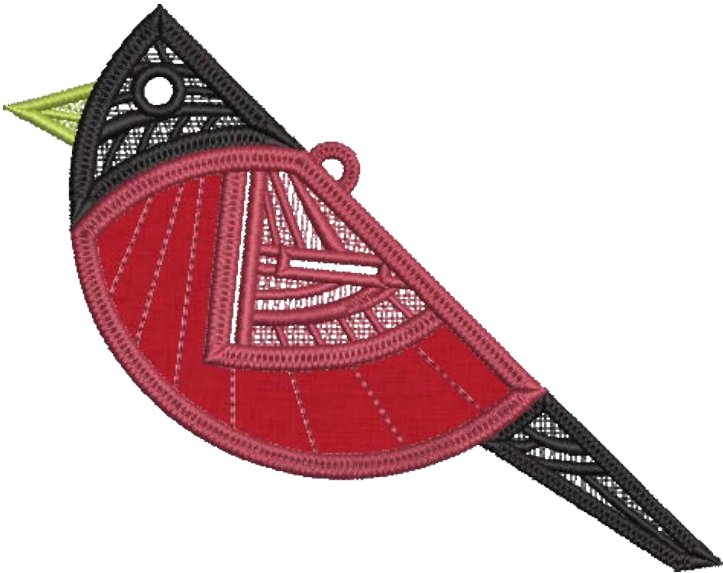

Size Inches: Size mm: Stitch Count:
4.36 X 5.49 in. 110.7 X 139.4 mm 14281 St.

-  1. Front and Back Red Fabric Placement Stitch .2011
-  2. Cut Line and Tackdown2011
-  3. Green Lace..... 5833
-  4. Black Lace..... 0020
-  5. Red Lace and Cover Stitch2011



12835-15 Cardinal Ornament Wings FSL

Size Inches: Size mm: Stitch Count:
5.64 X 1.29 in. 143.3 X 32.8 mm 15539 St.

-  1. White Lace 0015
-  2. Black Lace..... 0020
-  3. Green Lace..... 5833



Note: Some designs in this collection may have been created using unique special stitches and/or techniques. To preserve design integrity when rescaling or rotating designs in your software, always rescale or rotate designs using the handles directly on-screen.

12835-16 Cardinal Ornament Wings Brace FSL

Size Inches: Size mm: Stitch Count:
0.51 X 1.23 in. **13.0 X 31.2 mm** **1625 St.**

- 1. Single Color Design..... 5833

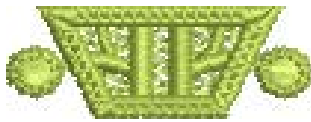

*Fabric Required



12835-17 Mini Box Ornament FSA

Size Inches: Size mm: Stitch Count:
7.41 X 5.71 in. **188.2 X 145.0 mm** **28578 St.**

- 1. Light Green Fabric Placement Stitch..... 1161
- 2. Cut Line and Tackdown 1161
- 3. Dark Green Fabric Placement Stitch..... 1161
- 4. Cut Line and Tackdown 1161
- 5. Red Fabric Placement Stitch..... 1161
- 6. Cut Line and Tackdown 1161
- 7. White Fabric Placement Stitch 1161
- 8. Cut Line and Tackdown 1161
- 9. Eyelet 5643
- 10. Lace and Cover Stitch 1161
- 11. Light Green Detail 5833
- 12. Dark Green Detail..... 5643
- 13. White Detail..... 0010
- 14. Red Detail..... 1900
- 15. Maroon Detail 2101

Note: Some designs in this collection may have been created using unique special stitches and/or techniques. To preserve design integrity when rescaling or rotating designs in your software, always rescale or rotate designs using the handles directly on-screen.

***Fabric Required**



12835-18 Box Ornament FSA

Size Inches: **9.16 X 7.07 in.** Size mm: **232.7 X 179.6 mm** Stitch Count: **36166 St.**

- 1. Light Green Fabric Placement Stitch..... 1161
- 2. Cut Line and Tackdown 1161
- 3. Dark Green Fabric Placement Stitch..... 1161
- 4. Cut Line and Tackdown 1161
- 5. Red Fabric Placement Stitch..... 1161
- 6. Cut Line and Tackdown 1161
- 7. White Fabric Placement Stitch 1161
- 8. Cut Line and Tackdown 1161
- 9. Lace and Cover Stitch 1161
- 10. Light Green Detail 5833
- 11. Dark Green Detail and Eyelet..... 5643
- 12. White Detail 0010
- 13. Red Detail..... 1900
- 14. Maroon Detail 2101

***Fabric Required**

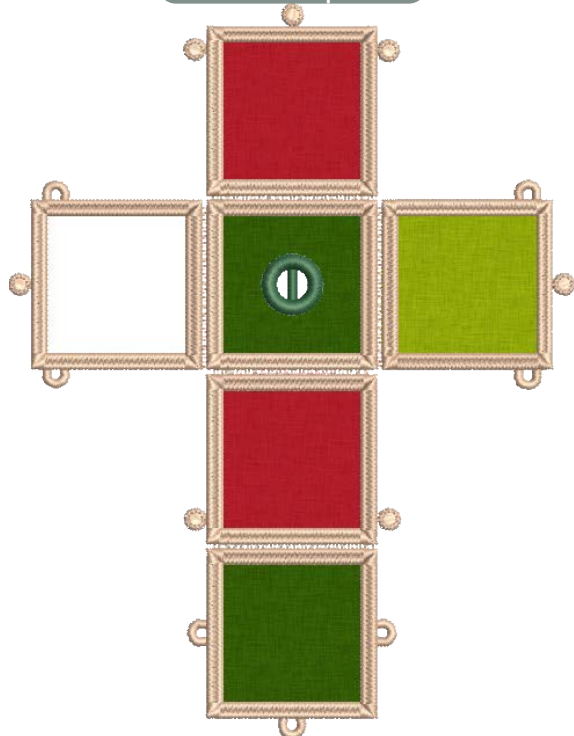

12835-19 Mini Blank Box Ornament

Size Inches: **7.45 X 5.71 in.** Size mm: **189.2 X 145.0 mm** Stitch Count: **17566 St.**

- 1. Dark Green Fabric Placement Stitch..... 1161
- 2. Cut Line and Tackdown 1161
- 3. Red Fabric Placement Stitch..... 1161
- 4. Cut Line and Tackdown 1161
- 5. White Fabric Placement Stitch 1161
- 6. Cut Line and Tackdown 1161
- 7. Light Green Fabric Placement Stitch..... 1161
- 8. Cut Line and Tackdown 1161
- 9. Lace and Cover Stitch 1161
- 10. Dark Green Eyelet..... 5643

Note: Some designs in this collection may have been created using unique special stitches and/or techniques. To preserve design integrity when rescaling or rotating designs in your software, always rescale or rotate designs using the handles directly on-screen.

***Fabric Required**

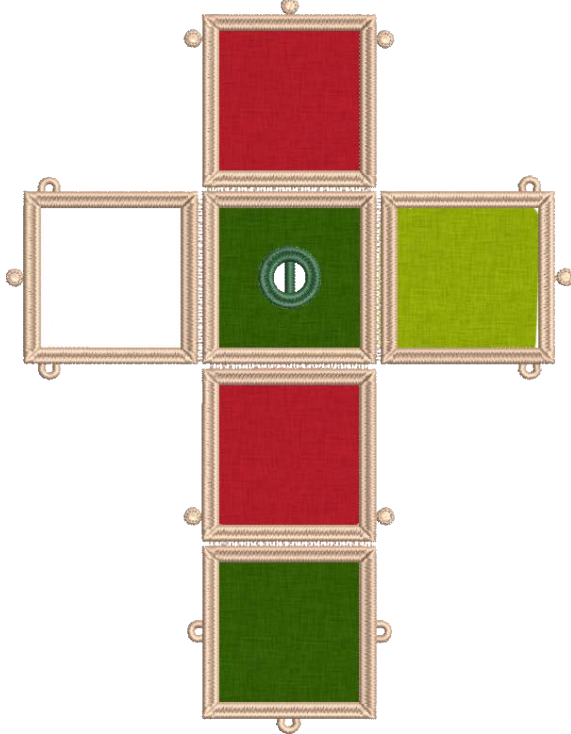

12835-20 Blank Box Ornament

Size Inches: Size mm: Stitch Count:
9.17 X 7.03 in. 232.9 X 178.6 mm 22186 St.

- 1. Dark Green Fabric Placement Stitch..... 1161
- 2. Cut Line and Tackdown 1161
- 3. Red Fabric Placement Stitch..... 1161
- 4. Cut Line and Tackdown 1161
- 5. White Fabric Placement Stitch 1161
- 6. Cut Line and Tackdown 1161
- 7. Light Green Fabric Placement Stitch..... 1161
- 8. Cut Line and Tackdown 1161
- 9. Lace and Cover Stitch 1161
- 10. Dark Green Eyelet..... 5643

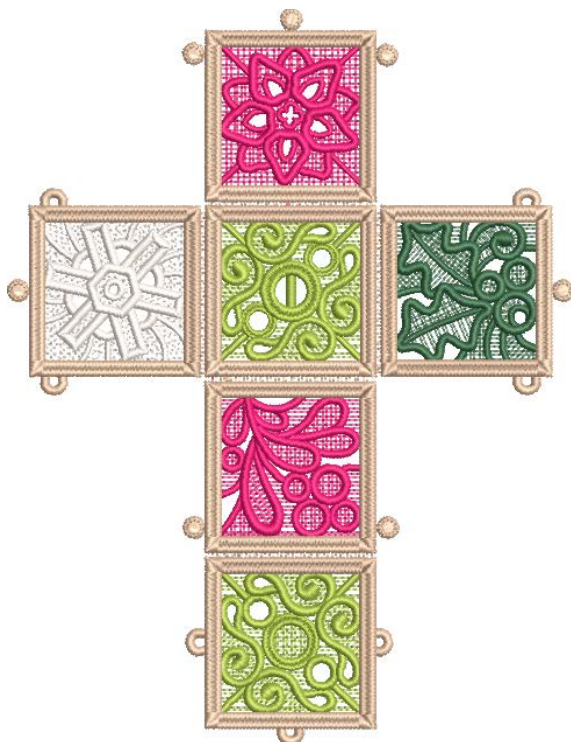

12835-21 Mini Lace Box Ornament FSL

Size Inches: Size mm: Stitch Count:
7.40 X 5.69 in. 188.0 X 144.5 mm 50377 St.

- 1. Red Lace 1900
- 2. Light Green Lace..... 5833
- 3. Dark Green Lace 5643
- 4. White Lace 0010
- 5. Tan Lace..... 1161

Note: Some designs in this collection may have been created using unique special stitches and/or techniques. To preserve design integrity when rescaling or rotating designs in your software, always rescale or rotate designs using the handles directly on-screen.

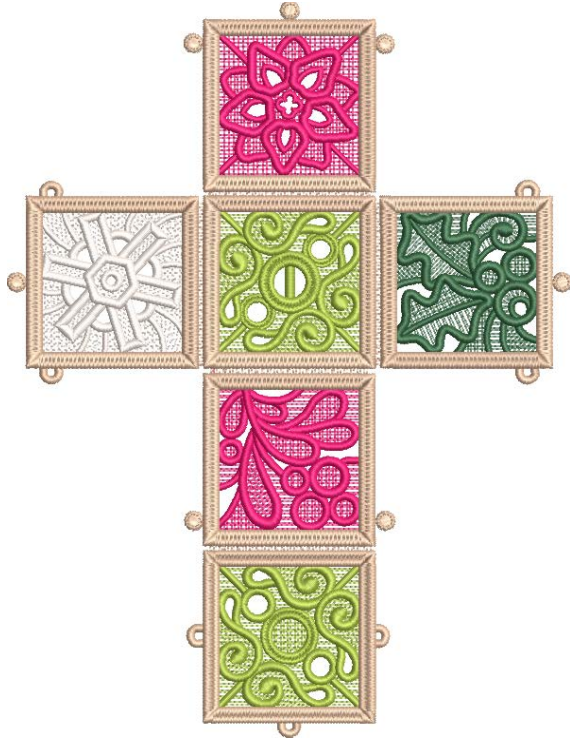

12835-22 Lace Box Ornament FSL

Size Inches: Size mm: Stitch Count:
9.08 X 6.97 in. 230.6 X 177.0 mm 65898 St.

- 1. Red Lace 1900
- 2. Light Green Lace 5833
- 3. Dark Green Lace 5643
- 4. White Lace 0010
- 5. Tan Lace 1161

***Fabric Required**

12835-23 Light Box J Front FSA

Size Inches: Size mm: Stitch Count:
3.04 X 3.46 in. 77.2 X 87.9 mm 13665 St.

- 1. Dark Green Fabric Placement Stitch 1161
- 2. Cut Line and Tackdown 1161
- 3. Green Background 5643
- 4. Red Lace 1900
- 5. Tan Lace and Cover Stitch 1161



Note: Some designs in this collection may have been created using unique special stitches and/or techniques. To preserve design integrity when rescaling or rotating designs in your software, always rescale or rotate designs using the handles directly on-screen.

***Fabric Required**

12835-24 Light Box O Front FSA

Size Inches: Size mm: Stitch Count:
3.04 X 3.46 in. 77.2 X 87.9 mm 14698 St.

- 1. White Fabric Placement Stitch 1161
- 2. Cut Line and Tackdown 1161
- 3. Light Gray Detail..... 4071
- 4. Green Lace..... 5643
- 5. Tan Lace and Cover Stitch 1161

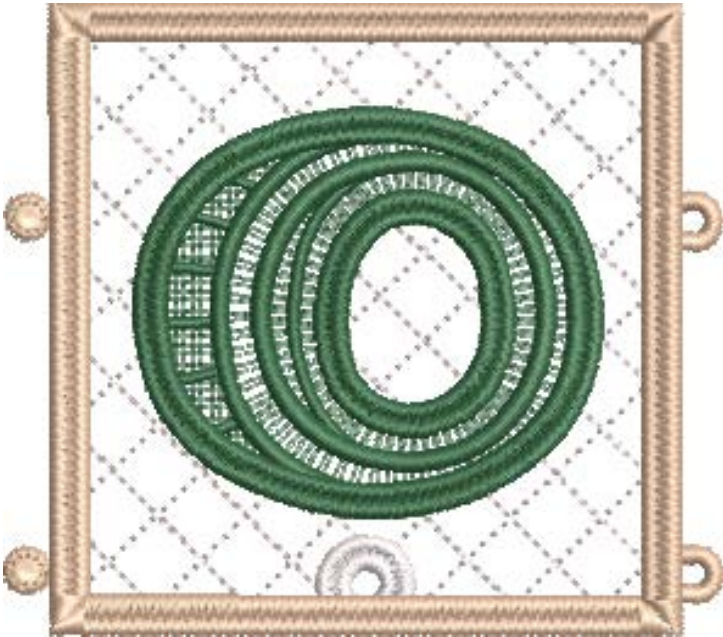

***Fabric Required**

12835-25 Light Box Y Front FSA

Size Inches: Size mm: Stitch Count:
3.04 X 3.46 in. 77.2 X 87.9 mm 13303 St.

- 1. Red Fabric Placement Stitch 1161
- 2. Cut Line and Tackdown 1161
- 3. Red Detail..... 1900
- 4. Light Green Lace..... 5833
- 5. Tan Lace and Cover Stitch 1161



Note: Some designs in this collection may have been created using unique special stitches and/or techniques. To preserve design integrity when rescaling or rotating designs in your software, always rescale or rotate designs using the handles directly on-screen.

***Fabric Required**

12835-26 Light Box Tree Side FSA



Size Inches: Size mm: Stitch Count:
3.06 X 3.47 in. 77.7 X 88.1 mm 12315 St.

- 1. White Fabric Placement Stitch 1161
- 2. Cut Line and Tackdown 1161
- 3. Gray Detail 4071
- 4. Green Lace..... 5643
- 5. Tan Lace and Cover Stitch 1161

***Fabric Required**

12835-27 Light Box Snowflake Side FSA



Size Inches: Size mm: Stitch Count:
3.04 X 3.46 in. 77.2 X 87.9 mm 13479 St.





- 1. Green Fabric Placement Stitch 1161
- 2. Cut Line and Tackdown 1161
- 3. Dark Green Detail..... 5643
- 4. White Lace 0010
- 5. Tan Lace and Cover Stitch 1161

Note: Some designs in this collection may have been created using unique special stitches and/or techniques. To preserve design integrity when rescaling or rotating designs in your software, always rescale or rotate designs using the handles directly on-screen.

***Fabric Required**

12835-28 Light Box Bell Side FSA



Size Inches:	Size mm:	Stitch Count:
3.04 X 3.46 in.	77.2 X 87.9 mm	12403 St.
 1. Red Fabric Placement Stitch.....		1161
 2. Cut Line and Tackdown		1161
 3. Red Detail.....		1900
 4. Green Lace.....		5833
 5. Tan Lace and Cover Stitch		1161

***Fabric Required**

12835-29 Light Box Star Side FSA



Size Inches:	Size mm:	Stitch Count:
3.04 X 3.46 in.	77.2 X 77.4 mm	12266 St.
 1. Dark Green Fabric Placement Stitch.....		1161
 2. Cut Line and Tackdown		1161
 3. Dark Green Detail.....		5643
 4. Red Lace		1900
 5. Tan Lace and Cover Stitch		1161

Note: Some designs in this collection may have been created using unique special stitches and/or techniques. To preserve design integrity when rescaling or rotating designs in your software, always rescale or rotate designs using the handles directly on-screen.

***Fabric Required**



12835-30 Light Box Bow Top FSA

Size Inches: Size mm: Stitch Count:
3.04 X 3.04 in. **77.2 X 77.2 mm** **13612 St.**

- 1. Green Fabric Placement Stitch 1161
- 2. Cut Line and Tackdown 1161
- 3. Dark Green Detail..... 5643
- 4. Red Lace..... 1900
- 5. Tan Lace and Cover Stitch 1161

***Fabric Required**

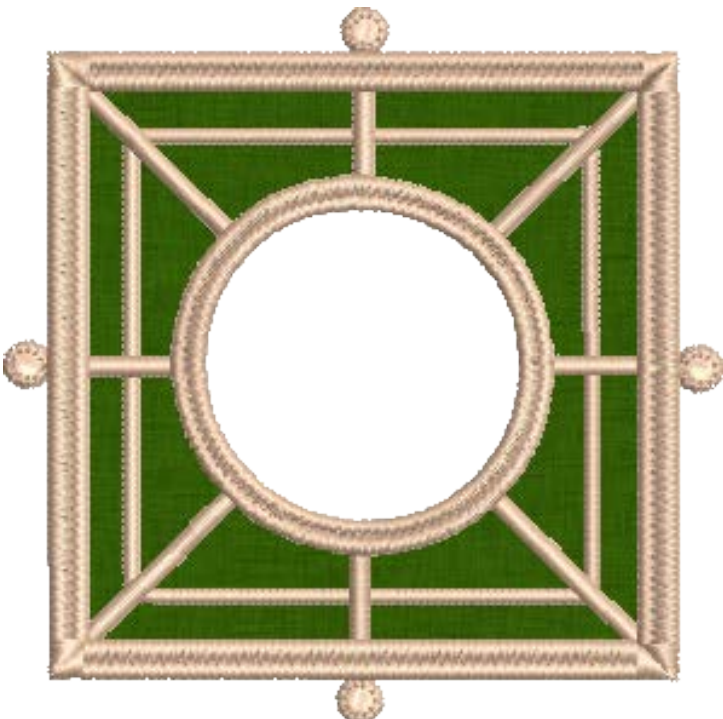

12835-31 Light Box Base FSA

Size Inches: Size mm: Stitch Count:
3.47 X 3.48 in. **88.1 X 88.4 mm** **8803 St.**

- 1. Dark Green Fabric Placement Stitch..... 1161
- 2. Cut Line and Tackdown 1161
- 3. Tan Lace and Cover Stitch 1161

Note: Some designs in this collection may have been created using unique special stitches and/or techniques. To preserve design integrity when rescaling or rotating designs in your software, always rescale or rotate designs using the handles directly on-screen.

***Fabric Required**

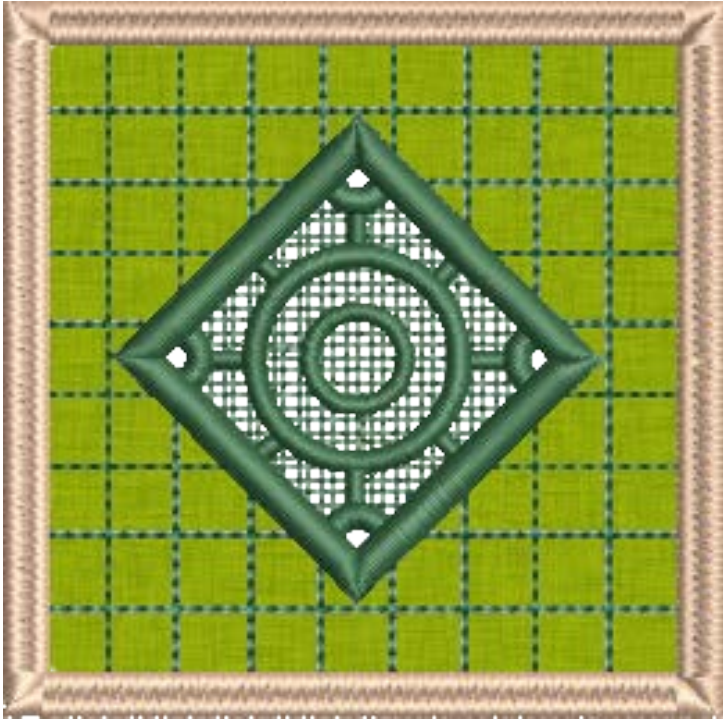

12835-32 Light Box Top For Bow FSA

Size Inches: Size mm: Stitch Count:
3.04 X 3.04 in. 77.2 X 77.2 mm 9843 St.

- 1. Green Fabric Placement Stitch1161
- 2. Cut Line and Tackdown1161
- 3. Green Detail5643
- 4. Tan Lace and Cover Stitch1161



12835-33 Light Box Bow FSL

Size Inches: Size mm: Stitch Count:
9.56 X 2.40 in. 242.8 X 61.0 mm 39103 St.

- 1. Single Color Design.....2011

Note: Some designs in this collection may have been created using unique special stitches and/or techniques. To preserve design integrity when rescaling or rotating designs in your software, always rescale or rotate designs using the handles directly on-screen.

***Fabric Required**

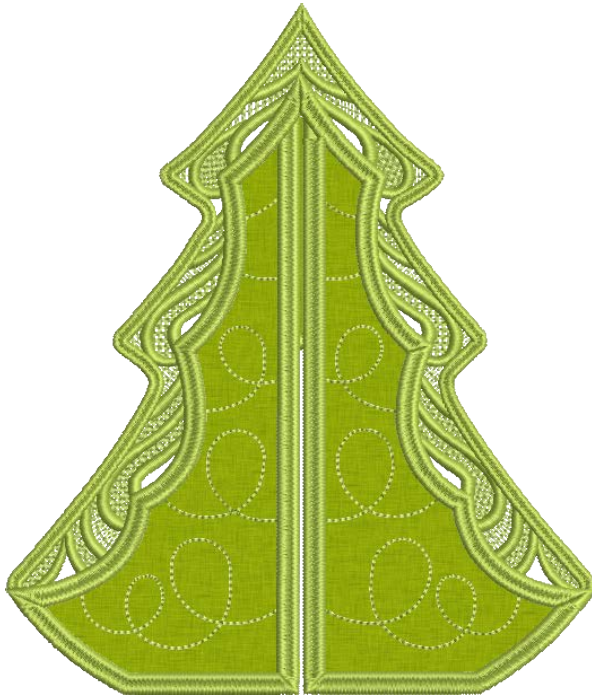

12835-34 Small Flared Tree Section 1 FSA

Size Inches:	Size mm:	Stitch Count:
6.25 X 5.29 in.	158.8 X 134.4 mm	25050 St.

- 1. Front and Back Light Green Fabric Placement Stitch . 5833
- 2. Cut Line and Tackdown 5833
- 3. Green Lace and Cover Stitch 5833

***Fabric Required**



12835-35 Small Flared Tree Section 2 FSA

Size Inches:	Size mm:	Stitch Count:
6.00 X 5.28 in.	152.4 X 134.1 mm	25480 St.

- 1. Front and Back Light Green Fabric Placement Stitch . 5833
- 2. Cut Line and Tackdown 5833
- 3. Green Lace and Cover Stitch 5833

Note: Some designs in this collection may have been created using unique special stitches and/or techniques. To preserve design integrity when rescaling or rotating designs in your software, always rescale or rotate designs using the handles directly on-screen.

***Fabric Required**

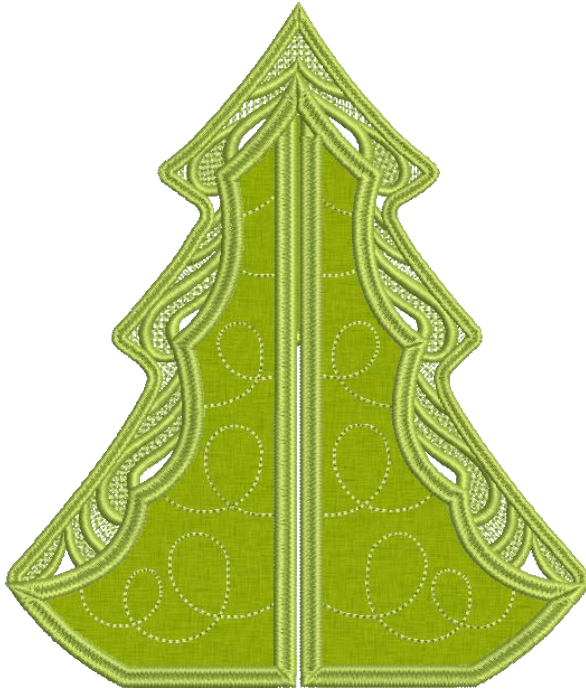

12835-36 Medium Flared Tree Section 1 FSA

Size Inches:	Size mm:	Stitch Count:
7.19 X 6.09 in.	182.6 X 154.7 mm	30351 St.

- 1. Front and Back Light Green Fabric Placement Stitch . 5833
- 2. Cut Line and Tackdown 5833
- 3. Green Lace and Cover Stitch 5833

***Fabric Required**

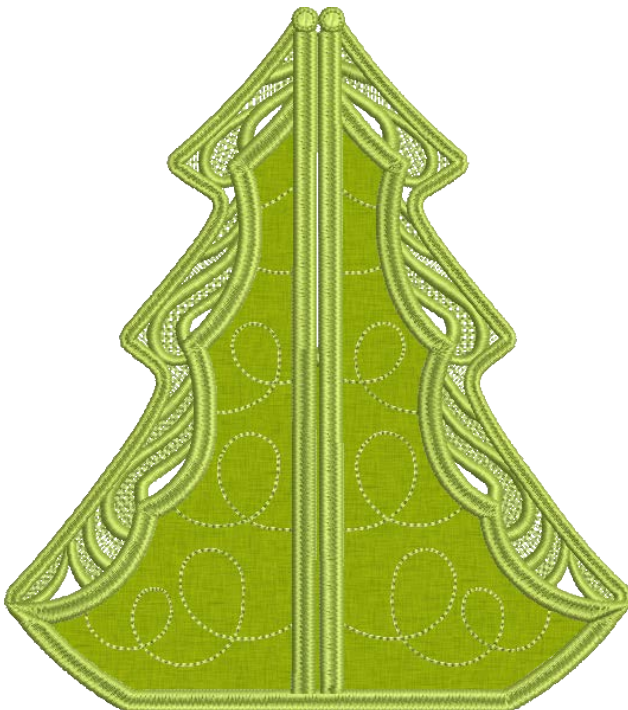

12835-37 Medium Flared Tree Section 2 FSA

Size Inches:	Size mm:	Stitch Count:
7.00 X 6.18 in.	177.8 X 157.0 mm	31355 St.

- 1. Front and Back Light Green Fabric Placement Stitch . 5833
- 2. Cut Line and Tackdown 5833
- 3. Green Lace and Cover Stitch 5833

Note: Some designs in this collection may have been created using unique special stitches and/or techniques. To preserve design integrity when rescaling or rotating designs in your software, always rescale or rotate designs using the handles directly on-screen.

***Fabric Required**

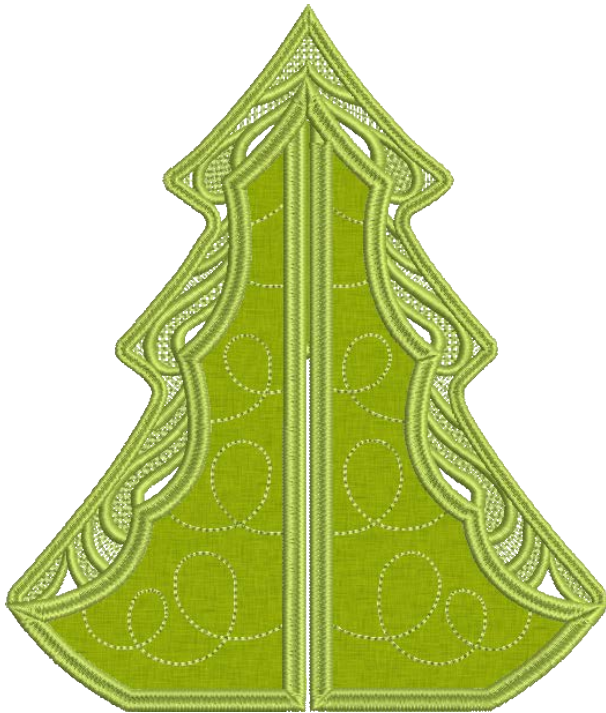

12835-38 Large Flared Tree Section 1 FSA

Size Inches: Size mm: Stitch Count:
8.33 X 7.03 in. 211.6 X 178.6 mm 36019 St.

- 1. Front and Back Light Green Fabric Placement Stitch . 5833
- 2. Cut Line and Tackdown 5833
- 3. Green Lace and Cover Stitch 5833

***Fabric Required**

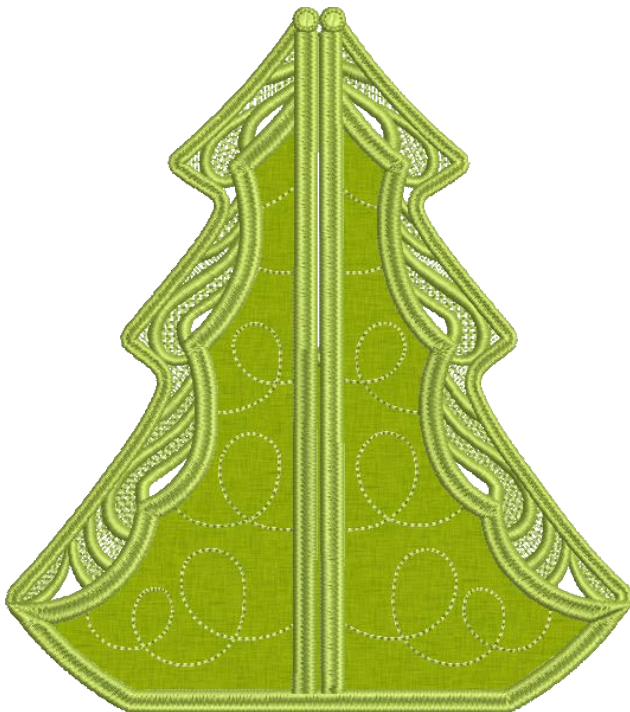

12835-39 Large Flared Tree Section 2 FSA

Size Inches: Size mm: Stitch Count:
8.07 X 7.10 in. 205.0 X 180.3 mm 37179 St.

- 1. Front and Back Light Green Fabric Placement Stitch . 5833
- 2. Cut Line and Tackdown 5833
- 3. Green Lace and Cover Stitch 5833

Note: Some designs in this collection may have been created using unique special stitches and/or techniques. To preserve design integrity when rescaling or rotating designs in your software, always rescale or rotate designs using the handles directly on-screen.

***Fabric Required**

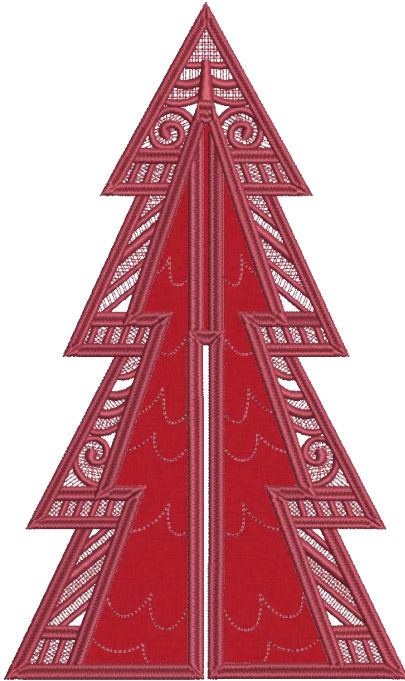

12835-40 Small Woodland Tree Section 1 FSA

Size Inches:	Size mm:	Stitch Count:
7.60 X 4.51 in.	193.0 X 114.6 mm	32709 St.

- 1. Front and Back Red Fabric Placement Stitch ...2011
- 2. Cut Line and Tackdown2011
- 3. Lace and Cover Stitch2011

***Fabric Required**

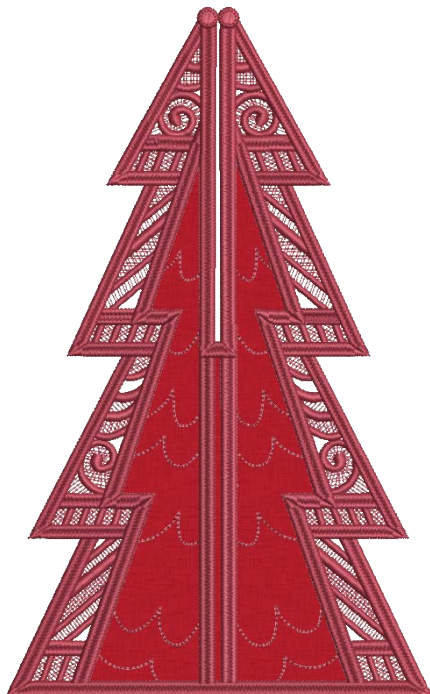

12835-41 Small Woodland Tree Section 2 FSA

Size Inches:	Size mm:	Stitch Count:
7.32 X 4.51 in.	185.9 X 114.6 mm	33568 St.

- 1. Front and Back Red Fabric Placement Stitch ...2011
- 2. Cut Line and Tackdown2011
- 3. Lace and Cover Stitch2011

Note: Some designs in this collection may have been created using unique special stitches and/or techniques. To preserve design integrity when rescaling or rotating designs in your software, always rescale or rotate designs using the handles directly on-screen.

***Fabric Required**

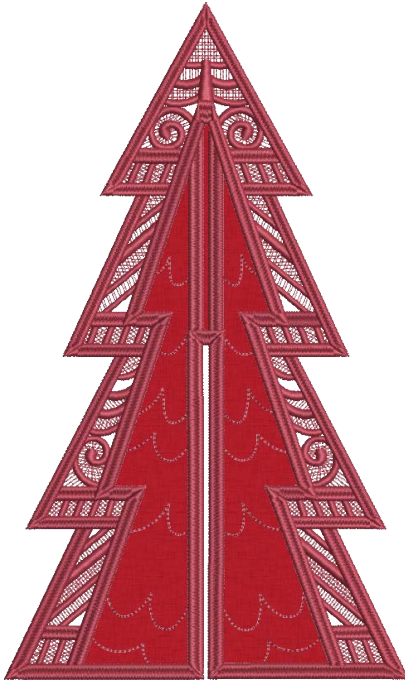

12835-42 Medium Woodland Tree Section 1 FSA

Size Inches:	Size mm:	Stitch Count:
9.61 X 5.70 in.	244.1 X 144.8 mm	43682 St.

- 1. Front and Back Red Fabric Placement Stitch ...2011
- 2. Cut Line and Tackdown2011
- 3. Lace and Cover Stitch2011

***Fabric Required**

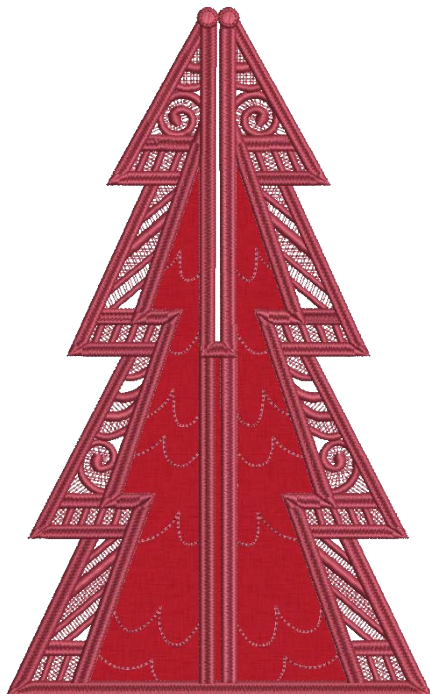

12835-43 Medium Woodland Tree Section 2 FSA

Size Inches:	Size mm:	Stitch Count:
9.25 X 5.70 in.	235.0 X 144.8 mm	44595 St.

- 1. Front and Back Red Fabric Placement Stitch ...2011
- 2. Cut Line and Tackdown2011
- 3. Lace and Cover Stitch2011

Note: Some designs in this collection may have been created using unique special stitches and/or techniques. To preserve design integrity when rescaling or rotating designs in your software, always rescale or rotate designs using the handles directly on-screen.

***Fabric Required**

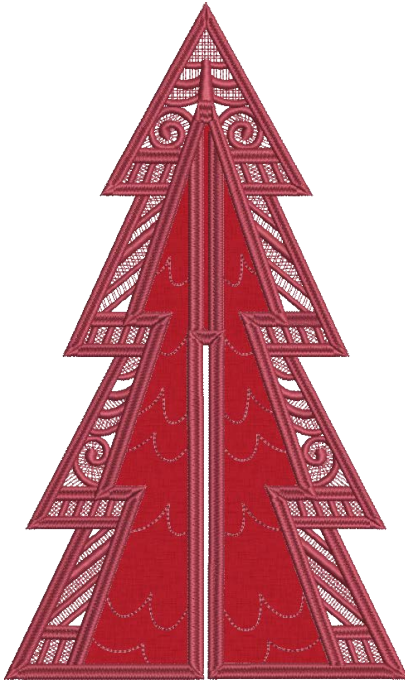

12835-44 Large Woodland Tree Section 1 FSA

Size Inches: Size mm: Stitch Count:
11.06 X 6.56 in. 280.9 X 166.6 mm 52125 St.

- 1. Front and Back Red Fabric Placement Stitch ...2011
- 2. Cut Line and Tackdown2011
- 3. Lace and Cover Stitch2011

***Fabric Required**

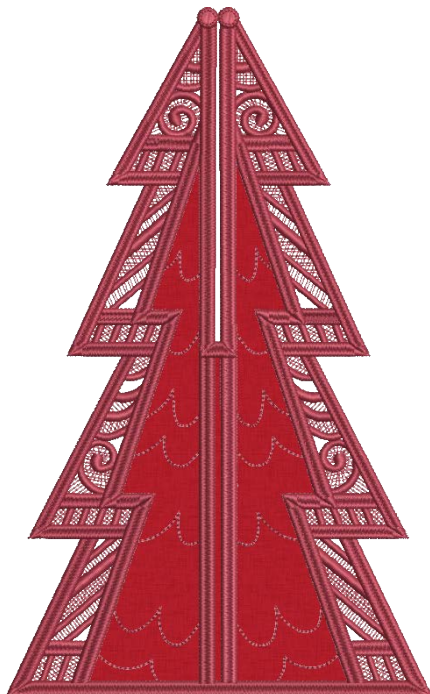

12835-45 Large Woodland Tree Section 2 FSA

Size Inches: Size mm: Stitch Count:
10.61 X 6.54 in. 269.5 X 166.1 mm 52530 St.

- 1. Front and Back Red Fabric Placement Stitch ...2011
- 2. Cut Line and Tackdown2011
- 3. Lace and Cover Stitch2011

Note: Some designs in this collection may have been created using unique special stitches and/or techniques. To preserve design integrity when rescaling or rotating designs in your software, always rescale or rotate designs using the handles directly on-screen.

***Fabric Required**

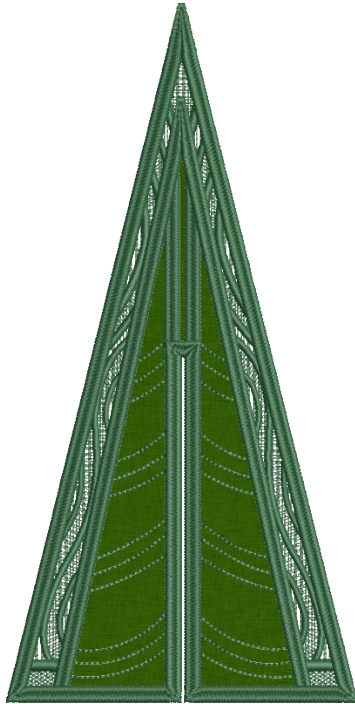

12835-46 Small Modern Tree Section 1 FSA

Size Inches:	Size mm:	Stitch Count:
7.68 X 3.85 in.	195.1 X 97.8 mm	23743 St.

- 1. Front and Back Dark Green Fabric Placement Stitch . 5643
- 2. Cut Line and Tackdown 5643
- 3. Lace and Cover Stitch 5643

***Fabric Required**

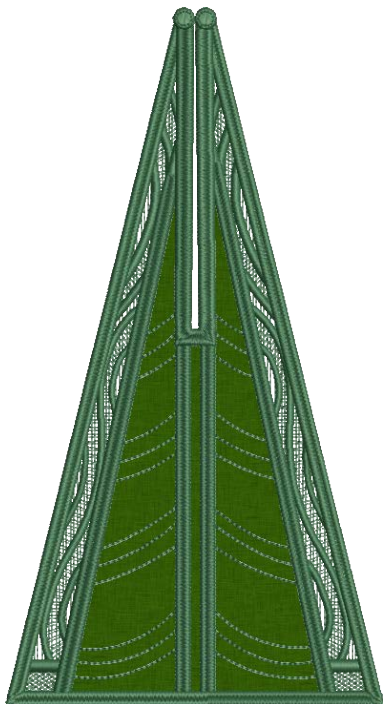

12835-47 Small Modern Tree Section 2 FSA

Size Inches:	Size mm:	Stitch Count:
7.04 X 3.80 in.	178.8 X 96.5 mm	22736 St.

- 1. Front and Back Dark Green Fabric Placement Stitch . 5643
- 2. Cut Line and Tackdown 5643
- 3. Lace and Cover Stitch 5643

Note: Some designs in this collection may have been created using unique special stitches and/or techniques. To preserve design integrity when rescaling or rotating designs in your software, always rescale or rotate designs using the handles directly on-screen.

***Fabric Required**

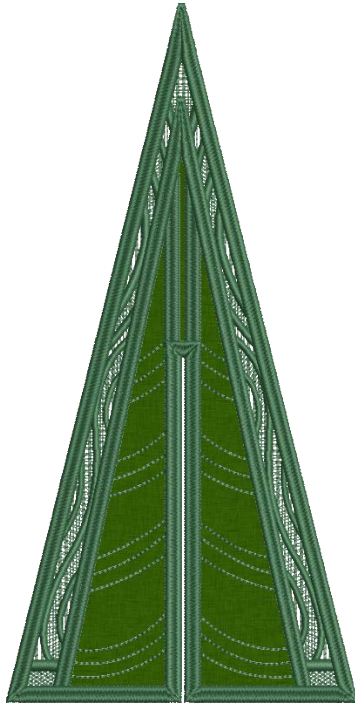

12835-48 Medium Modern Tree Section 1 FSA

Size Inches:	Size mm:	Stitch Count:
9.42 X 4.72 in.	239.3 X 119.9 mm	30464 St.

- 1. Front and Back Dark Green Fabric Placement Stitch . 5643
- 2. Cut Line and Tackdown 5643
- 3. Lace and Cover Stitch 5643

***Fabric Required**

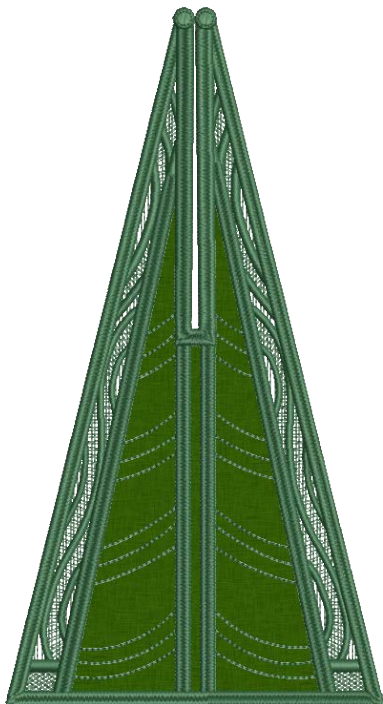

12835-49 Medium Modern Tree Section 2 FSA

Size Inches:	Size mm:	Stitch Count:
8.60 X 4.65 in.	218.4 X 118.1 mm	29433 St.

- 1. Front and Back Dark Green Fabric Placement Stitch . 5643
- 2. Cut Line and Tackdown 5643
- 3. Lace and Cover Stitch 5643

Note: Some designs in this collection may have been created using unique special stitches and/or techniques. To preserve design integrity when rescaling or rotating designs in your software, always rescale or rotate designs using the handles directly on-screen.

***Fabric Required**

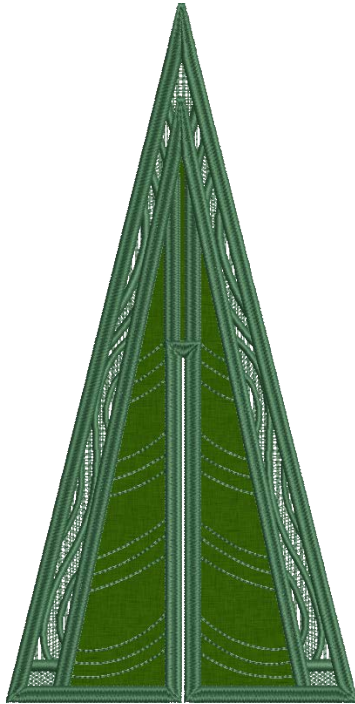

12835-50 Large Modern Tree Section 1 FSA

Size Inches:	Size mm:	Stitch Count:
11.02 X 5.52 in.	279.9 X 140.2 mm	43476 St.

- 1. Front and Back Dark Green Fabric Placement Stitch . 5643
- 2. Cut Line and Tackdown 5643
- 3. Lace and Cover Stitch 5643

***Fabric Required**

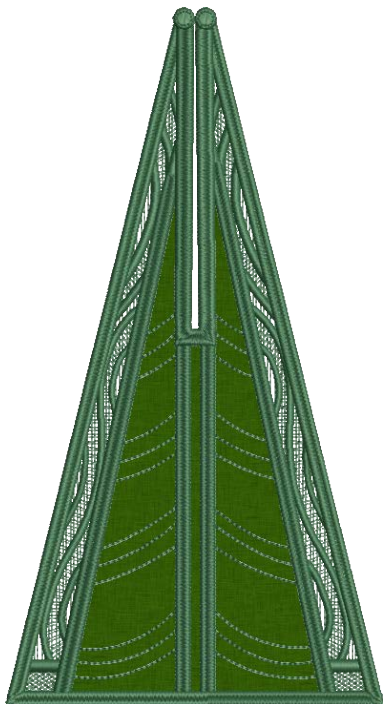

12835-51 Large Modern Tree Section 2 FSA

Size Inches:	Size mm:	Stitch Count:
10.01 X 5.41 in.	254.3 X 137.4 mm	35613 St.

- 1. Front and Back Dark Green Fabric Placement Stitch . 5643
- 2. Cut Line and Tackdown 5643
- 3. Lace and Cover Stitch 5643

COLLECTION SUPPLIES



Stabilizer

- AquaMesh WashAway
- BadgeMaster
- StabilStick CutAway (for backing applique fabric)

Supplies

- Alligator Clamps (recommended)
- Temporary Spray Adhesive
- Expert Embroidery Tape TearAway (optional)
- Fabric for applique (red, dark green, light green, white, tan)

ORNAMENT INSTRUCTIONS

12835-01 THROUGH 12835-08



STEP 1

- Prep fabric by applying 2 pieces of StabilStick CutAway to the wrong side of the fabric.
- Refer to templates for size.



STEP 2

- Hoop 1 layer of AquaMesh WashAway and 1 layer of BadgeMaster.
- Stitch Machine Step 1, the Placement Stitch.



STEP 3

- Lightly spray temporary adhesive on the wrong side of the fabric and place it directly over the placement stitch face up, covering it entirely.
- **Note:** Expert Embroidery Tape TearAway may be used as an alternative.



ORNAMENT INSTRUCTIONS

12835-01 THROUGH 12835-08



STEP 4

- Stitch Machine Step 2, Cut Line and Tackdown.



STEP 5

- Remove the hoop from the machine, but do not remove project from the hoop. Trim the fabric along the cut line.



STEP 6

- Follow Steps 3 through 5 for the next applique if necessary.



ORNAMENT INSTRUCTIONS

12835-01 THROUGH 12835-08

STEP 7

- Stitch the remaining machine steps, matching the bobbin with the top thread.
- Remove the project from the hoop and trim away excess stabilizer to $\frac{1}{8}$ " - $\frac{1}{4}$ " from design.
- Wash away the remaining stabilizer in warm running water.
- Lay flat face down to dry.



POINSETTIA INSTRUCTIONS

TOP PETALS 12835-12



STEP 1

- **Note:** Match all bobbin thread to top thread.
- Cut applique fabric and StabilStick CutAway slightly larger than needed. Refer to the templates for size.
- Prep 2 pieces of the applique fabric with one layer of StabilStick CutAway on each piece.

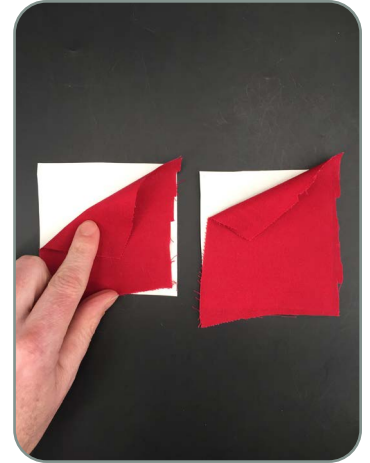

STEP 2

- Hoop one sheet of AquaMesh WashAway and one sheet of BadgeMaster.
- Stitch Machine Step 1, Front and Back Red Fabric Placement Stitch.



STEP 3

- With right side up, place front applique piece directly over the placement stitch, covering it entirely.
- Tape in place with Expert Embroidery Tape TearAway.
- Remove the hoop from the machine, but not the project from the hoop.



POINSETTIA INSTRUCTIONS

TOP PETALS 12835-12



STEP 4

- Flip the hoop over and repeat step 4 for the back-applique piece.



STEP 5

- Stitch Machine Step 2, Cut Line and Tackdown.



STEP 6

- Remove the hoop from the machine, DO NOT remove the design from the hoop. Trim along the cut line of the front applique.
- Flip the hoop over and trim along the cut line of the back applique.



POINSETTIA INSTRUCTIONS

TOP PETALS 12835-12



STEP 7

- Return the hoop to the machine and stitch the remaining machine steps to complete the design.



STEP 8

- Remove the design from the hoop and cut away the extra stabilizer ¼" from the design.
- Rinse the remaining stabilizer in warm running water and lay face down to dry.



POINSETTIA INSTRUCTIONS

BOTTOM PETALS 12835-13



STEP 1

- Hoop one sheet of AquaMesh WashAway and one sheet of BadgeMaster.

STEP 2

- Stitch the first 2 machine steps and stop after Red Lace. Make sure to match the bobbin to the top thread through out.



STEP 3

- Remove the hoop from the machine, DO NOT remove the design from the hoop.
- Use temporary spray adhesive and spray the bottom side of the design 12835-12. Place on top of design 12835-13 lining up the Center Mark stitch in the center of the designs. Put the hoop back on the machine.
- Stitch the remaining machine steps.

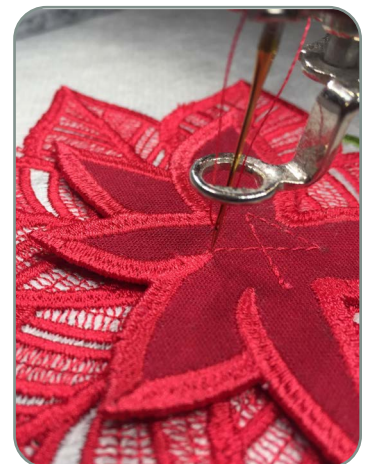

POINSETTIA INSTRUCTIONS

BOTTOM PETALS 12835-13



STEP 4

- Remove the design from the hoop and cut away the extra stabilizer ¼" from the design.
- Rinse the remaining stabilizer in warm water and lay face down to dry.



CARDINAL BODY APPLIQUE

12835-14



STEP 1

- **Note:** Match bobbin thread to top thread throughout.
- Cut two pieces of fabric slightly larger than needed for applique. Refer to the templates for size.
- Prep 2 pieces of the applique fabric with one layer of StabilStick CutAway applied to the back of each piece.

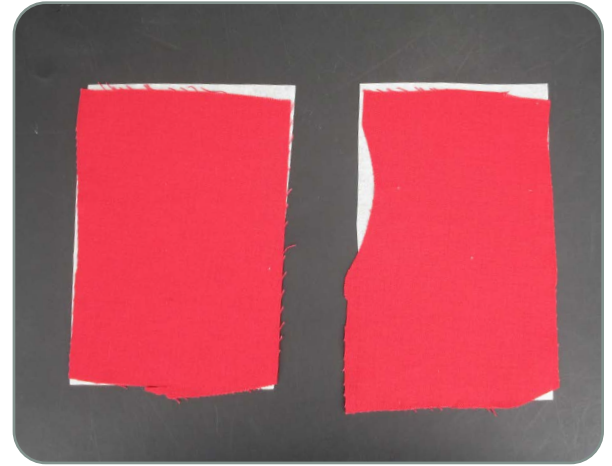

STEP 2

- Hoop one piece of AquaMesh WashAway and one piece of BadgeMaster.
- Stitch Machine Step 1, Front and Back Red Fabric Placement Stitch.



STEP 3

- Use temporary spray adhesive to spray the wrong side of the applique piece.
- Place the fabric right side up, directly over the placement stitch, covering it entirely.
- **Tip:** Expert Embroidery Tape TearAway can be used in place of spray.

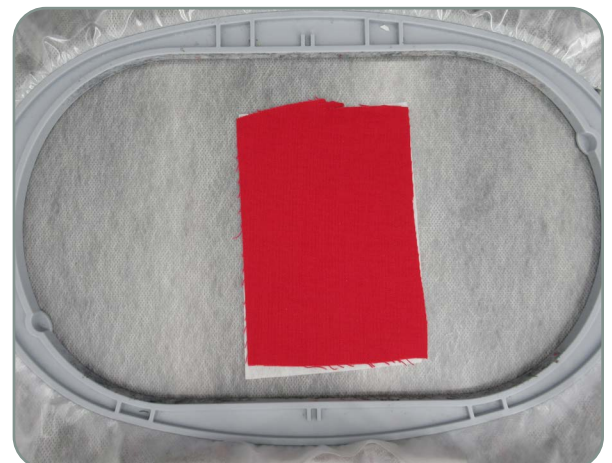

CARDINAL BODY APPLIQUE

12835-14



STEP 4

- Remove the hoop from the machine, do NOT remove the project from the hoop.
- Flip the hoop over and repeat step 3 for the back-applique piece.
- Place the hoop back on the machine.



STEP 5

- Stitch Machine Step 2, Cut Line and Tackdown.

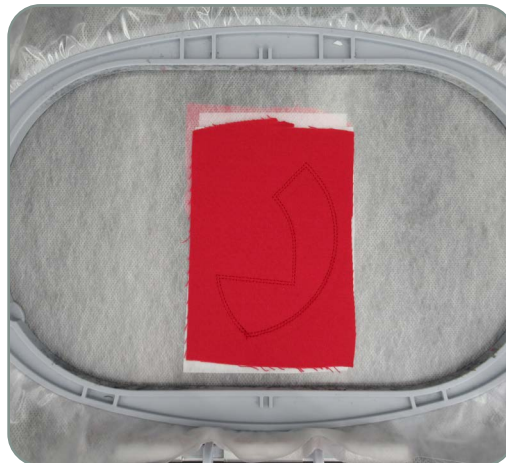

STEP 6

- Remove the hoop from the machine, DO NOT remove the design from the hoop.
- Trim next to the stitching of the front applique.
- Flip the hoop over and trim the excess fabric away from the back-applique.



CARDINAL BODY APPLIQUE

12835-14



STEP 7

- Return the hoop to the machine and stitch the remaining machine steps to complete the design.

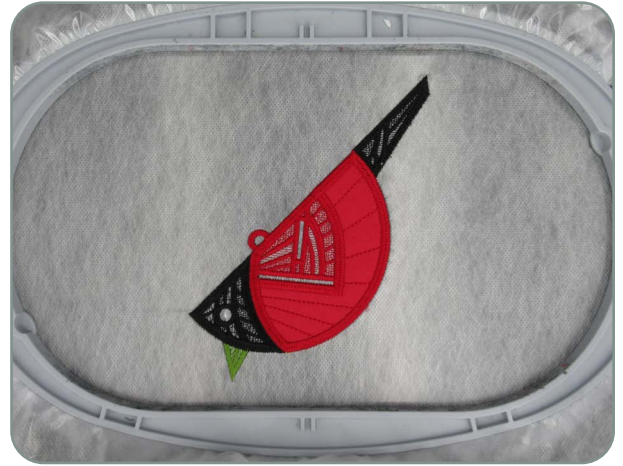

STEP 8

- Remove the design from the hoop and cut away the extra stabilizer ¼" from the design.
- Rinse away the remaining stabilizer in warm running water.
- Lay face down to dry.



CARDINAL WINGS AND BRACE

12835-14 & 12835-16



STEP 1

- Return the hoop to the machine and stitch the remaining machine steps to complete the design.

STEP 2

- Remove the design from the hoop and cut away the extra stabilizer ¼" from the design.
- Rinse away the remaining stabilizer in warm running water.
- Lay face down to dry.



STEP 3

- Once stitching is complete, remove the hoop and trim stabilizer about a ¼" from the lace.
- Rinse in warm running water. Rinse until just slightly sticky.
- Lay face down to dry.
- **Note:** These instructions also apply to 12835-09 through 12835-11, 12835-21, 12835-22, 12835-33.

CARDINAL ASSEMBLY

12835-14, 12835-15, & 12835-16



STEP 1

- FSA 12835-14 Cardinal Ornament Body
- FSL 12835-15 Cardinal Ornament Wings
- FSL 12835-16 Cardinal Ornament Wings Brace

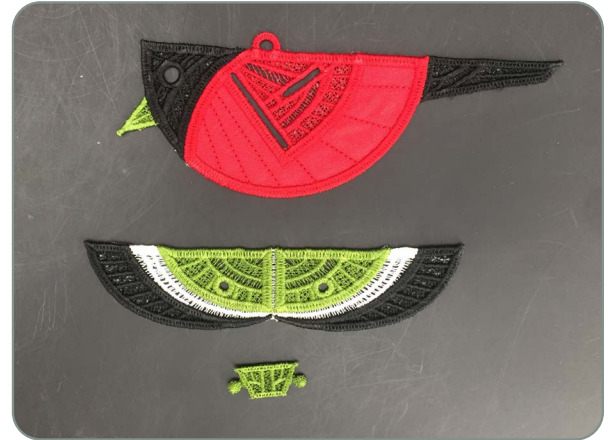

STEP 2

- Take the wing with the green straight edge facing up and slide it through the widest vertical slot on the cardinal body.

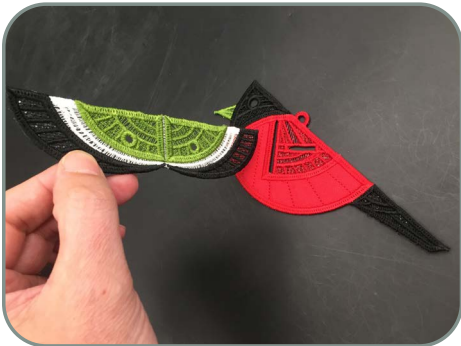

- Stop when the middle seam of the wing is aligned with the body.

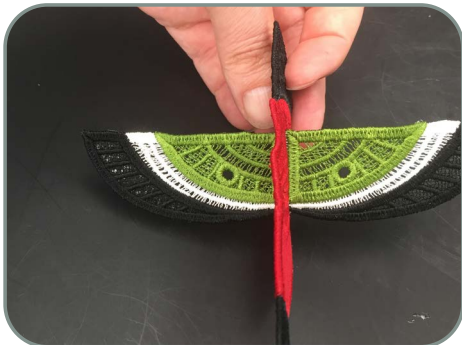
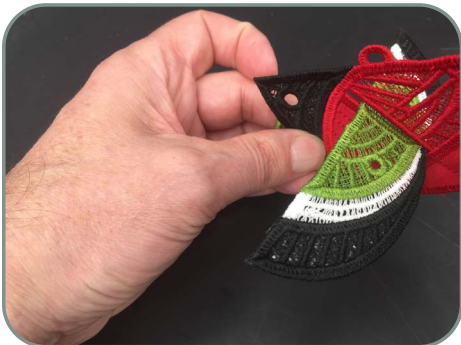

CARDINAL ASSEMBLY

12835-14, 12835-15, & 12385-16



STEP 3

- Slide in and center the wing brace in the smaller horizontal slot.
- Fold the wings back and attach the 2 buttonettes to the wing eyelets.

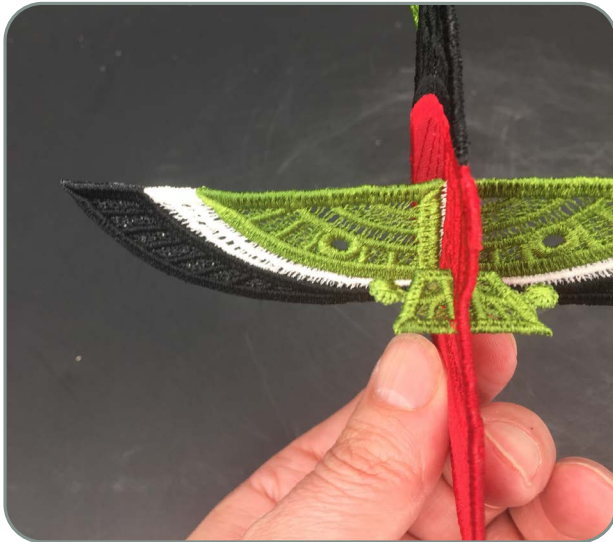

LIGHT BOX APPLIQUE

12835-23 THROUGH 12835-32



STEP 1

- **Note:** Match bobbin thread to top thread throughout.
- Cut one piece of applique fabric slightly larger than needed.
- Prep fabric by applying 2 pieces of StabilStick CutAway to the wrong side of the fabric.



STEP 2

- Hoop 1 layer of AquaMesh WashAway and 1 layer of BadgeMaster.
- Stitch Machine Step 1, the Placement Stitch.

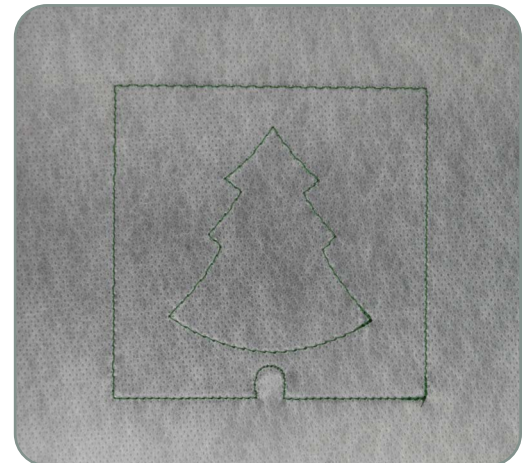

STEP 3

- Lightly spray temporary adhesive on the wrong side of fabric and place directly over the placement stitch face up, covering it entirely.

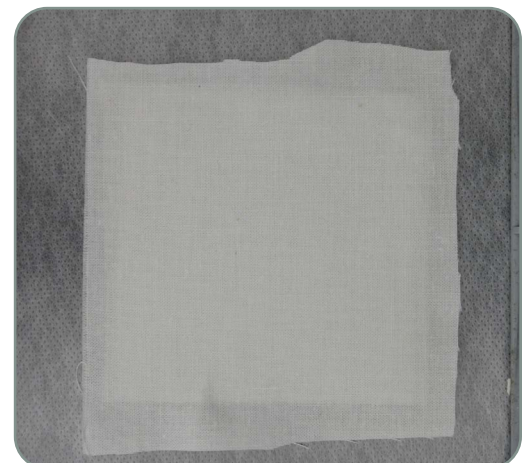

LIGHT BOX APPLIQUE

12835-23 THROUGH 12835-32



STEP 4

- Stitch Machine Step 2, Cut Line and Tackdown.

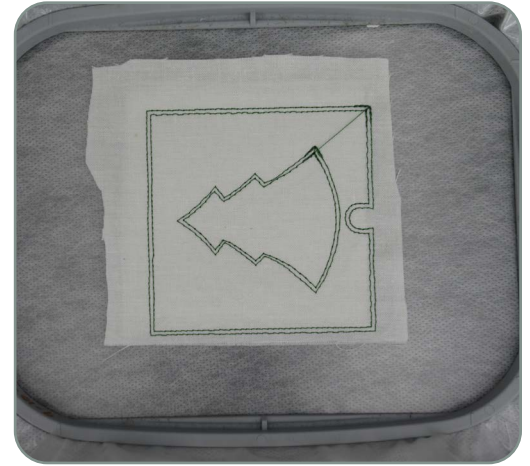

STEP 5

- Remove the hoop from the machine, but do NOT remove project from the hoop.
- Trim the fabric along the cut line on the inner and outer edges of the design.



STEP 6

- Stitch the remainder of the design.
- When complete, remove the design from the hoop and trim stabilizer to about 1/4" around the design.
- Wash away the remaining stabilizer in warm running water.
- Lay flat face down to dry.



LIGHT BOX ASSEMBLY

12835-23 THROUGH 12835-31



- Designs 12835-23 through 12835-29 are the side pieces for the light box.
- Design 12835-30 is the top, 12835-31 is the Base.



STEP 1

- Choose the side pieces and top for the lightbox.
- Using either a zigzag or serpentine stitch, sew the top of the side piece to the top piece. Do this for all 4 pieces.



STEP 2

- Pull the buttonettes through the eyelets of the side pieces. Next pull the buttonette on the base through the corresponding eyelets in the sides.



LIGHT BOX BOW TOP

12835-32 & 12835-33



- Designs 12835-32 & 12835-33 are an alternative freestanding lace bow assembly for the top of the light box



STEP 1

- Choose the side pieces and top for the lightbox.
- Using either a zigzag or serpentine stitch, sew the top of the side piece to the top piece. Do this for all 4 pieces.



STEP 2

- Attach the 2 buttonettes in the middle of the bow by pulling through the eyelets in the middle of the top piece.

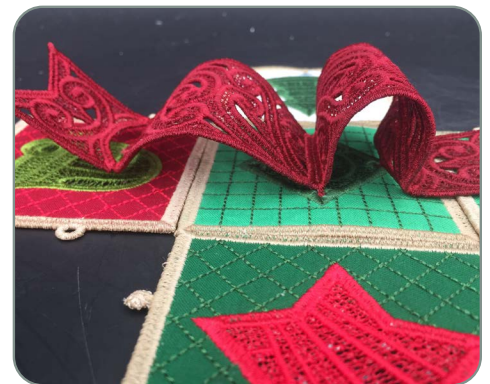
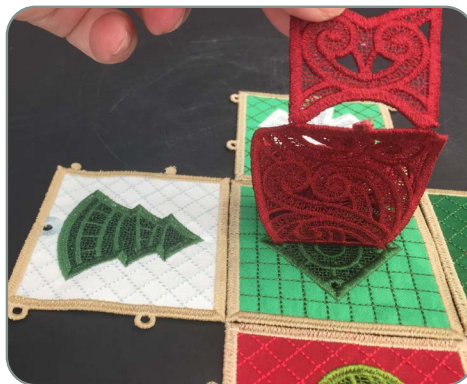

- **Tip:** Shape the bow into a rounded shape before attaching.
- Continue attaching the remaining buttonettes as described above.

TREE APPLIQUE

12835-34 THROUGH 12835-51



STEP 1

- **Note:** Match bobbin thread to top thread throughout.
- Cut 2 pieces of fabric slightly larger than needed for applique.
- Prep 2 pieces of applique fabric by adhering one layer of StabilStick CutAway to the wrong side of each piece.

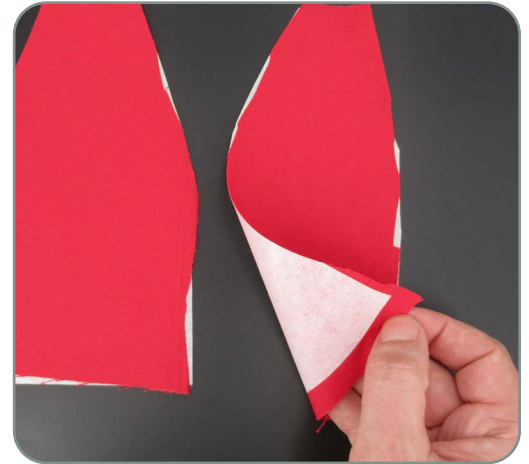

STEP 2

- Hoop one piece of AquaMesh WashAway and one piece of BadgeMaster.
- Stitch Machine Step 1, Front and Back Red Fabric Placement Stitch.

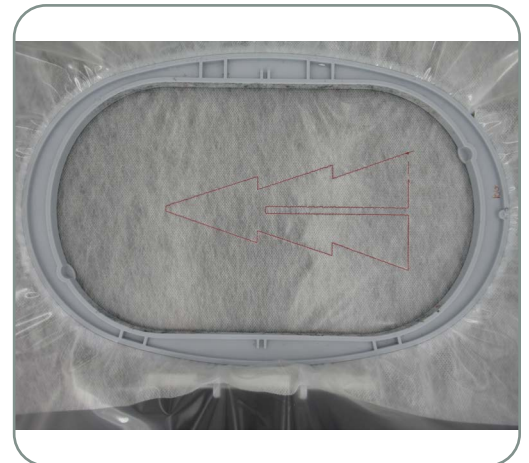

STEP 3

- Remove the hoop from the machine, do NOT remove the project from the hoop.
- Using temporary spray adhesive, spray the wrong side of the applique piece and place directly over the placement stitch, covering it entirely.
- **Note:** Alternatively, Expert Embroidery Tape TearAway may be used in place of spray.

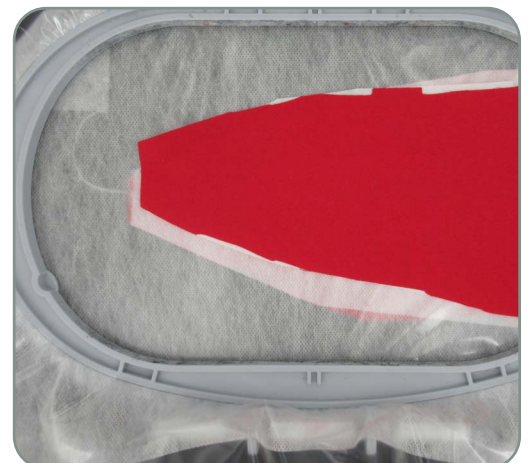

TREE APPLIQUE

12835-34 THROUGH 12835-51



STEP 4

- Flip the hoop over and repeat Step 3 for the back-applique piece.
- Return the hoop to the machine.



STEP 5

- Stitch Machine Step 2, Cut Line and Tackdown.

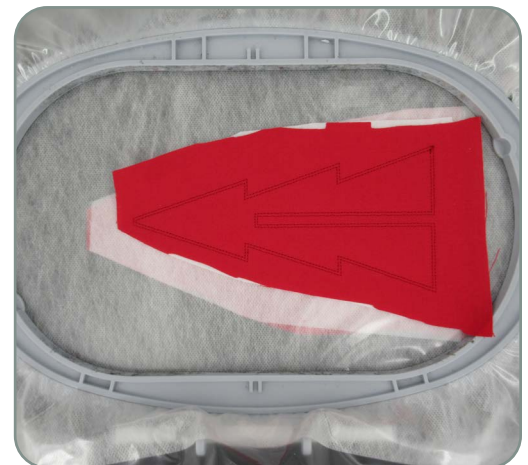

STEP 6

- Remove the hoop from the machine, DO NOT remove the design from the hoop. Trim close to the cut line of the front applique.
- Flip the hoop over and repeat for the back applique.



TREE APPLIQUE

12835-34 THROUGH 12835-51



STEP 7

- Return the hoop to the machine and stitch the remaining machine steps to complete the design.

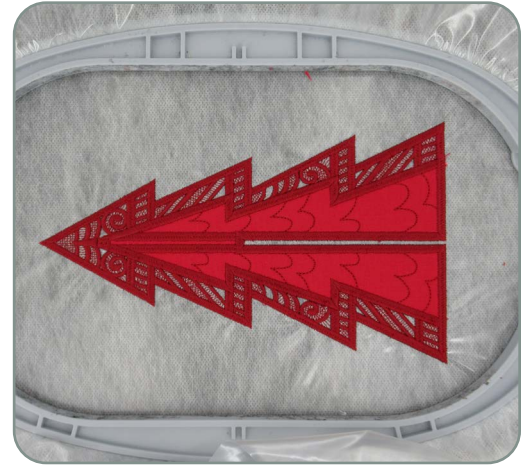

STEP 8

- Remove the design from the hoop and cut away the extra stabilizer ¼" from the design.
- Rinse away the remaining stabilizer in warm running water, and lay face down to dry.



TREE ASSEMBLY

12835-34 THROUGH 12835-51



STEP 1

- Choose the Tree size and style.

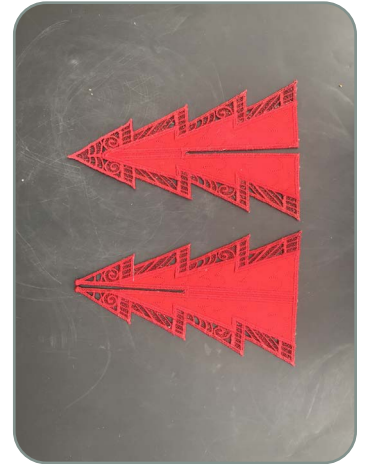

STEP 2

- The tree half with the open end on the upper half is the bottom.
The tree half with the open end on the lower half is the top of the tree.

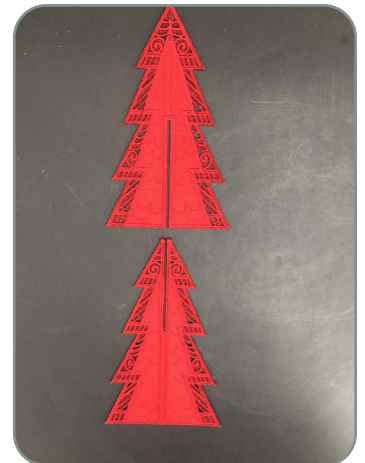

STEP 3

- Slide the top of the tree into the open end of the lower part of the tree.

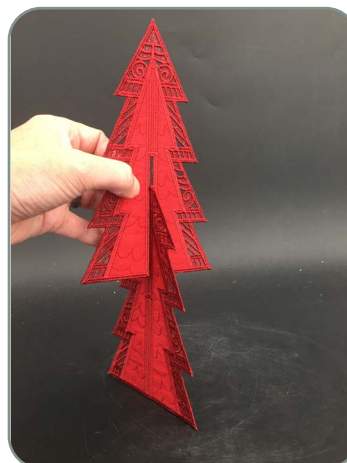

Pre-Cut Applique Instructions

1. Print out the necessary pages from the PDF of the applique pattern(s).
2. Mark the right side of the pattern pieces so you'll know which direction to lay the pattern on the fabric.
3. Lightly spray the wrong side of the pattern pieces with temporary adhesive spray and allow it to set for a few minutes.
4. Place the pattern pieces on the right side of the fabric and carefully cut them out. **PHOTO 1**
5. Sew the placement stitch on your hooped fabric. **PHOTO 2**
6. With the paper still stuck to the right side of the applique fabric, spray the wrong side of the fabric with temporary spray adhesive.
7. Place the fabric inside the placement stitch, so that it completely covers the placement stitch and then remove the paper pattern. **PHOTO 3**
8. Sew the tackdown. **PHOTO 4**
9. Sew the remainder of the design and repeat for any remaining pieces. **PHOTO 5**

NOTE: The patterns are sized for the designs as they were made. If you resize the design, you will need to resize the pattern the same amount. You can print out the pattern at the normal size then copy it on a copy machine at the changed size. For example, resize the designs to 80%, resize the printed pattern to 80%.

TIP: When Printing the patterns, make sure that the “Fit to page” option is **UNCHECKED** in the Print Dialog Box. If this option is checked the printed patterns will not be actual size.

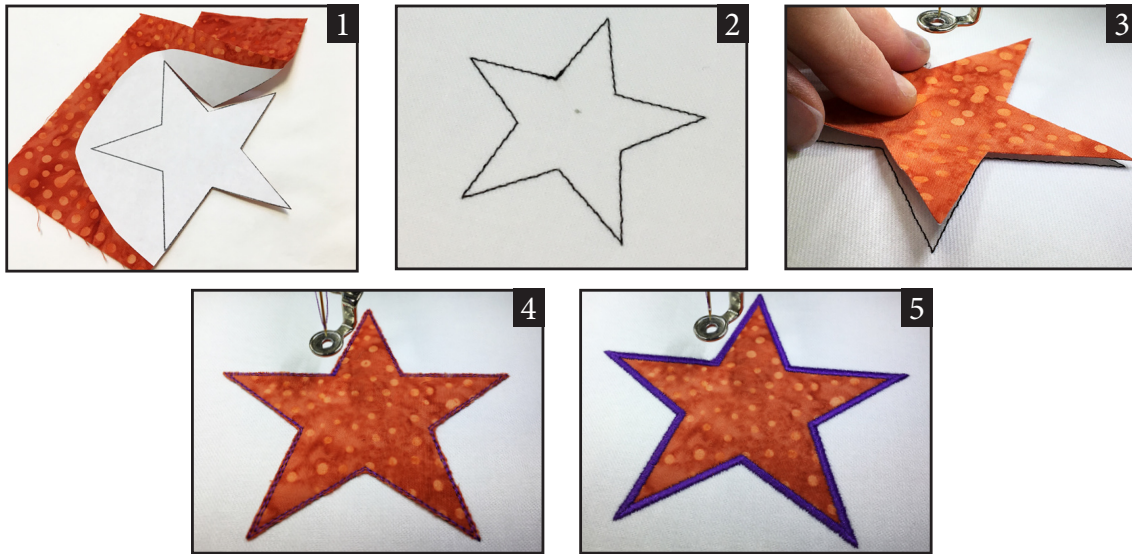

General Freestanding Lace Guidelines

Supplies:

Embroidery Thread:

- Use the same embroidery thread in the bobbin as the needle.

Needles:

- Use an Organ 80/12 Titanium needle for extended needle life.

Stabilizer:

- Use OESD AquaMesh stabilizer.

Handy Hints:

For Stiffer Lace:

- DO NOT rinse away all of the stabilizer for a “stiffer” lace. Note that the thread may appear a shade darker if stabilizer is not removed completely.
- If you happen to wash too much out, easily re-stiffen by diluting some stabilizer scraps in water and dipping the item in the solution.

For Very Soft Lace:

- Cut away excess stabilizer. Remove remaining stabilizer by rinsing under warm running water until all traces of the stabilizer are gone. **NOTE:** If lace should become too limp to work with, dissolve stabilizer scraps in warm water and apply to the lace.

Drying Lace:

- The lace looks best when left to dry completely. Lay lace piece with right side down to dry. This will minimize the tendency for the lace to curl. Be sure to flatten the piece out entirely and allow ample time to dry.

General Instructions

1. Hoop two layers of OESD AquaMesh Stabilizer.
2. Attach the hoop to the machine and select the design of your choice.
3. Stitch the design.
4. Remove the hoop from the machine and the design from the hoop. Trim excess stabilizer from the design.
5. Rinse away remaining stabilizer and allow it to dry.

APPLIQUE PATTERNS

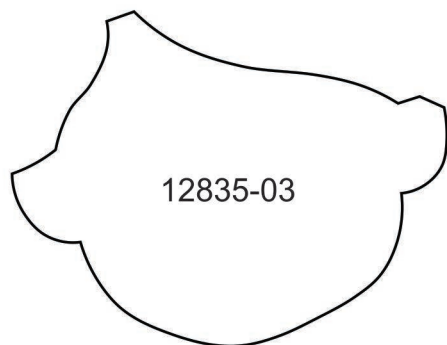
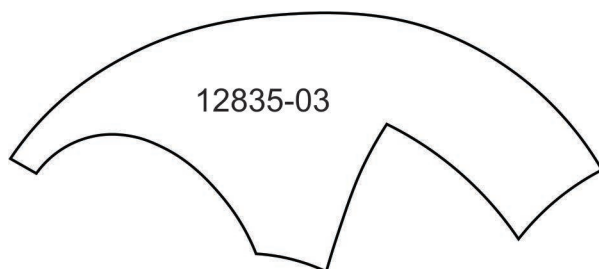
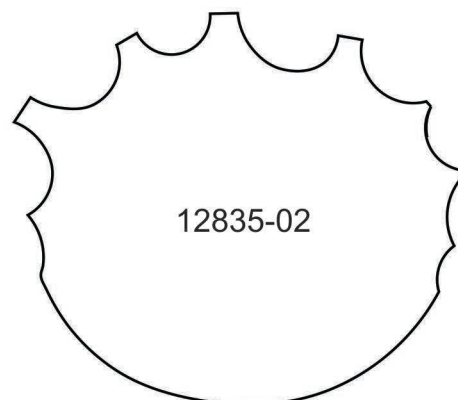
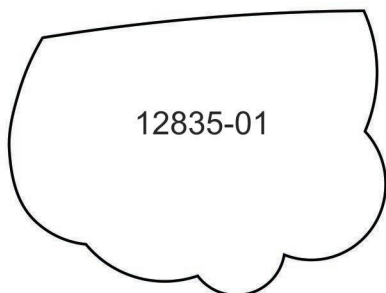
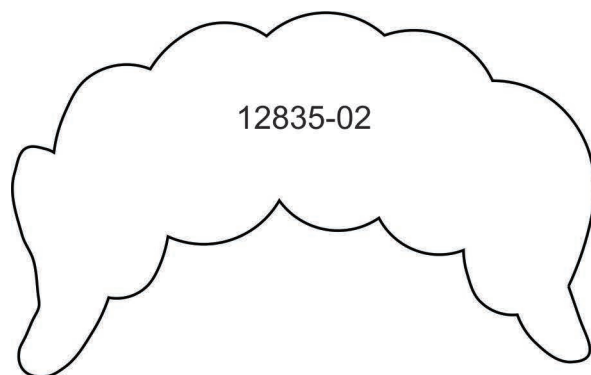
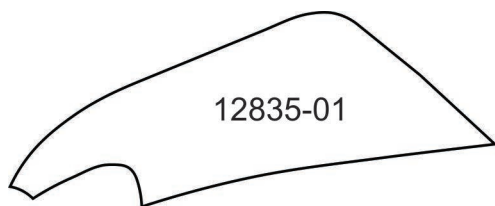

APPLIQUE PATTERNS

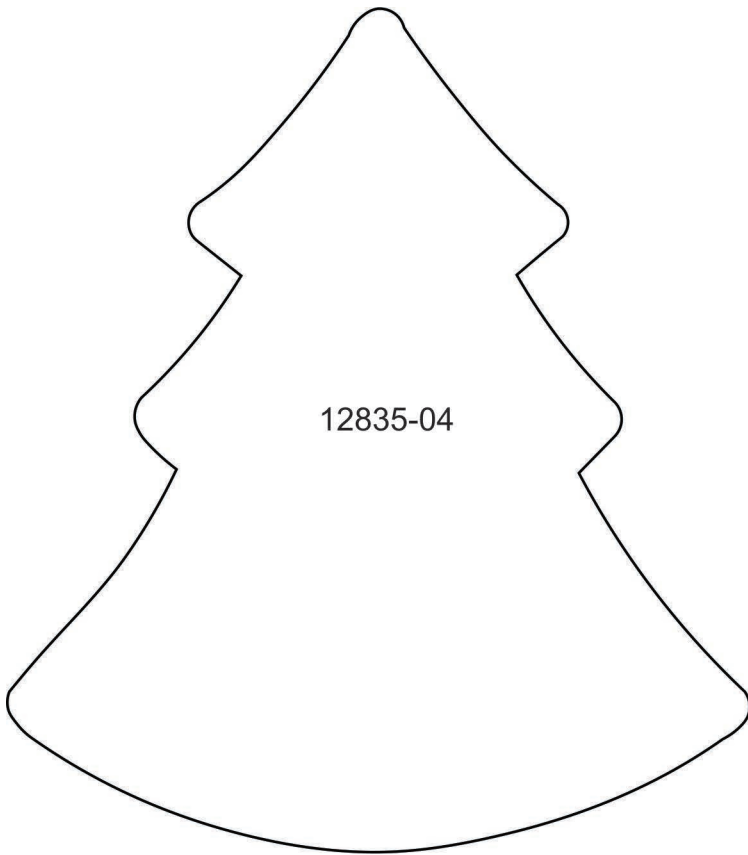

12835-04

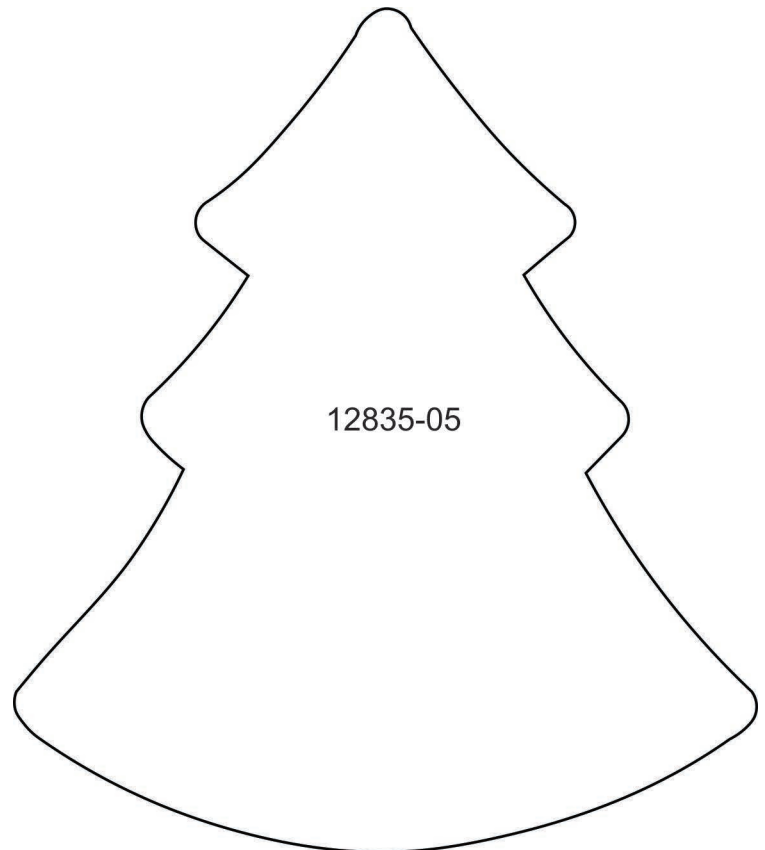

12835-05

APPLIQUE PATTERNS

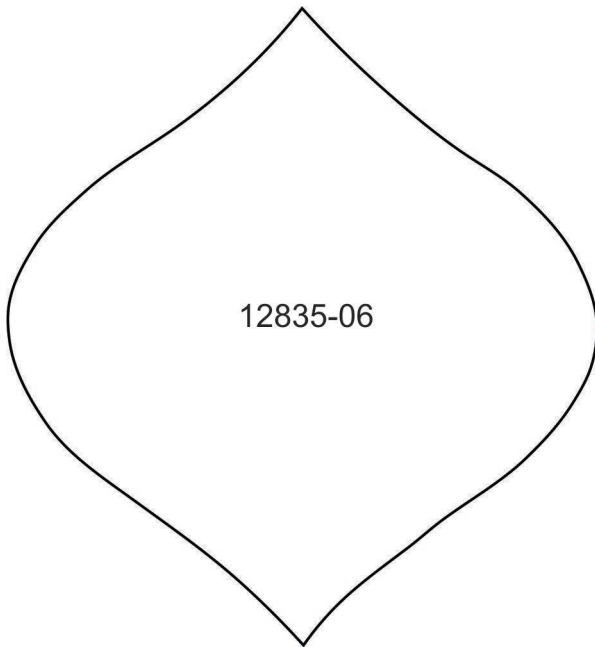

12835-06

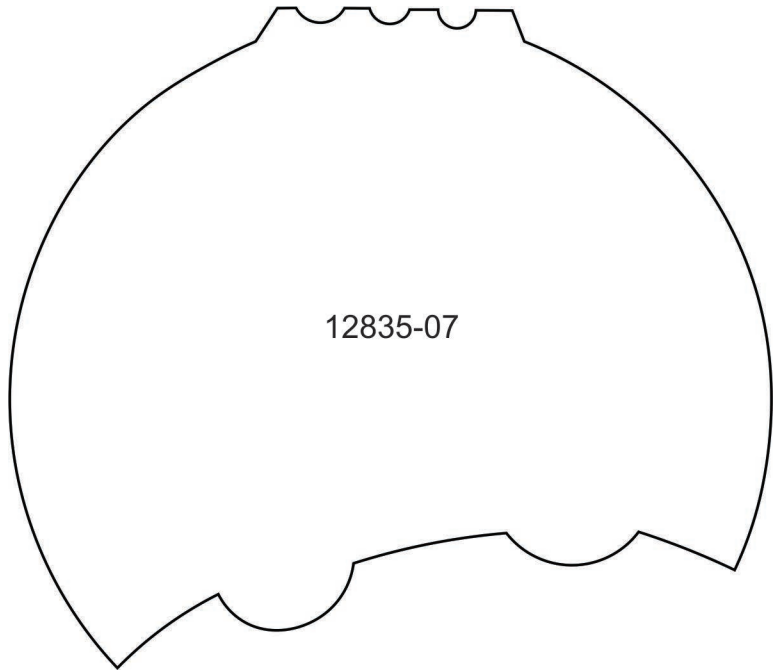

12835-07

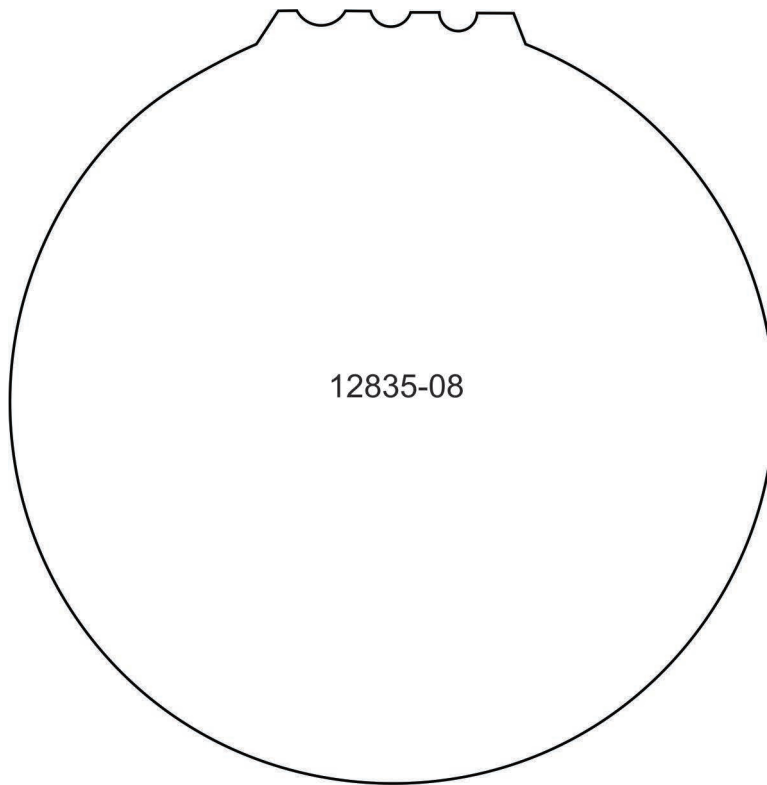

12835-08

APPLIQUE PATTERNS

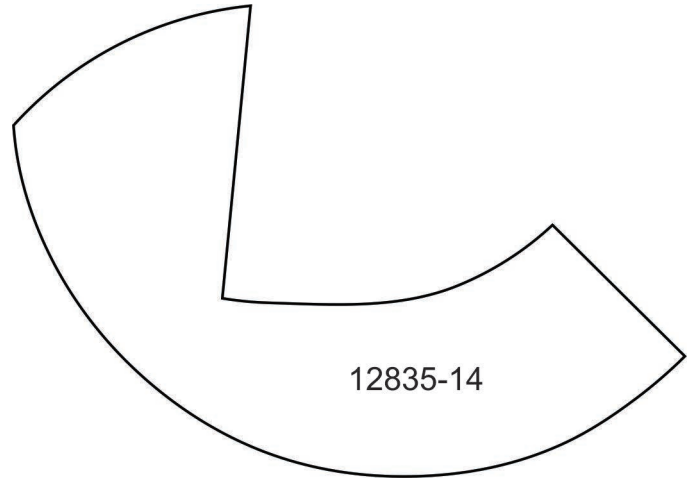
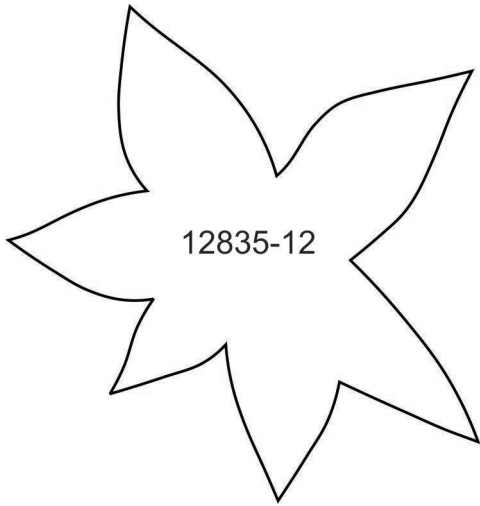

APPLIQUE PATTERNS

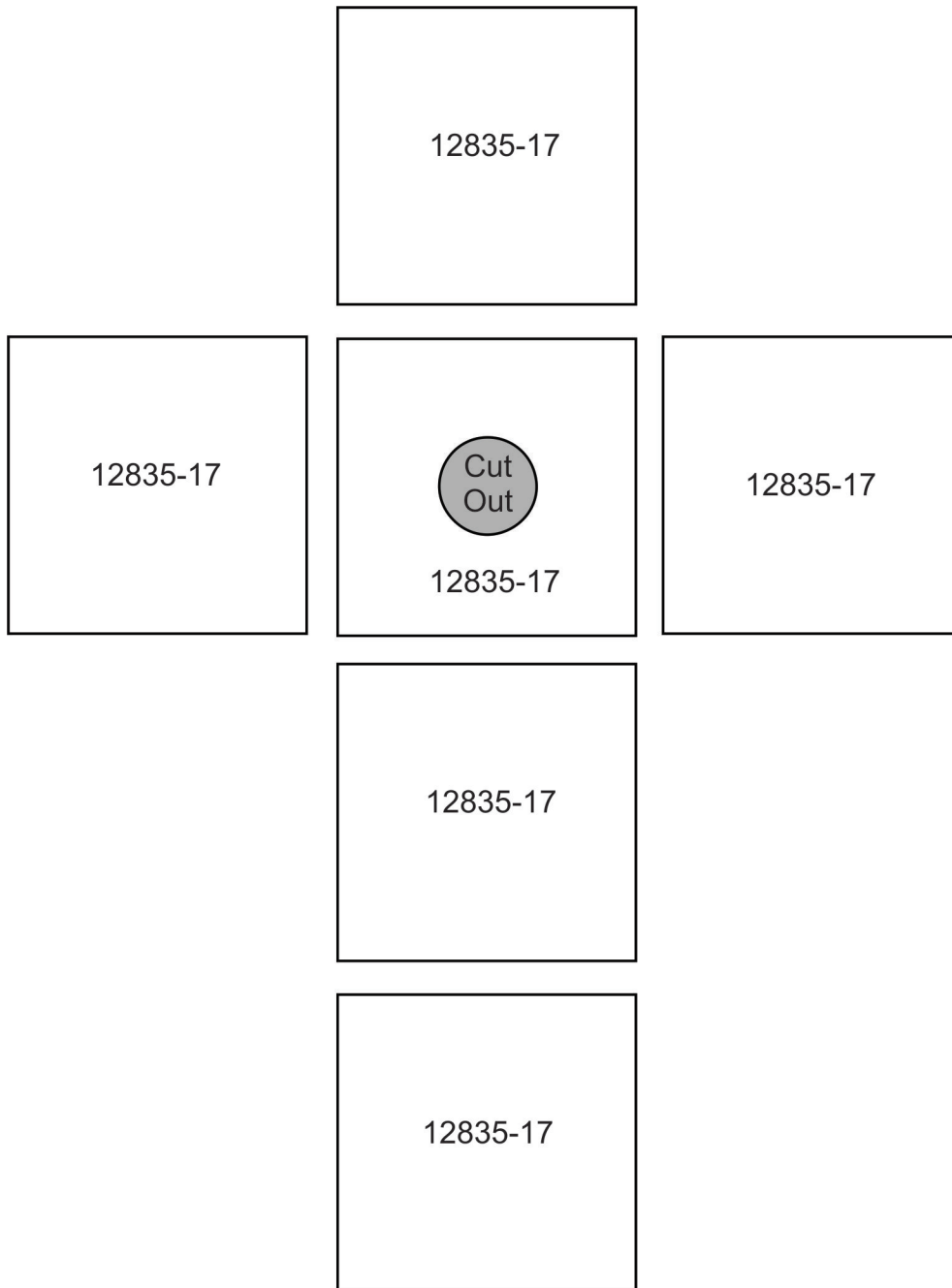

APPLIQUE PATTERNS

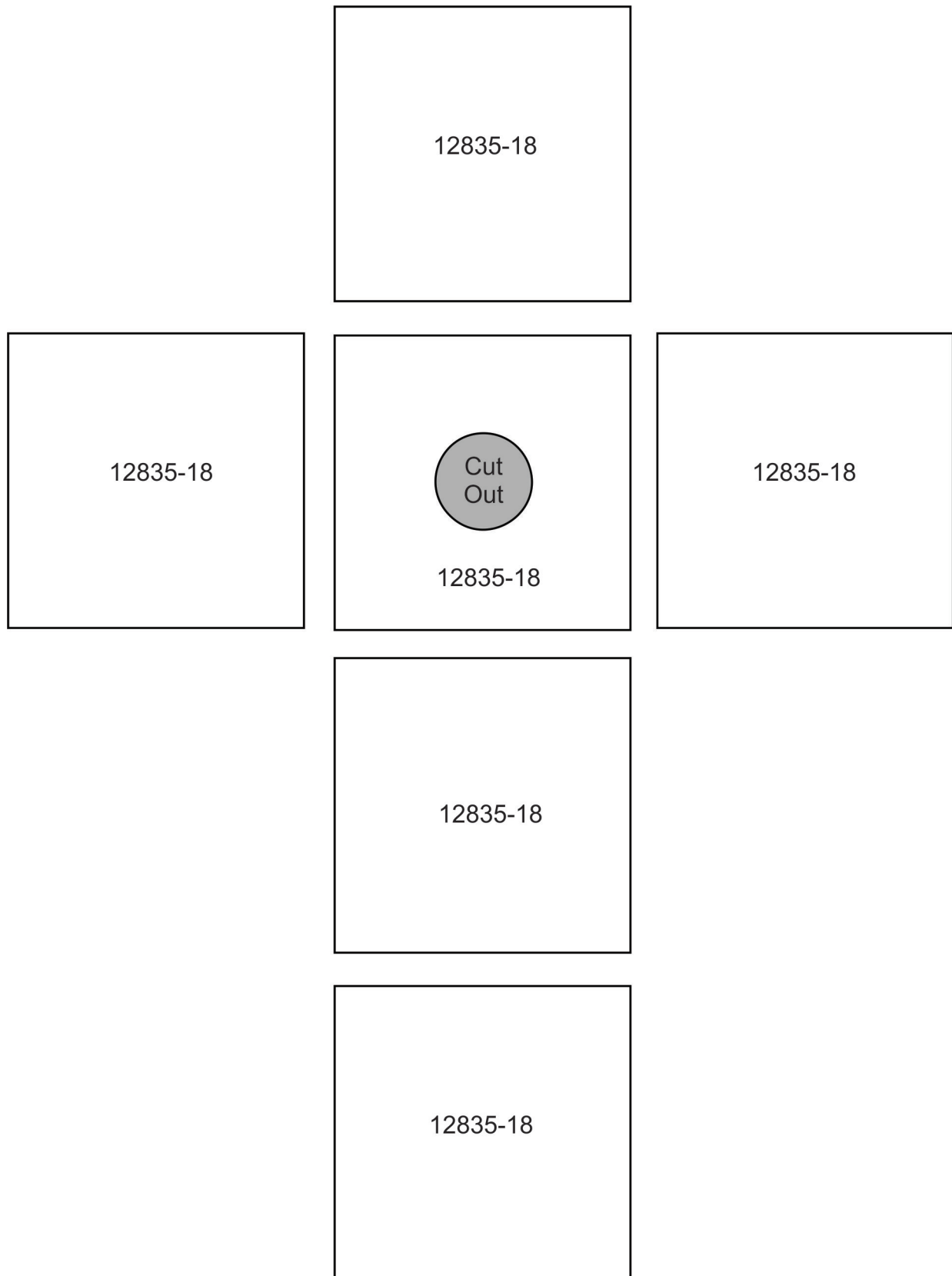

APPLIQUE PATTERNS

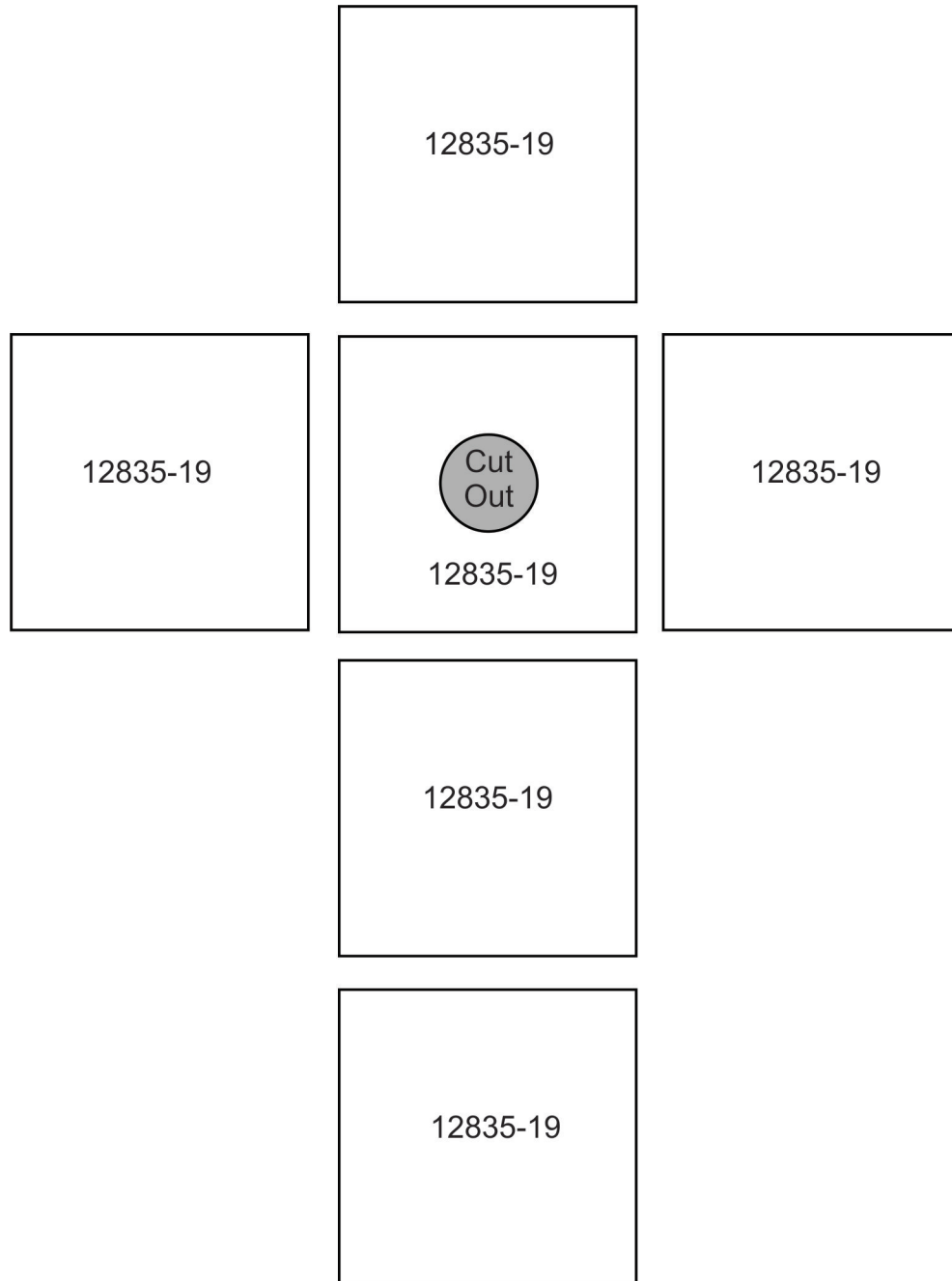

APPLIQUE PATTERNS

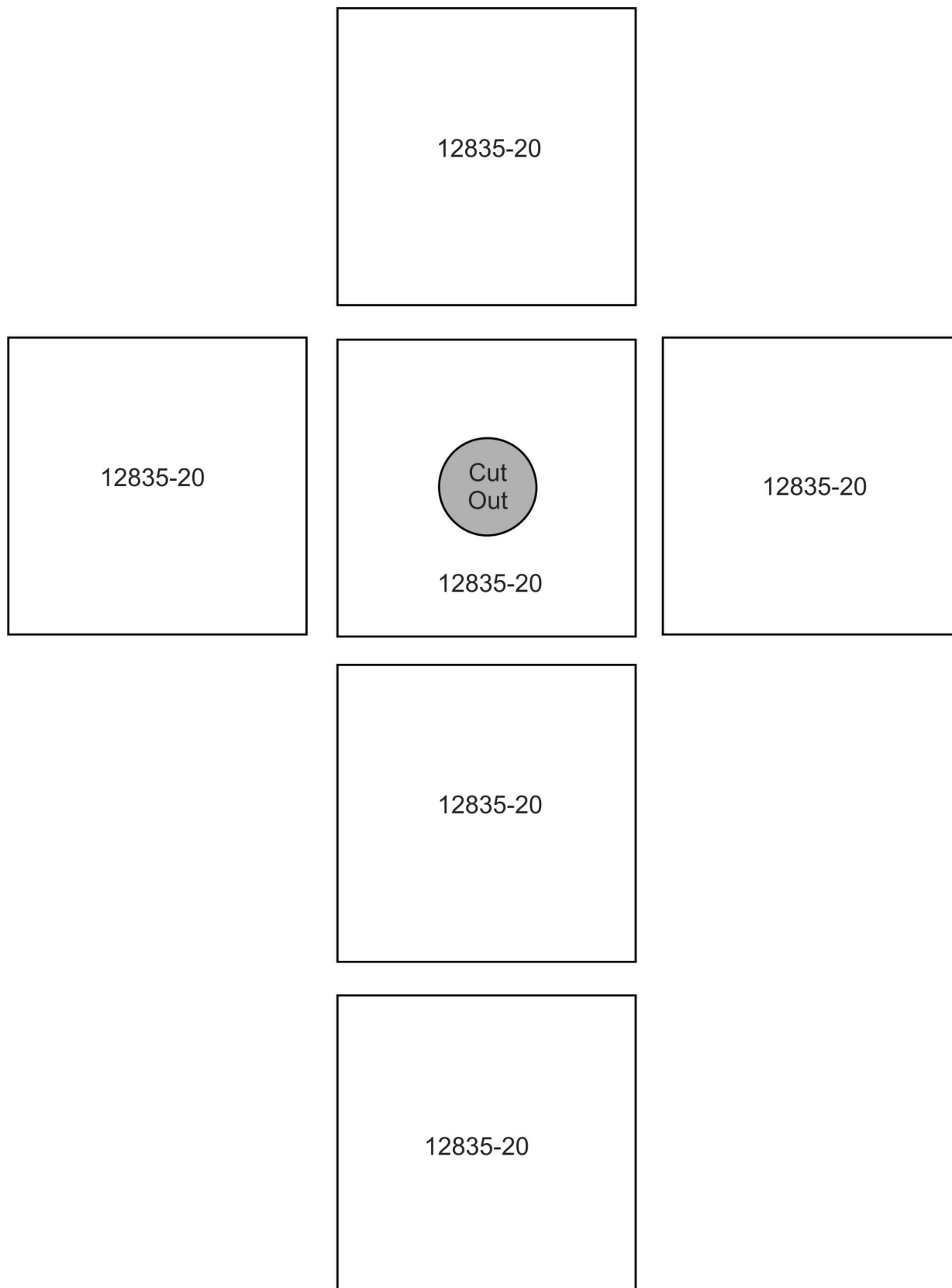

APPLIQUE PATTERNS

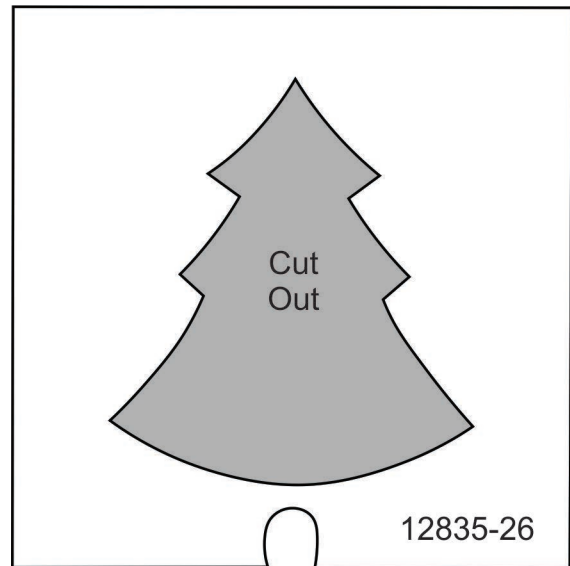
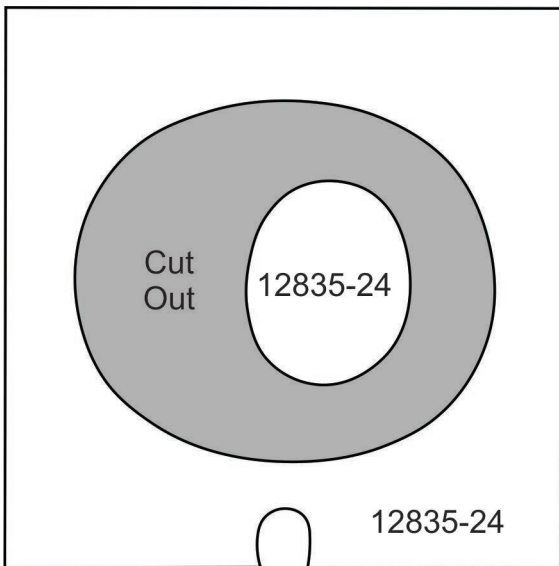
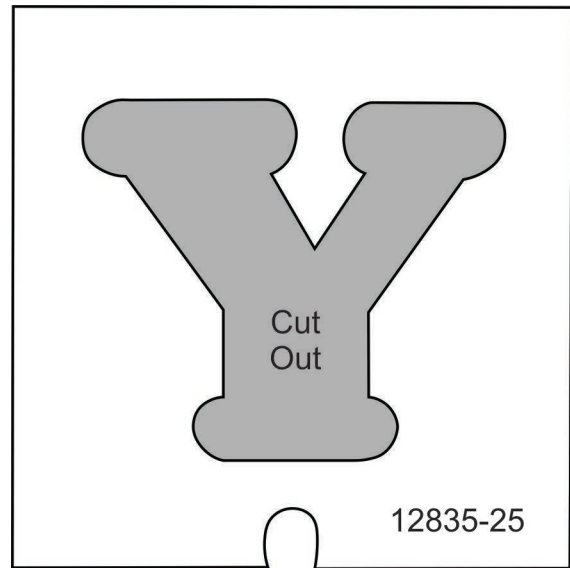
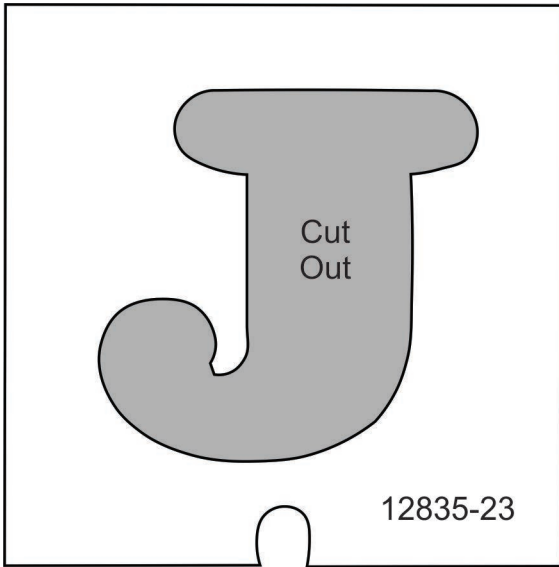

APPLIQUE PATTERNS

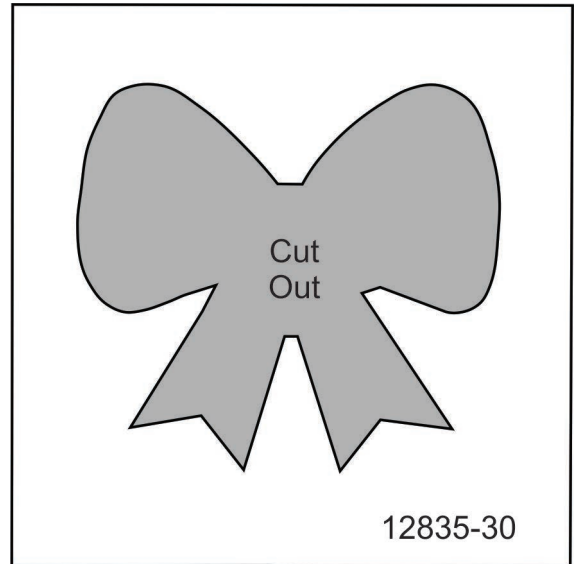
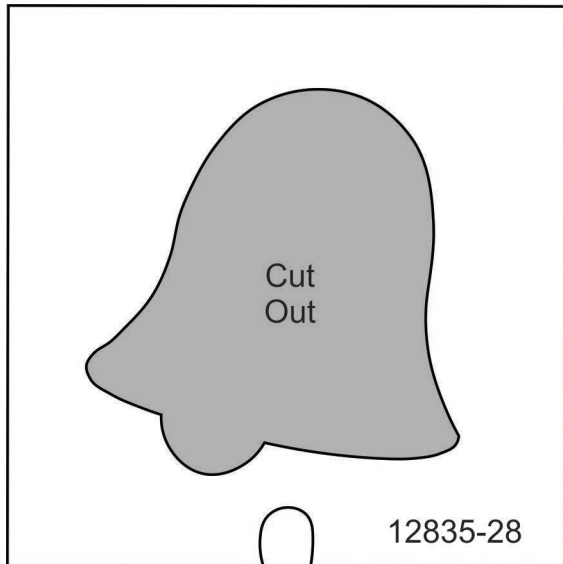
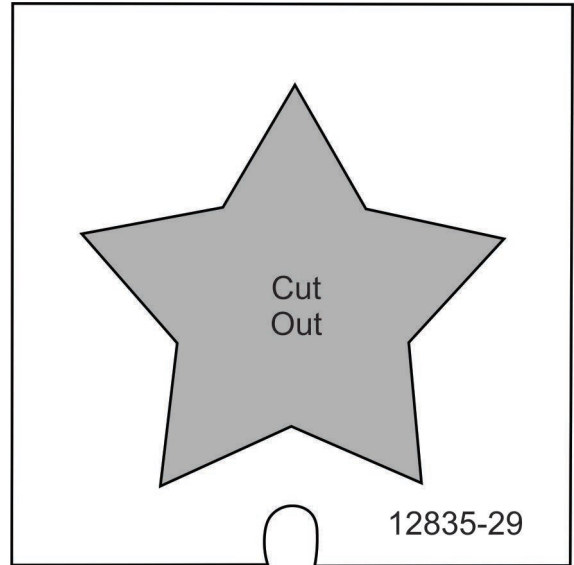
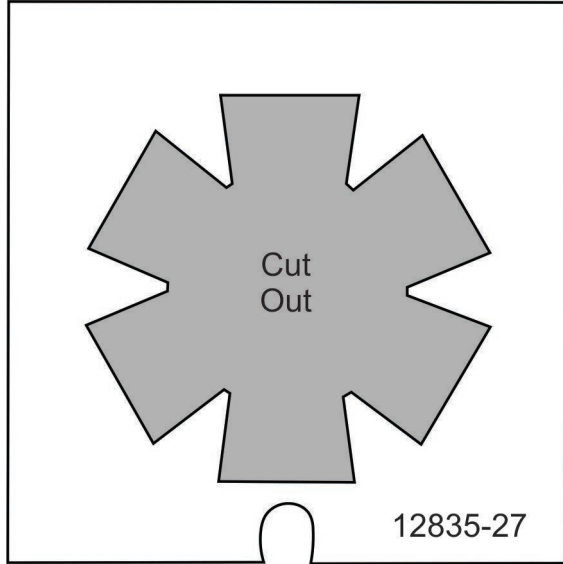

APPLIQUE PATTERNS

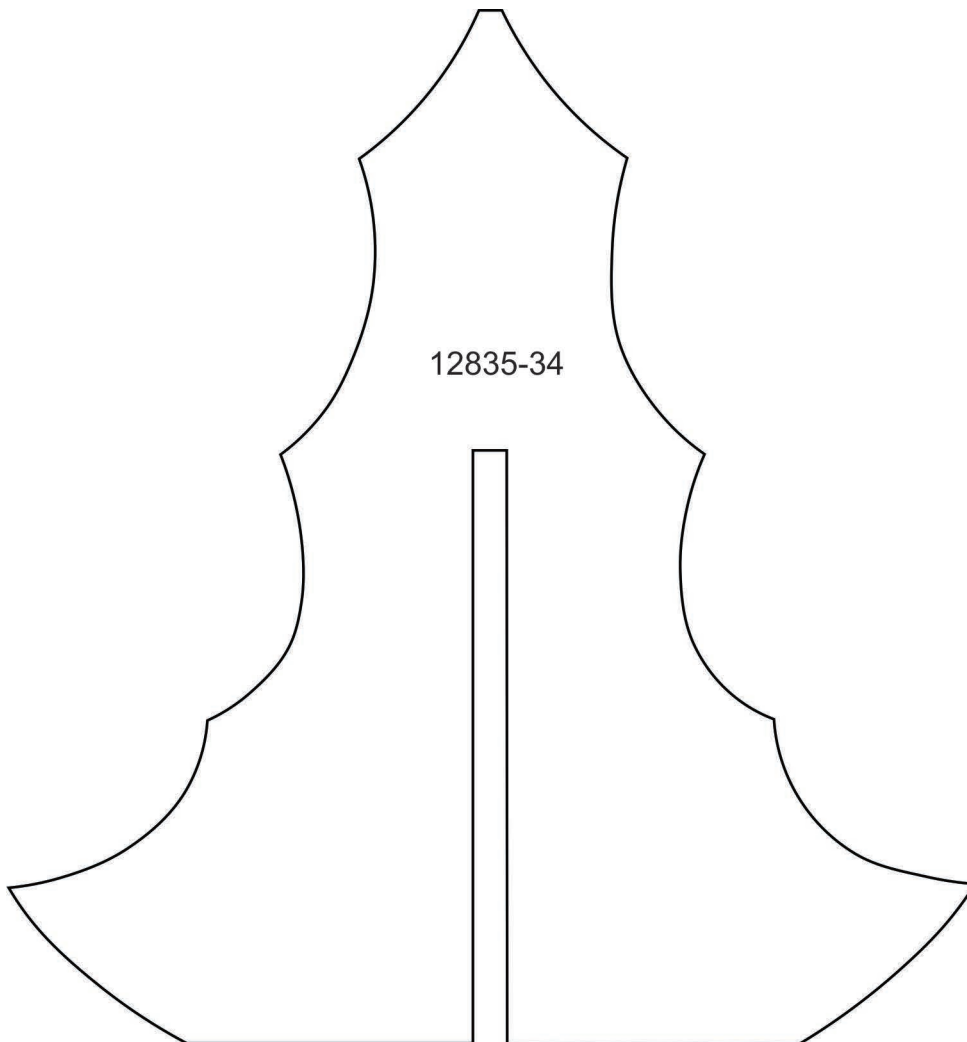
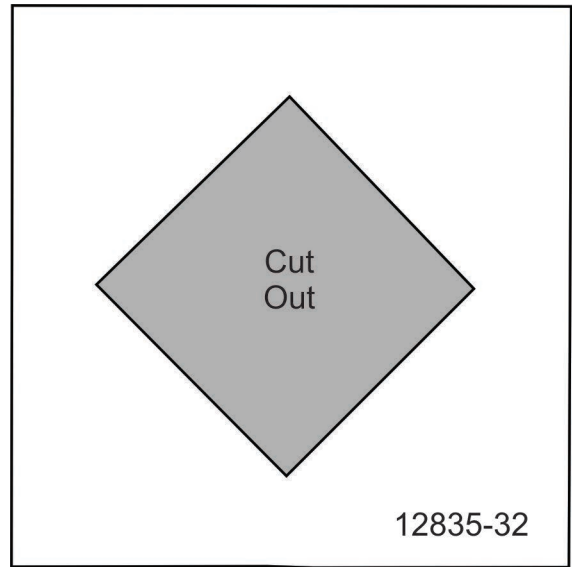
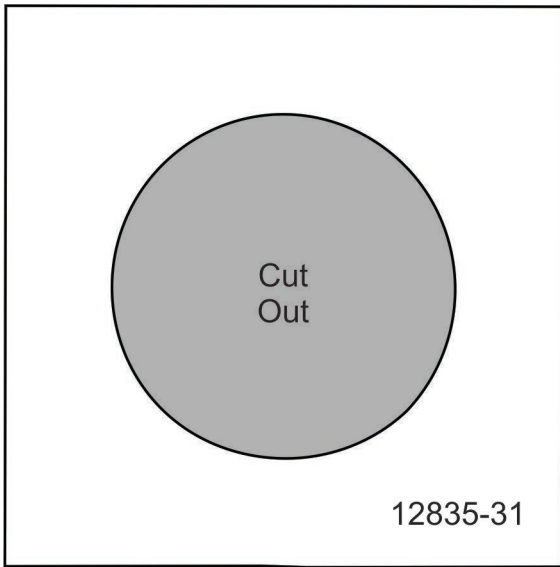

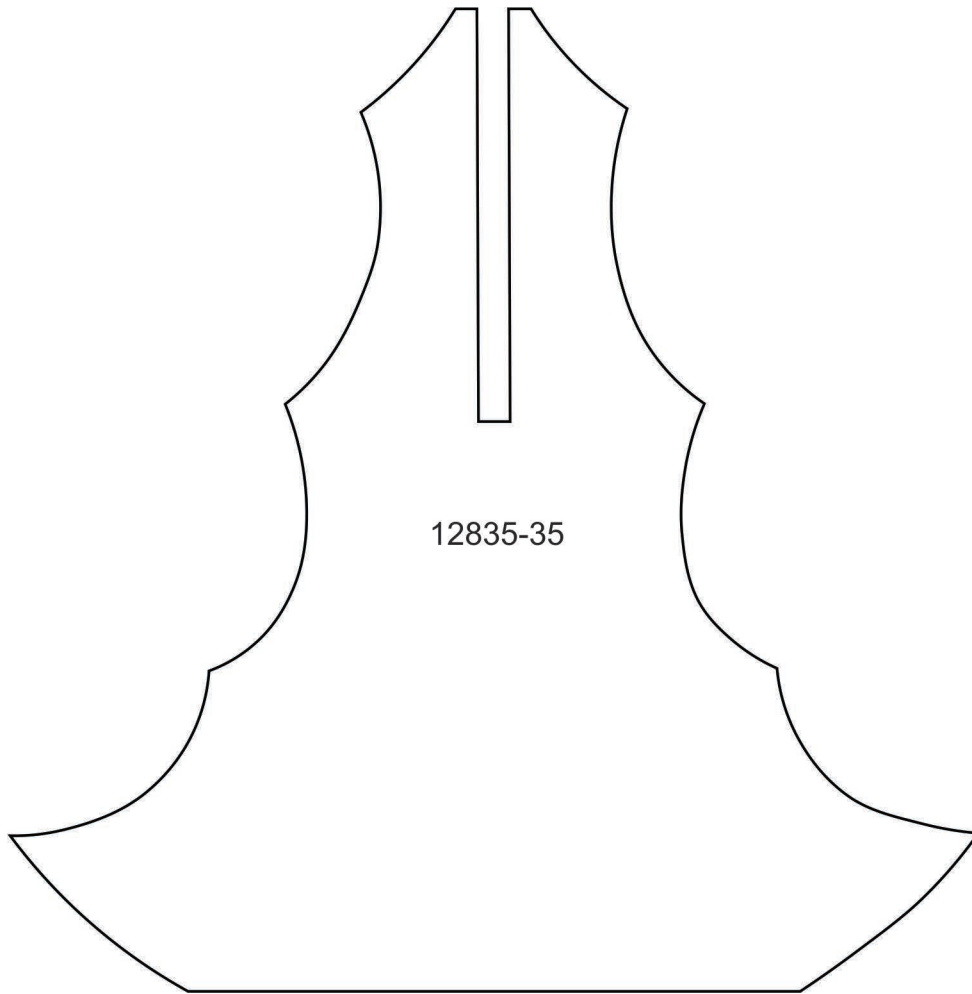

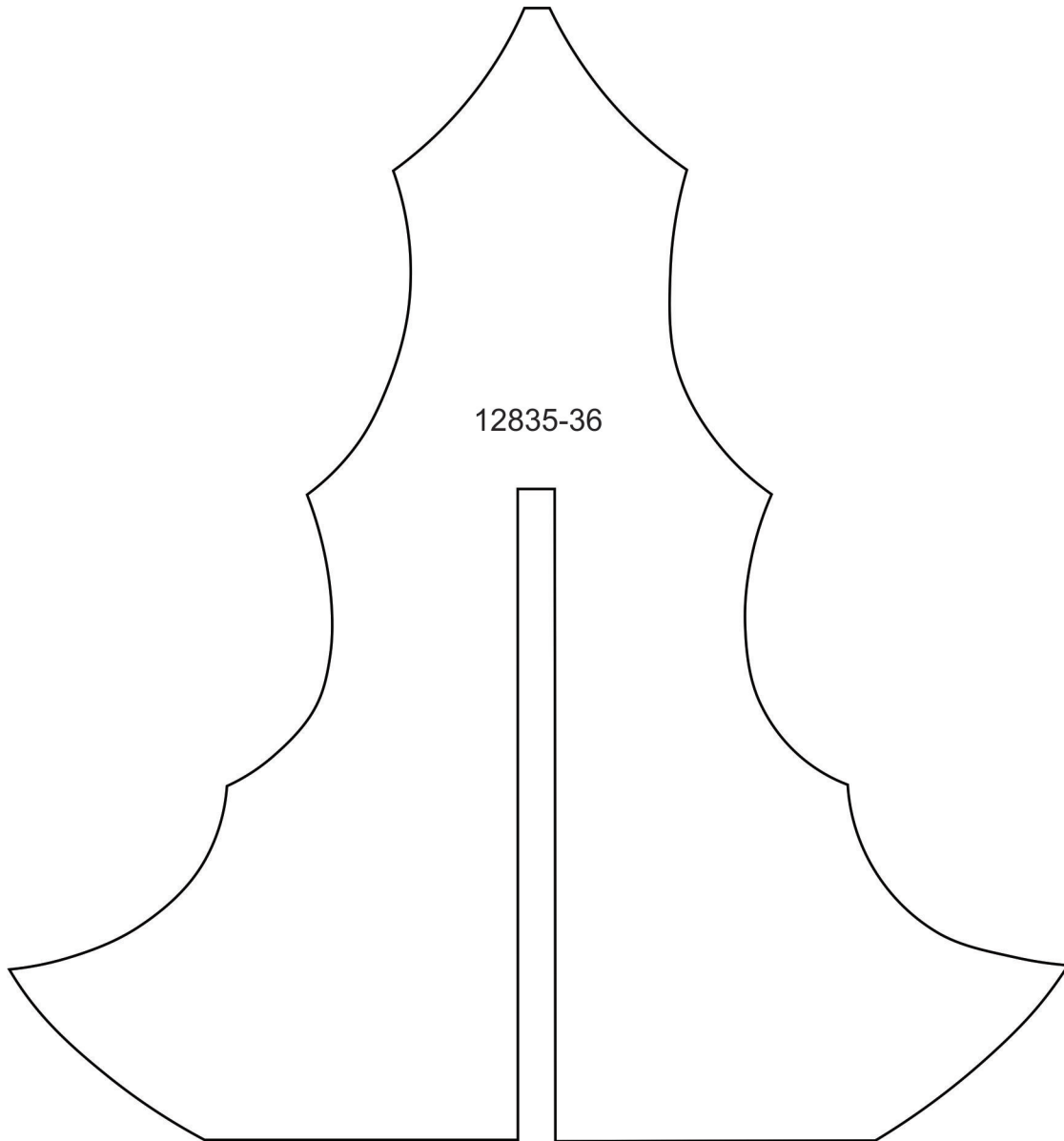

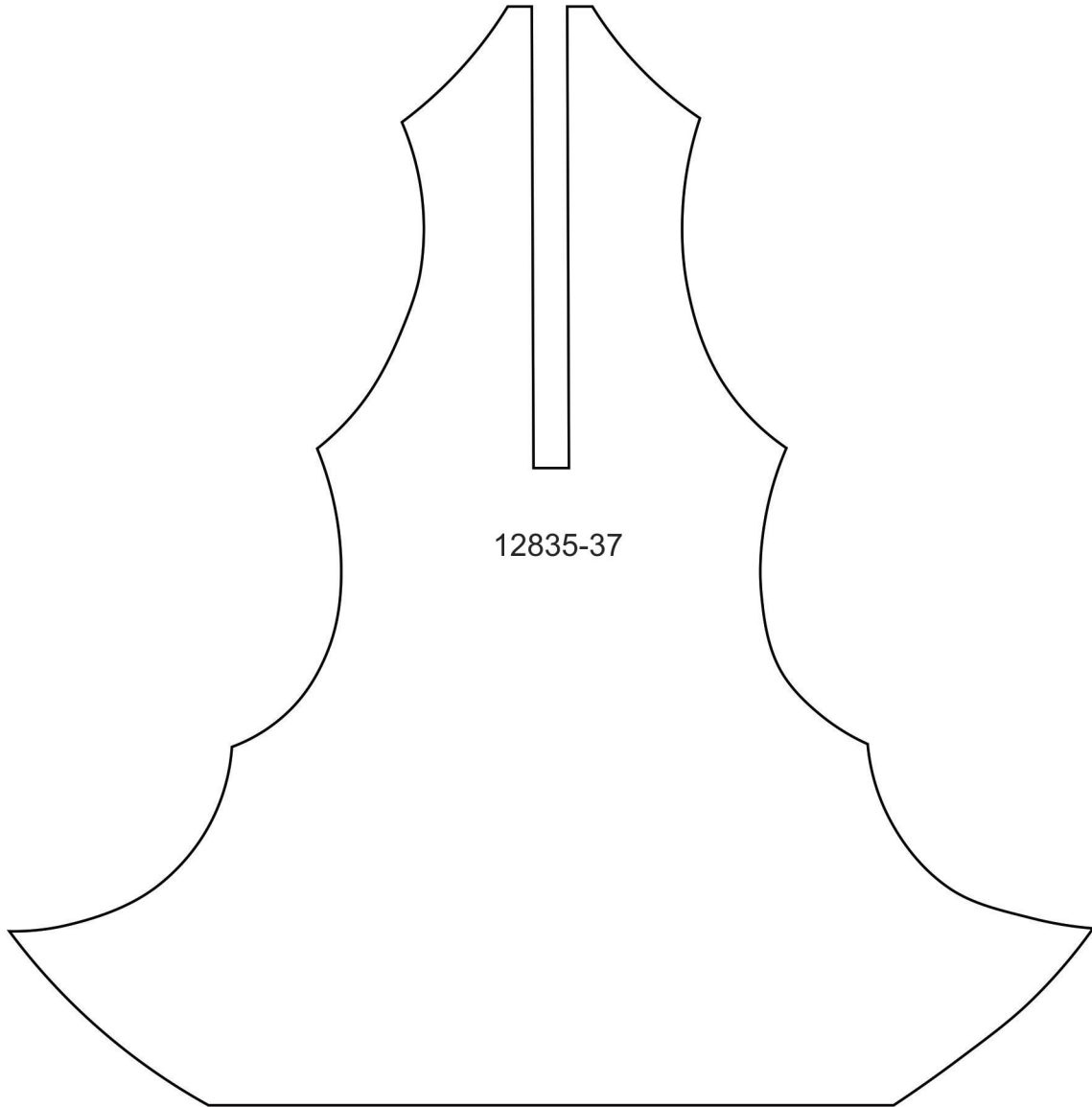

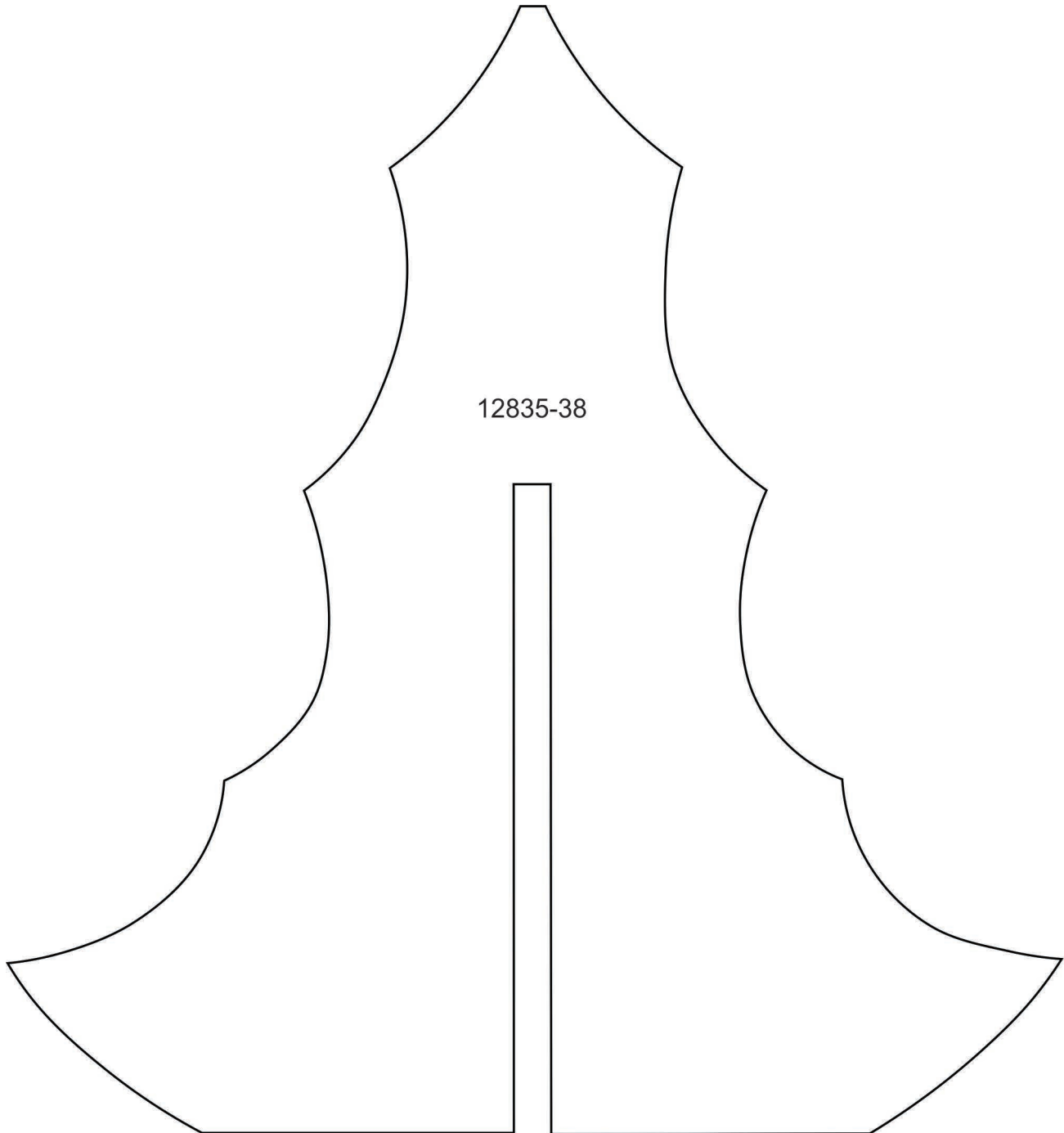

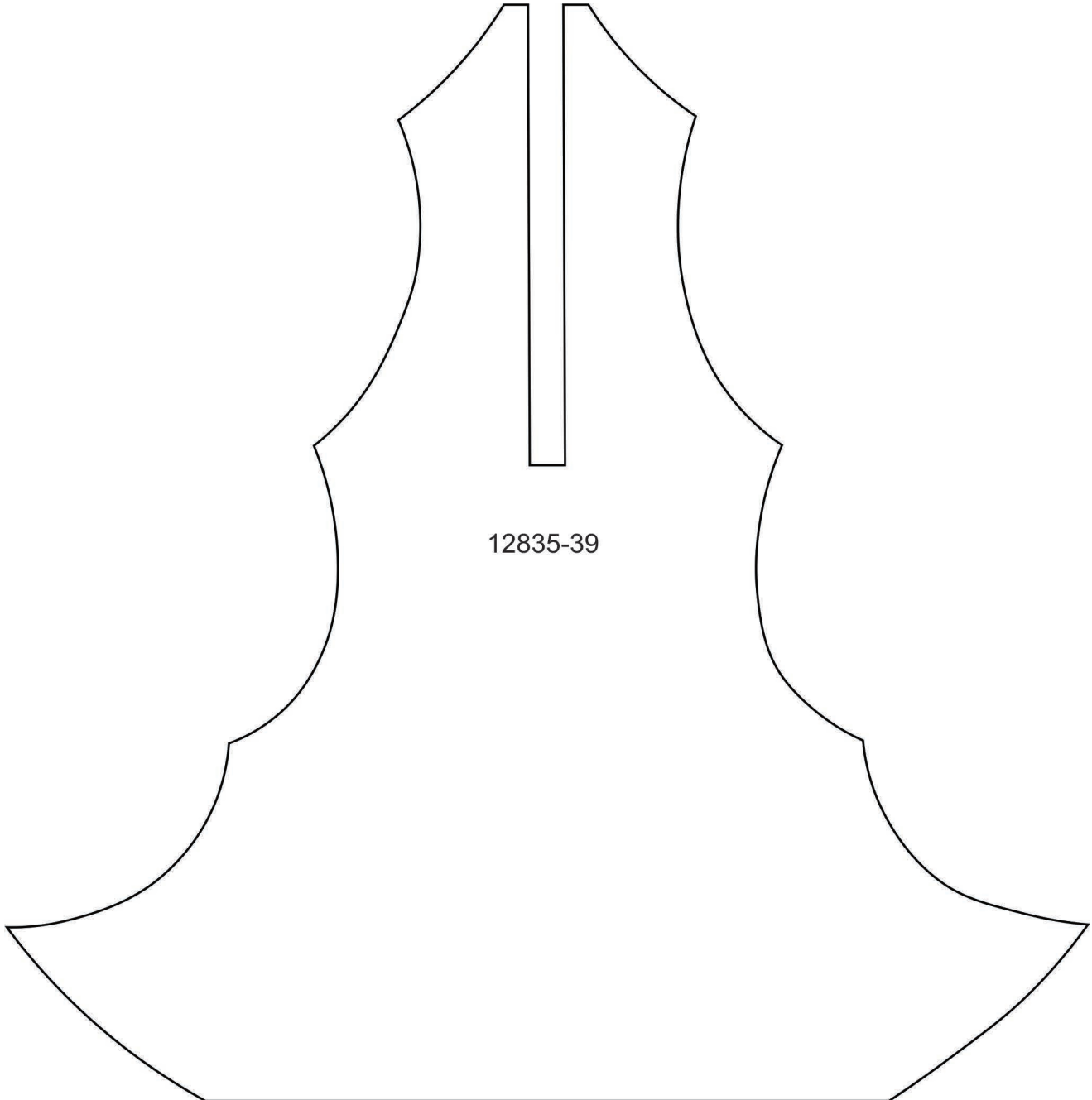

APPLIQUE PATTERNS

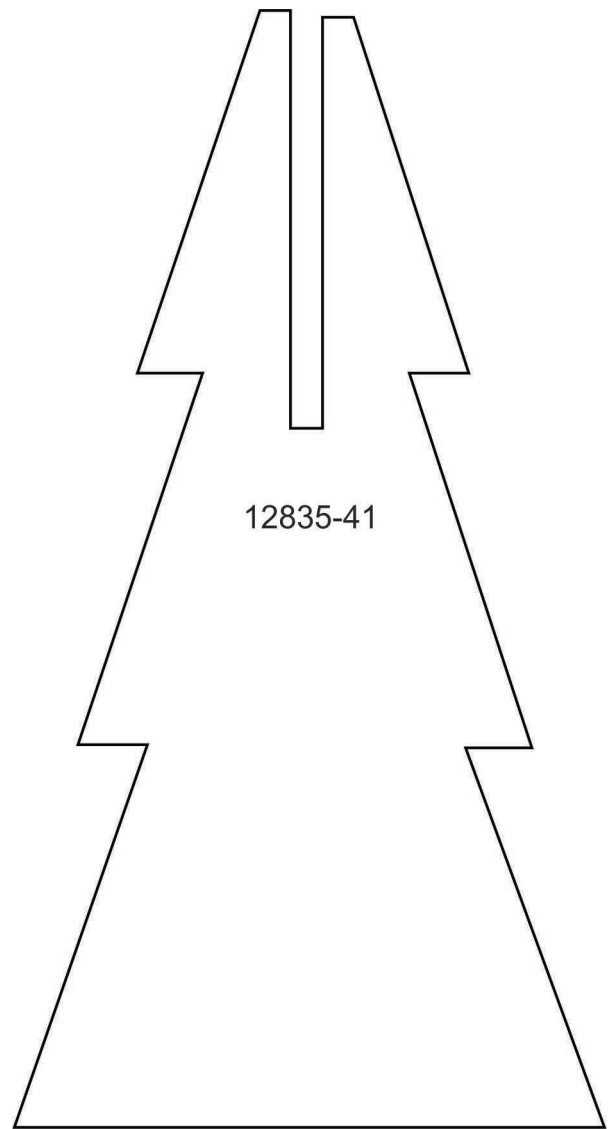
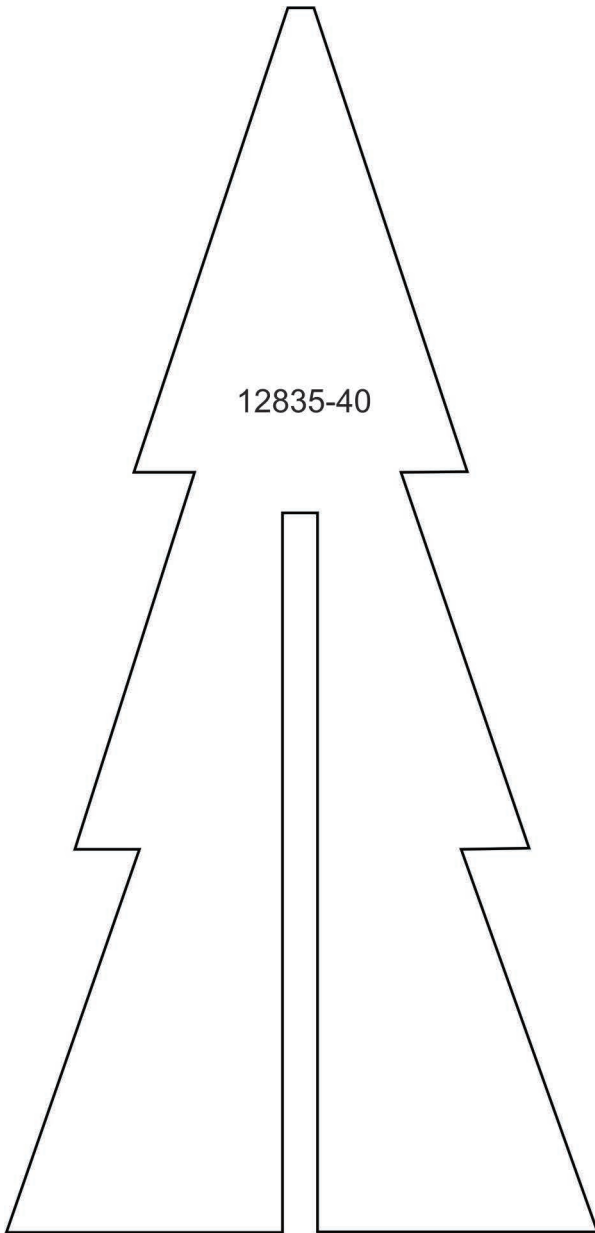

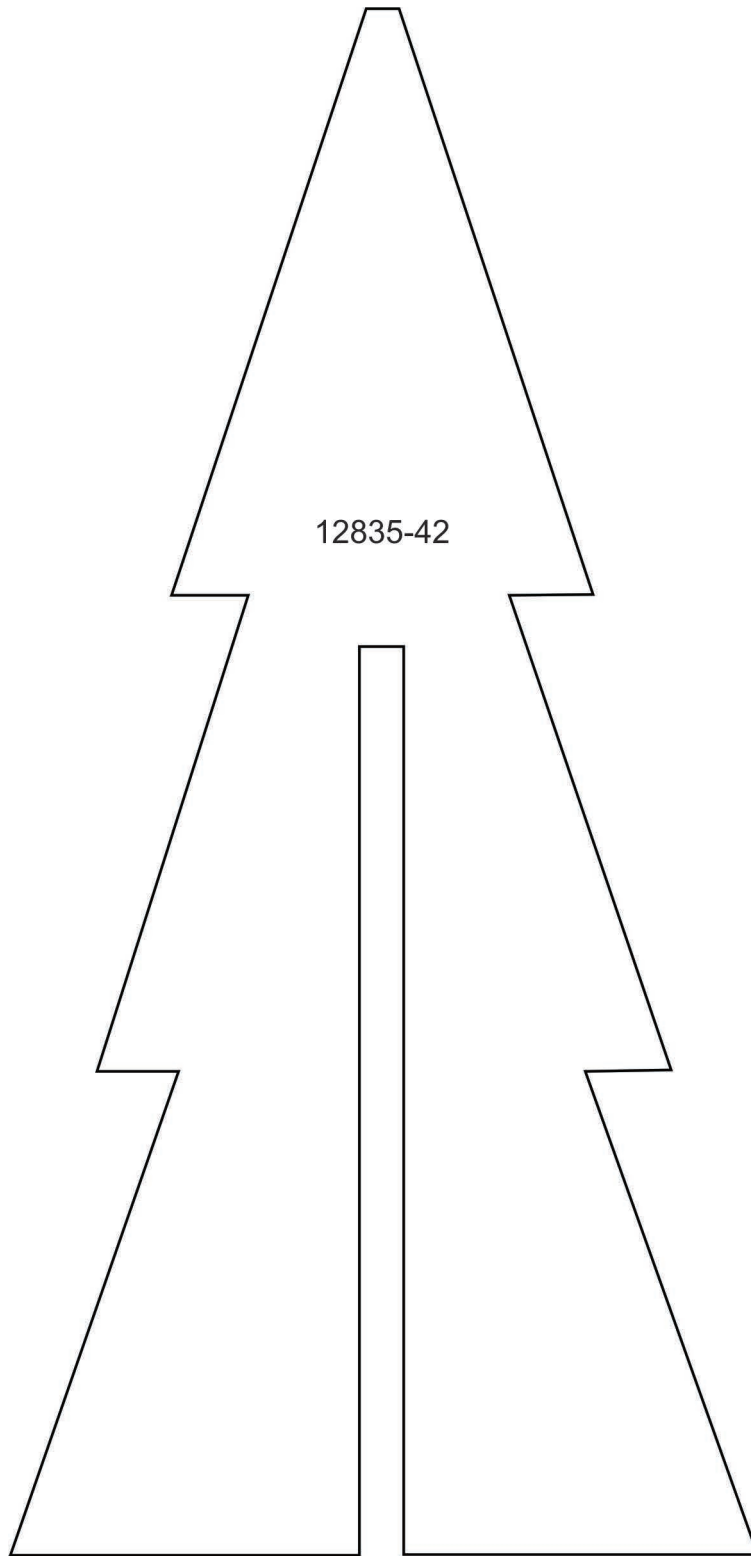

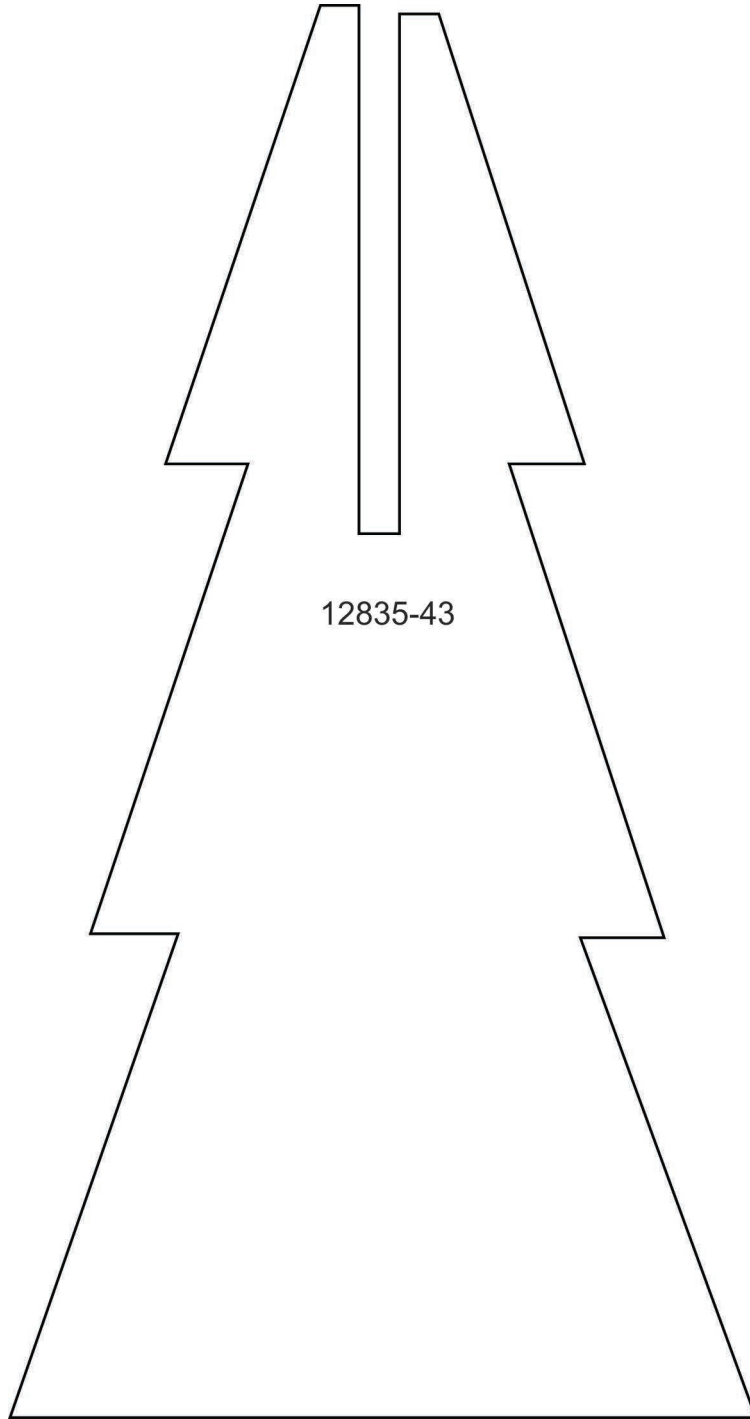

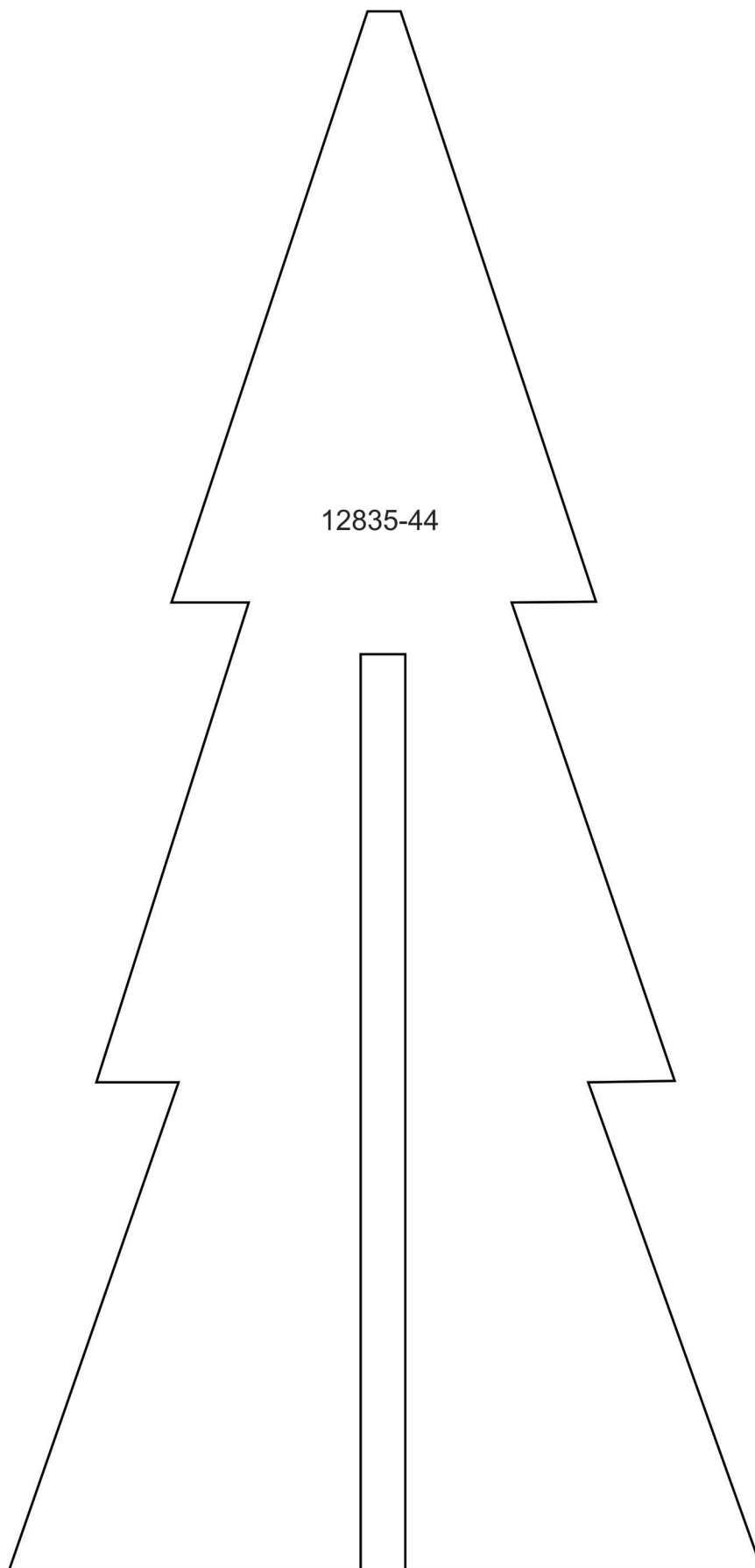

APPLIQUE PATTERNS

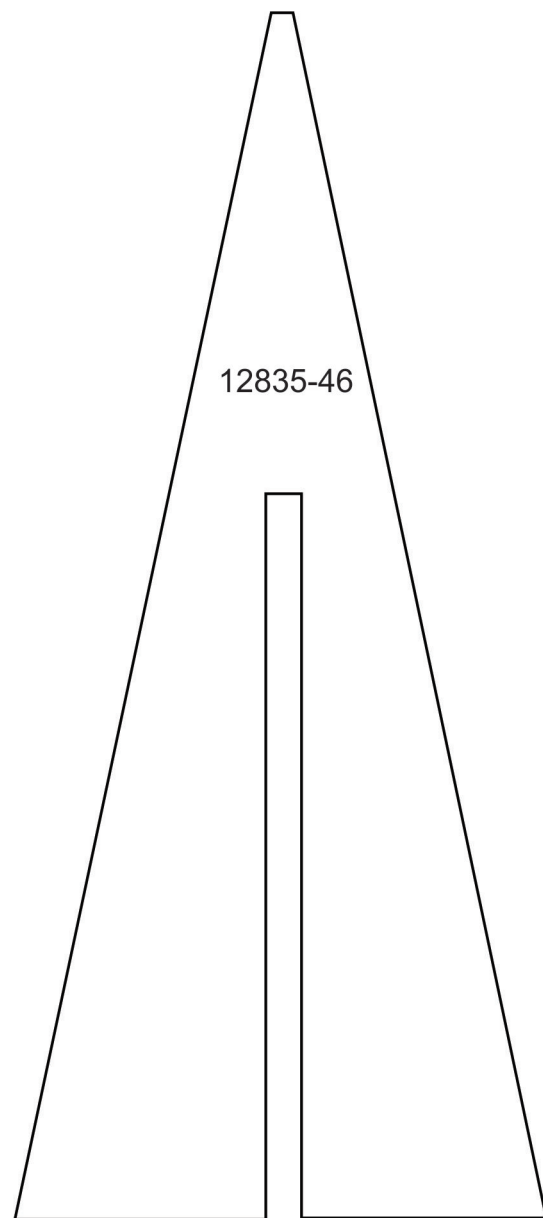
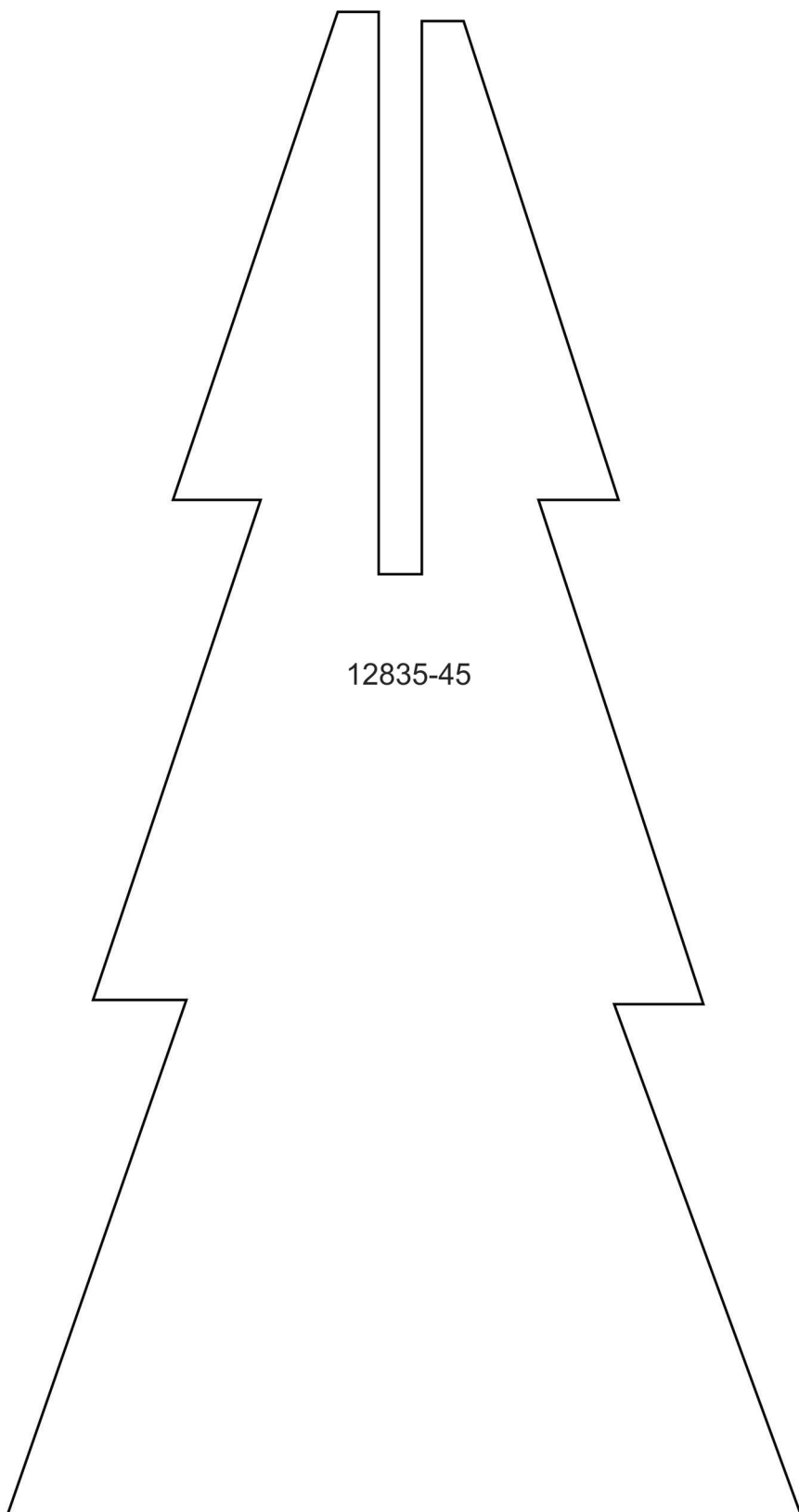

APPLIQUE PATTERNS

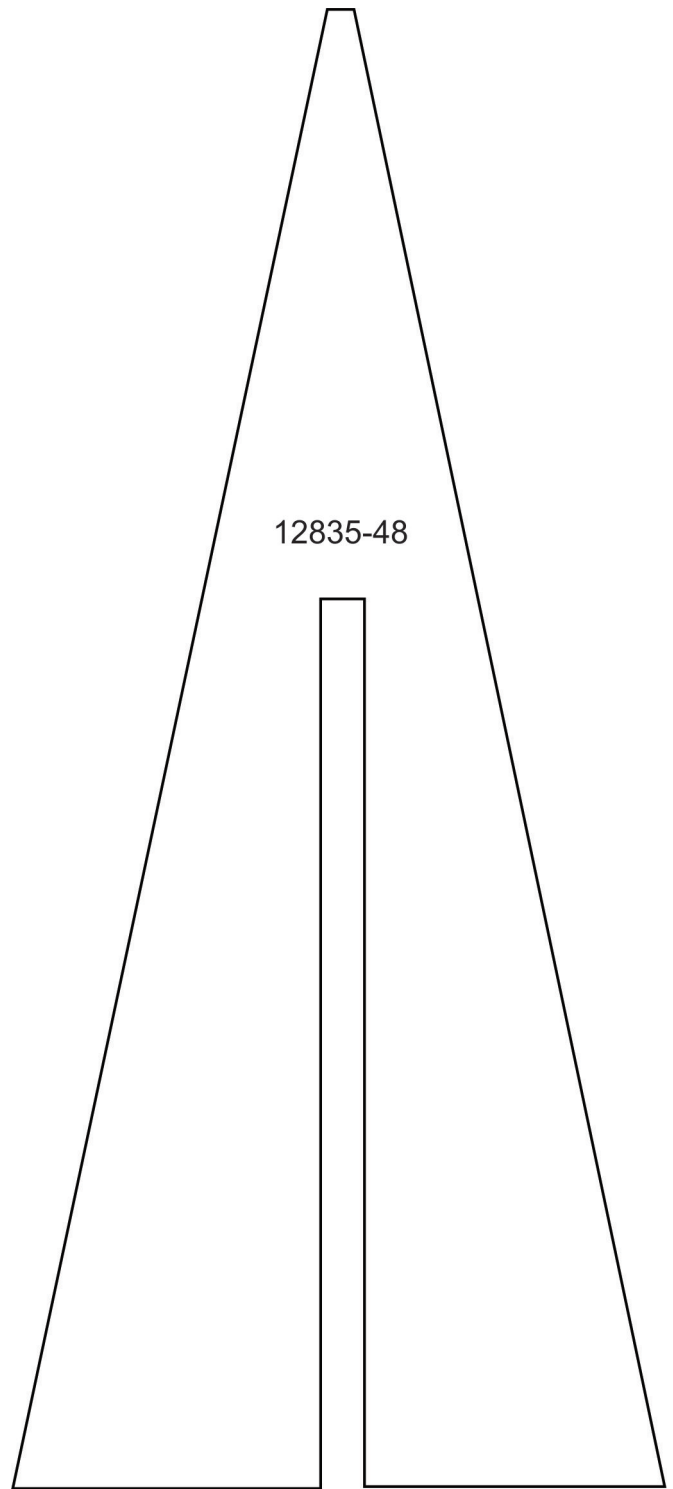
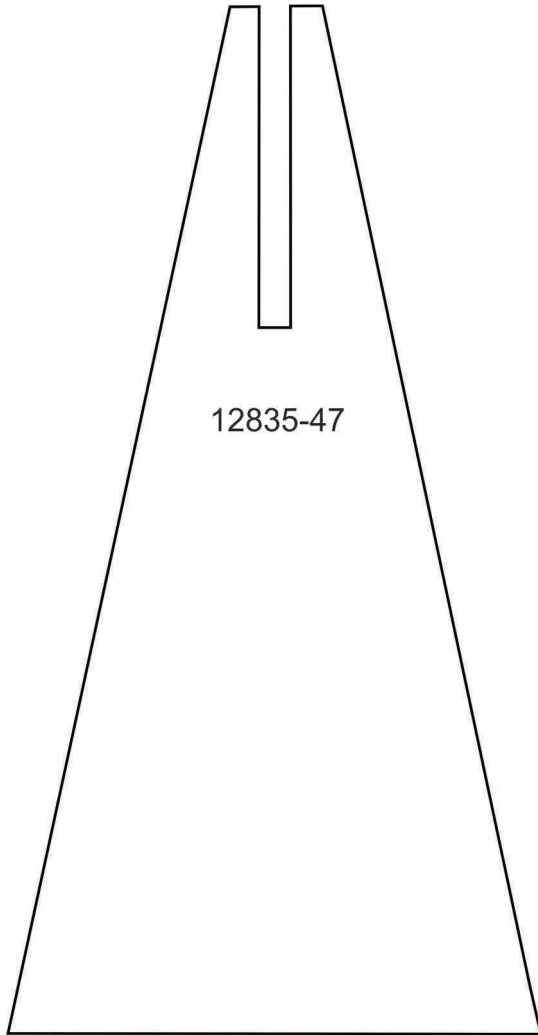

APPLIQUE PATTERNS

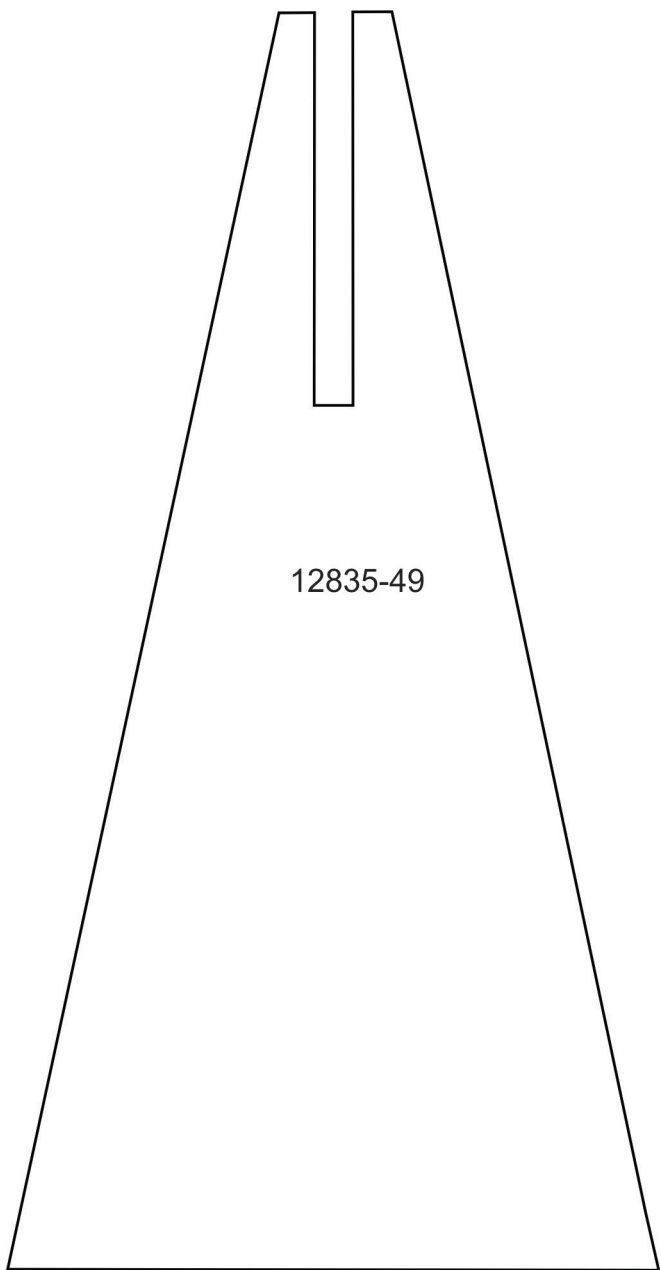

12835-49

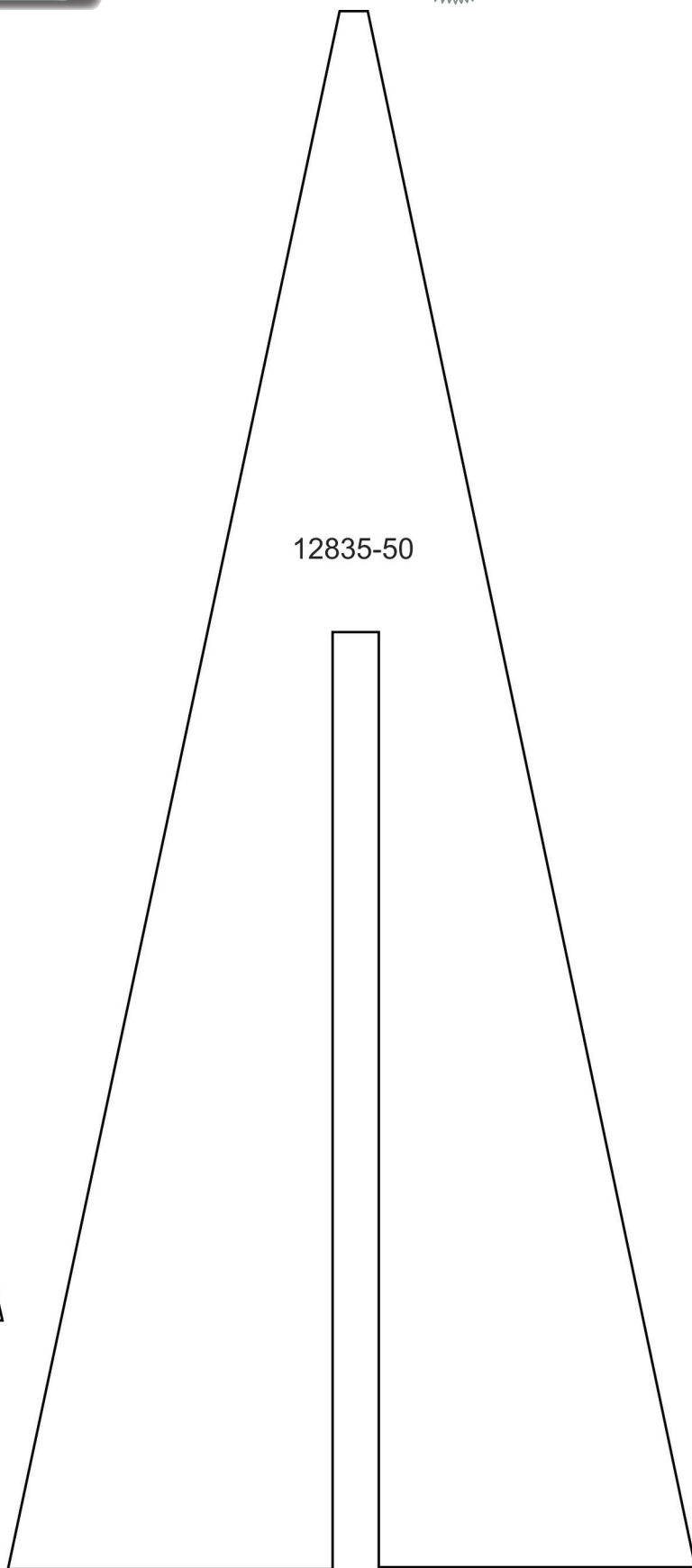

12835-50

APPLIQUE PATTERNS

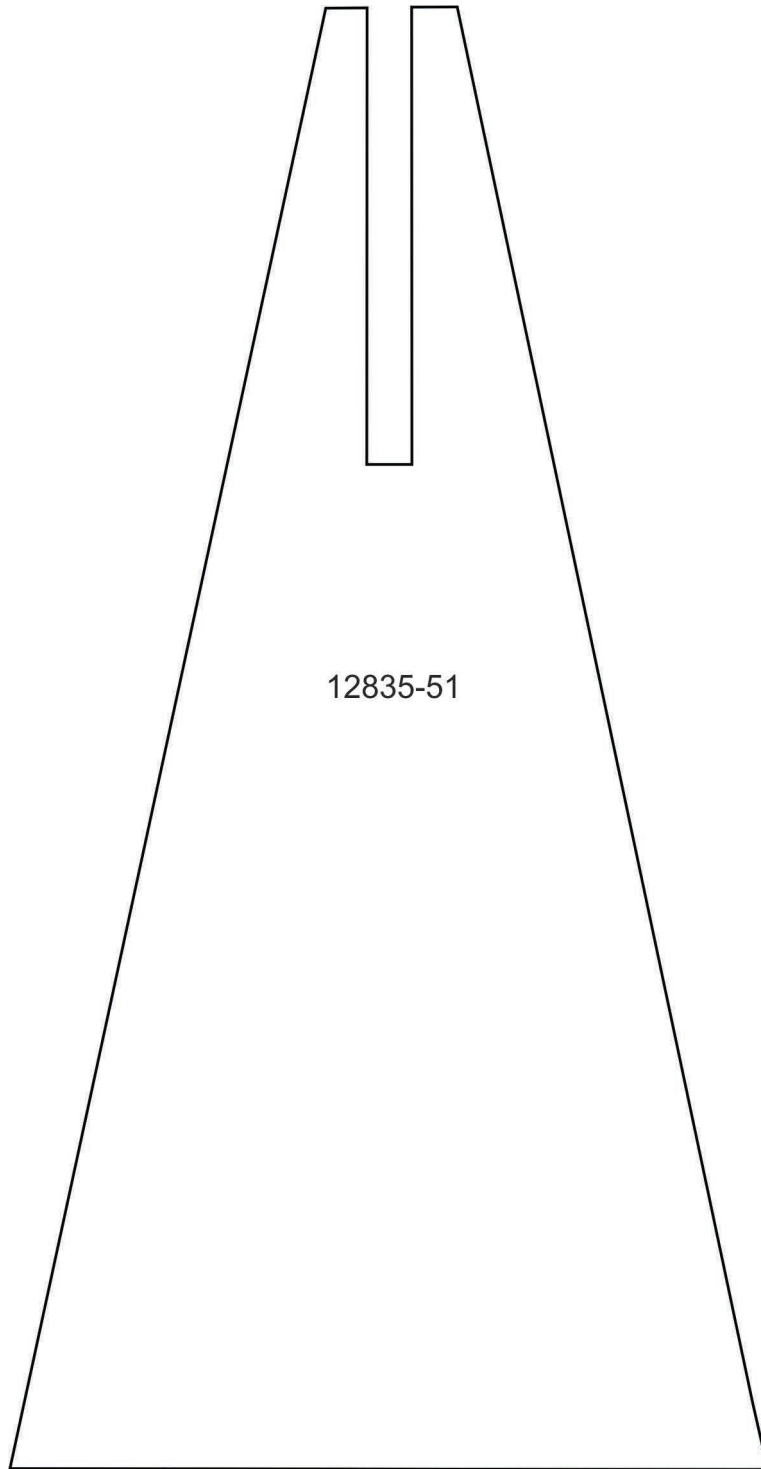

MIRRORED PATTERNS

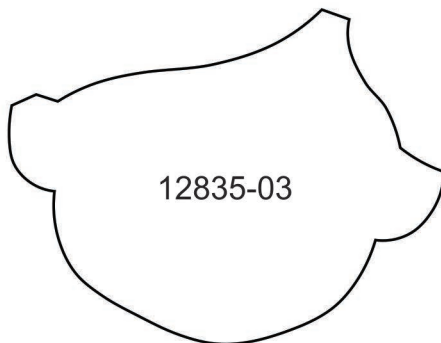
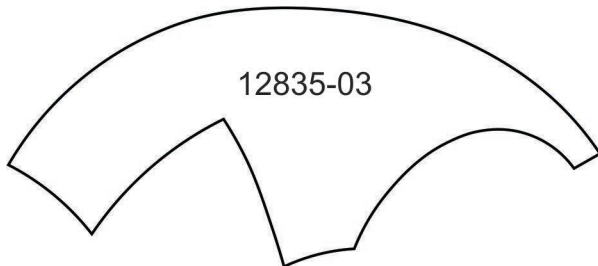
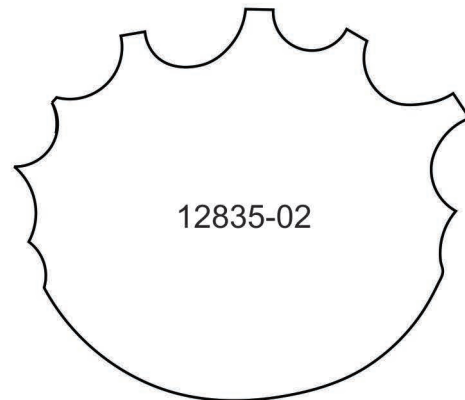
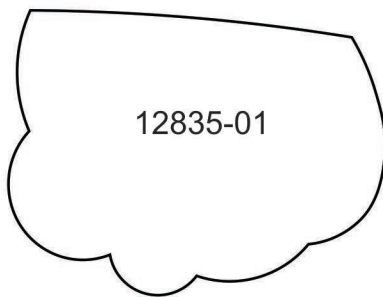
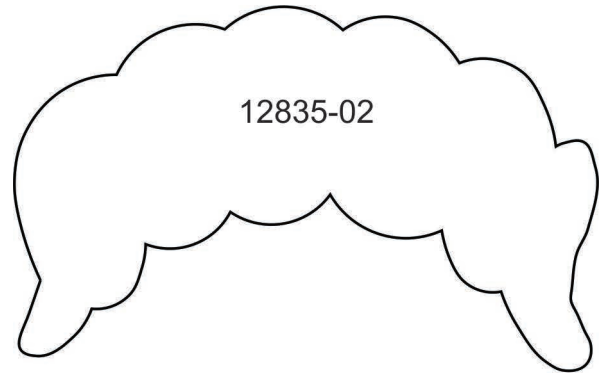
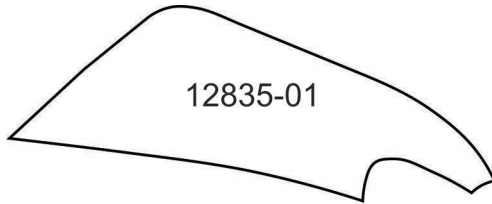

MIRRORED PATTERNS

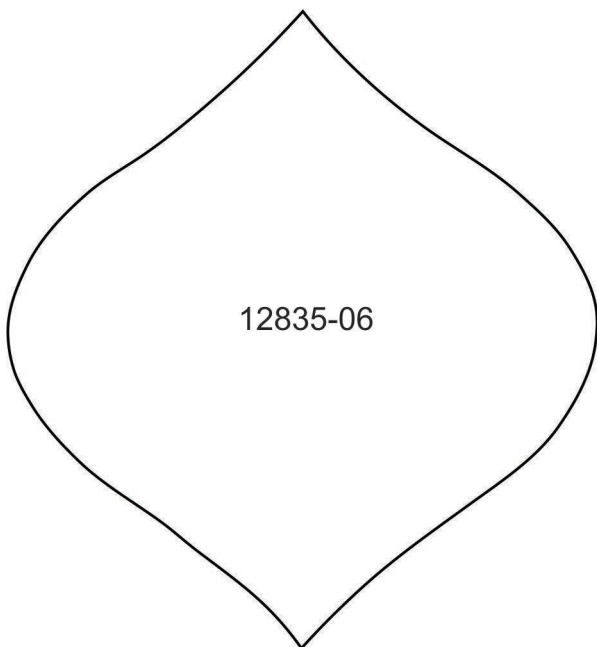
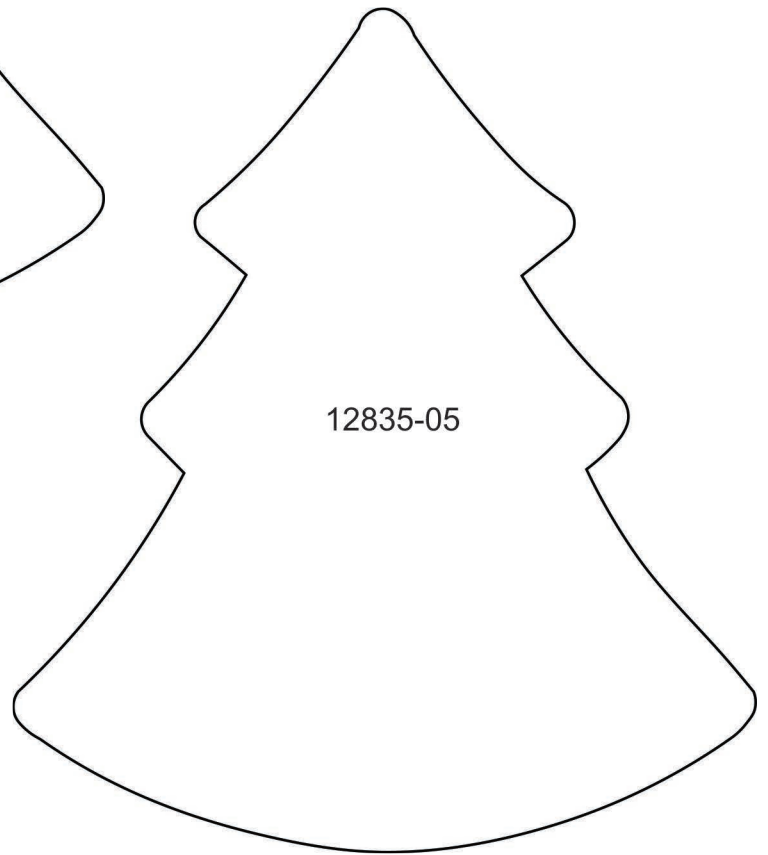
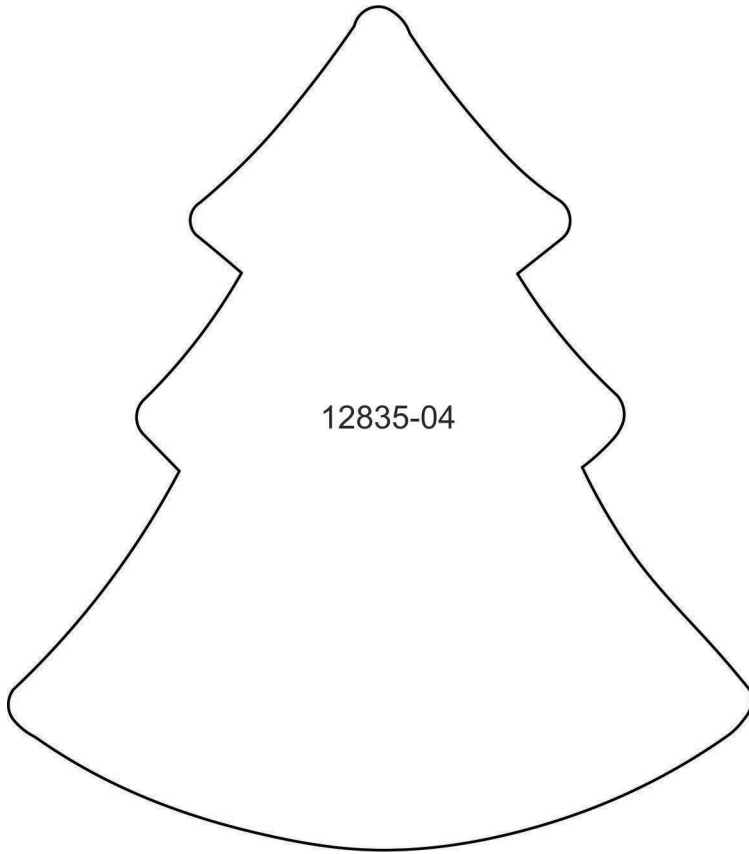

MIRRORED PATTERNS

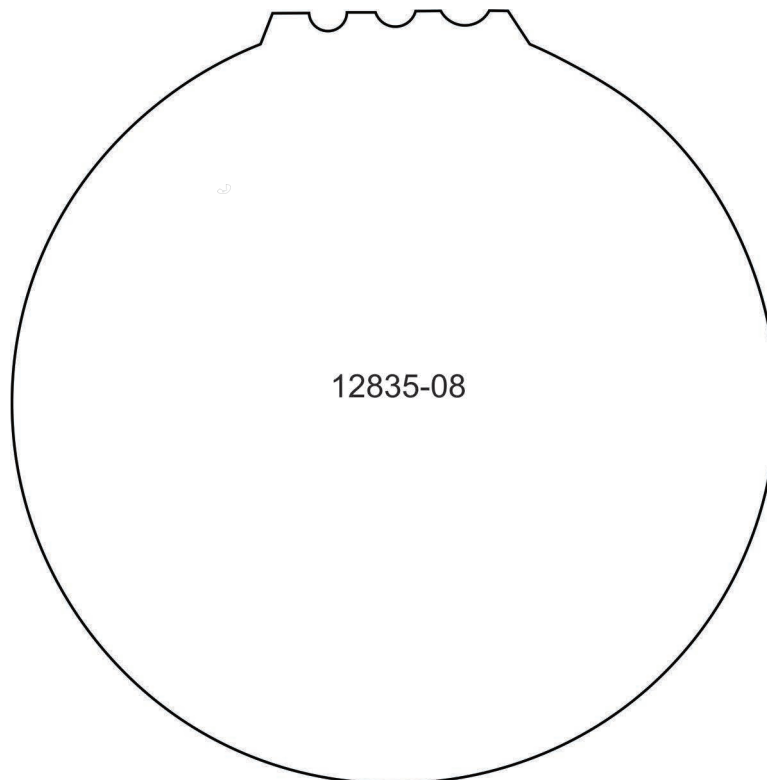
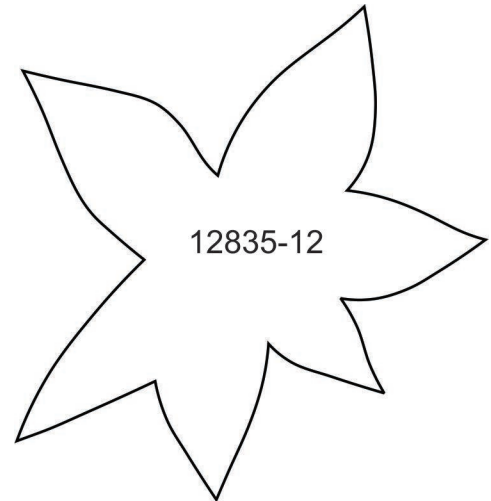
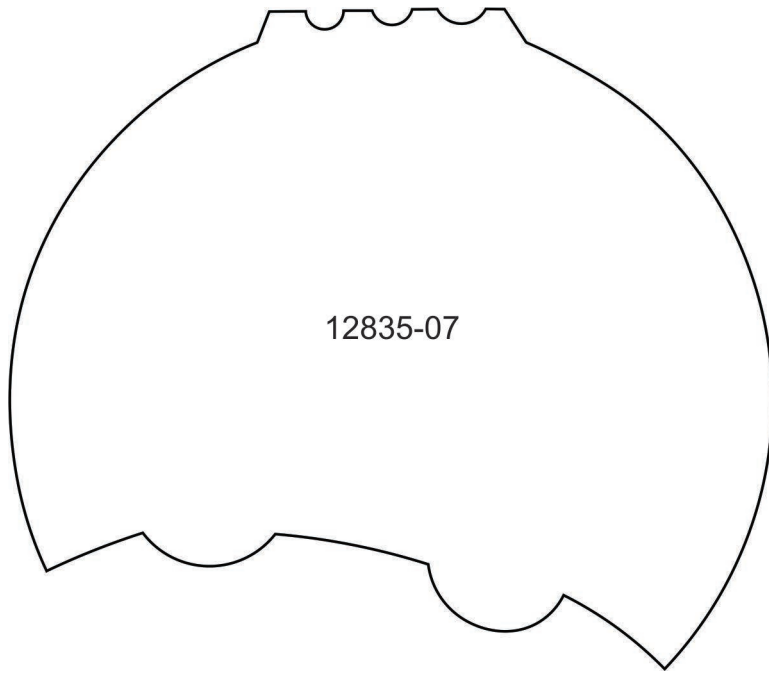

MIRRORED PATTERNS

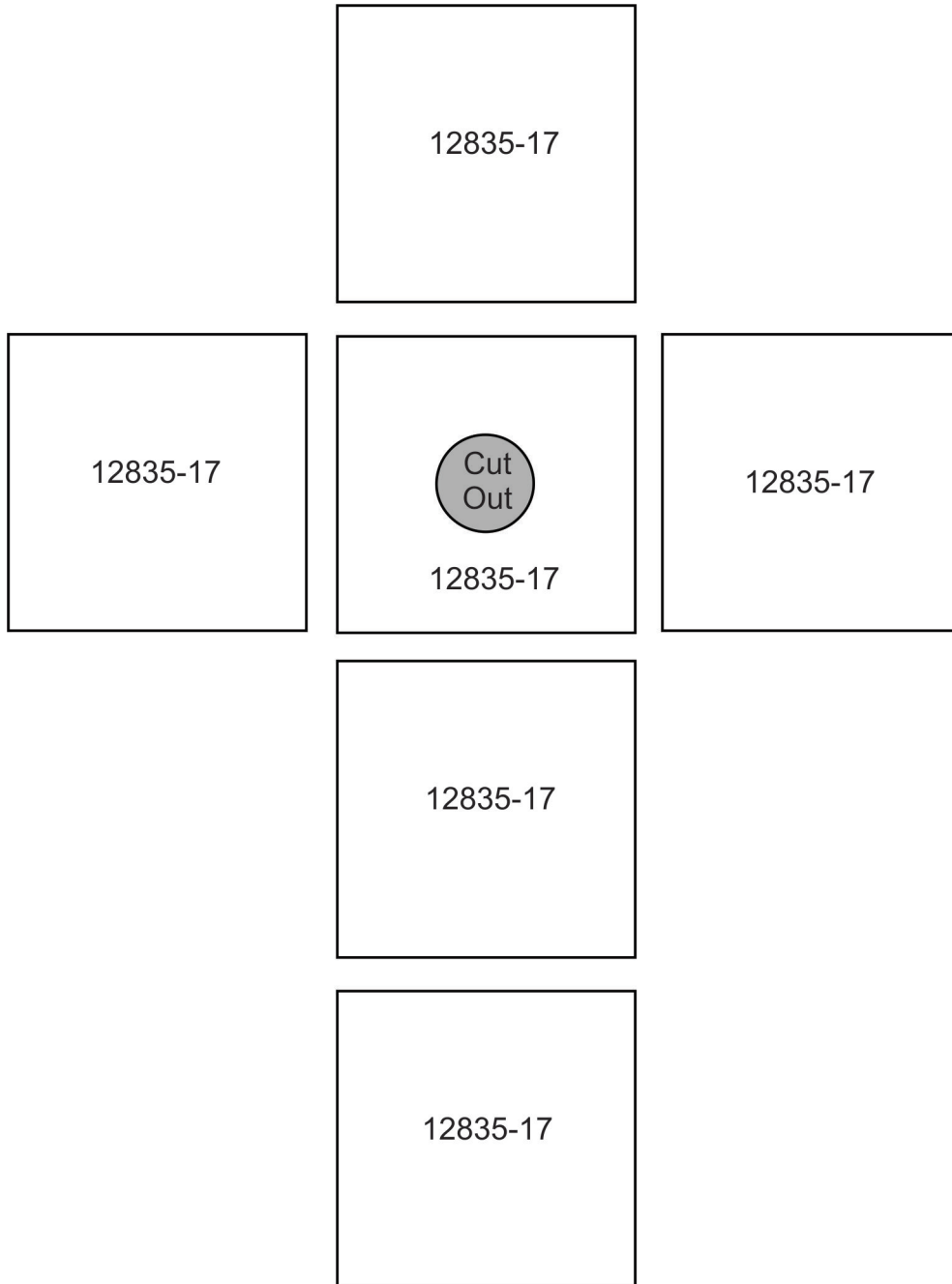

MIRRORED PATTERNS

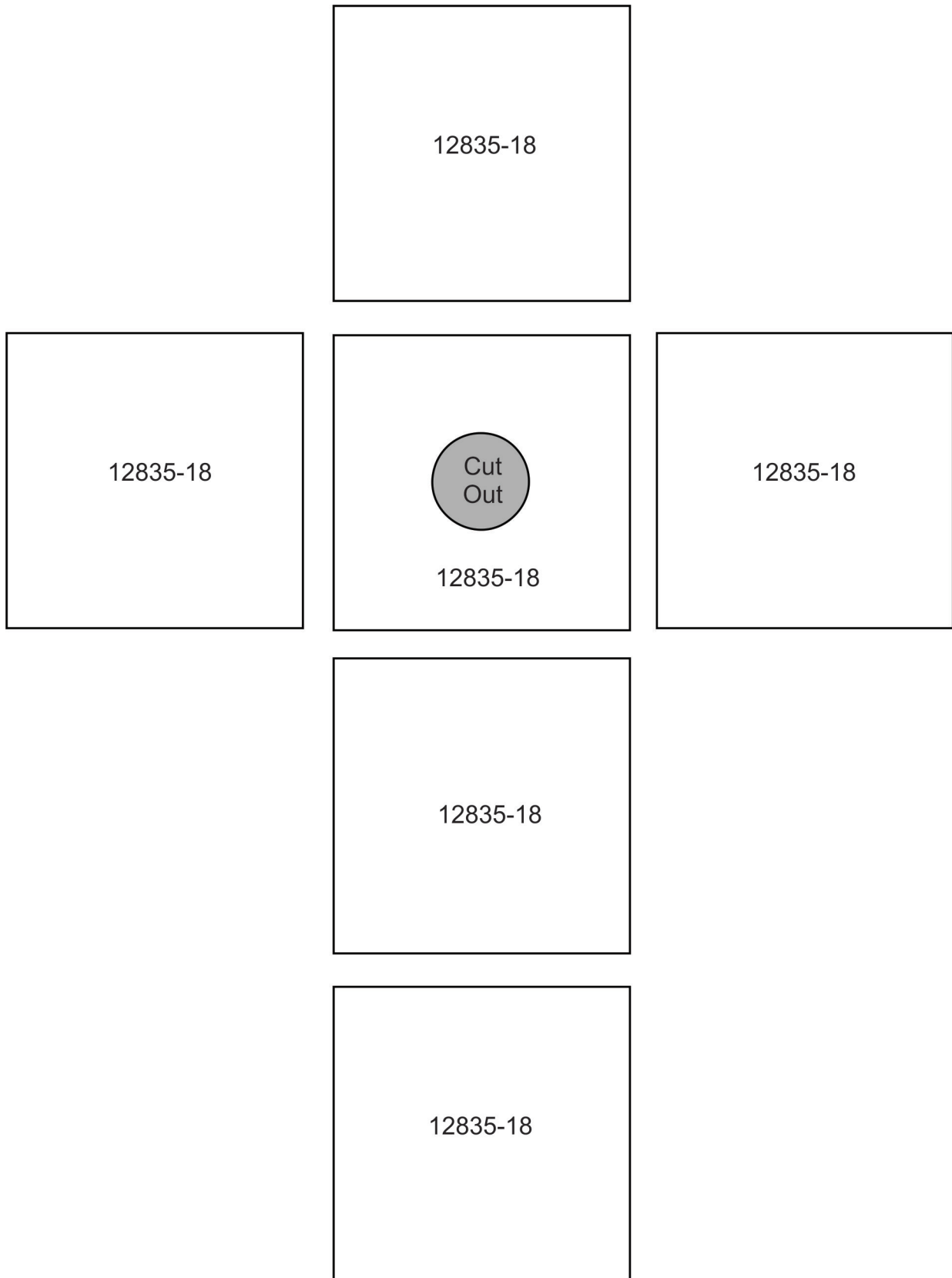

MIRRORED PATTERNS

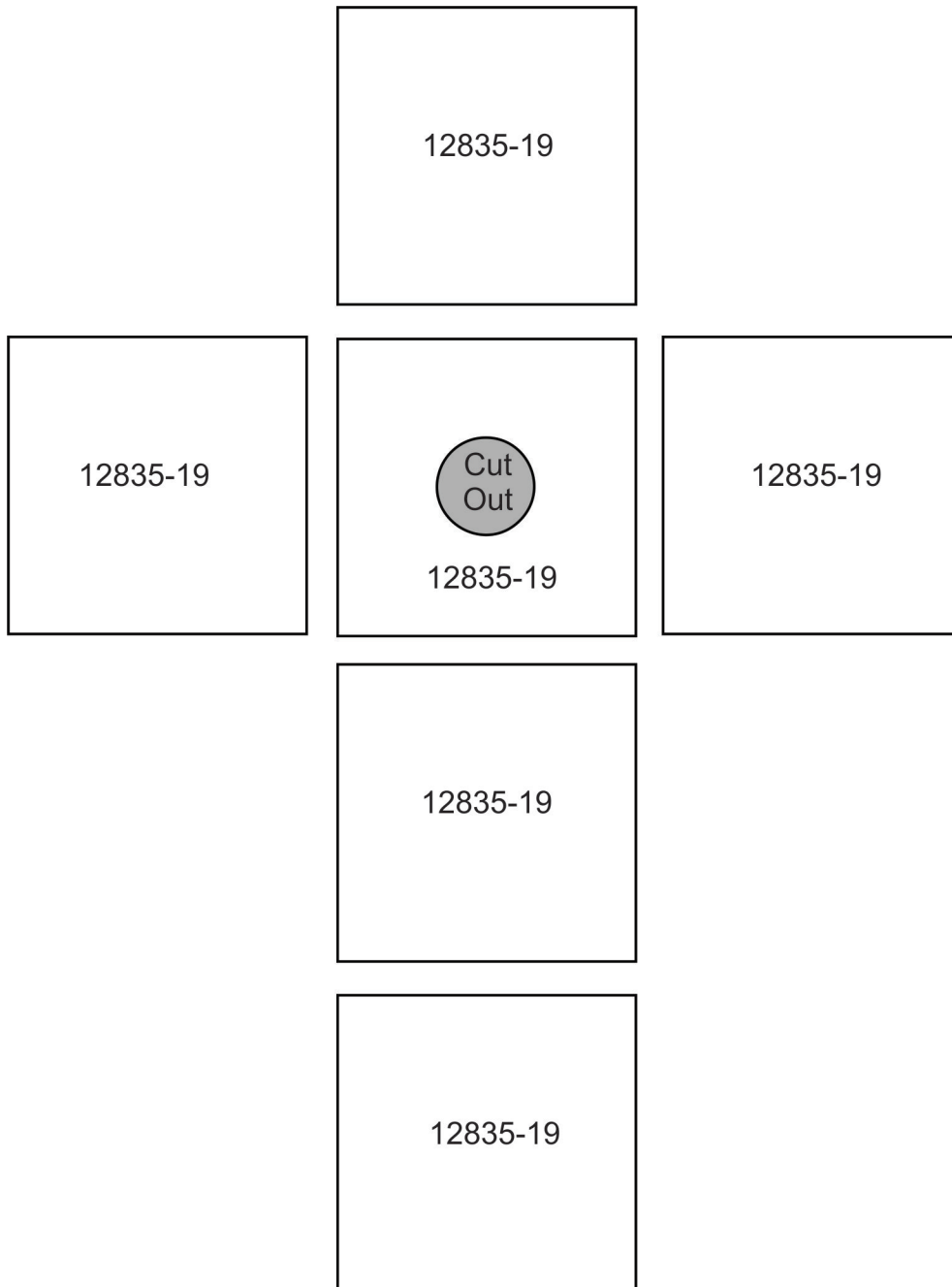

MIRRORED PATTERNS

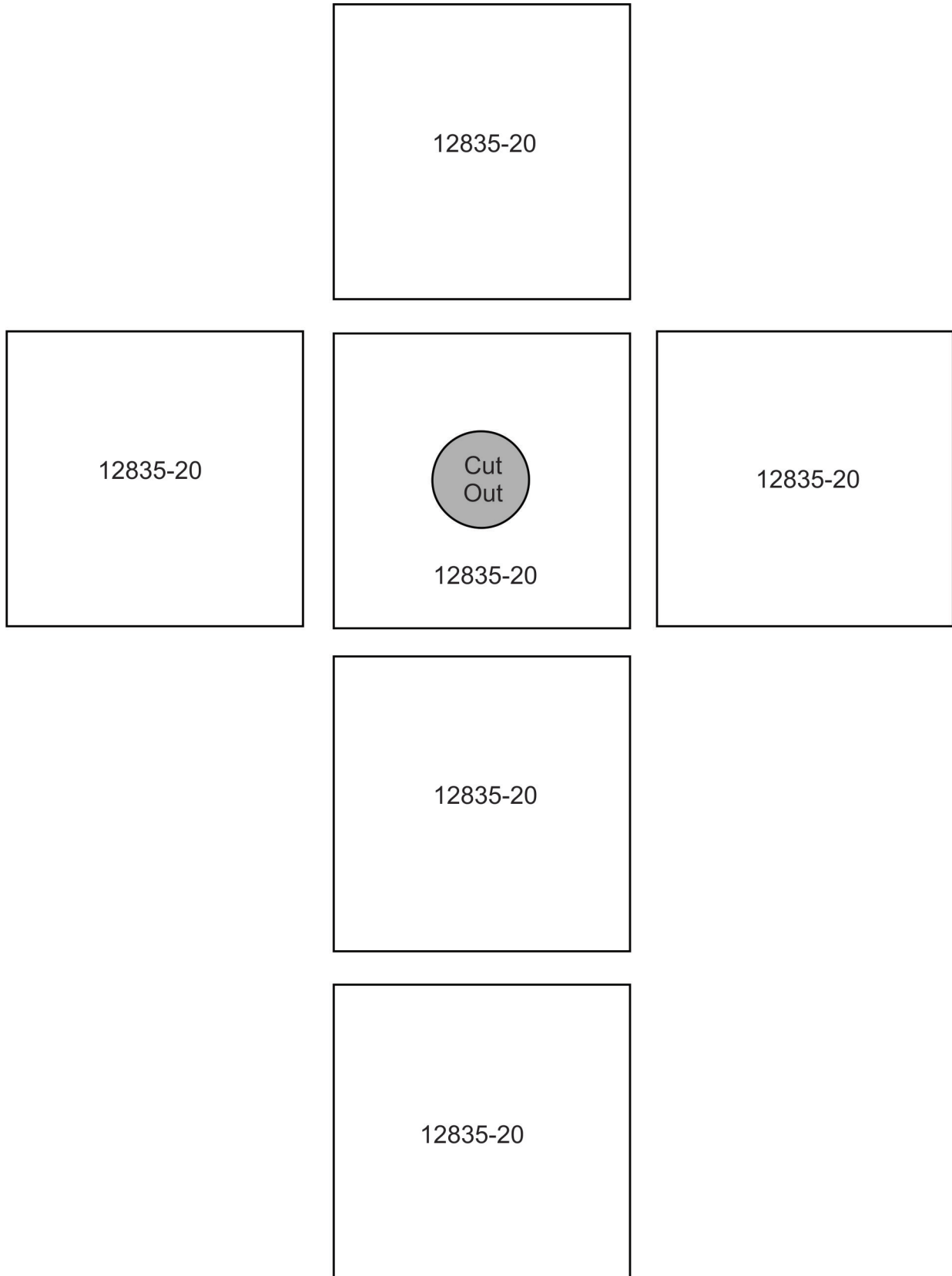

MIRRORED PATTERNS

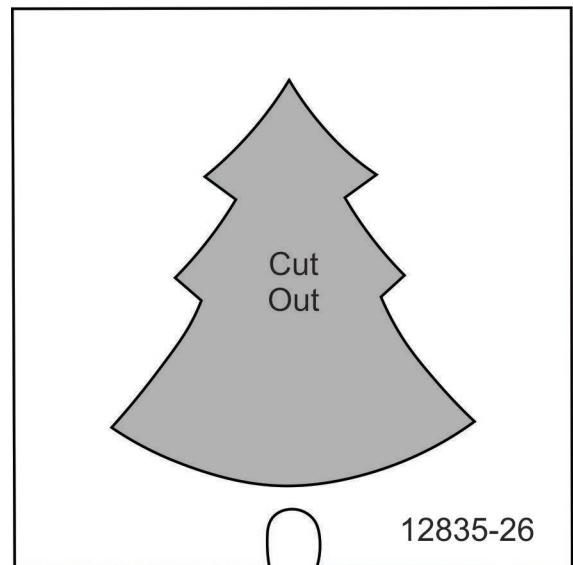
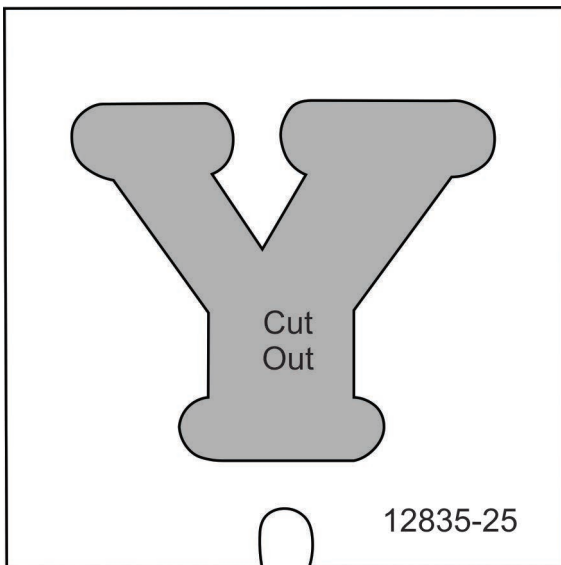
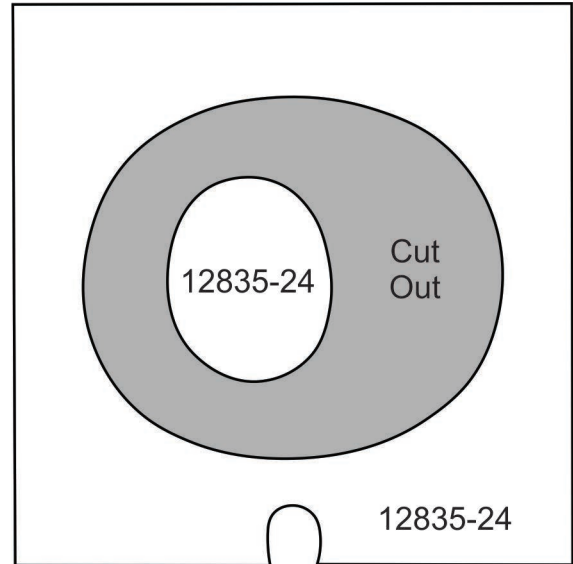
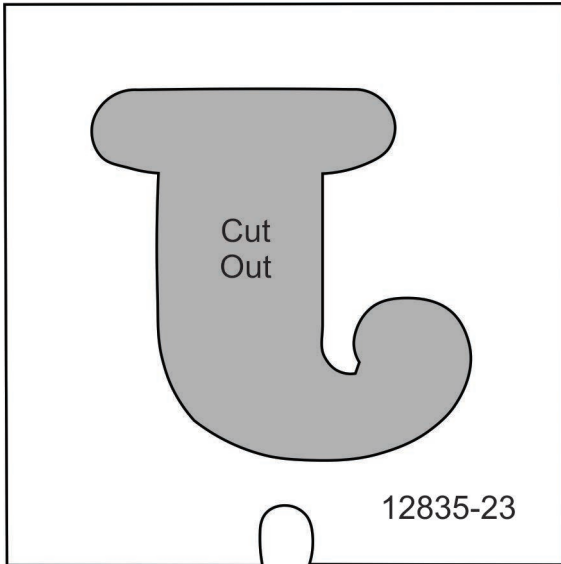

MIRRORED PATTERNS

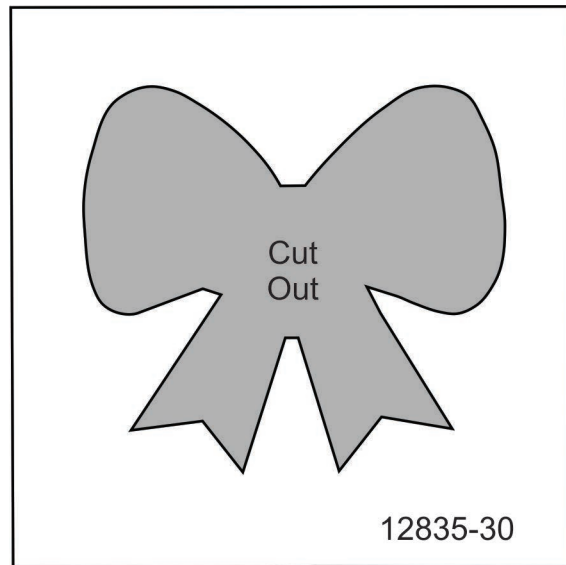
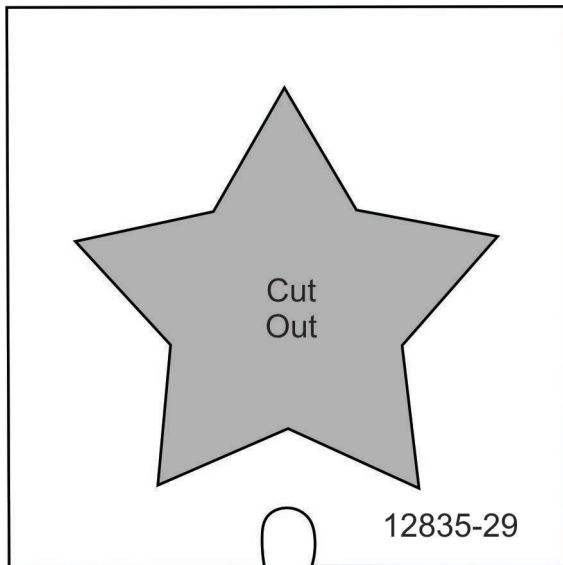
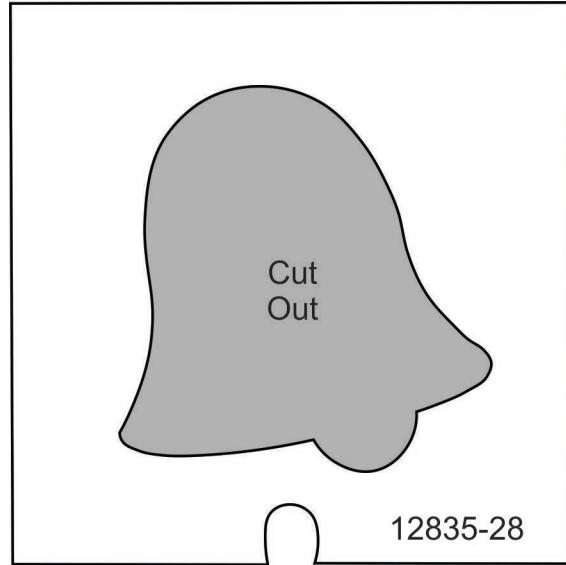
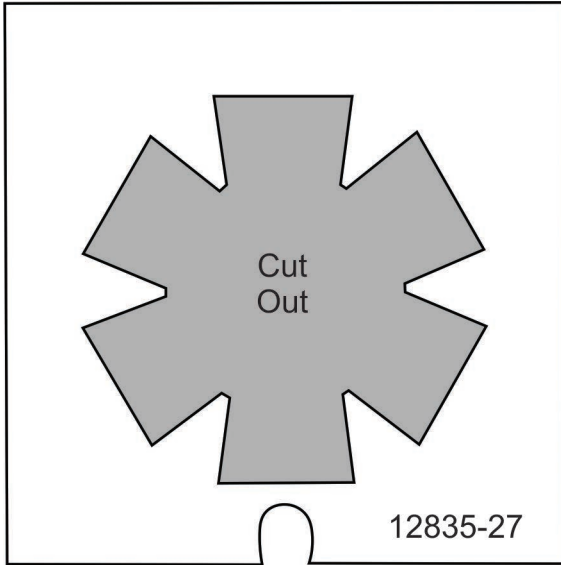

MIRRORED PATTERNS

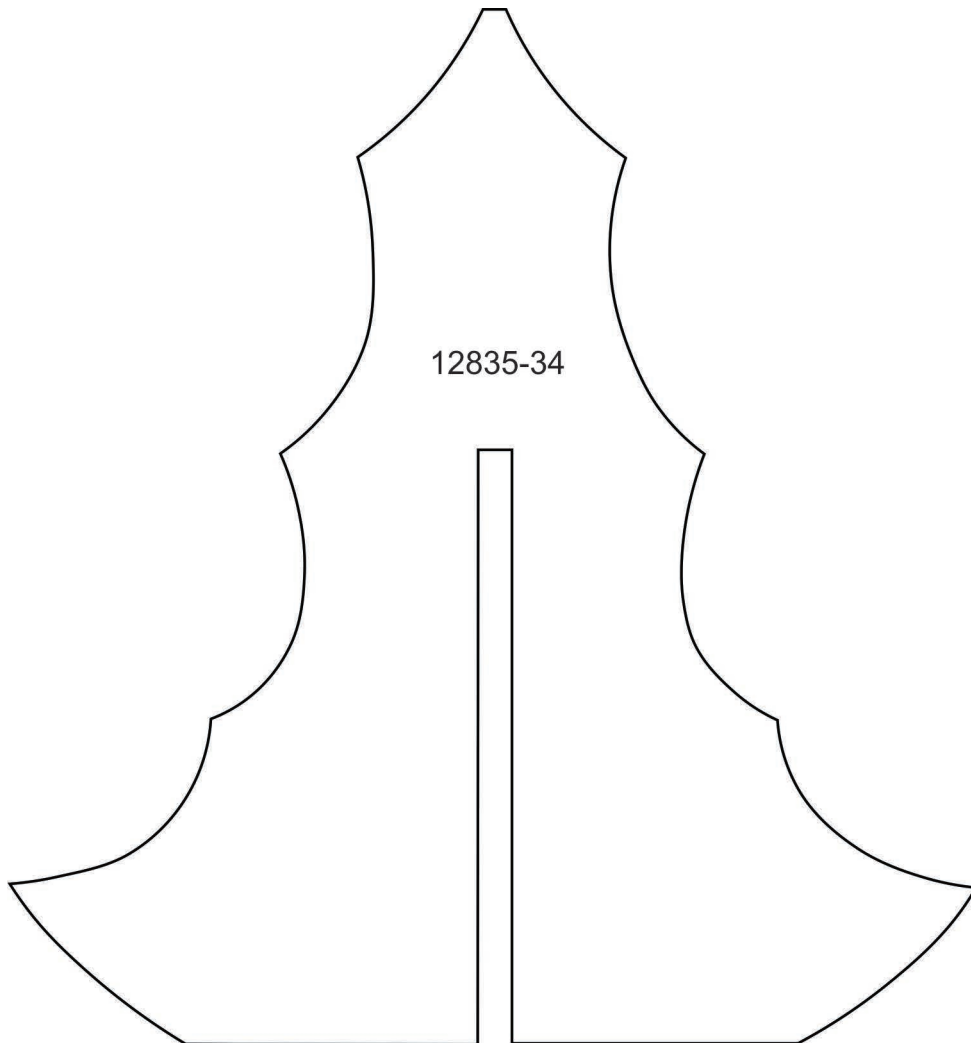
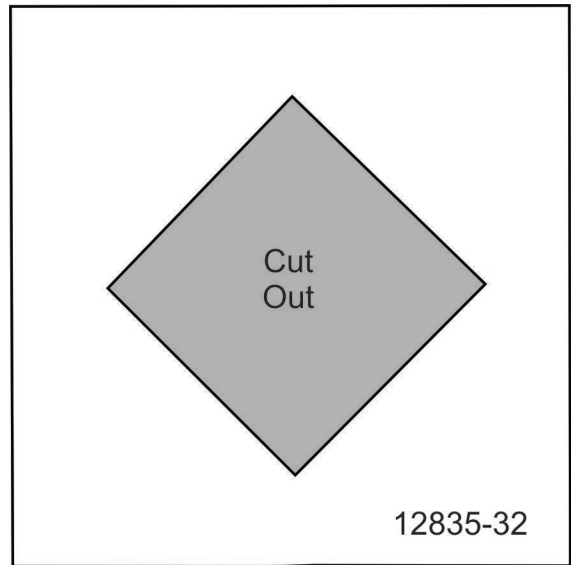
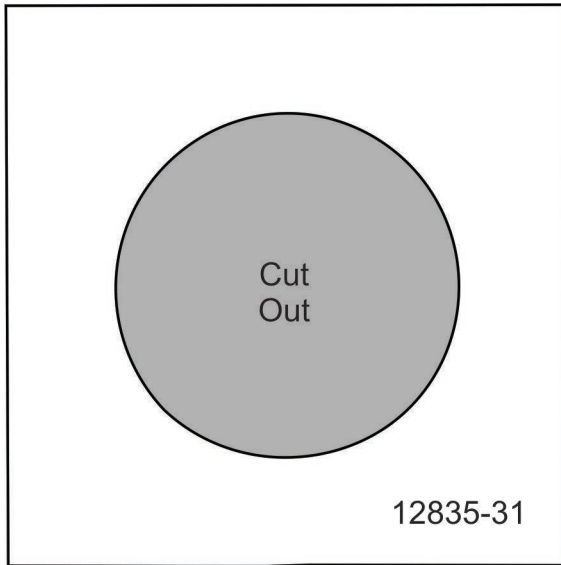

MIRRORED PATTERNS

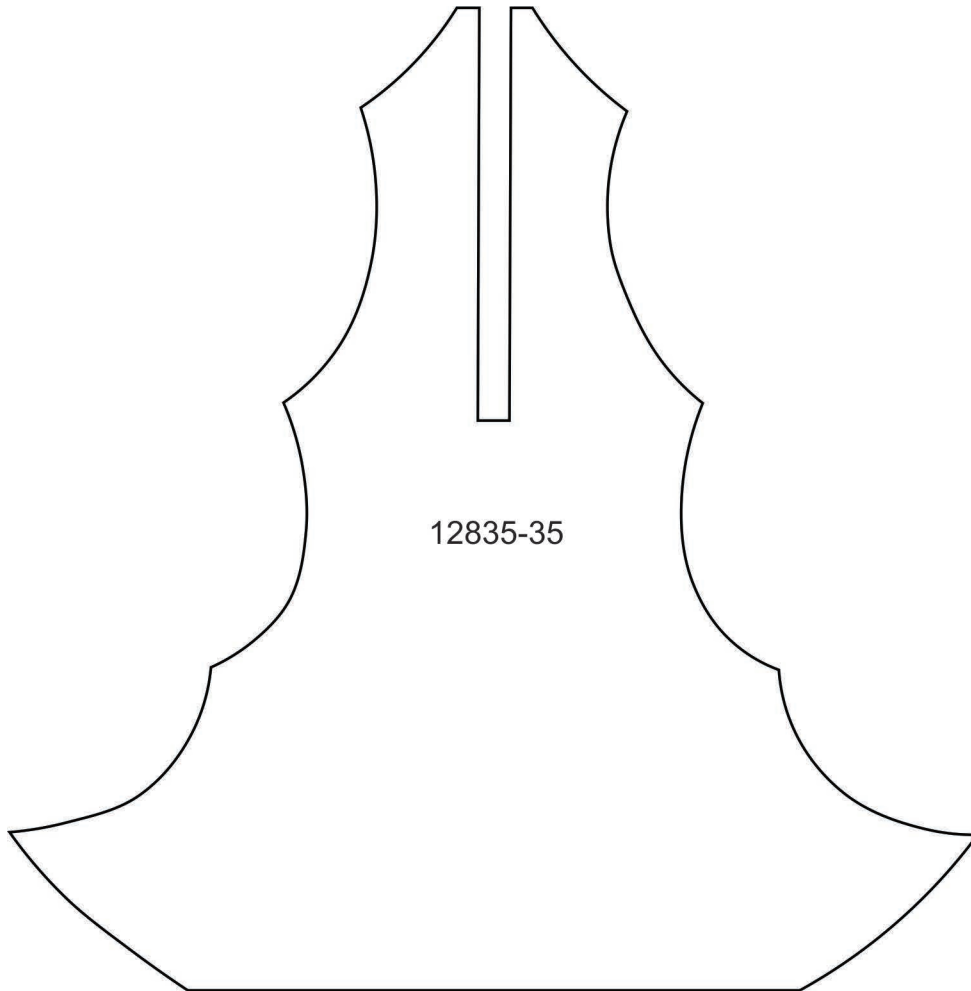

MIRRORED PATTERNS

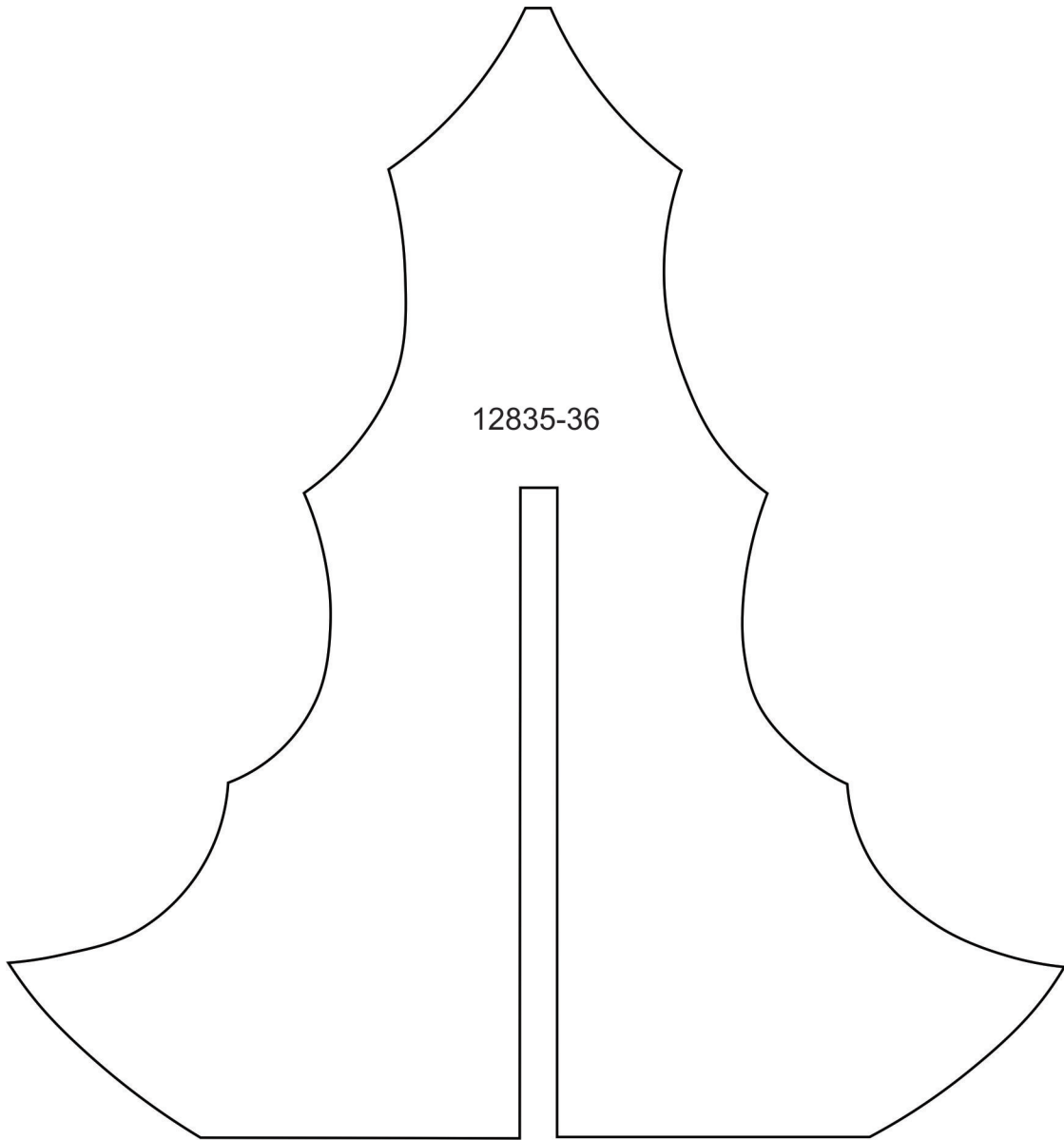

MIRRORED PATTERNS

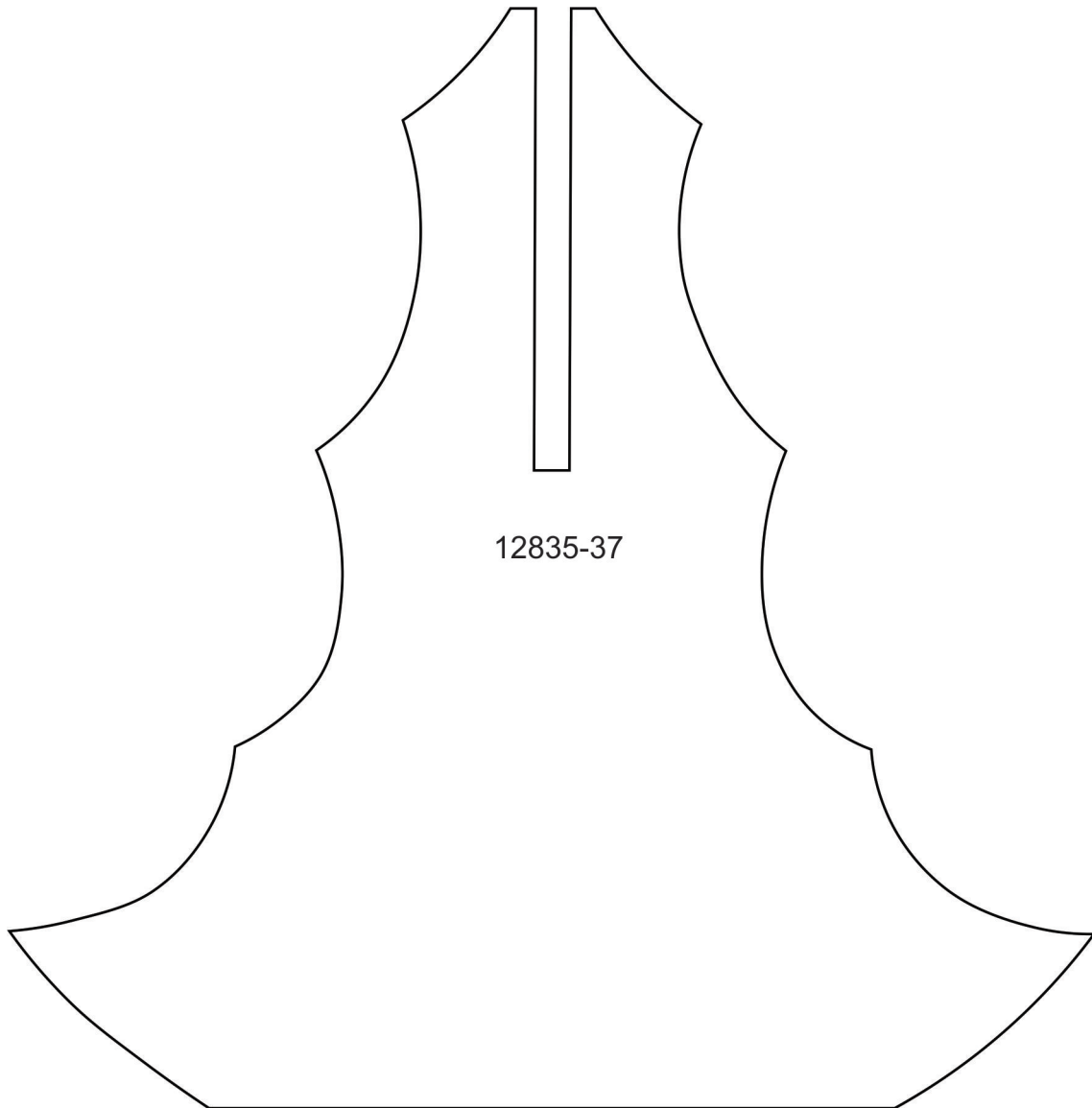

MIRRORED PATTERNS

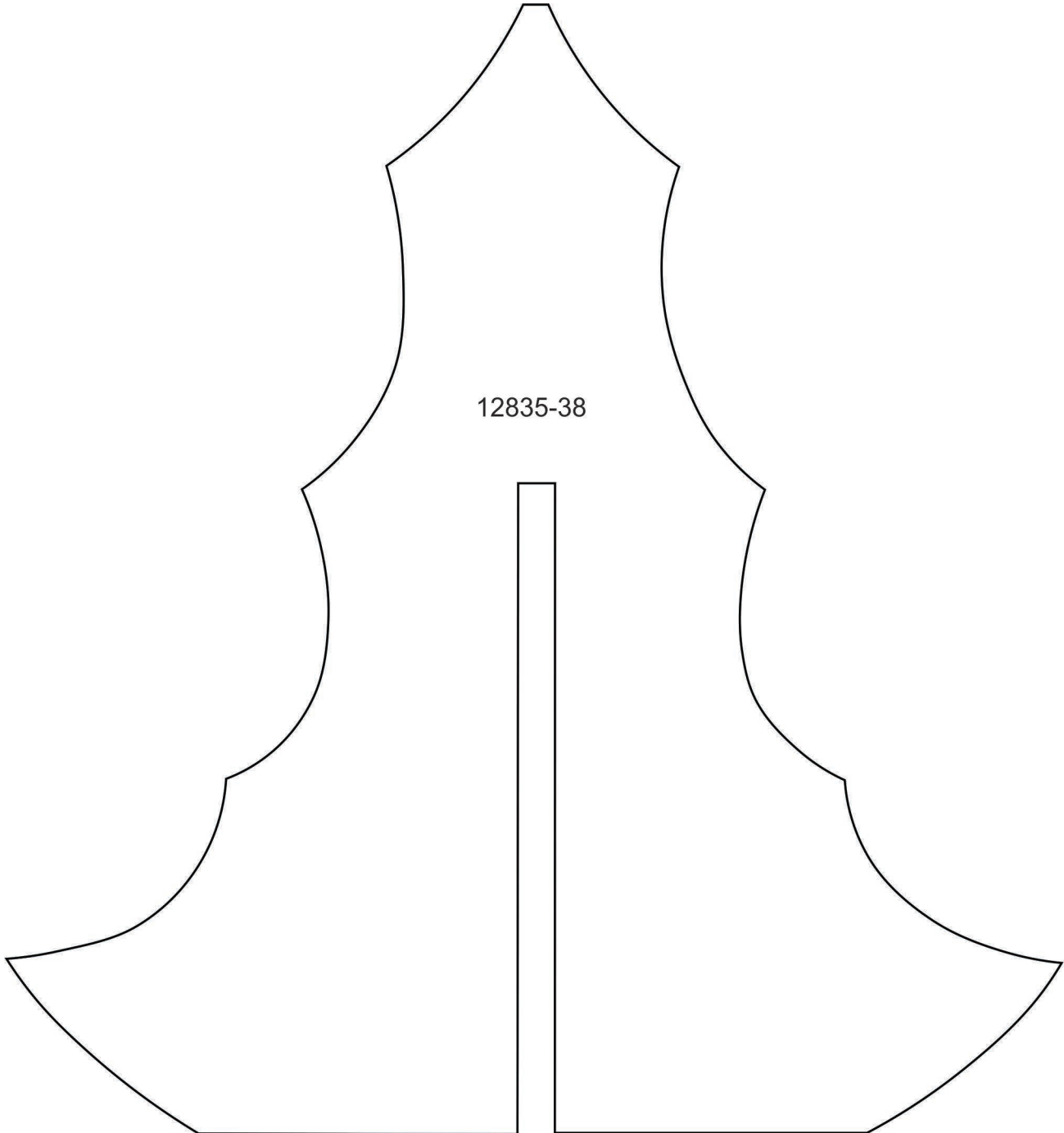

MIRRORED PATTERNS

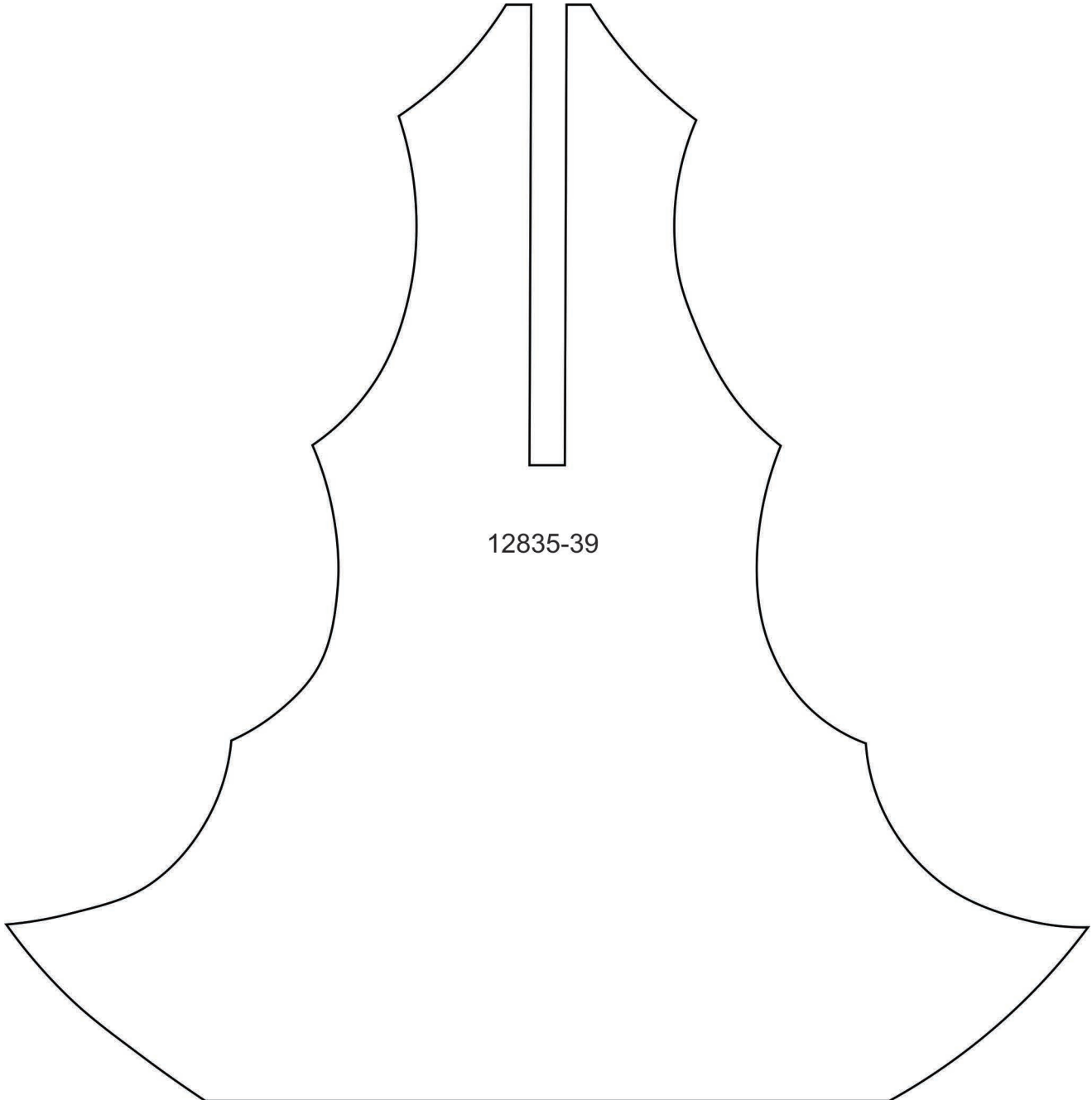

MIRRORED PATTERNS

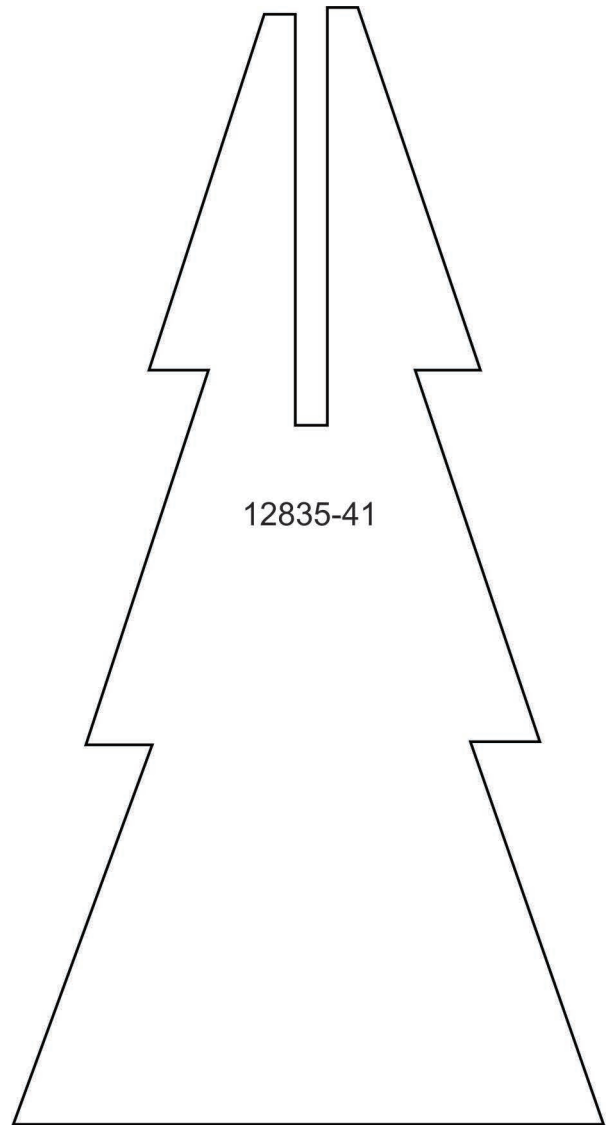
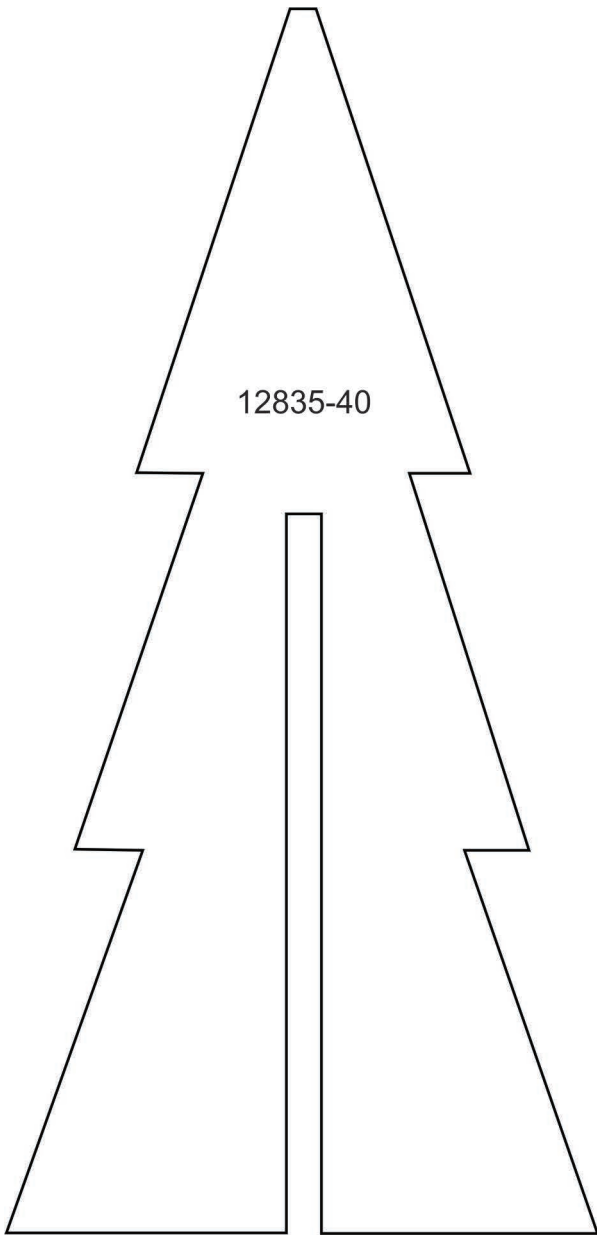

MIRRORED PATTERNS

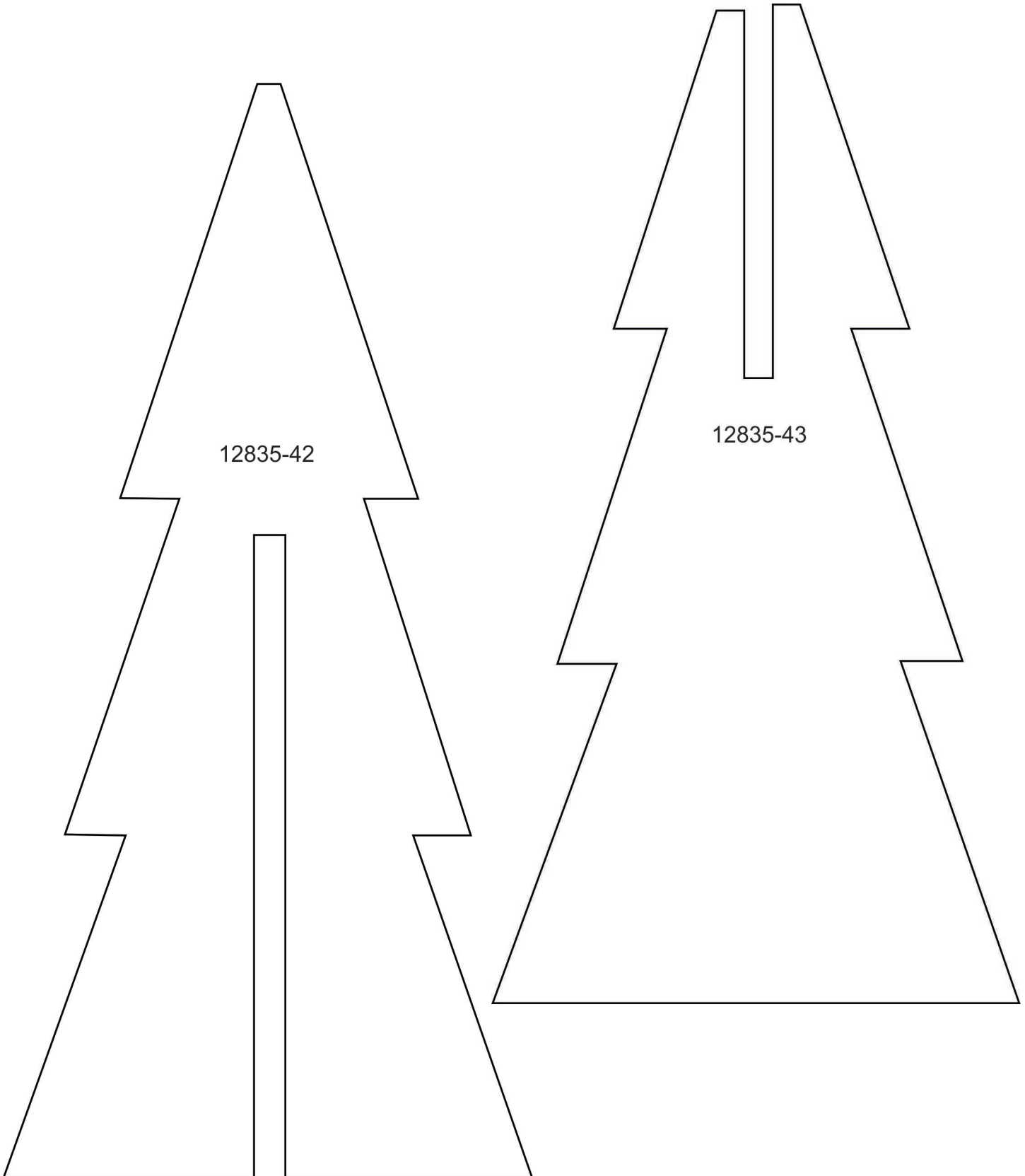

MIRRORED PATTERNS



12835-44

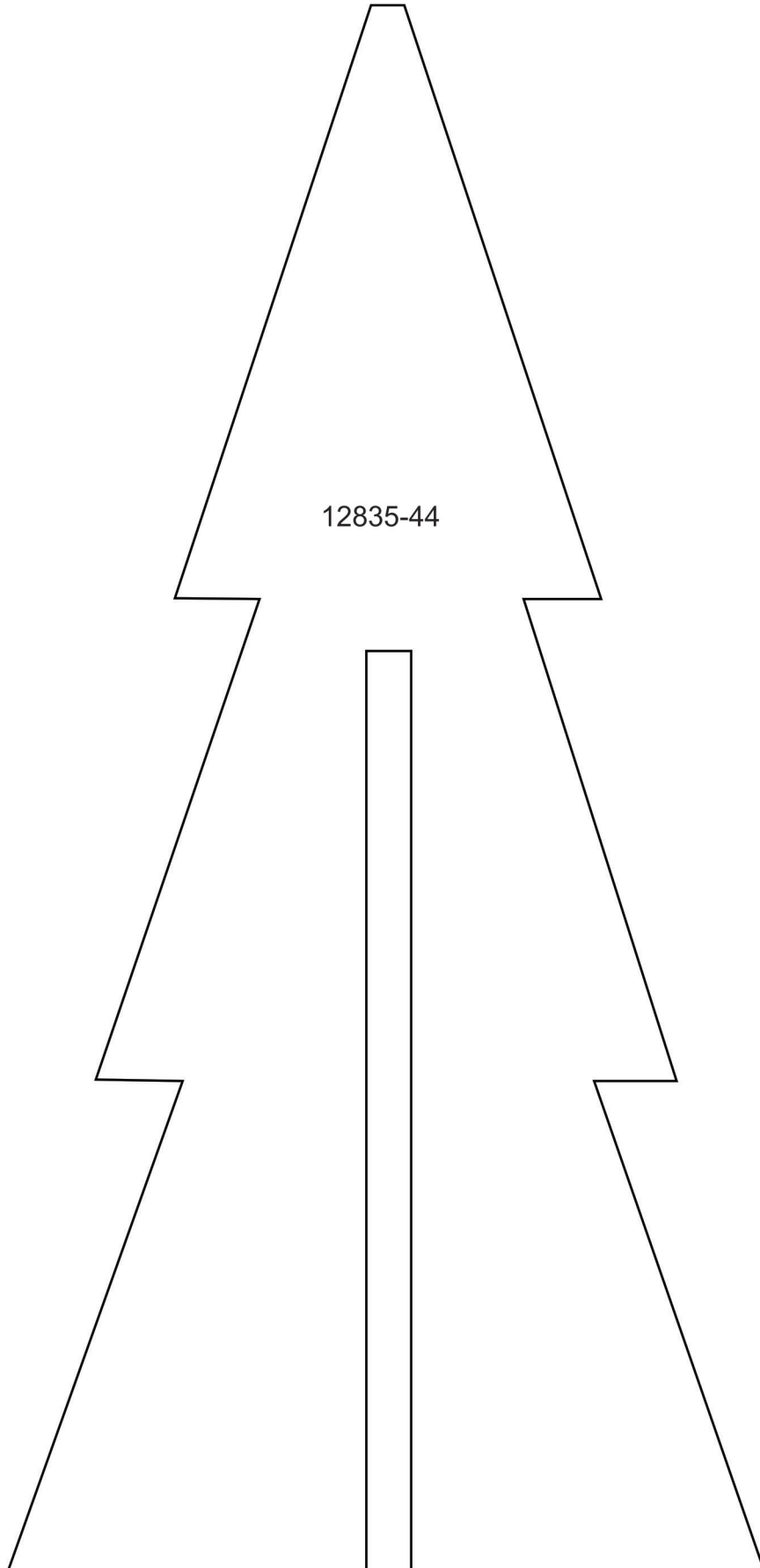

MIRRORED PATTERNS

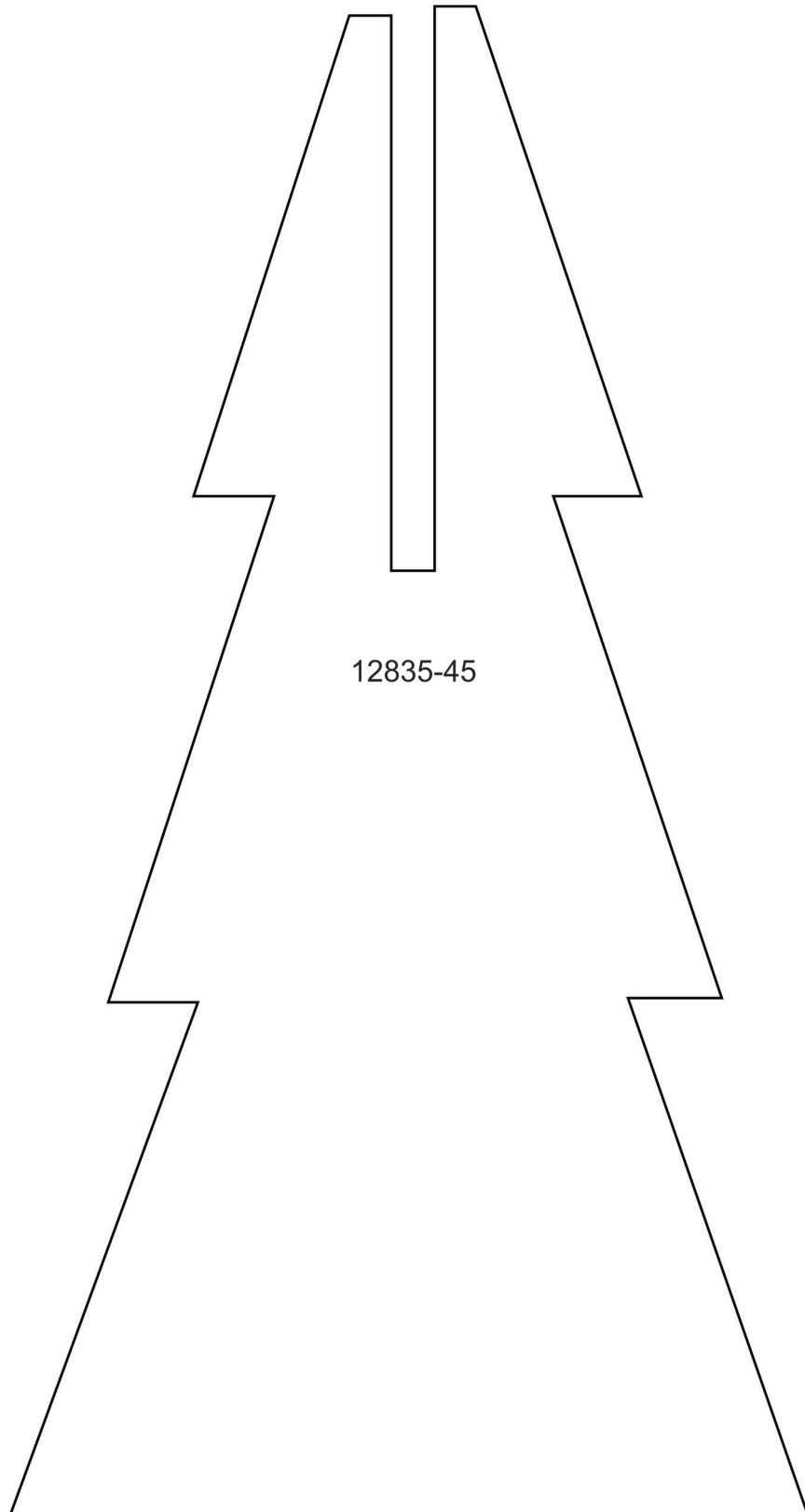

12835-45

MIRRORED PATTERNS

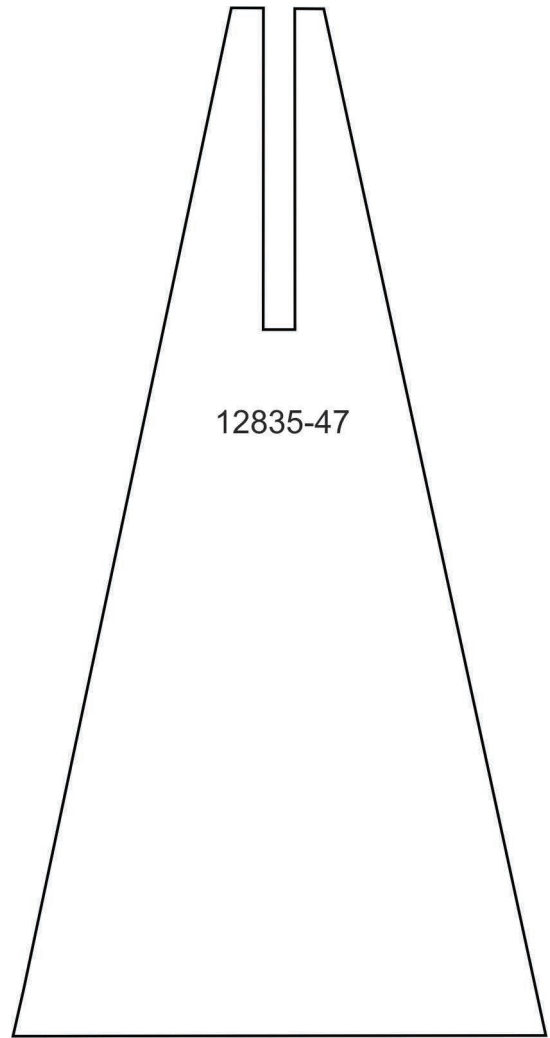
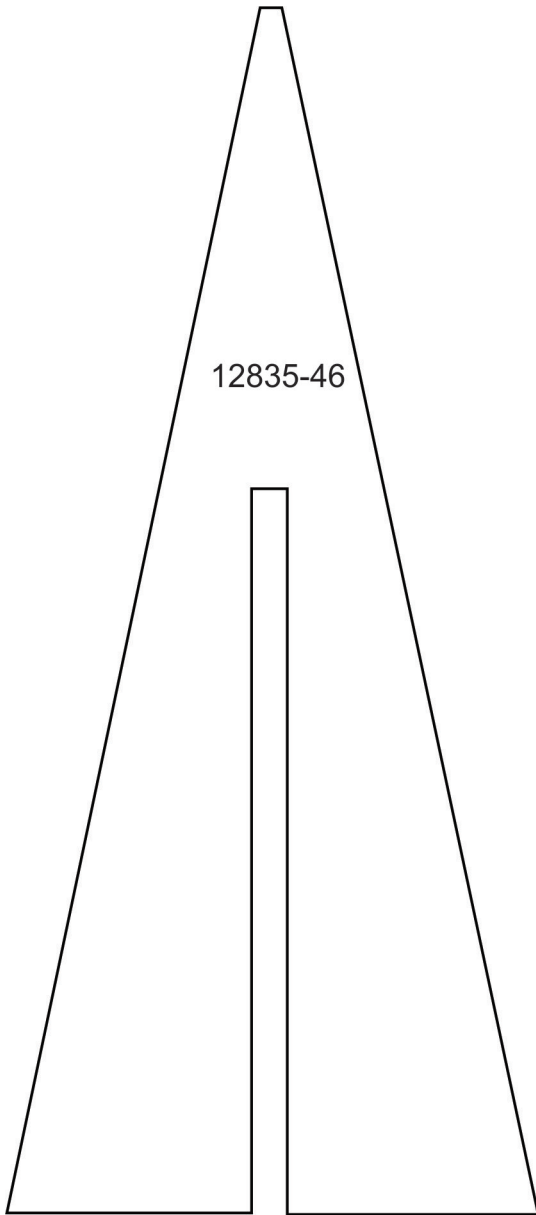

MIRRORED PATTERNS

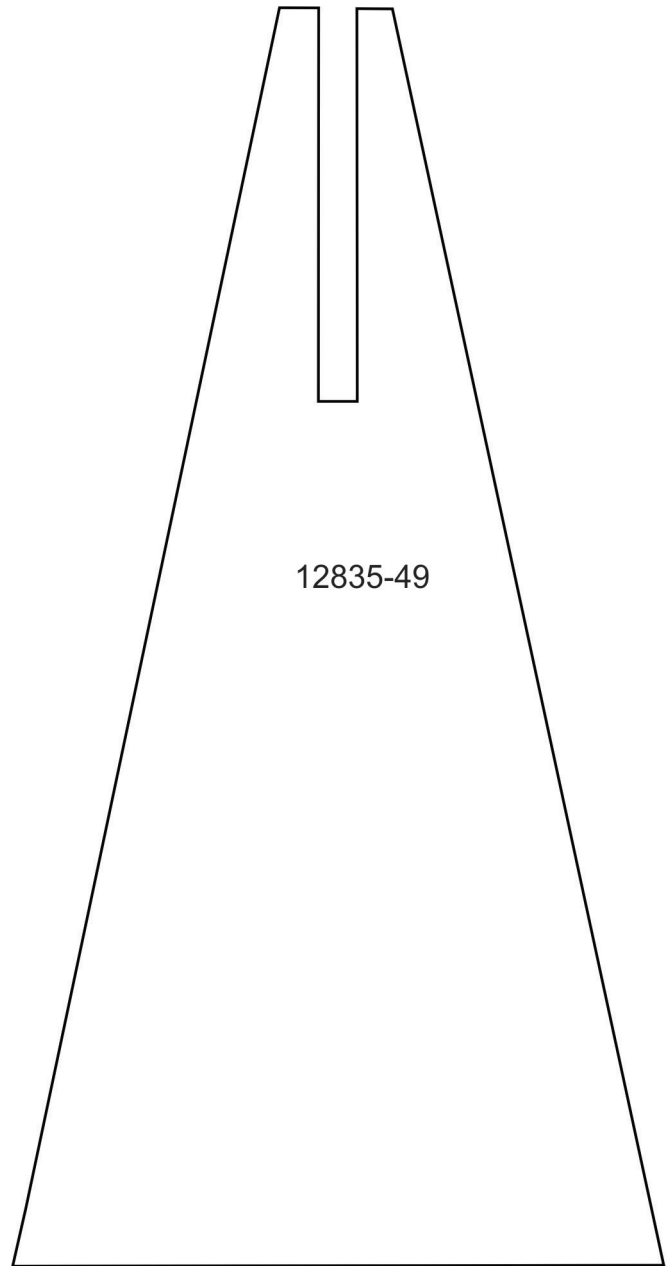
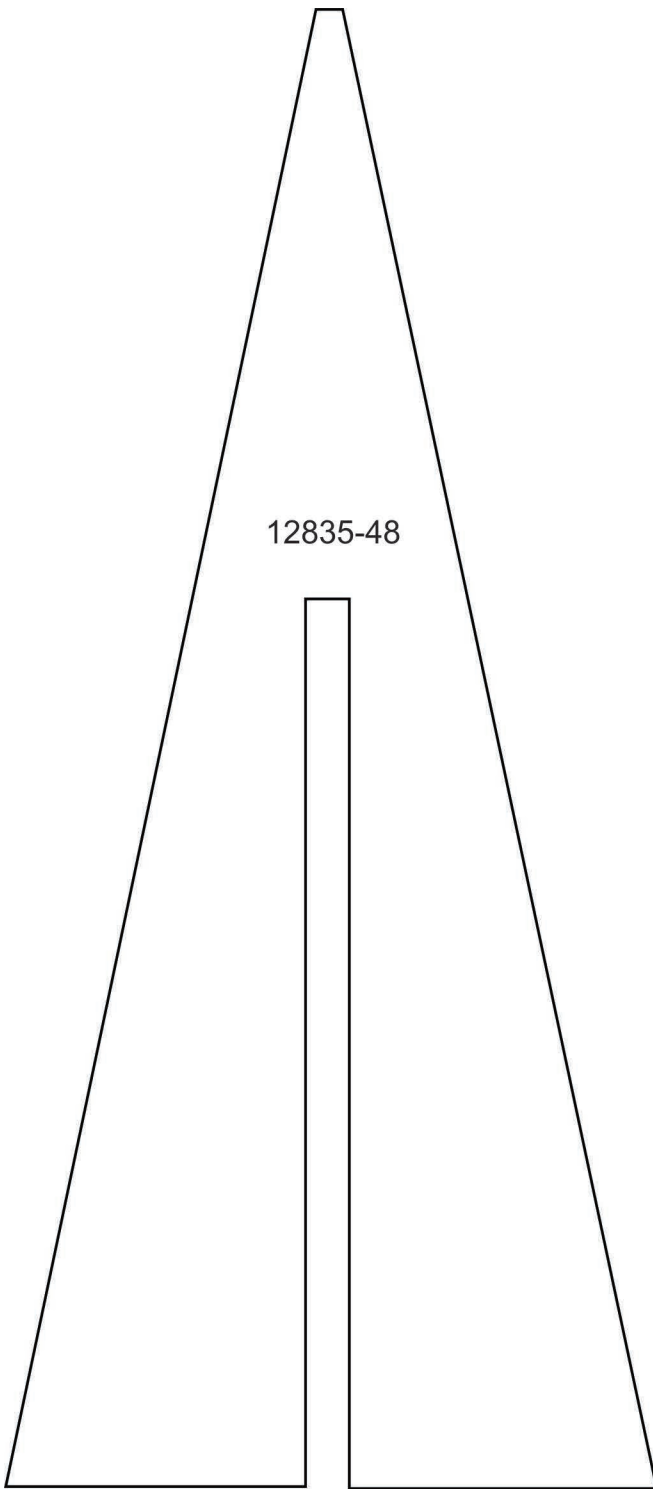

MIRRORED PATTERNS

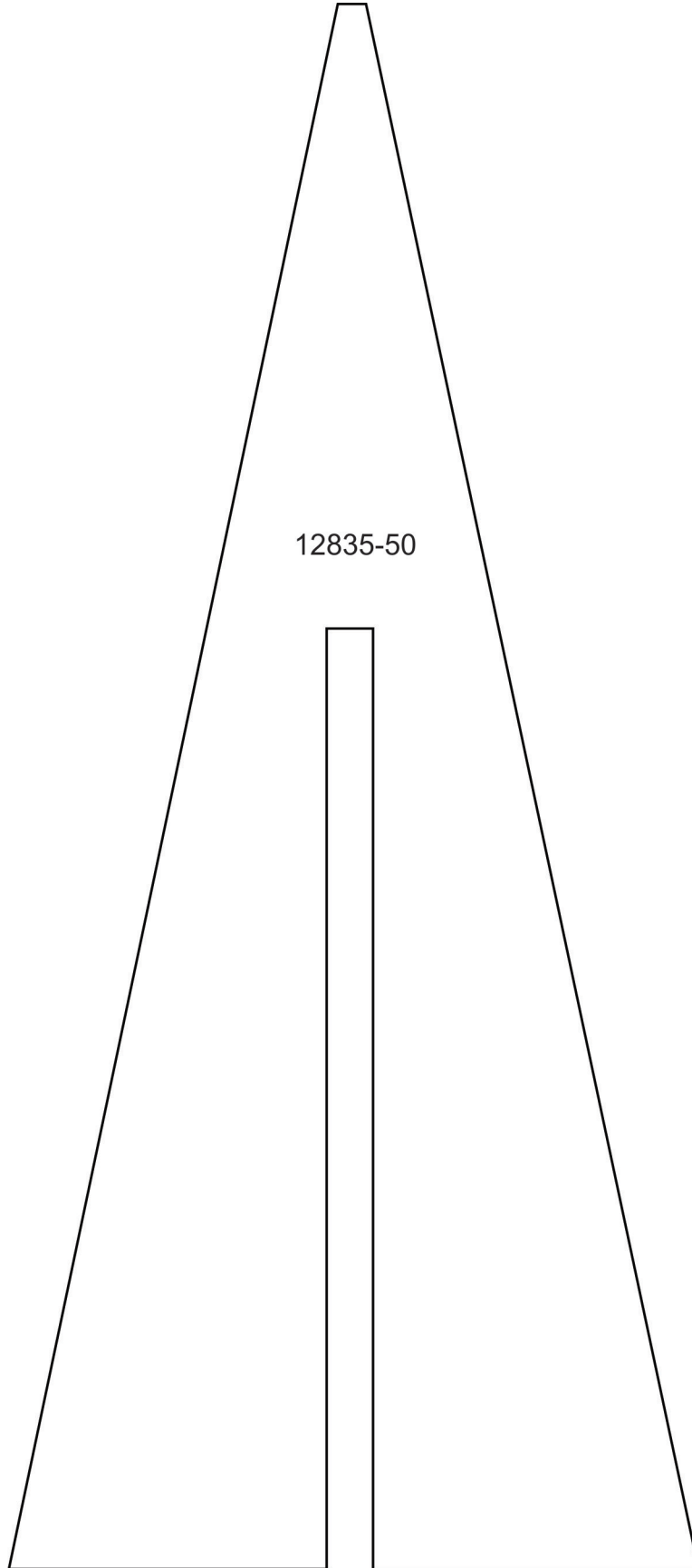

MIRRORED PATTERNS

