



**FREESTANDING  
Train Station**



**1**

**Design**

**Fits hoop sizes 6" x 10" and larger**

# THREAD LIST



## Isacord Thread Colors

### White Version

0015 White (3 spools)

### Color Version

1172 Ivory (3 spools)

**\* Project instructions included after design list.**

**Note: One spool of 1000 meter thread is adequate for the project unless otherwise noted.**

# DESIGNS

Note: Some designs in this collection may have been created using unique special stitches and/or techniques. To preserve design integrity when rescaling or rotating designs in your software, always rescale or rotate designs using the handles directly on-screen.

**\*Fabric Required**



### 12857-01 Front Door Wall FSA

Size Inches:                      Size mm:                      Stitch Count:  
**5.26 X 3.91 in.    133.6 X 99.3 mm    36576 St.**

- 1. Fabric Placement Stitch ..... 0015
- 2. Cut Line and Tackdown ..... 0015
- 3. Fabric Placement Stitch ..... 0015
- 4. Cut Line and Tackdown ..... 0015
- 5. Fabric Placement Stitch ..... 0015
- 6. Cut Line and Tackdown ..... 0015
- 7. Lace and Cover Stitch ..... 0015

Note: Some designs in this collection may have been created using unique special stitches and/or techniques. To preserve design integrity when rescaling or rotating designs in your software, always rescale or rotate designs using the handles directly on-screen.

**\*Fabric Required**

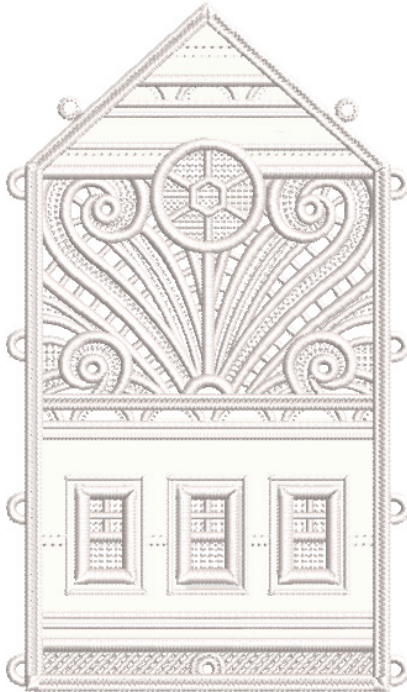

### 12857-02 Right Wall FSA

Size Inches:                      Size mm:                      Stitch Count:  
**6.55 X 3.82 in.    166.4 X 97.0 mm    39731 St.**

- 1. Fabric Placement Stitch ..... 0015
- 2. Cut Line and Tackdown ..... 0015
- 3. Fabric Placement Stitch ..... 0015
- 4. Cut Line and Tackdown ..... 0015
- 5. Lace and Cover Stitch ..... 0015

**\*Fabric Required**

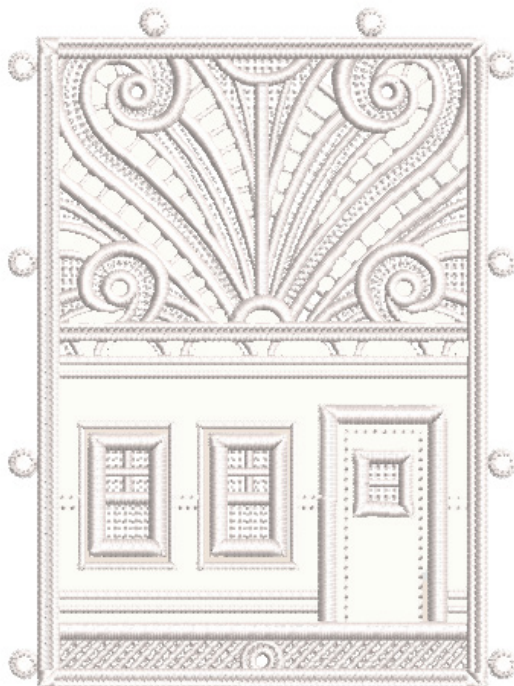

### 12857-03 Back Door Wall FSA

Size Inches:                      Size mm:                      Stitch Count:  
**5.26 X 3.91 in.    133.6 X 99.3 mm    36113 St.**

- 1. Fabric Placement Stitch ..... 0015
- 2. Cut Line and Tackdown ..... 0015
- 3. Fabric Placement Stitch ..... 0015
- 4. Cut Line and Tackdown ..... 0015
- 5. Gold Lace and Cover Stitch ..... 0015

Note: Some designs in this collection may have been created using unique special stitches and/or techniques. To preserve design integrity when rescaling or rotating designs in your software, always rescale or rotate designs using the handles directly on-screen.

**\*Fabric Required**

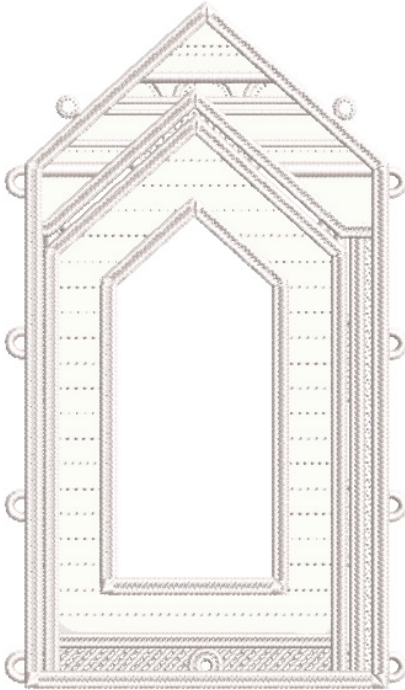

### 12857-04 Inner Wall FSA

Size Inches:                      Size mm:                      Stitch Count:  
**6.55 X 3.82 in.    166.4 X 97.0 mm    27939 St.**

- 1. Fabric Placement Stitch ..... 0015
- 2. Cut Line and Tackdown ..... 0015
- 3. Fabric Placement Stitch ..... 0015
- 4. Cut Line and Tackdown ..... 0015
- 5. Lace and Cover Stitch ..... 0015

**\*Fabric Required**

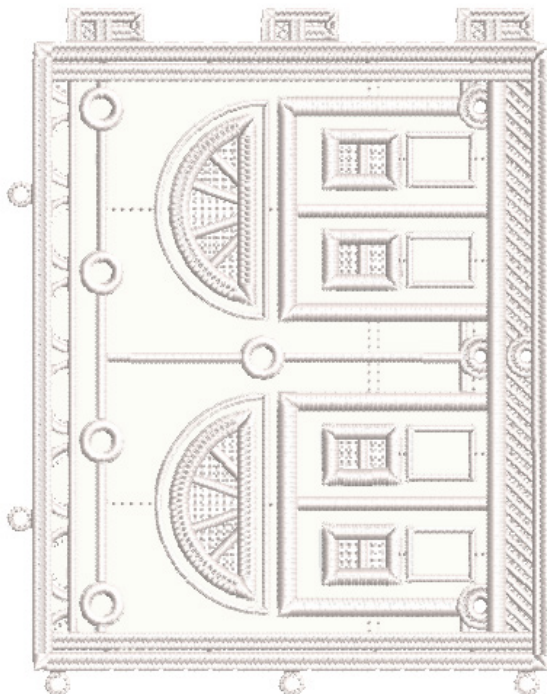

### 12857-05 Boarding Doors Wall FSA

Size Inches:                      Size mm:                      Stitch Count:  
**5.58 X 4.39 in.    141.7 X 111.5 mm    38253 St.**

- 1. Fabric Placement Stitch ..... 0015
- 2. Cut Line and Tackdown ..... 0015
- 3. Fabric Placement Stitch ..... 0015
- 4. Cut Line and Tackdown ..... 0015
- 5. Fabric Placement Stitch ..... 0015
- 6. Cut Line and Tackdown ..... 0015
- 7. Lace and Cover Stitch ..... 0015

Note: Some designs in this collection may have been created using unique special stitches and/or techniques. To preserve design integrity when rescaling or rotating designs in your software, always rescale or rotate designs using the handles directly on-screen.

**\*Fabric Required**

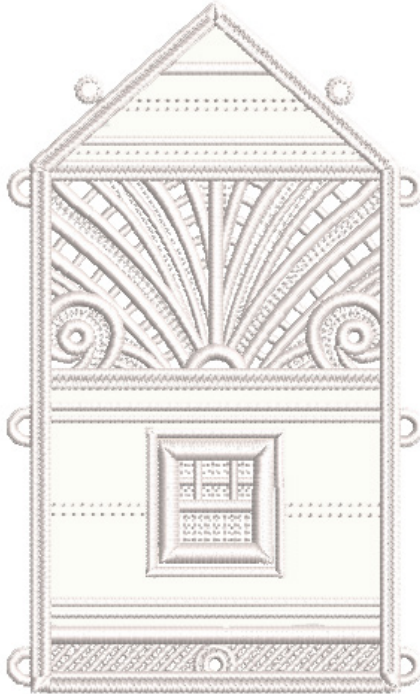

**12857-06 Left Wall FSA**

Size Inches:                      Size mm:                      Stitch Count:  
**5.46 X 3.28 in.    138.7 X 83.3 mm    26839 St.**

- 1. Fabric Placement Stitch ..... 0015
- 2. Cut Line and Tackdown ..... 0015
- 3. Fabric Placement Stitch ..... 0015
- 4. Cut Line and Tackdown ..... 0015
- 5. Lace and Cover Stitch ..... 0015

**\*Fabric Required**

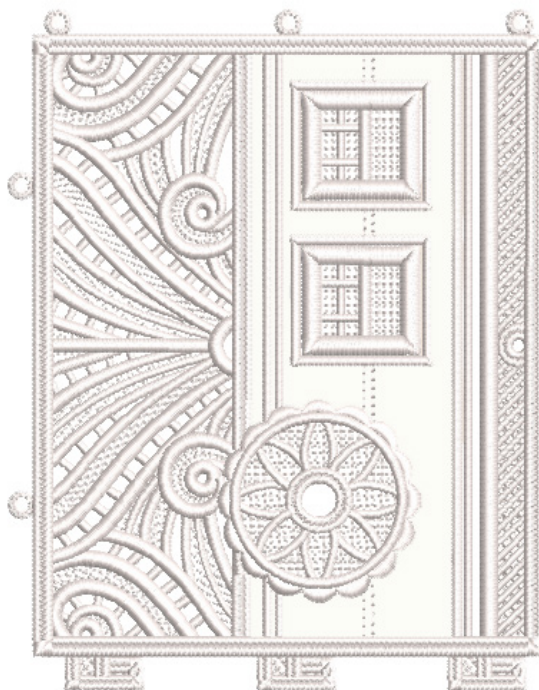

**12857-07 Back Wall FSA**

Size Inches:                      Size mm:                      Stitch Count:  
**5.59 X 4.39 in.    142.0 X 111.5 mm    45902 St.**

- 1. Fabric Placement Stitch ..... 0015
- 2. Cut Line and Tackdown ..... 0015
- 3. Lace and Cover Stitch ..... 0015

Note: Some designs in this collection may have been created using unique special stitches and/or techniques. To preserve design integrity when rescaling or rotating designs in your software, always rescale or rotate designs using the handles directly on-screen.

**\*Fabric Required**

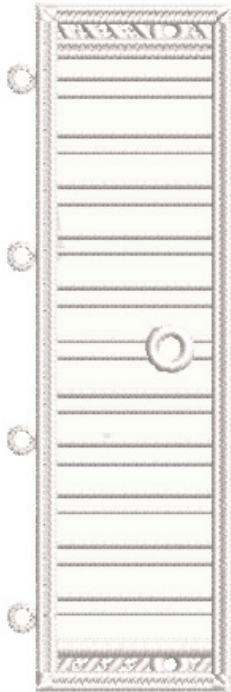

**12857-08 Overhang Roof FSA**

Size Inches:                      Size mm:                      Stitch Count:  
**5.11 X 1.68 in.    129.8 X 42.7 mm    10874 St.**

- 1. Fabric Placement Stitch ..... 0015
- 2. Cut Line and Tackdown ..... 0015
- 3. Lace and Cover Stitch ..... 0015

**12857-09 Overhang Pillars FSL**

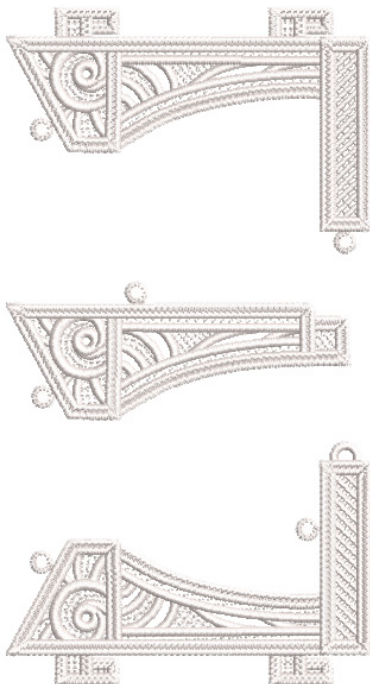

Size Inches:                      Size mm:                      Stitch Count:  
**6.70 X 3.60 in.    170.2 X 91.4 mm    26731 St.**

- 1. Single Color Design..... 0015

Note: Some designs in this collection may have been created using unique special stitches and/or techniques. To preserve design integrity when rescaling or rotating designs in your software, always rescale or rotate designs using the handles directly on-screen.

**\*Fabric Required**

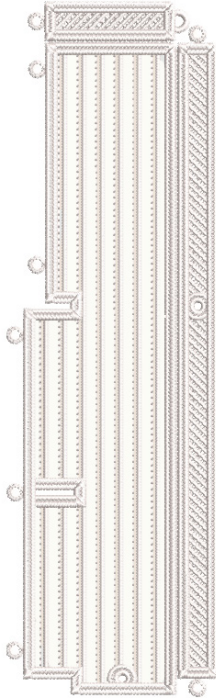

**12857-10 Front Platform FSA**

Size Inches:	Size mm:	Stitch Count:
<b>8.89 X 2.70 in.</b>	<b>225.8 X 68.6 mm</b>	<b>39322 St.</b>

- 1. Fabric Placement Stitch ..... 0015
- 2. Cut Line and Tackdown ..... 0015
- 3. Lace and Cover Sttich ..... 0015

**\*Fabric Required**

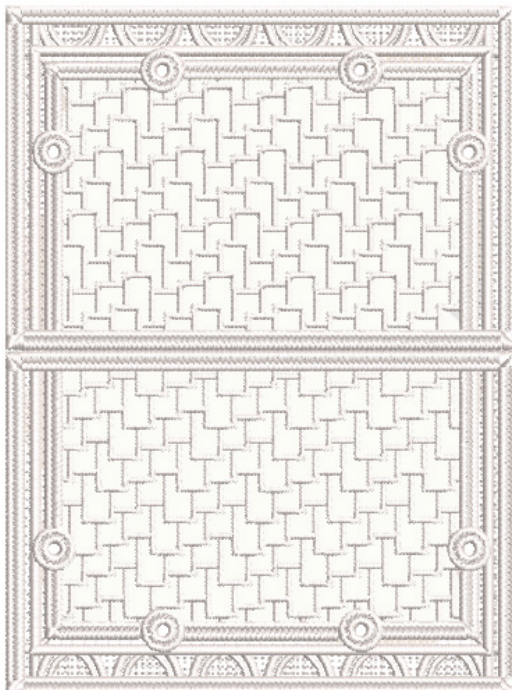

**12857-11 Right Roof FSA**

Size Inches:	Size mm:	Stitch Count:
<b>5.82 X 4.29 in.</b>	<b>147.8 X 109.0 mm</b>	<b>45105 St.</b>

- 1. Fabric Placement Stitch ..... 0015
- 2. Cut Line and Tackdown ..... 0015
- 3. Fabric Placement Stitch ..... 0015
- 4. Cut Line and Tackdown ..... 0015
- 5. Lace and Cover Stitch ..... 0015

Note: Some designs in this collection may have been created using unique special stitches and/or techniques. To preserve design integrity when rescaling or rotating designs in your software, always rescale or rotate designs using the handles directly on-screen.

**\*Fabric Required**

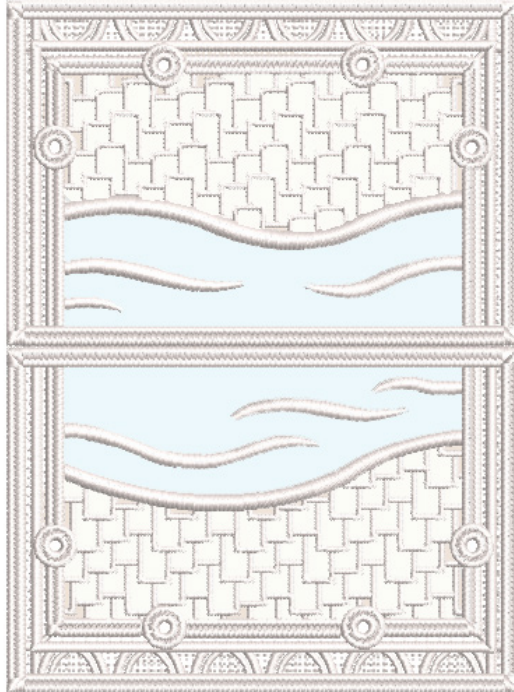

### 12857-12 Right Roof with Snow FSA

Size Inches:                      Size mm:                      Stitch Count:  
**5.82 X 4.29 in.    147.8 X 109.0 mm    40765 St.**

- 1. Fabric Placement Stitch ..... 0015
- 2. Cut Line and Tackdown ..... 0015
- 3. Fabric Placement Stitch ..... 0015
- 4. Cut Line and Tackdown ..... 0015
- 5. Fabric Placement Stitch ..... 0015
- 6. Cut Line and Tackdown ..... 0015
- 7. Fabric Placement Stitch ..... 0015
- 8. Cut Line and Tackdown ..... 0015
- 9. Lace and Cover Stitch ..... 0015

**\*Fabric Required**

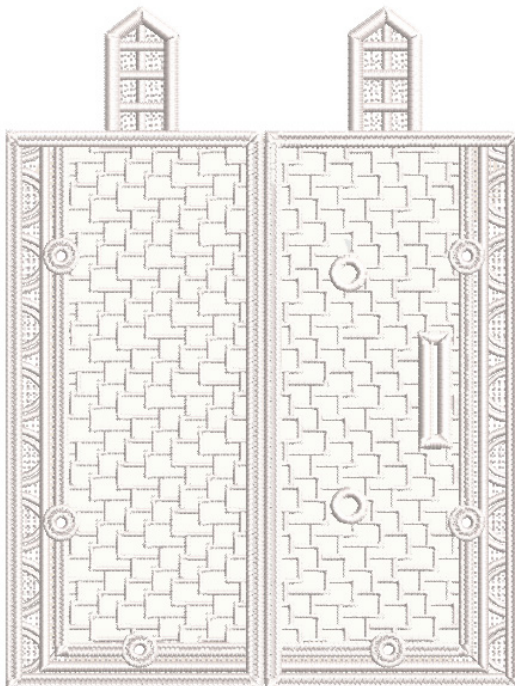

### 12857-13 Left Roof FSA

Size Inches:                      Size mm:                      Stitch Count:  
**6.72 X 5.04 in.    170.7 X 128.0 mm    49763 St.**

- 1. Fabric Placement Stitch ..... 0015
- 2. Cut Line and Tackdown ..... 0015
- 3. Fabric Placement Stitch ..... 0015
- 4. Cut Line and Tackdown ..... 0015
- 5. Lace and Cover Stitch ..... 0015



Note: Some designs in this collection may have been created using unique special stitches and/or techniques. To preserve design integrity when rescaling or rotating designs in your software, always rescale or rotate designs using the handles directly on-screen.

**\*Fabric Required**

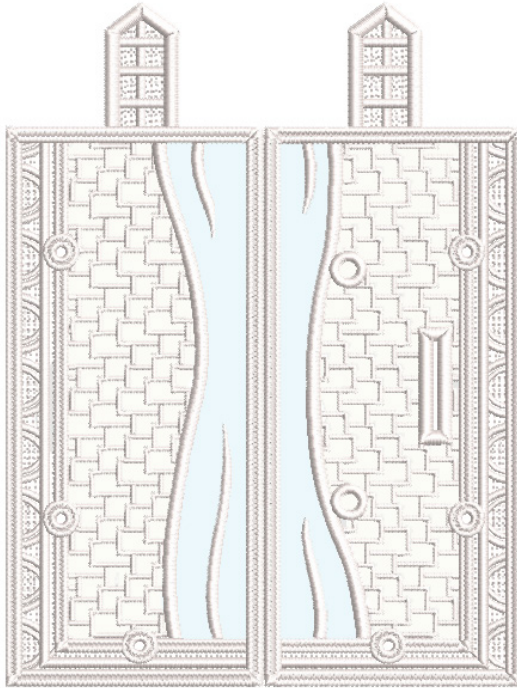

### 12857-14 Left Roof with Snow FSA

Size Inches:                      Size mm:                      Stitch Count:  
**6.72 X 5.04 in.**    **170.7 X 128.0 mm**    **47122 St.**

- 1. Fabric Placement Stitch ..... 0015
- 2. Cut Line and Tackdown ..... 0015
- 3. Fabric Placement Stitch ..... 0015
- 4. Cut Line and Tackdown ..... 0015
- 5. Fabric Placement Stitch ..... 0015
- 6. Cut Line and Tackdown ..... 0015
- 7. Fabric Placement Stitch ..... 0015
- 8. Cut Line and Tackdown ..... 0015
- 9. Lace and Cover Stitch ..... 0015

**\*Fabric Required**



### 12857-15 Clock FSA

Size Inches:                      Size mm:                      Stitch Count:  
**2.96 X 3.97 in.**    **75.2 X 100.8 mm**    **8361 St.**

- 1. White Fabric Placement Stitch ..... 0015
- 2. Cut Line and Tackdown ..... 0015
- 3. Lace and Cover Stitch ..... 0015

Note: Some designs in this collection may have been created using unique special stitches and/or techniques. To preserve design integrity when rescaling or rotating designs in your software, always rescale or rotate designs using the handles directly on-screen.

**\*Fabric Required**

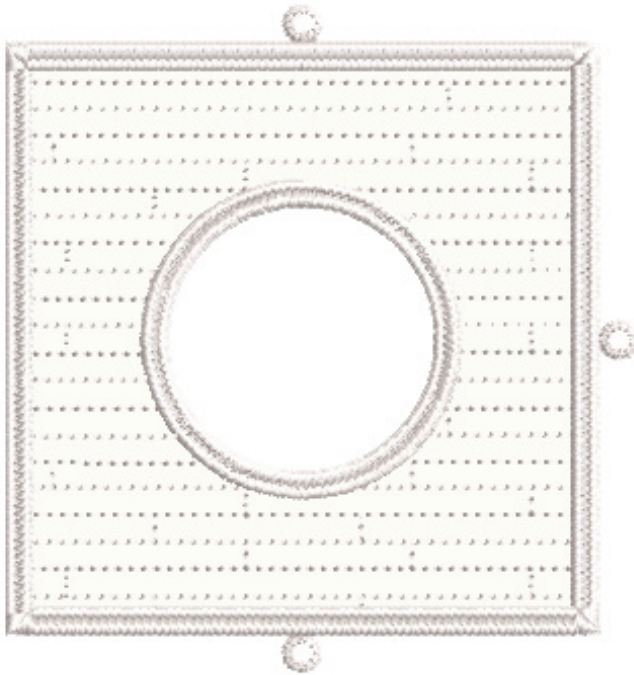

### 12857-16 Right Foundation FSA

Size Inches:	Size mm:	Stitch Count:
<b>3.88 X 3.65 in.</b>	<b>98.6 X 92.7 mm</b>	<b>8819 St.</b>

- 1. White Fabric Placement Stitch ..... 0015
- 2. Cut Line and Tackdown ..... 0015
- 3. Lace and Cover Stitch ..... 0015

**\*Fabric Required**

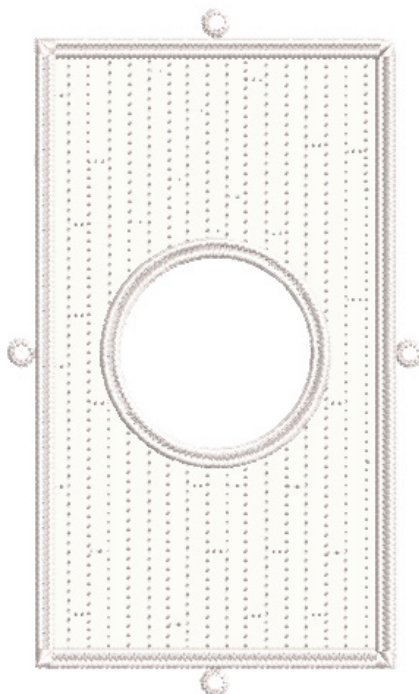

### 12857-17 Left Foundation FSA

Size Inches:	Size mm:	Stitch Count:
<b>5.51 X 3.32 in.</b>	<b>140.0 X 84.3 mm</b>	<b>10515 St.</b>

- 1. Fabric Placement Stitch ..... 0015
- 2. Cut Line and Tackdown ..... 0015
- 3. Lace and Cover Stitch ..... 0015

## Stabilizers

- OESD WashAway AquaMesh
- OESD WashAway BadgeMaster
- OESD StabilStick CutAway

## Fabrics/Textiles

- White cotton fabric ½ yard
- Note: Fabric sizes are estimates and may result in overage.

## Notions & Tools

- OESD Alligator Clamps
- OESD Button Clips
- OESD Expert Embroidery Tape WashAway
- OESD Perfect Embroidery Press Cloth
- OESD Perfect Point and Press Tool
- Utility knife
- Embroidery Needle Sharp 75/11

## Isacord Thread Colors

- Per thread chart
- Match bobbin thread to top thread
- 0015 White (3 spools)

# SUMMARY



Completed Size: 7.5" H x 5" W x 7" D

12857-01



Requires 1 Design

12857-02



Requires 1 Design

12857-03

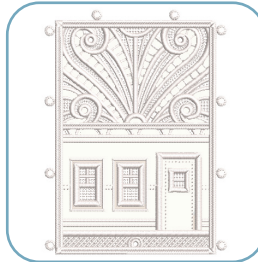

Requires 1 Design

12857-04

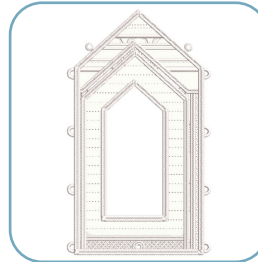

Requires 1 Design

12857-05

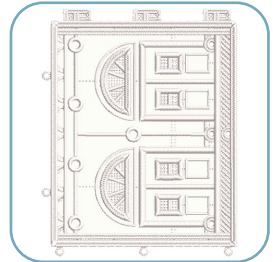

Requires 1 Design

12857-06

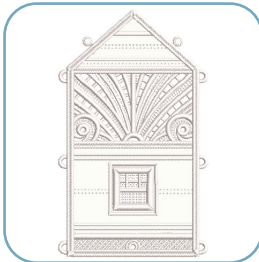

Requires 1 Design

12857-07



Requires 1 Design

12857-08

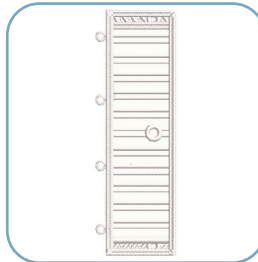

Requires 1 Design

12857-09

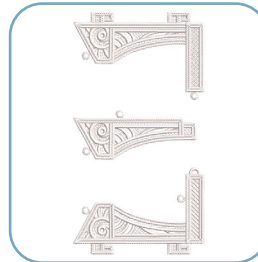

Requires 1 Design

12857-10

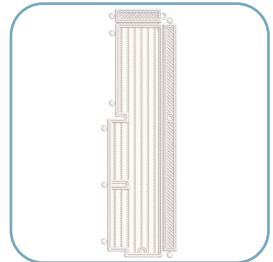

Requires 1 Design

12857-11

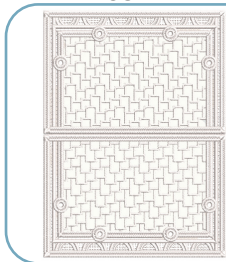

12857-12

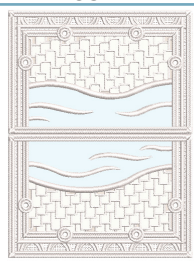

or

Requires 1 Design

12857-13

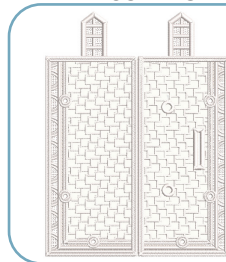

12857-14

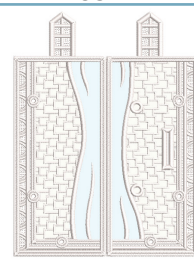

or

Requires 1 Design

12857-15



Requires 1 Design

12857-16

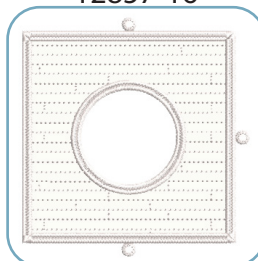

Requires 1 Design

12857-17

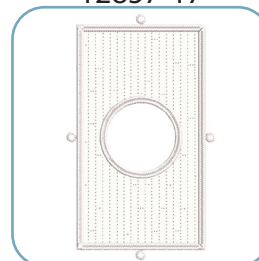

Requires 1 Design

It is a violation of Copyright law to make and distribute copies of electronic designs or artwork. Electronic designs are licensed to the original purchaser for use at one location. ©2021 OESD, LLC. All rights reserved.

## NOTE

The freestanding applique instructions, included in the collection, are general instructions. For demonstration purposes, a sample design that best demonstrates the technique is shown. Fabric and thread requirements will vary by design, but the general technique is the same.

All designs are stitched with matching thread, top and bobbin.

For other designs in the collection, use the applique templates as a guide to the dimensions of the various applique pieces.

Note: Some thread colors in instructions have been changed or digitally enhanced for better visibility.

## STEP 1

- Hoop one layer of AquaMesh and one layer of BadgeMaster for all designs.



## STEP 2

- Adhere two layers of StabilStick CutAway to the wrong side of all applique fabrics to provide stiffness to the finished structure.
- Cut the prepared applique fabrics 1/4"-1/2" larger than the templates.

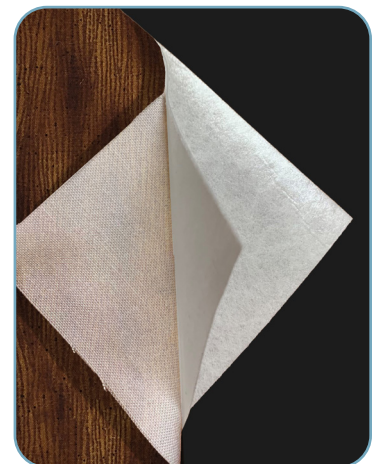

# EMBROIDERY



## STEP 3

- Load selected design into the machine.
- Example design is Front Door Wall FSA (12857-01).
- Thread the machine per the thread chart.
- Place hoop on the machine.
- Stitch Machine Step 1, Placement Stitch.

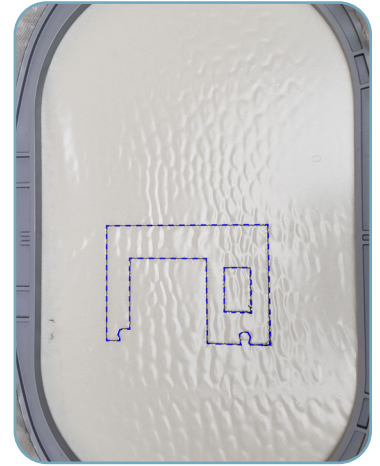

## STEP 4

- Remove the hoop from the machine, but NOT the project from the hoop.
- Place the hoop on a flat surface.
- Place the prepared applique fabric, right side up, completely covering the placement stitch.
- Tape in place to secure.



## STEP 5

- Return the hoop to the machine.
- Stitch Machine Step 2, Cut Line and Tackdown.

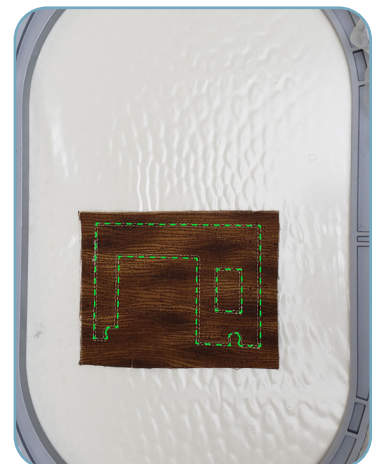

## STEP 6

- Remove the hoop from the machine, but NOT the project from the hoop.
- Trim the excess fabric as close to the cut line as possible.
- Note: If the outermost row of stitching (cut line) is accidentally cut, the inner stitches (tackdown) will hold the applique in place.
- Tip: If the OESD AquaMesh is cut or a hole is created while trimming the fabric, use OESD Expert Embroidery Tape WashAway as a patch.



## STEP 7

- Return the hoop to the machine.
- Stitch Machine Step 3, Fabric Placement Stitch.



## STEP 8

- Remove the hoop from the machine, but NOT the project from the hoop.
- Place the hoop on a flat surface.
- Place the prepared applique fabric, right side up, completely covering the placement stitch.
- Tape in place to secure.
- Return the hoop to the machine.
- Stitch Machine Step 4, Cut Line and Tackdown.
- Remove the hoop from the machine, but NOT the project from the hoop.
- Trim the excess fabric as close to the cut line stitching as possible.



## STEP 9

- Return the hoop to the machine.
- Stitch Machine Step 5, Fabric Placement Stitch.
- Remove the hoop from the machine, but NOT the project from the hoop.
- Place the hoop on a flat surface.
- Place the prepared applique fabric, right side up, completely covering the placement stitch.
- Tape in place to secure.



## STEP 10

- Remove the hoop from the machine, but NOT the project from the hoop.
- Trim the excess fabric as close to the cut line stitching as possible.





# EMBROIDERY



## STEP 11

- Return the hoop to the machine.
- Stitch Machine Step 7, Lace and Cover Stitch.
- When design is complete, remove the project from the hoop and trim the stabilizer 1/4" - 1/2" outside the design.
- Rinse each piece in warm running water until the design is only slightly sticky.



## STEP 12

- Lay face down on a non-stick surface to dry. Parchment paper or a cooling rack work well. This prevents the piece from curling.
- Press each piece, right side down, on a Perfect Embroidery Press Cloth.

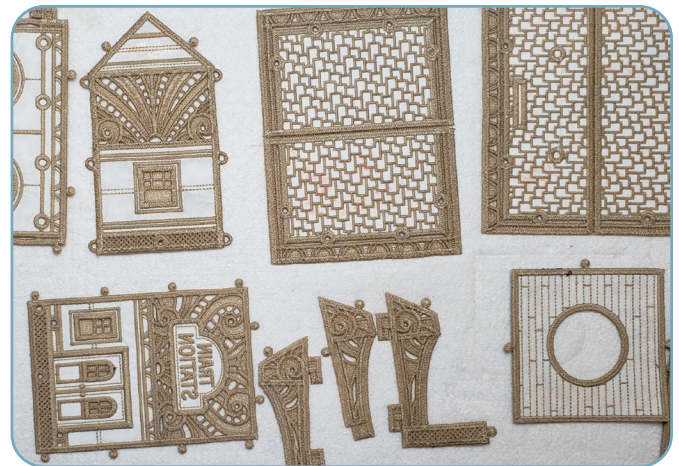

## STEP 13

- Use the punch tool, with the 3mm attachment, to punch holes in the eyelets indicated by red circles.
- Use a razor knife or scissors to cut a slit in the roof indicated by the dotted yellow line.
- Punch tool guide is located after instructions.

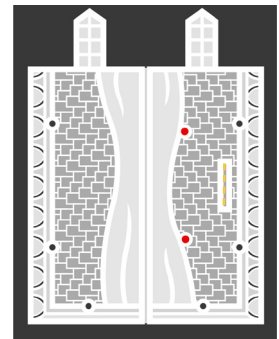
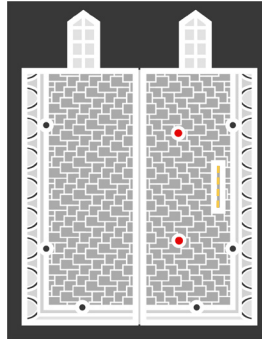
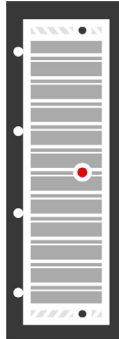

# ASSEMBLY



## STEP 14

- Using alligator clamps, attach Front Door FSA (12857-01), Right Wall FSA (12857-02), Back Door FSA (12857-03) and Inner Wall FSA (12857-04) by pulling the buttonettes through the corresponding eyelets on the adjacent piece as shown.

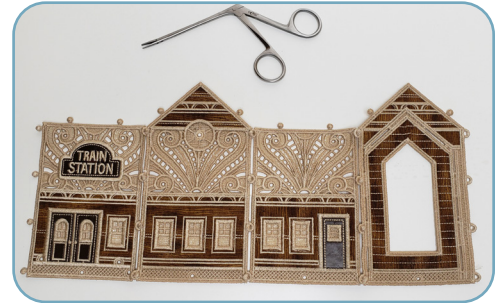

## STEP 15

- Attach Front Door FSA (12857-01) to Inner Wall FSA (12857-04) to create the structure.



## STEP 16

- Attach the Back Wall FSA (12857-07) to Left Wall FSA (12857-06). Attach the Left Wall FSA to the Boarding Doors Wall FSA (12857-05) by pulling buttonettes through the corresponding eyelets.



# ASSEMBLY



## STEP 17

- Attach the 4 buttonettes on Overhang Roof FSA (12857-08) to the eyelets on the Boarding Doors Wall FSA (12857-05).

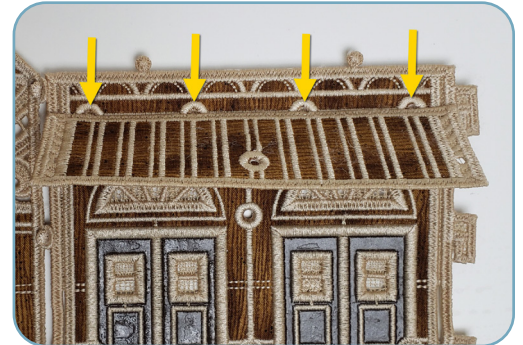

## STEP 18

- Attach one of the Overhang Pillars FSL (12857-09) to both Boarding Doors Wall FSA (12857-05) and Overhang Roof (12857-08) by sliding the tab through the tab entry.
- Attach the remaining Overhang Pillar supports to Boarding Doors Wall FSA by sliding the side tabs into the tab entry. Pull the top buttonettes of the Overhang Pillars FSL through the eyelets in Overhang Roof FSA.

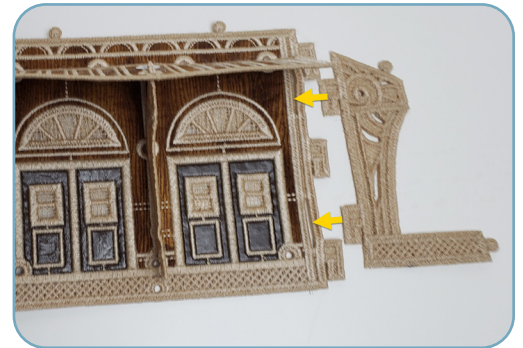

## STEP 19

- Attach the overhang to the main building by sliding the tab into the entry tabs to the left of the main building.
- Gently pull down to secure.



# ASSEMBLY



## STEP 20

- Creating the Platform. Fold at the hinge of the front and right side of Front Platform FSA (12857-10) and attach at the corner by inserting the buttonette into the corresponding eyelet.

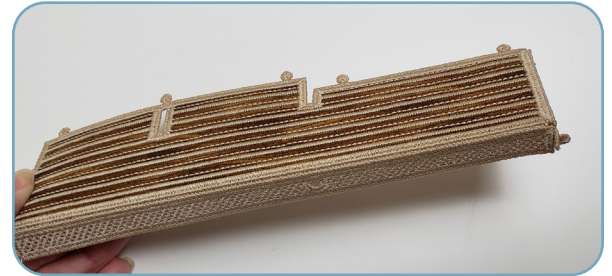

## STEP 21

- Attach the Front Platform FSA (12857-10) to the front of the building. Slide the Overhang Pillars FSL (12857-09) into the platform and pull the remaining buttonettes through the corresponding eyelets.



## STEP 22

- Attach the Clock FSA (12857-15) by pulling the tab through the Left Roof FSA (12857-13) or Left Roof with Snow FSA (12857-14).
- Attach the Clock and Roof to the overhang section of the station.
- Note: The train station comes with a choice of two roof options, one with snow and one without.



# ASSEMBLY



## STEP 23

- Attach the Right Roof FSA (12857-11) or Right Roof with Snow FSA (12857-12) to the main station building by pulling the buttonettes through the corresponding eyelets.



## STEP 24

- Attach the Right Foundation FSA (12857-16) and Left Foundation FSA (12857-17) to the base of the station by pulling the buttonettes into the corresponding eyelets.

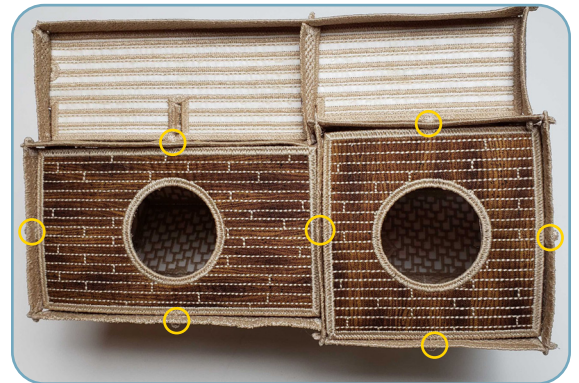

## FINISHING TOUCHES

- The train station is complete. Enjoy.
- Add tea lights or pixie lights to create a glow.

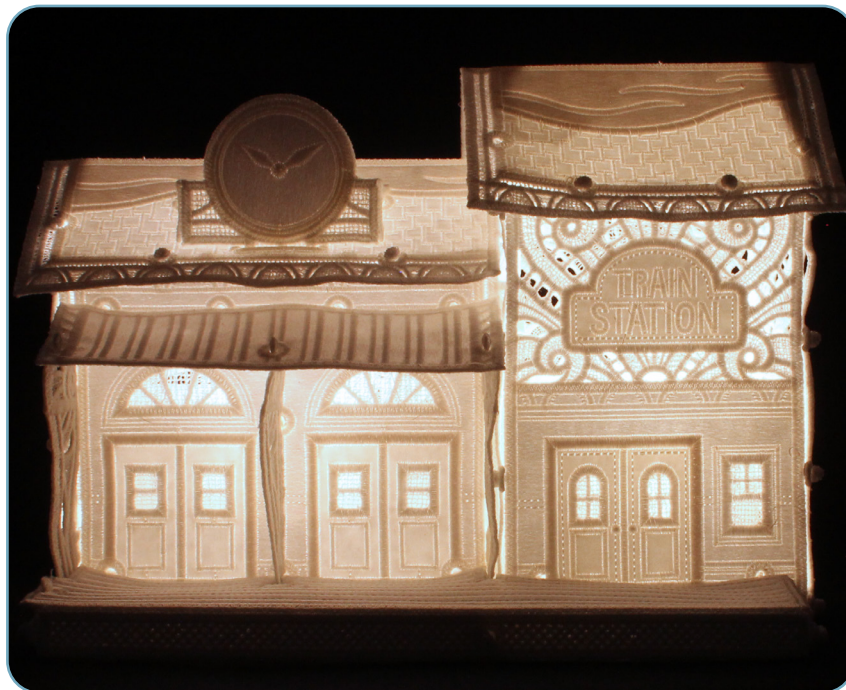

## ATTENTION

When printing this document, any page scaling or page fitting options in your print dialog box must be turned OFF or set to NONE so that your files will print out at their actual size. Images not printed at actual size will not function as intended.

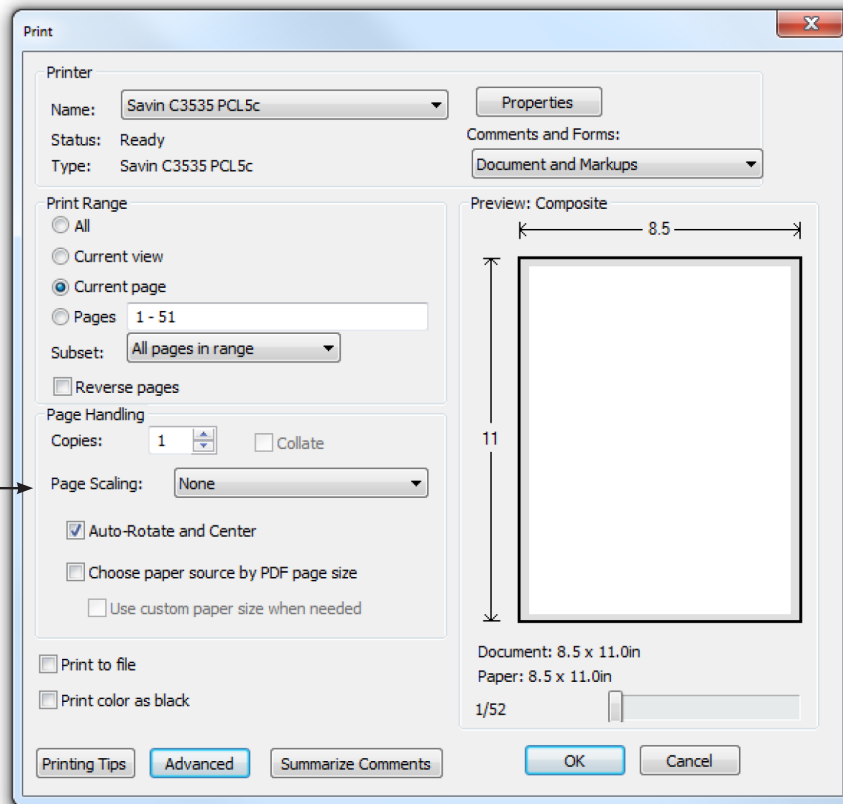

## TO SAVE PAPER

Only print the desired image by navigating to the image's page, go to File > Print and select "Current page" in the print dialog box. Repeat for each desired image.

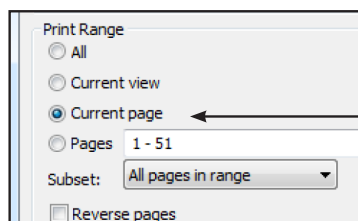



12857-05

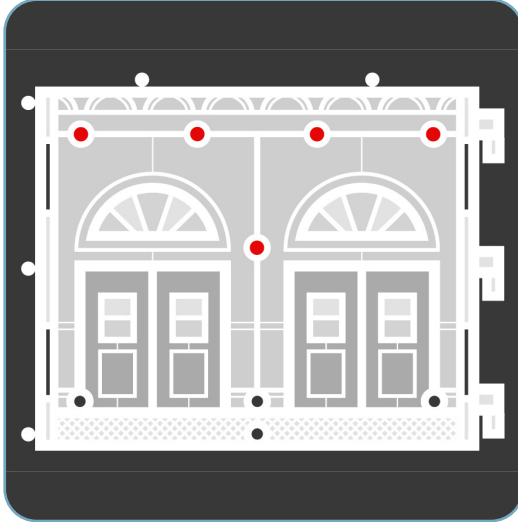

12857-08

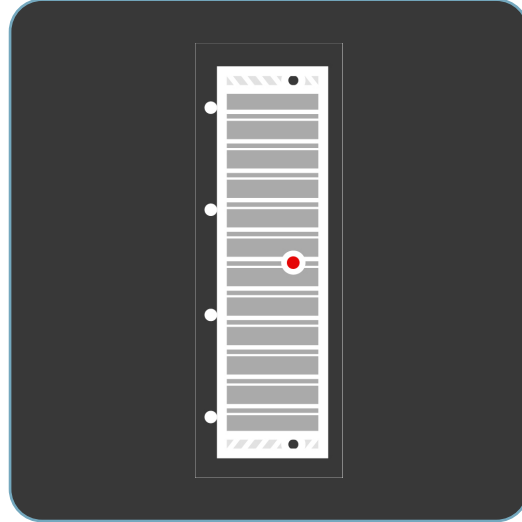

12857-13

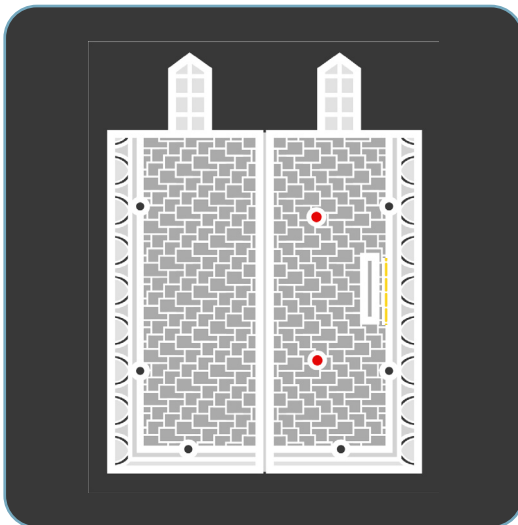

12857-14

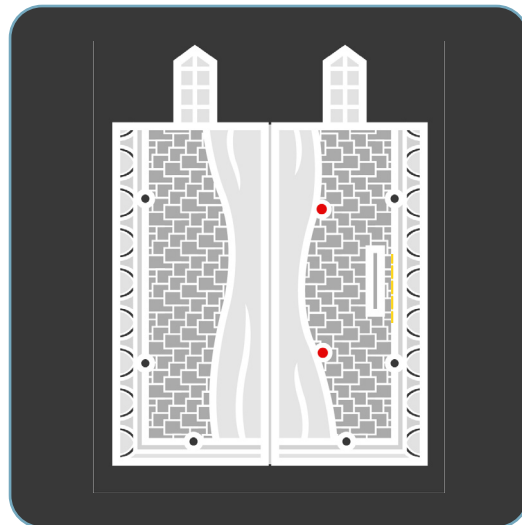

- = 2 MM
- = 3 MM
- = 4 MM

CRAFT KNIFE



# APPLIQUE PATTERNS



Print at 100%. No scaling. This box measures 1" x 1". Use the box as an accuracy guide when printing templates.

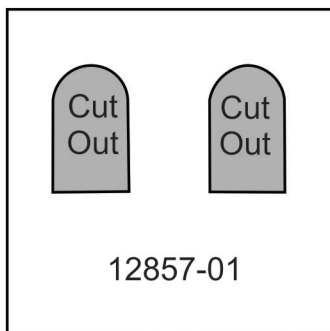
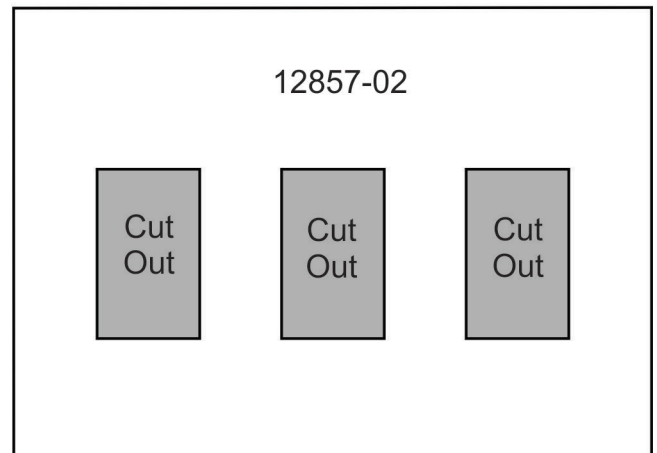
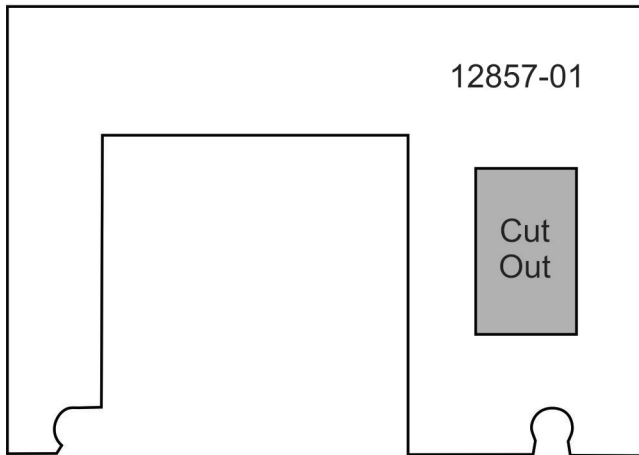
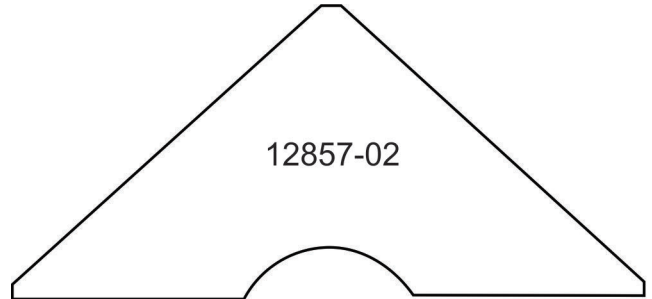
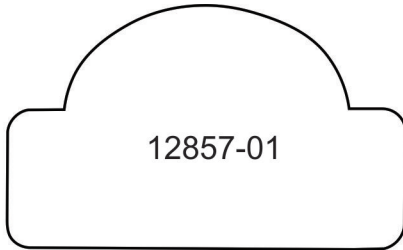

# APPLIQUE PATTERNS



Print at 100%. No scaling. This box measures 1" x 1". Use the box as an accuracy guide when printing templates.

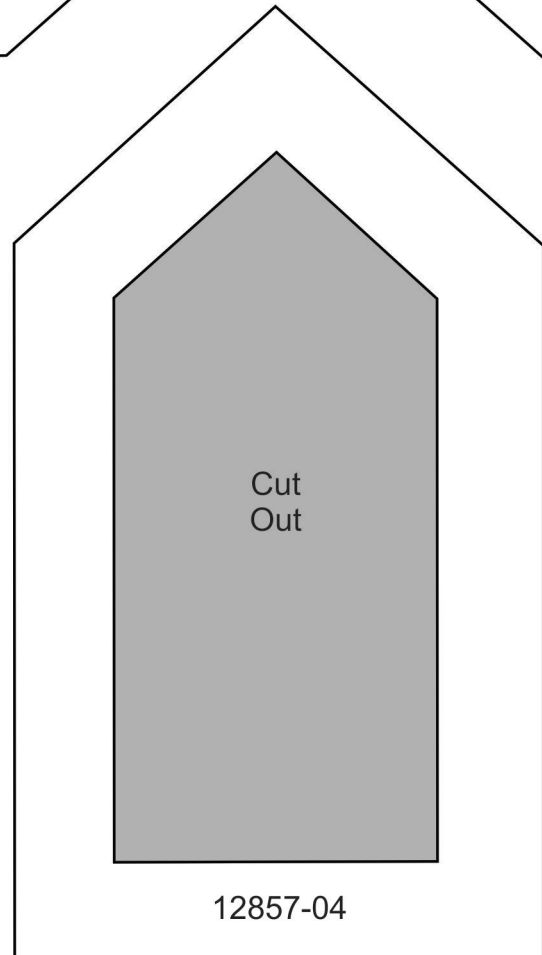
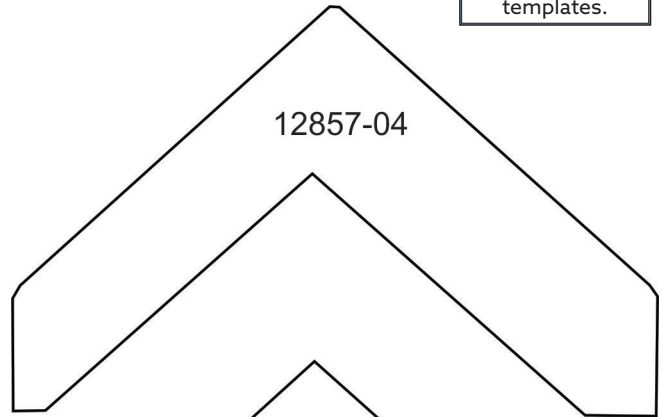
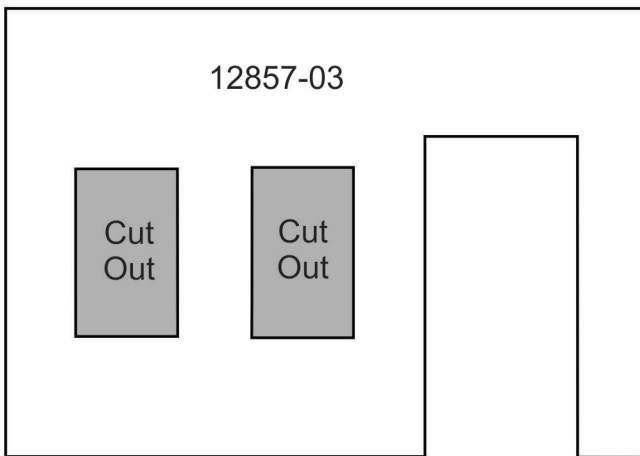
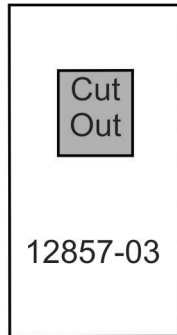

# APPLIQUE PATTERNS



Print at 100%. No scaling. This box measures 1" x 1". Use the box as an accuracy guide when printing templates.

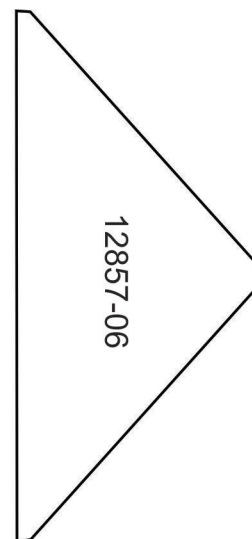
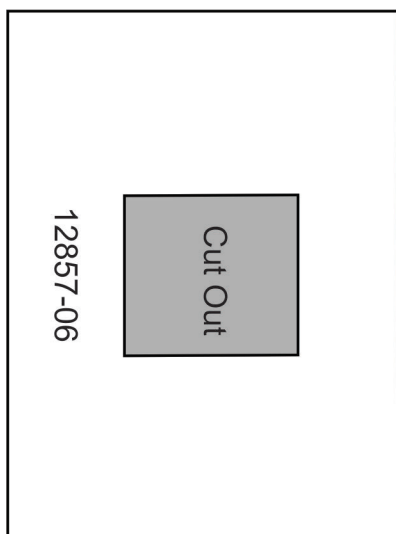
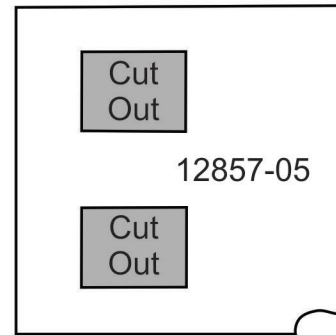
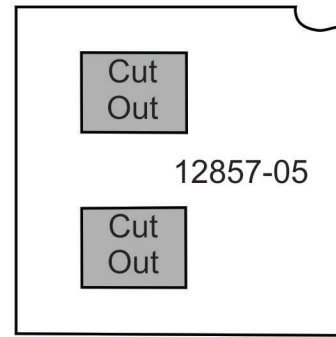
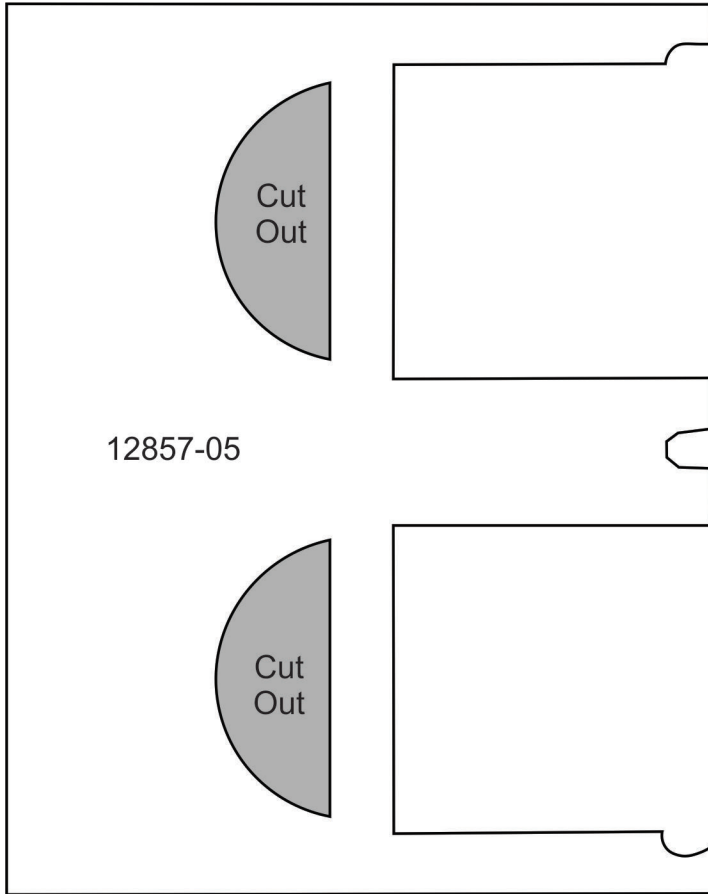

# APPLIQUE PATTERNS



Print at 100%. No scaling. This box measures 1" x 1". Use the box as an accuracy guide when printing templates.

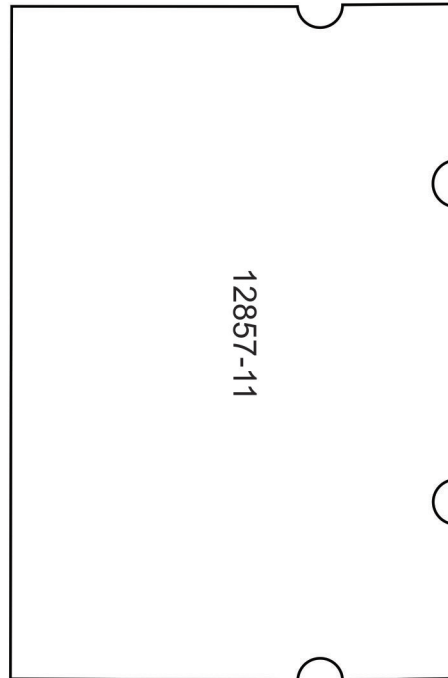
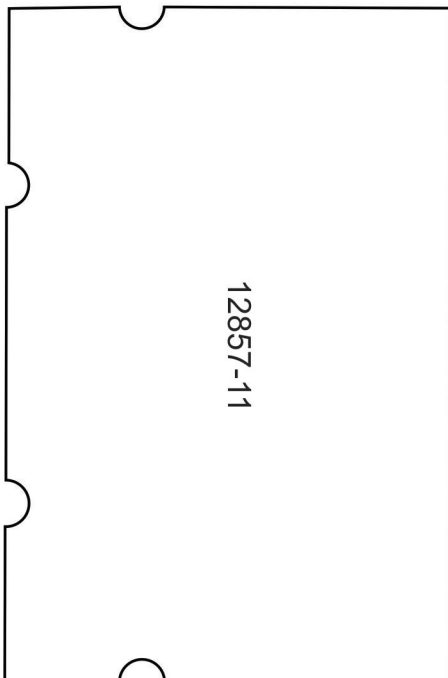
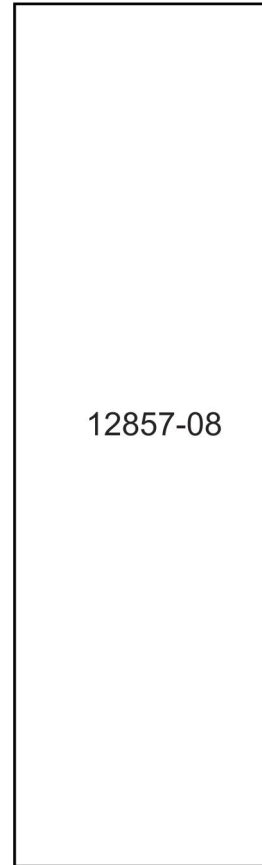
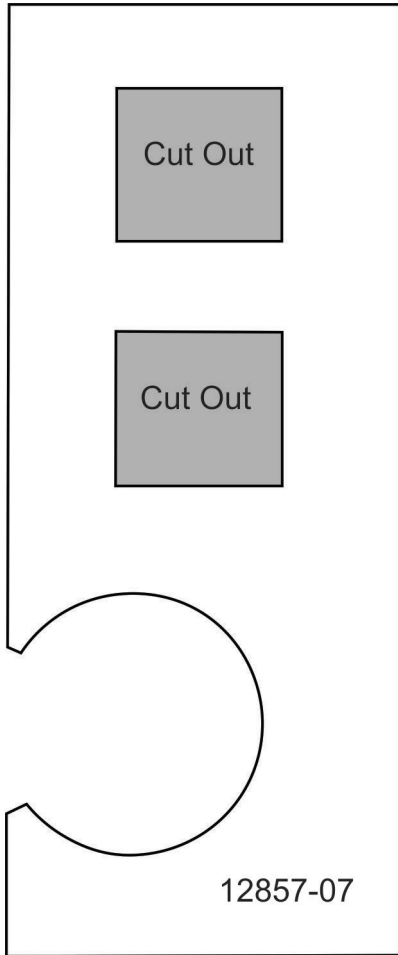

# APPLIQUE PATTERNS



Print at 100%. No scaling. This box measures 1" x 1". Use the box as an accuracy guide when printing templates.

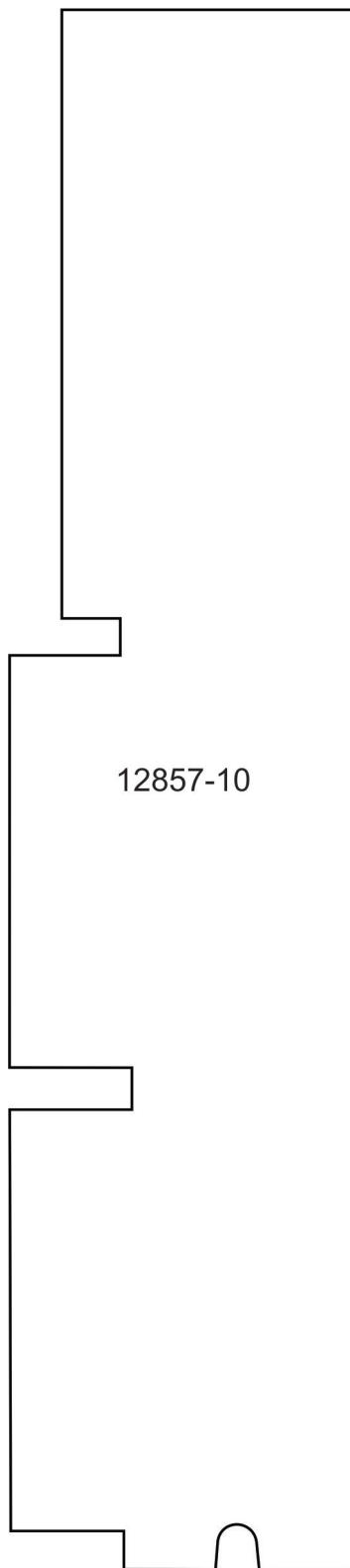
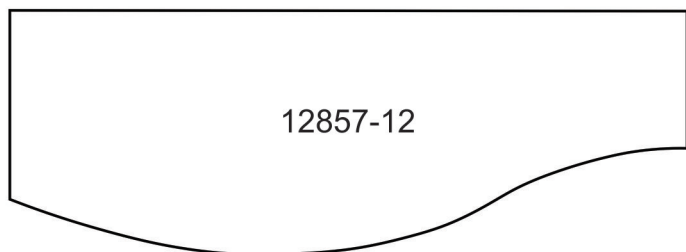
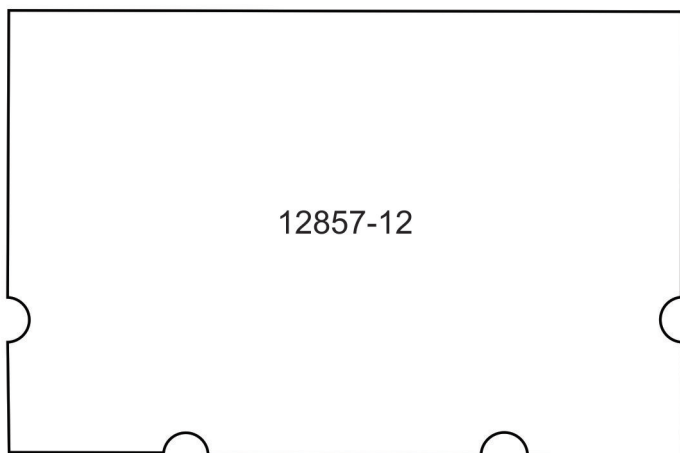
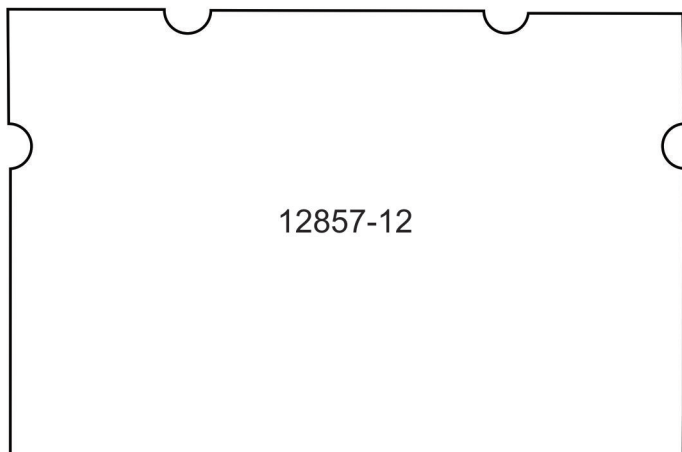
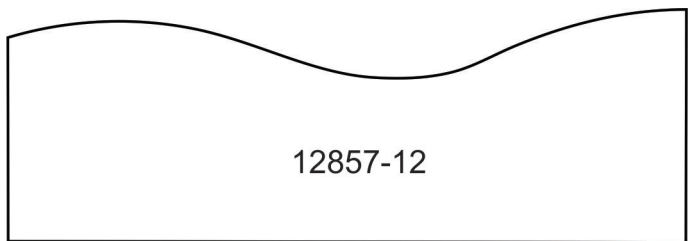

# APPLIQUE PATTERNS



Print at 100%. No scaling. This box measures 1" x 1". Use the box as an accuracy guide when printing templates.

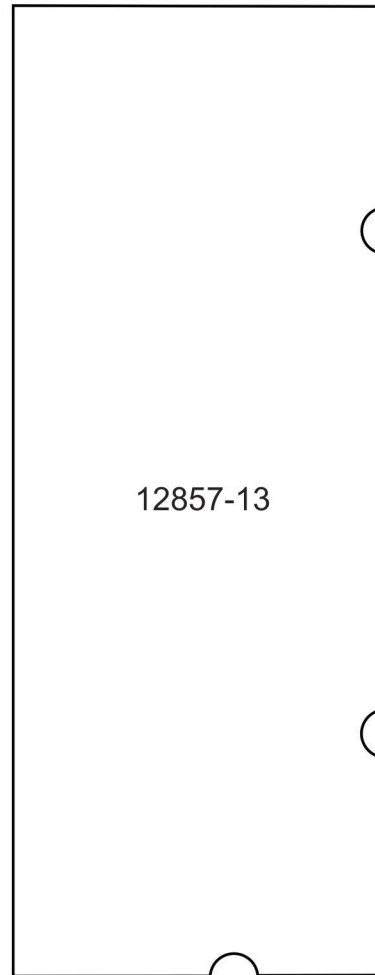
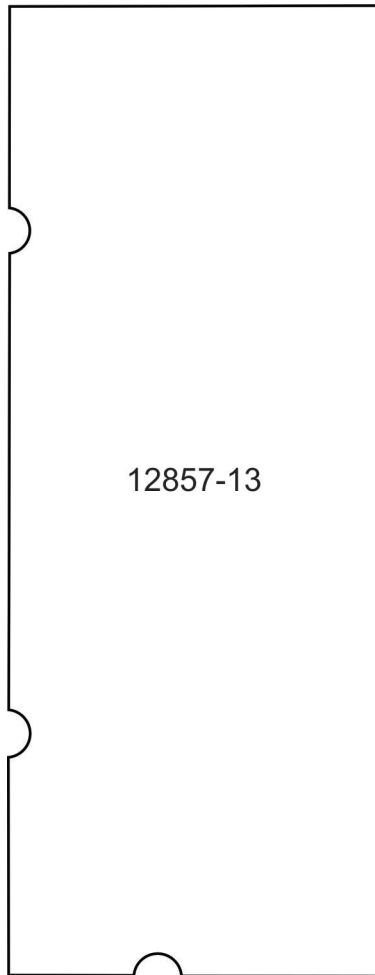

# APPLIQUE PATTERNS



Print at 100%. No scaling. This box measures 1" x 1". Use the box as an accuracy guide when printing templates.

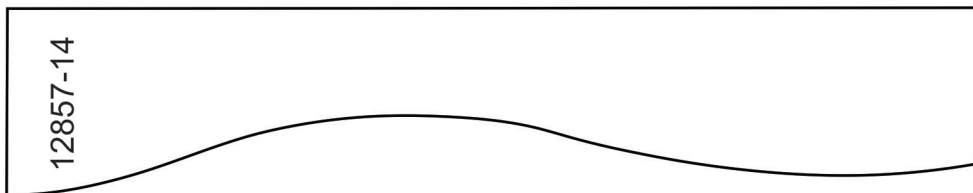
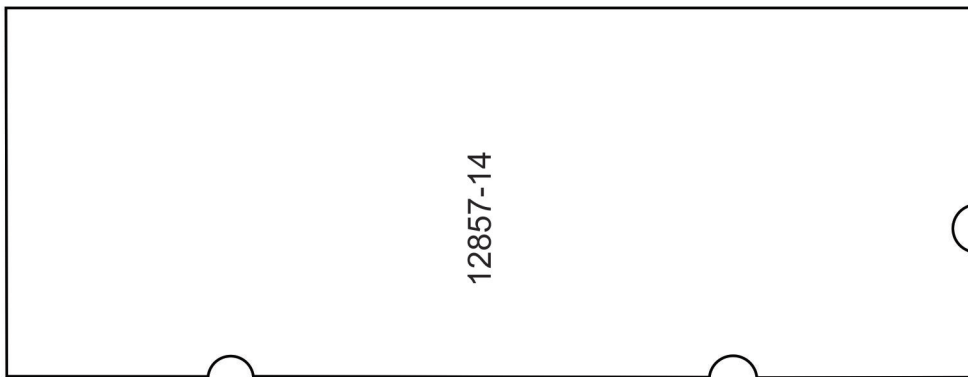
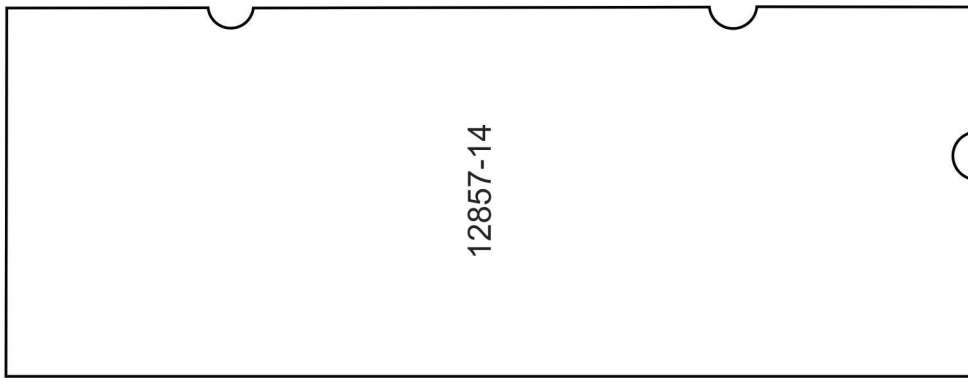



# APPLIQUE PATTERNS



Print at 100%. No scaling. This box measures 1" x 1". Use the box as an accuracy guide when printing templates.

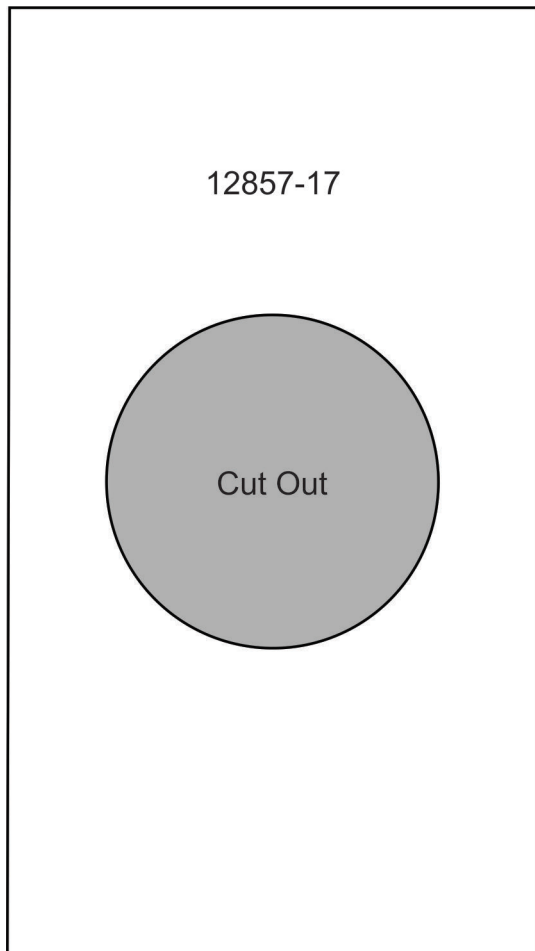
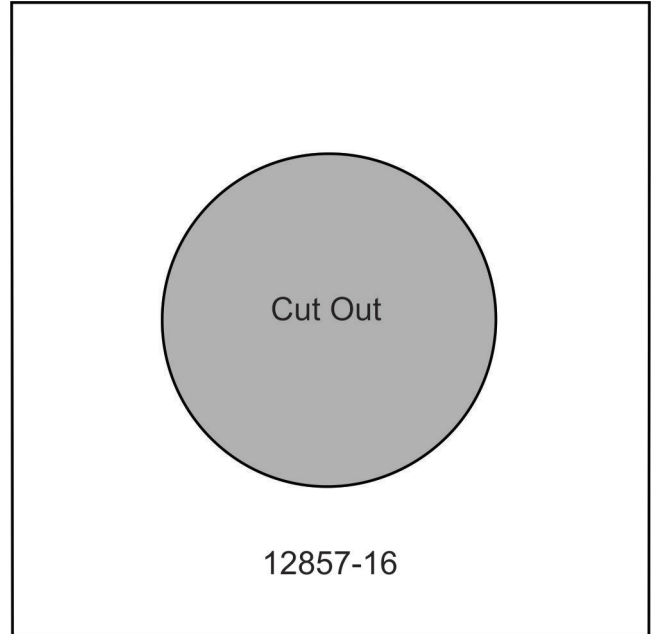
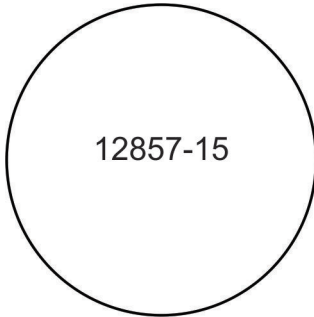

# MIRRORED PATTERNS



Print at 100%. No scaling. This box measures 1" x 1". Use the box as an accuracy guide when printing templates.

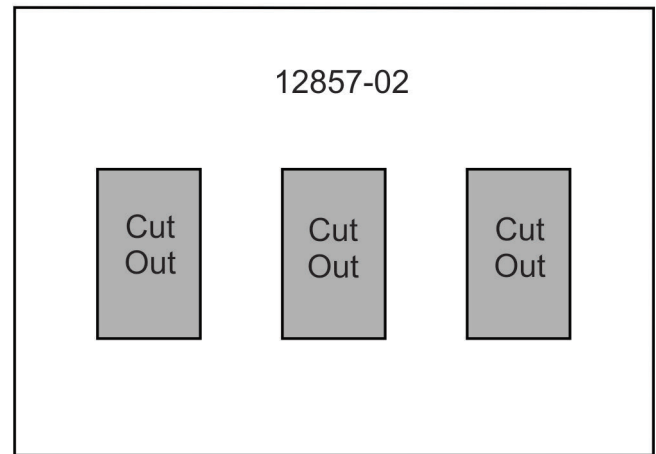
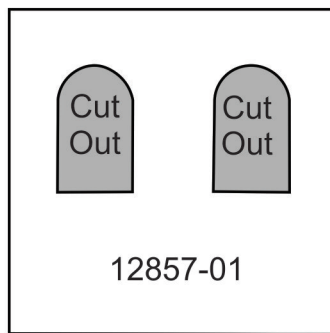
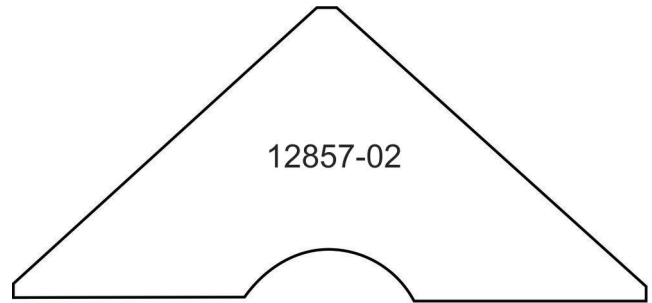
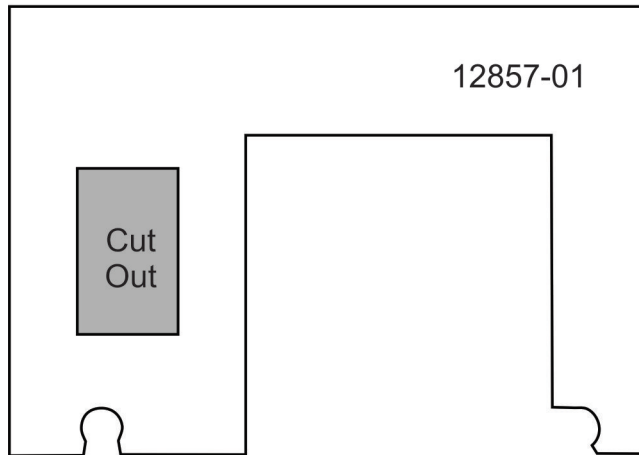
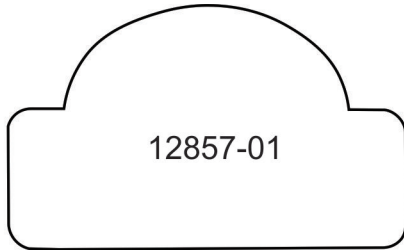

# MIRRORED PATTERNS



Print at 100%. No scaling. This box measures 1" x 1". Use the box as an accuracy guide when printing templates.

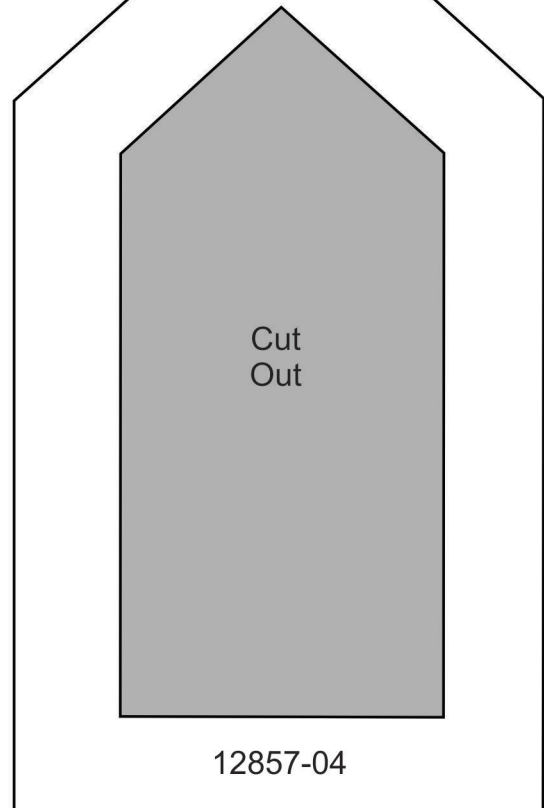
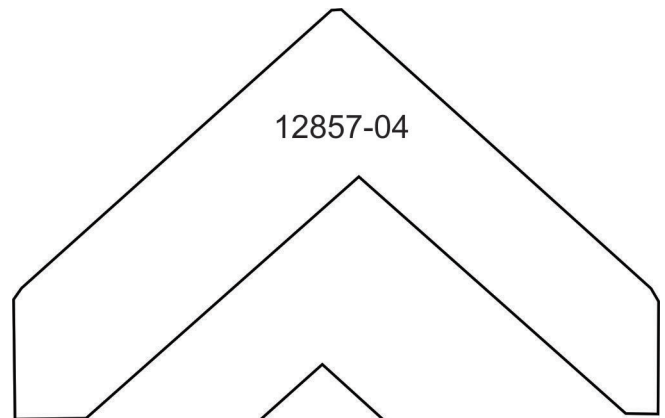
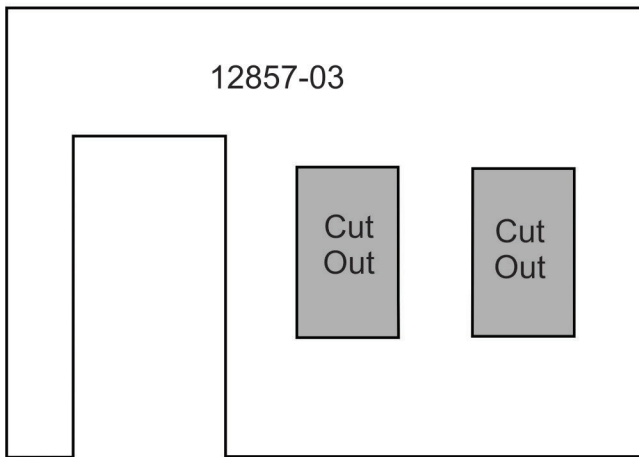
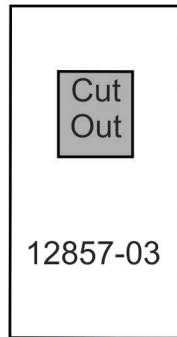

# MIRRORED PATTERNS



Print at 100%. No scaling. This box measures 1" x 1". Use the box as an accuracy guide when printing templates.

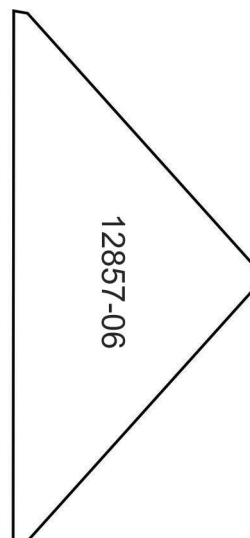
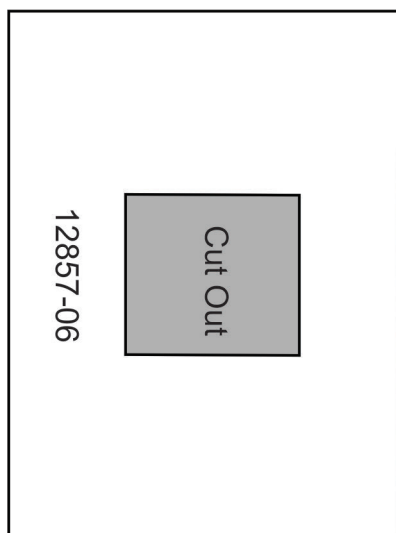
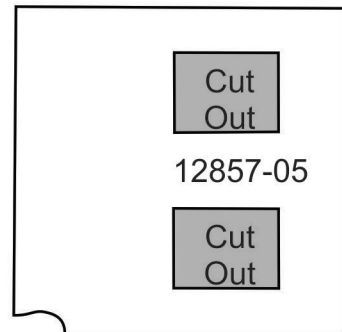
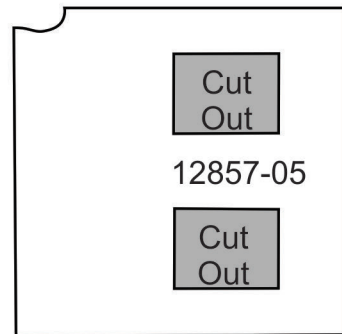
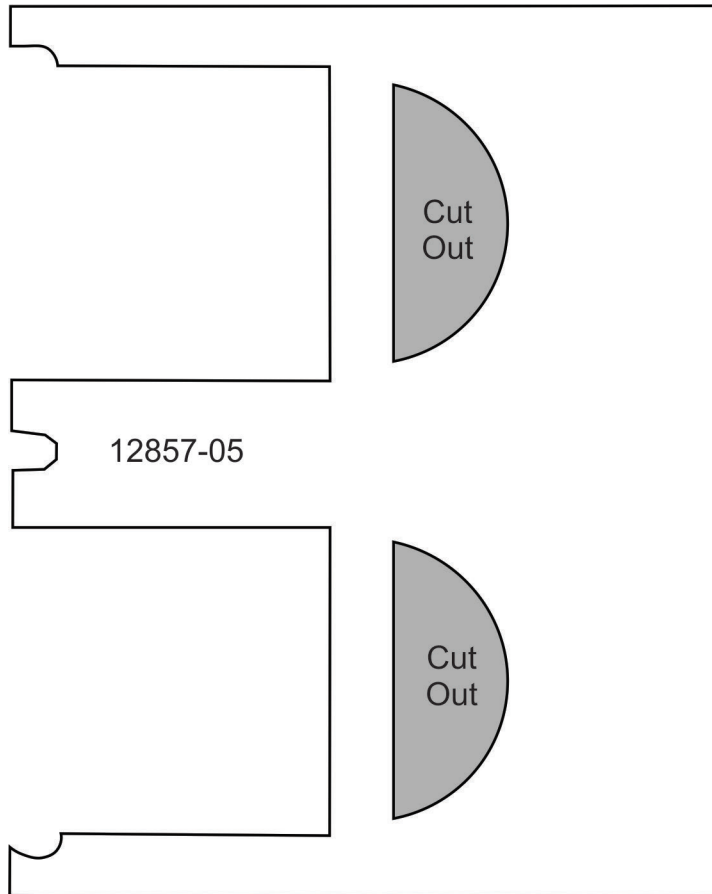

# MIRRORED PATTERNS



Print at 100%. No scaling. This box measures 1" x 1". Use the box as an accuracy guide when printing templates.

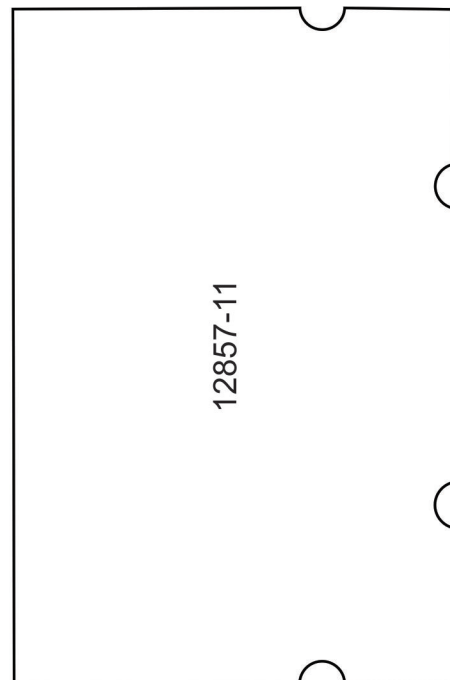
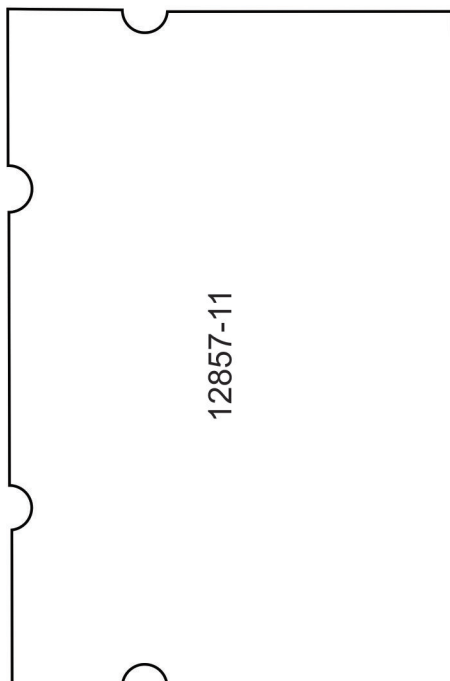
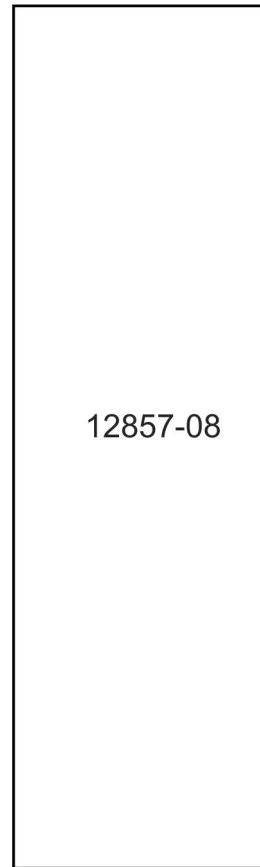
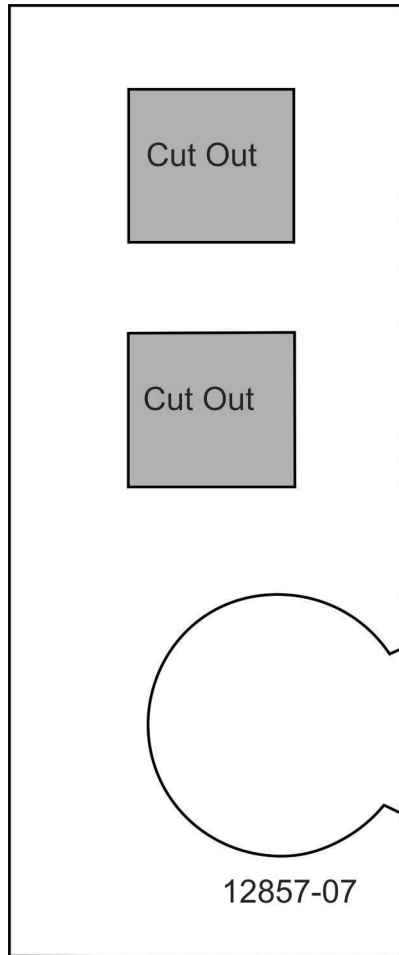

# MIRRORED PATTERNS



Print at 100%. No scaling. This box measures 1" x 1". Use the box as an accuracy guide when printing templates.

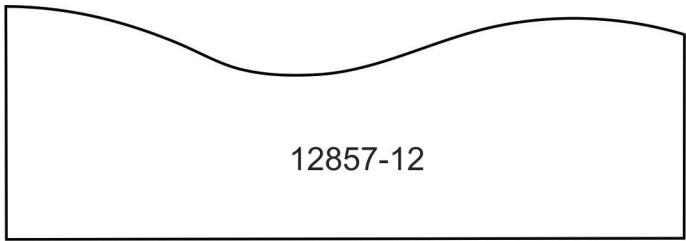

12857-12

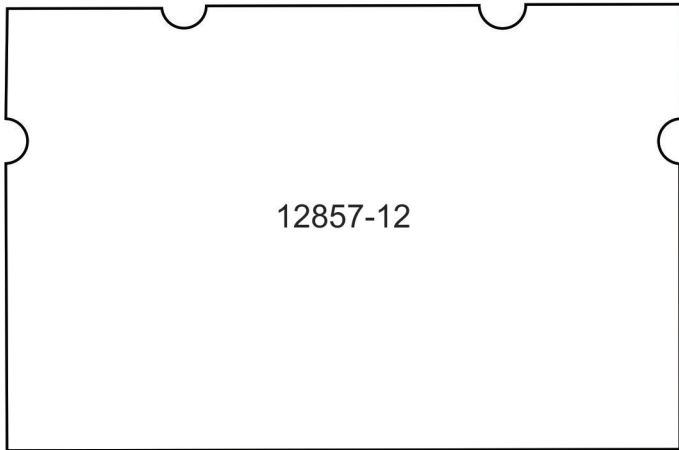

12857-12

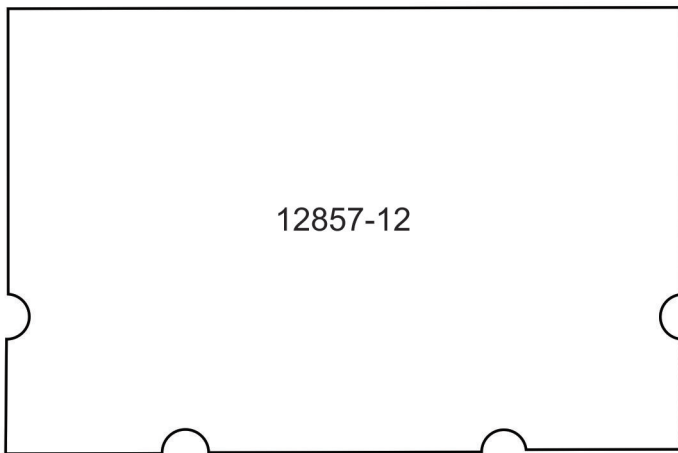

12857-12

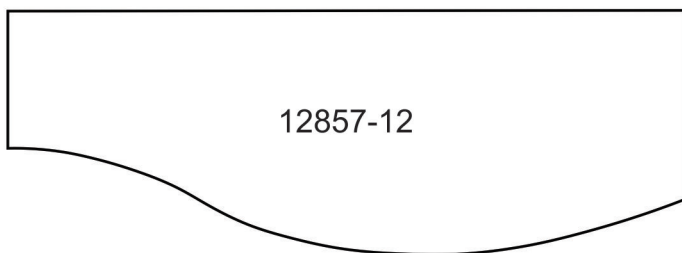

12857-12

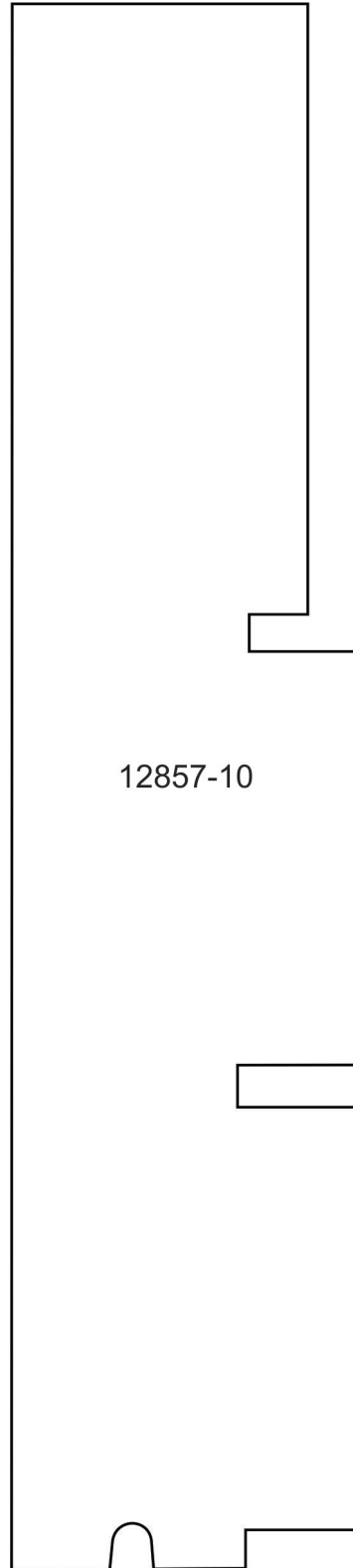

12857-10

# MIRRORED PATTERNS



Print at 100%. No scaling. This box measures 1" x 1". Use the box as an accuracy guide when printing templates.

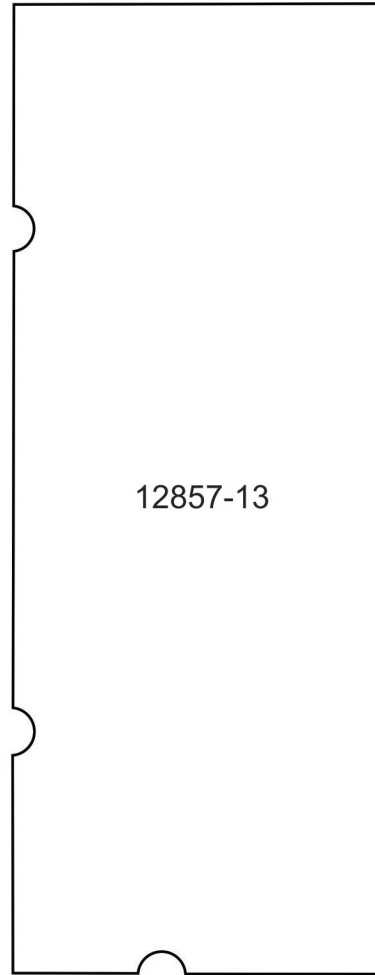
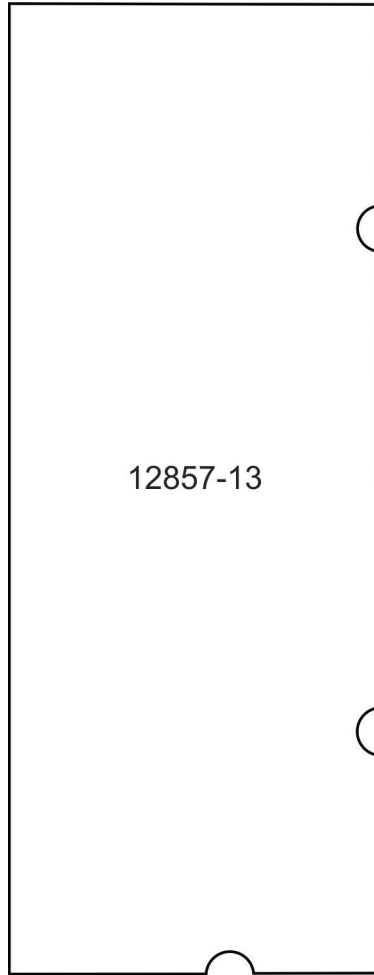

# MIRRORED PATTERNS



Print at 100%. No scaling. This box measures 1" x 1". Use the box as an accuracy guide when printing templates.

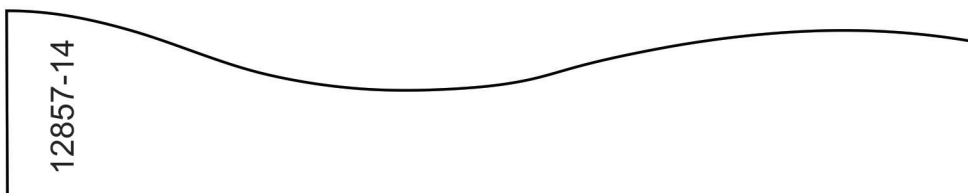
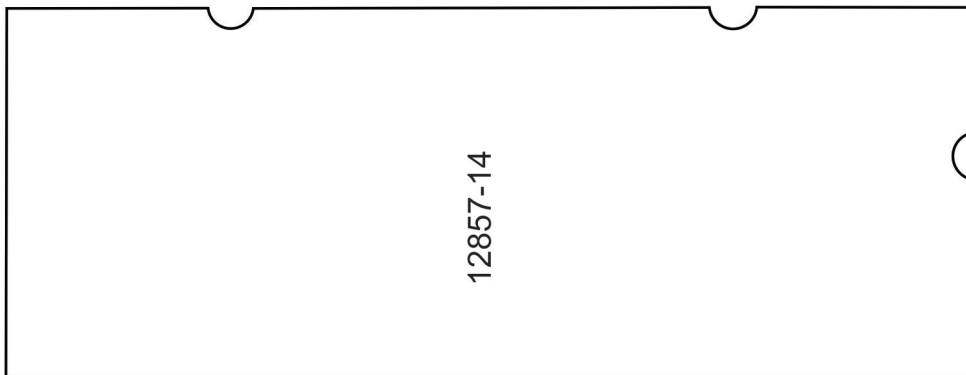
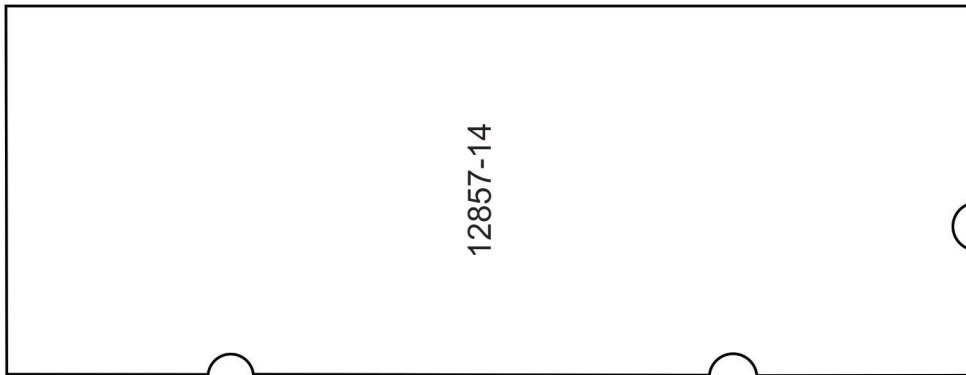
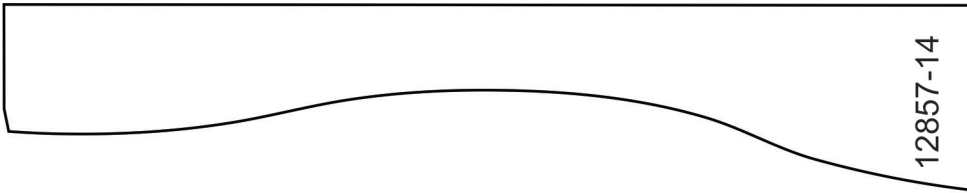



# MIRRORED PATTERNS



Print at 100%. No scaling. This box measures 1" x 1". Use the box as an accuracy guide when printing templates.

