

FREESTANDING MIDNIGHT MANOR



1

Design

Fits hoop sizes 6" x 10" and larger

THREAD LIST



Isacord Thread Colors

- 0015 White
- 0108 Cobblestone
- 0145 Skylight
- 1260 ISA TEXTLIGHT
- 4174 Charcoal

***Project instructions included after design list**

DESIGNS

Note: Some designs in this collection may have been created using unique special stitches and/or techniques. To preserve design integrity when rescaling or rotating designs in your software, always rescale or rotate designs using the handles directly on-screen.

***Fabric Required**

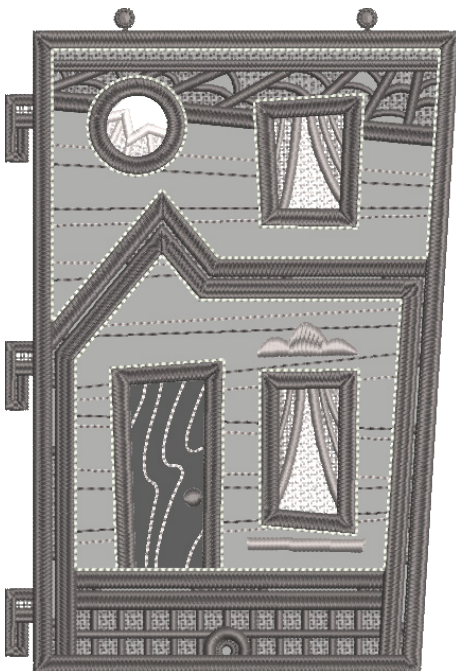

12872-01 Front Wall FSA

Size Inches: Size mm: Stitch Count:
7.38 X 5.01 in. 187.4 X 127.1 mm 53213 St.

- 1. Light Grey Fabric Placement Stitch..... 4174
- 2. Cut Line and Tackdown 4174
- 3. Grey Fabric Placement Stitch..... 4174
- 4. Cut Line and Tackdown 4174
- 5. Grey Detail 4174
- 6. Windows..... 0015
- 7. Door Detail 0145
- 8. Curtains and Grey Detail..... 0108
- 9. Lace and Cover Stitch 4174
- 10. Glow Detail 1260

Note: Some designs in this collection may have been created using unique special stitches and/or techniques. To preserve design integrity when rescaling or rotating designs in your software, always rescale or rotate designs using the handles directly on-screen.

***Fabric Required**

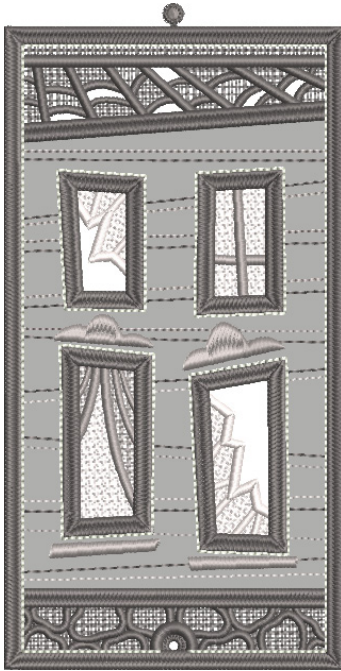

12872-02 Side Wall 1 FSA

Size Inches: **7.37 X 3.74 in.** Size mm: **187.2 X 94.9 mm** Stitch Count: **38430 St.**

- 1. Light Grey Fabric Placement Stitch..... 4174
- 2. Cut Line and Tackdown 4174
- 3. Dark Grey Detail..... 4174
- 4. Light Grey Detail..... 0108
- 5. Windows..... 0015
- 6. Curtains and Window Detail 0108
- 7. Lace and Cover Stitch 4174
- 8. Glow Detail 1260

***Fabric Required**

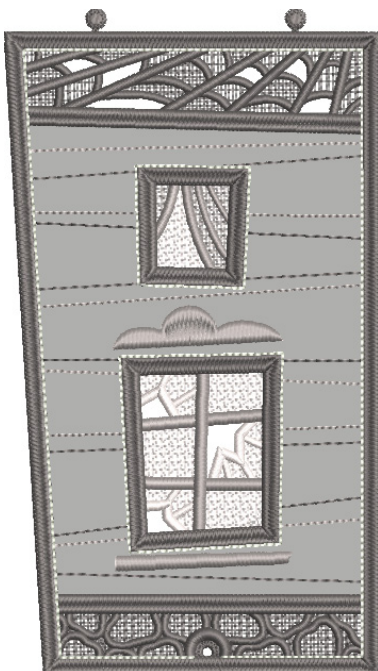

12872-03 Back Wall 1 FSA

Size Inches: **7.36 X 4.13 in.** Size mm: **186.9 X 104.8 mm** Stitch Count: **34260 St.**

- 1. Light Grey Fabric Placement Stitch..... 0108
- 2. Cut Line and Tackdown 0108
- 3. Light Grey Detail..... 0108
- 4. Windows..... 0015
- 5. Window Detail 0108
- 6. Lace and Cover Stitch 4174
- 7. Glow 1260

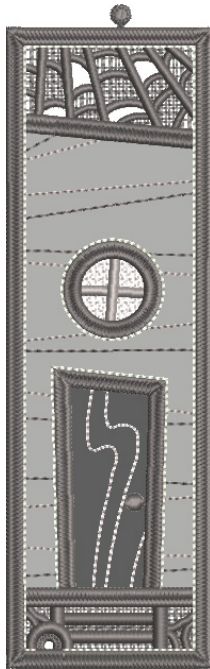

Note: Some designs in this collection may have been created using unique special stitches and/or techniques. To preserve design integrity when rescaling or rotating designs in your software, always rescale or rotate designs using the handles directly on-screen.

***Fabric Required**



12872-04 Back Wall 2 FSA

Size Inches: Size mm: Stitch Count:
7.36 X 2.27 in. 187.1 X 57.7 mm 21435 St.



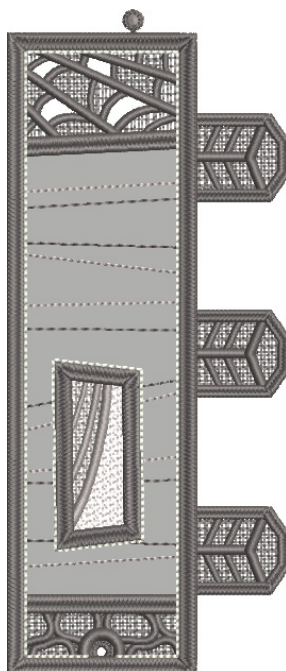

-  1. Light Grey Fabric Placement Stitch..... 0015
-  2. Cut Line and Tackdown 0015
-  3. Grey Fabric Placement Stitch..... 0015
-  4. Cut Line and Tackdown 0015
-  5. Window..... 0015
-  6. Light Grey Detail..... 0145
-  7. Grey Detail 0108
-  8. Lace and Cover Stitch 4174
-  9. Glow Detail 1260

***Fabric Required**



12872-05 Side Wall 2 FSA

Size Inches: Size mm: Stitch Count:
7.37 X 3.11 in. 187.1 X 79.0 mm 26211 St.

-  1. Light Grey Fabric Placement Stitch..... 0015
-  2. Cut Line and Tackdown 0015
-  3. Window..... 0015
-  4. Curtain and Grey Detail..... 0108
-  5. Lace and Cover Stitch 4174
-  6. Glow Detail 1260

Note: Some designs in this collection may have been created using unique special stitches and/or techniques. To preserve design integrity when rescaling or rotating designs in your software, always rescale or rotate designs using the handles directly on-screen.

***Fabric Required**

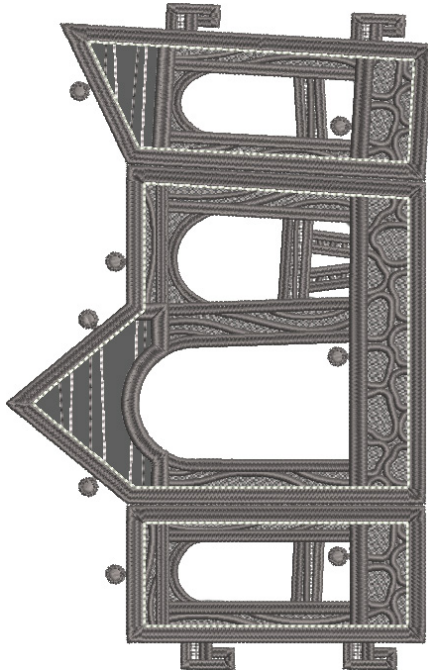

12872-06 Front Porch Walls FSA

Size Inches: Size mm: Stitch Count:
7.91 X 5.03 in. 200.9 X 127.8 mm 58120 St.

- 1. Grey Fabric Placement Stitch..... 0145
- 2. Cut Line and Tackdown 0145
- 3. Light Grey Detail..... 0145
- 4. Lace and Cover Stitch 4174
- 5. Glow Detail 1260

***Fabric Required**

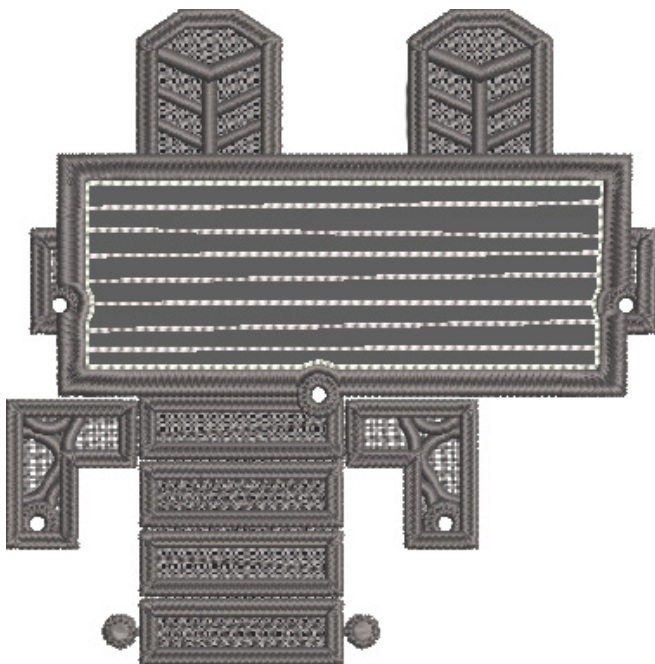

12872-07 Front Porch FSA

Size Inches: Size mm: Stitch Count:
4.44 X 4.40 in. 112.9 X 111.7 mm 23042 St.

- 1. Grey Fabric Placement Stitch..... 0145
- 2. Cut Line and Tackdown 0145
- 3. Light Grey Detail..... 0145
- 4. Lace and Cover Stitch 4174
- 5. Glow Detail 1260

Note: Some designs in this collection may have been created using unique special stitches and/or techniques. To preserve design integrity when rescaling or rotating designs in your software, always rescale or rotate designs using the handles directly on-screen.

***Fabric Required**

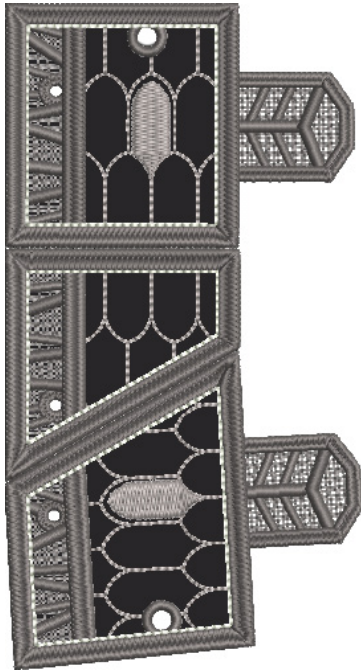

12872-08 Front Porch Roof FSA

Size Inches: Size mm: Stitch Count:
5.91 X 3.15 in. 150.1 X 80.0 mm 24006 St.

- 1. Dark Grey Fabric Placement Stitch 0108
- 2. Cut Line and Tackdown 0108
- 3. Grey Detail 0108
- 4. Lace and Cover Stitch 4174
- 5. Glow Detail 1260

***Fabric Required**



12872-09 Tower Back Wall FSA

Size Inches: Size mm: Stitch Count:
8.50 X 2.68 in. 215.9 X 68.1 mm 24896 St.

- 1. Grey Fabric Placement Stitch..... 0145
- 2. Cut Line and Tackdown 0145
- 3. Light Grey Detail..... 0145
- 4. Lace and Cover Stitch 4174
- 5. Glow Detail 1260

Note: Some designs in this collection may have been created using unique special stitches and/or techniques. To preserve design integrity when rescaling or rotating designs in your software, always rescale or rotate designs using the handles directly on-screen.

***Fabric Required**

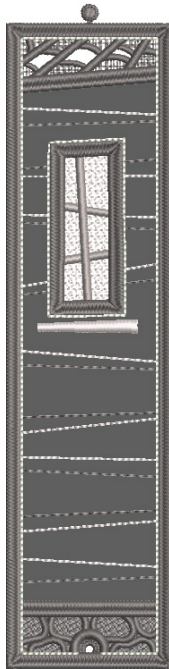

12872-10 Tower Side Wall 1 FSA

Size Inches: Size mm: Stitch Count:
8.75 X 2.18 in. 222.2 X 55.3 mm 20503 St.

- 1. Grey Fabric Placement Stitch..... 0015
- 2. Cut Line and Tackdown 0015
- 3. Window..... 0015
- 4. Light Grey Detail..... 0145
- 5. Window Detail 0108
- 6. Lace and Cover Stitch 4174
- 7. Glow Detail 1260

***Fabric Required**



12872-11 Tower Front Wall FSA

Size Inches: Size mm: Stitch Count:
8.75 X 2.52 in. 222.3 X 64.1 mm 27205 St.

- 1. Grey Fabric Placement Stitch..... 0145
- 2. Cut Line and Tackdown 0145
- 3. Light Grey Detail..... 0145
- 4. Dark Grey Detail..... 4174
- 5. Windows..... 0015
- 6. Curtains 0108
- 7. Lace and Cover Stitch 4174
- 8. Glow Detail 1260

Note: Some designs in this collection may have been created using unique special stitches and/or techniques. To preserve design integrity when rescaling or rotating designs in your software, always rescale or rotate designs using the handles directly on-screen.

***Fabric Required**

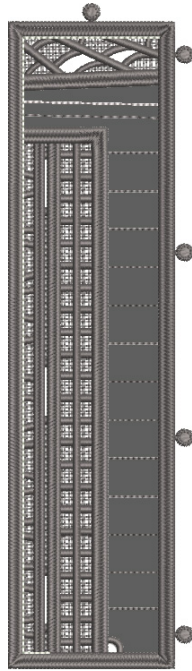

12872-12 Tower Side Wall 2 FSA

Size Inches: Size mm: Stitch Count:
8.74 X 2.42 in. 222.0 X 61.5 mm 27662 St.

- 1. Grey Fabric Placement Stitch..... 0145
- 2. Cut Line and Tackdown 0145
- 3. Light Grey Detail..... 0145
- 4. Lace and Cover Stitch 4174
- 5. Glow Detail 1260

***Fabric Required**

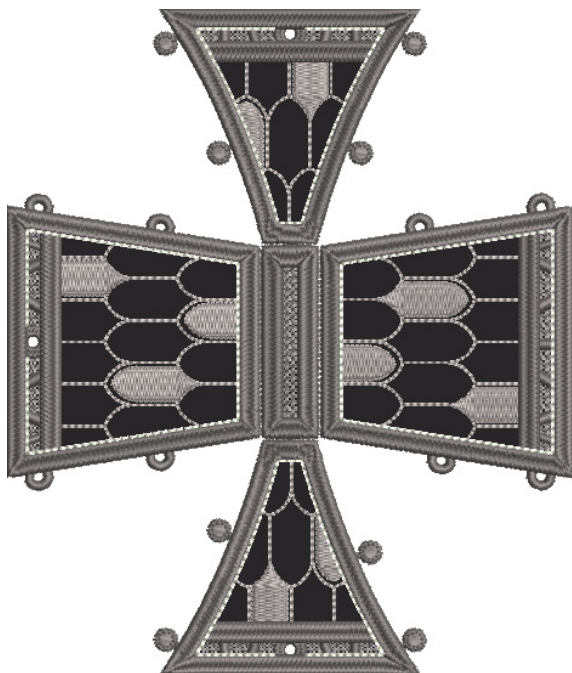

12872-13 Tower Roof FSA

Size Inches: Size mm: Stitch Count:
6.44 X 5.45 in. 163.7 X 138.4 mm 30698 St.

- 1. Dark Grey Fabric Placement Stitch..... 0108
- 2. Cut Line and Tackdown 0108
- 3. Grey Detail 0108
- 4. Lace and Cover Stitch 4174
- 5. Glow Detail 1260

Note: Some designs in this collection may have been created using unique special stitches and/or techniques. To preserve design integrity when rescaling or rotating designs in your software, always rescale or rotate designs using the handles directly on-screen.

***Fabric Required**



12872-14 Roof Top FSA

Size Inches:	Size mm:	Stitch Count:
5.28 X 0.76 in.	134.1 X 19.3 mm	6192 St.

- 1. Dark Grey Fabric Placement Stitch 4174
- 2. Cut Line and Tackdown 4174
- 3. Grey Detail and Cover Stitch 4174
- 4. Glow Detail 1260

***Fabric Required**

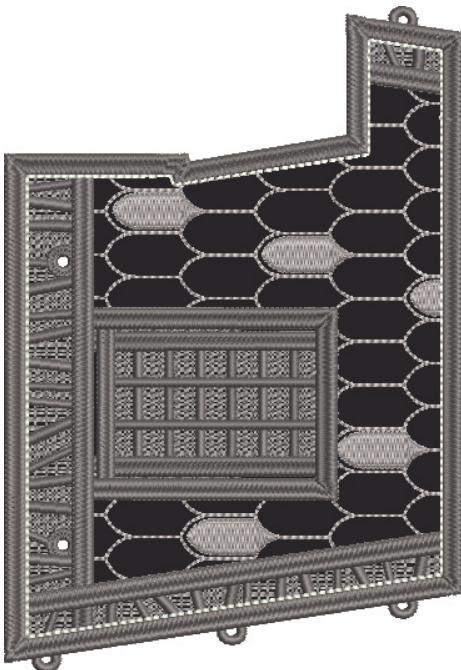

12872-15 Front Roof FSA

Size Inches:	Size mm:	Stitch Count:
6.27 X 4.29 in.	159.2 X 108.9 mm	31526 St.

- 1. Dark Grey Fabric Placement Stitch 0108
- 2. Cut Line and Tackdown 0108
- 3. Grey Detail 0108
- 4. Cover Stitch 4174
- 5. Glow Detail 1260

Note: Some designs in this collection may have been created using unique special stitches and/or techniques. To preserve design integrity when rescaling or rotating designs in your software, always rescale or rotate designs using the handles directly on-screen.

***Fabric Required**

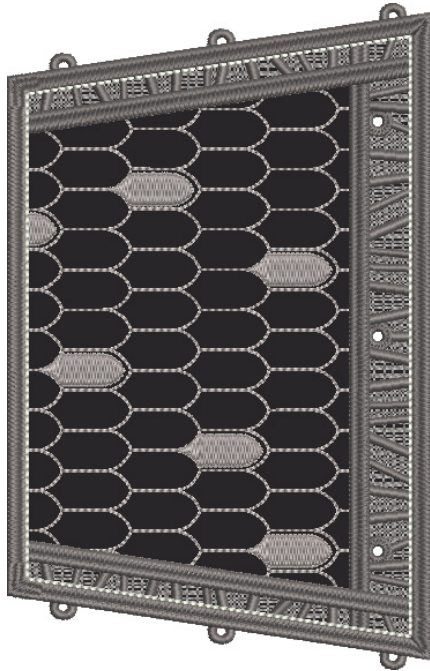

12872-16 Back Roof FSA

Size Inches: Size mm: Stitch Count:
6.78 X 4.29 in. 172.1 X 108.9 mm 29963 St.

- 1. Dark Grey Fabric Placement Stitch 0108
- 2. Cut Line and Tackdown 0108
- 3. Grey Detail 0108
- 4. Cover Stitch 4174
- 5. Glow Detail 1260

***Fabric Required**

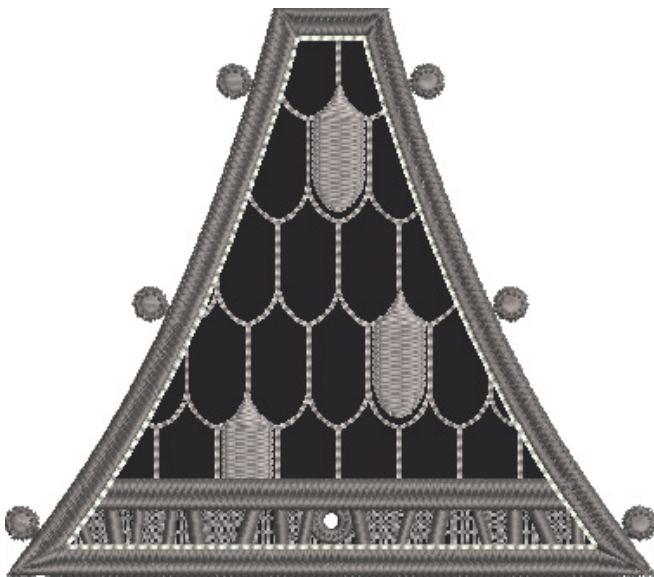

12872-17 Side Roof 1 FSA

Size Inches: Size mm: Stitch Count:
3.86 X 4.39 in. 98.0 X 111.6 mm 12482 St.

- 1. Dark Grey Fabric Placement Stitch 0108
- 2. Cut Line and Tackdown 0108
- 3. Grey Detail 0108
- 4. Cover Stitch 4174
- 5. Glow Detail 1260

Note: Some designs in this collection may have been created using unique special stitches and/or techniques. To preserve design integrity when rescaling or rotating designs in your software, always rescale or rotate designs using the handles directly on-screen.

***Fabric Required**

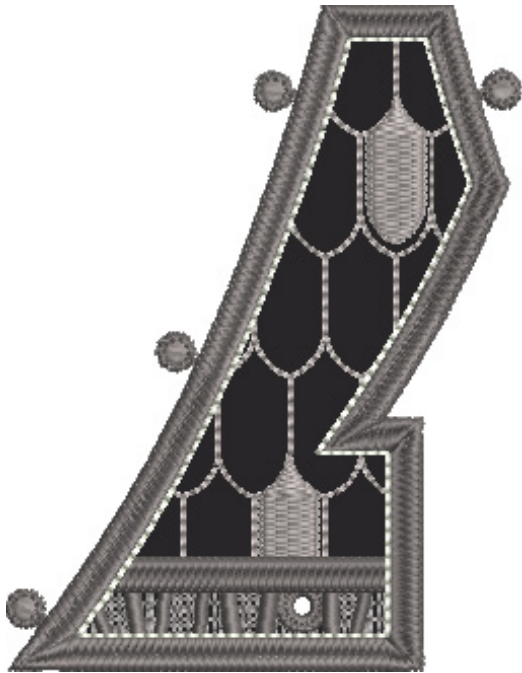

12872-18 Side Roof 2 FSA

Size Inches: Size mm: Stitch Count:
3.86 X 2.97 in. 98.0 X 75.5 mm 9120 St.

- 1. Dark Grey Fabric Placement Stitch 0108
- 2. Cut Line and Tackdown 0108
- 3. Grey Detail 0108
- 4. Cover Stitch 4174
- 5. Glow Detail 1260

***Fabric Required**

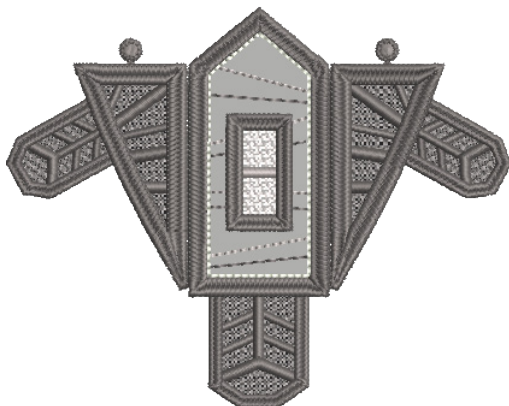

12872-19 Dormer Window FSA

Size Inches: Size mm: Stitch Count:
6.49 X 4.90 in. 165.0 X 124.6 mm 23096 St.

- 1. Roof Grey Fabric/Window Light Grey Fabric Placement Stitch 0145
- 2. Cut Line and Tackdown 0145
- 3. Grey Detail 0145
- 4. Lace and Cover Stitch 4174
- 5. Glow Detail 1260
- 6. Window 0015
- 7. Grey Detail 0108
- 8. Lace and Cover Stitch 4174
- 9. Glow Detail 1260

Note: Some designs in this collection may have been created using unique special stitches and/or techniques. To preserve design integrity when rescaling or rotating designs in your software, always rescale or rotate designs using the handles directly on-screen.

***Fabric Required**

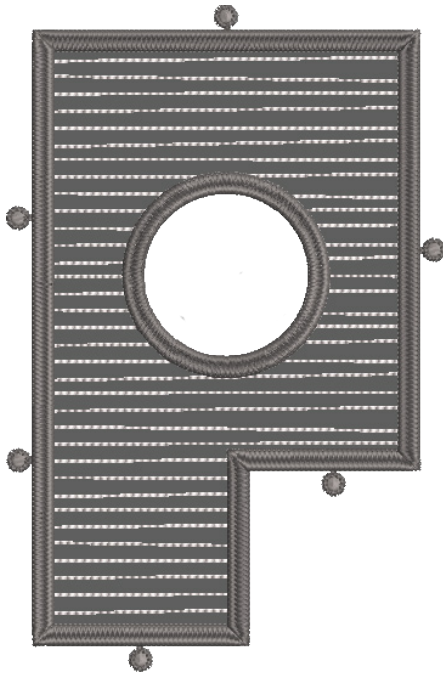

12872-20 Tealight Floor FSA

Size Inches: Size mm: Stitch Count:
6.44 X 4.23 in. 163.7 X 107.4 mm 12041 St.

- 1. Grey Fabric Placement Stitch..... 0145
- 2. Cut Line and Tackdown 0145
- 3. Grey Detail 0145
- 4. Cover Stitch..... 4174

***Fabric Required**

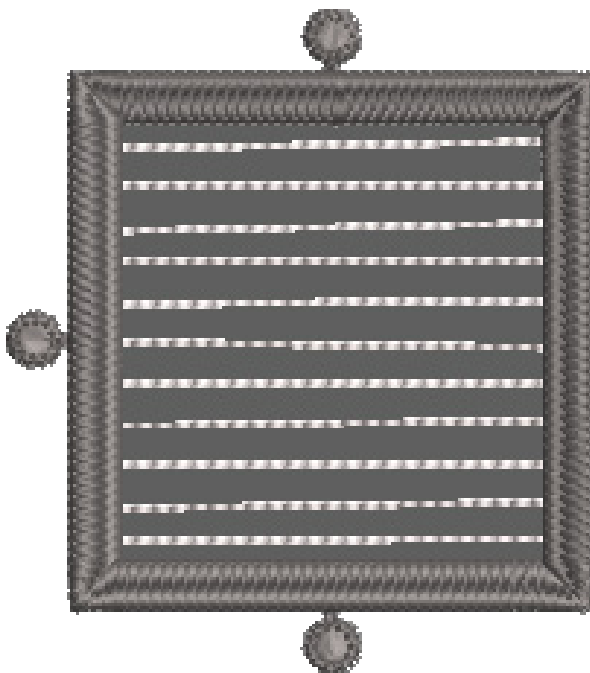

12872-21 Tower Floor FSA

Size Inches: Size mm: Stitch Count:
2.69 X 2.36 in. 68.4 X 60.1 mm 3913 St.

- 1. Grey Fabric Placement Stitch..... 0145
- 2. Cut Line and Tackdown 0145
- 3. Grey Detail 0145
- 4. Cover Stitch..... 4174

Stabilizers

- OESD AquaMesh
- OESD BadgeMaster
- OESD StabilStick CutAway

Fabrics/Textiles

- ¼ yard Light Grey Fabric
- ¼ yard Medium Grey Fabric
- ¼ yard Dark Grey Fabric
- Roof Variation: substitute Luxe Sparkle Vinyl by OESD in Black (1 roll) for Dark Gray Fabric.
- Note: Fabric sizes are estimates and may result in overage.

Notions & Tools

- OESD Alligator Clamps
- OESD Expert Embroidery Tape WashAway
- OESD Perfect Punch Tool
- OESD Perfect Embroidery Press Cloth
- Optional: Button Clips

Isacord Thread Colors

- Per thread chart
- Match bobbin thread to top thread.

SUMMARY



12872-01

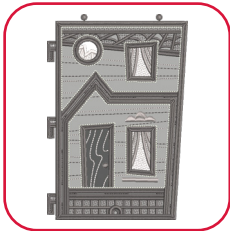

Requires 1 Design

12872-02



Requires 1 Design

12872-03

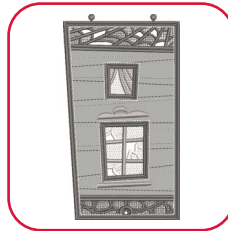

Requires 1 Design

12872-04

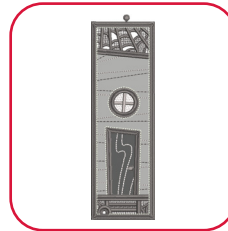

Requires 1 Design

12872-05

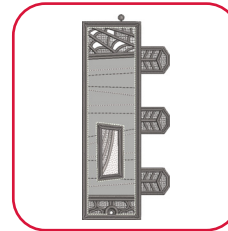

Requires 1 Design

12872-06

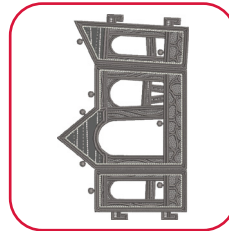

Requires 1 Design

12872-07

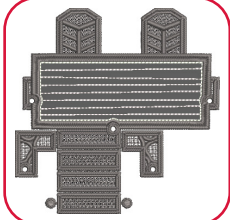

Requires 1 Design

12872-08

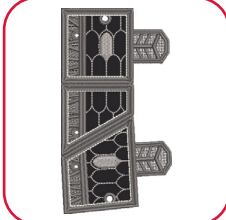

Requires 1 Design

12872-09

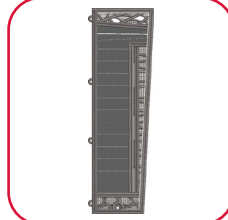

Requires 1 Design

12872-10



Requires 1 Design

12872-11

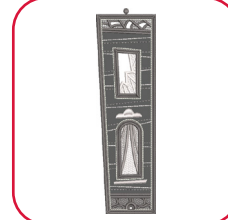

Requires 1 Design

12872-12

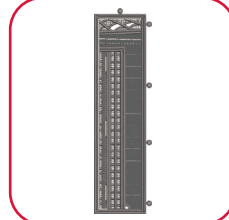

Requires 1 Design

12872-13

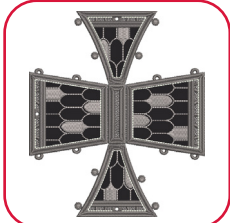

Requires 1 Design

12872-14



Requires 1 Design

12872-5

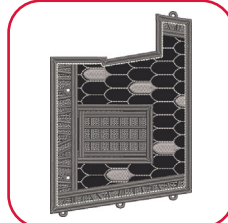

Requires 1 Design

12872-16

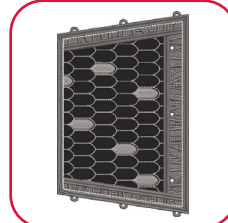

Requires 1 Design

12872-17

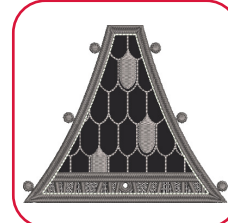

Requires 1 Design

12872-18

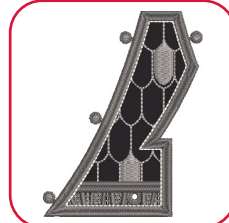

Requires 1 Design

12872-19

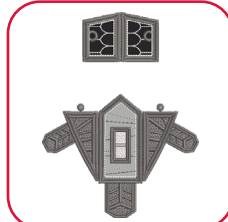

Requires 1 Design

12872-20

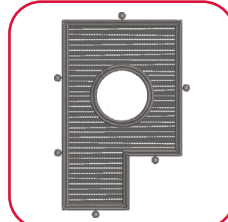

Requires 1 Design

12872-21

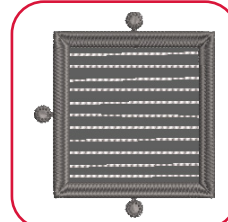

Requires 1 Design

EMBROIDERY



STEP 1

- Adhere two layers of StabilStick CutAway to the wrong side of all applique fabrics to provide stiffness to the finished structure.

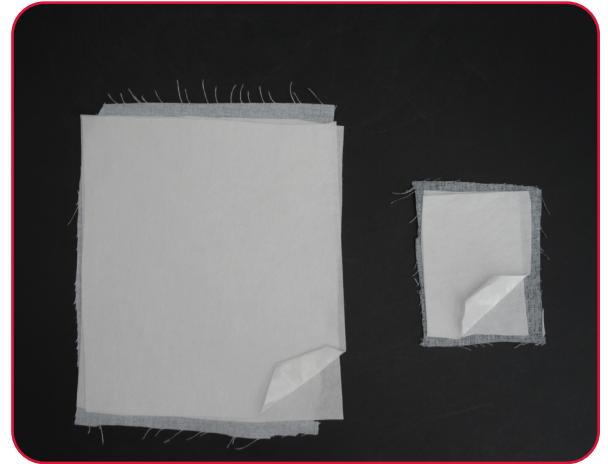

STEP 2

- Hoop one layer of AquaMesh and one layer of BadgeMaster in the hoop for all designs.



STEP 3

- Load selected design into the machine.
- Design in the example is 12872-01.
- Thread the machine per the thread chart.
- Stitch Machine Step 1, Light Grey Fabric Placement Stitch.
- Note: Some thread colors in instructions have been changed or digitally enhanced for better visibility.

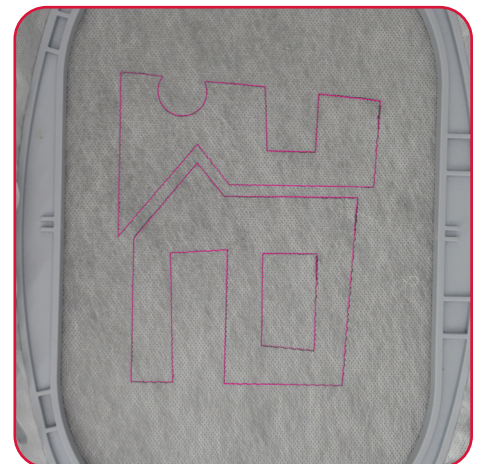

STEP 4

- Remove the hoop from the machine, but NOT the project from the hoop.
- Lay the hoop on a flat surface.
- Cover the placement line completely with the prepared fabric.
- Tape in place to secure.



STEP 5

- Return the hoop to the machine.
- Stitch Machine Step 2, Cut Line and Tackdown.



STEP 6

- Remove the hoop from the machine, but NOT the project from the hoop.
- Trim the excess fabric as close to the cut line as possible. If the outermost stitches are cut, the inner stitches will still hold the applique in place.
- Tip: If the AquaMesh is cut or a hole is created while trimming the fabric, use Expert Embroidery Tape WashAway or AquaMesh Plus as a patch.

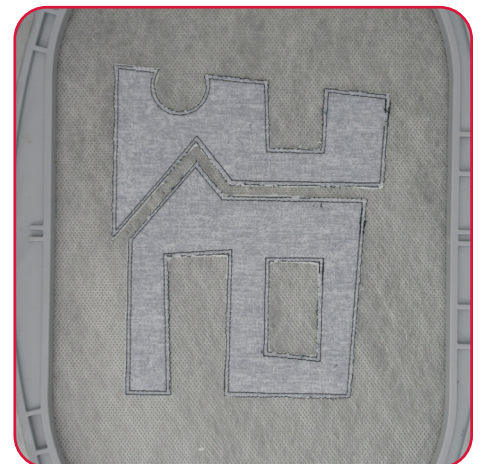

STEP 7

- Return the hoop to the machine.
- Stitch Machine Step 3, Grey Fabric Placement Stitch.

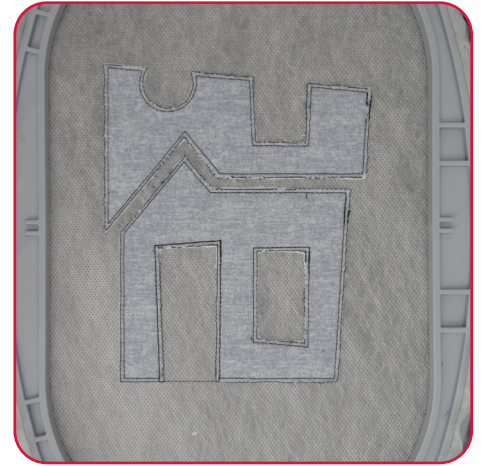

STEP 8

- Remove the hoop from the machine, but NOT the project from the hoop. Lay the hoop on a flat surface.
- Cover the placement line completely with the prepared fabric.
- Tape in place to secure.

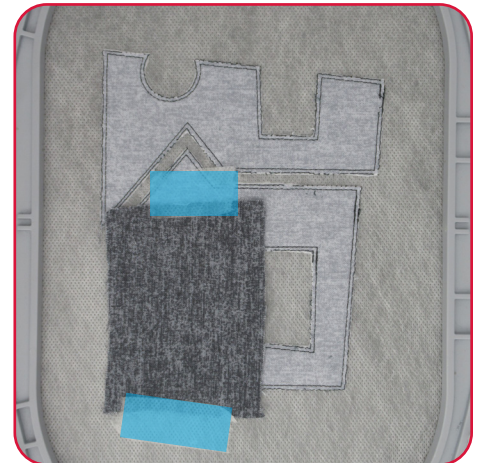

STEP 9

- Return the hoop to the machine.
- Stitch Machine Step 4, Cut Line and Tackdown.

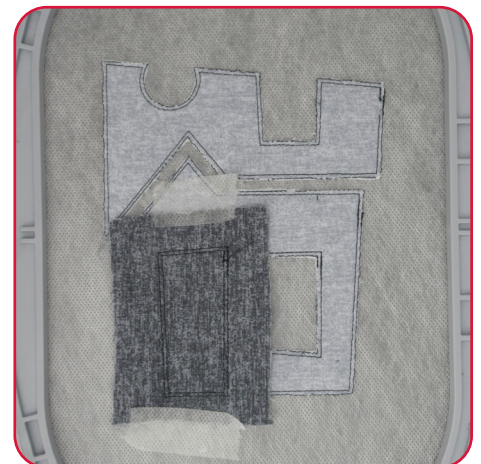

EMBROIDERY



STEP 10

- Remove the hoop from the machine, but NOT the project from the hoop.
- Trim the excess fabric as close to the cut line as possible. If the outermost stitches are cut, the inner stitches will still hold the applique in place.

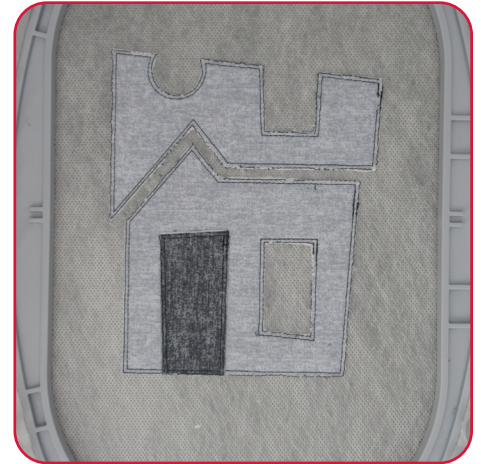

STEP 11

- Return the hoop to the machine and stitch the remaining steps according to the thread chart.
- Remember to match the bobbin thread to the upper thread colors.

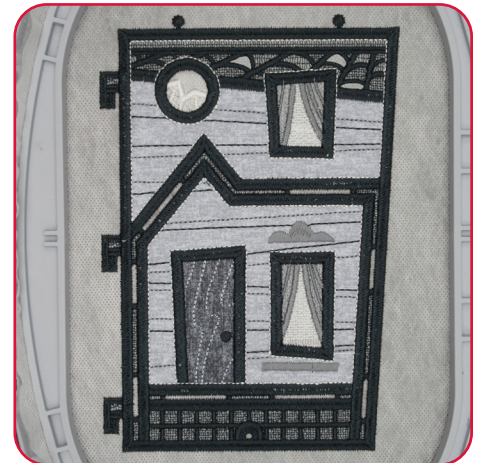

STEP 12

- When design is complete, remove the project from the hoop and trim the stabilizer $\frac{1}{4}$ "- $\frac{1}{2}$ " outside the design.



NOTE ROOF VARIATION WITH LUXE SPARKLE VINYL

- Roof units include 12872-08, 12872-13, 12872-14, 12872-15, 12872-16, 12872-17, 12872-18, 12872-19. Design 12872-19 includes two applique pieces, only the roof is Luxe Sparkle Vinyl.

12872-08

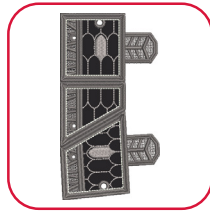

12872-13

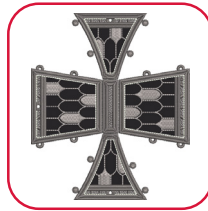

12872-14



12872-15

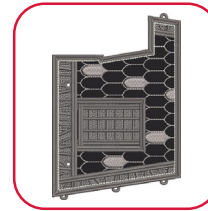

12872-16

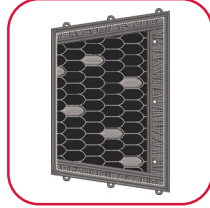

12872-17

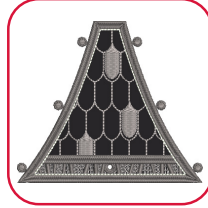

12872-18

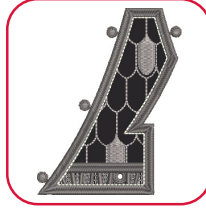

12872-19

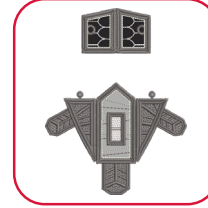

STEP 13

- Adhere two layers of StabilStick CutAway to the wrong side of Luxe Sparkle Vinyl to provide stiffness to the finished structure.



STEP 14

- Hoop one layer of AquaMesh and one layer of BadgeMaster.



STEP 15

- Load selected design into the machine.
- Example design is 12872-16.
- Place the hoop on the machine.
- Thread the machine per the thread chart.
- Stitch Machine Step 1, Dark Grey Fabric Placement Stitch.

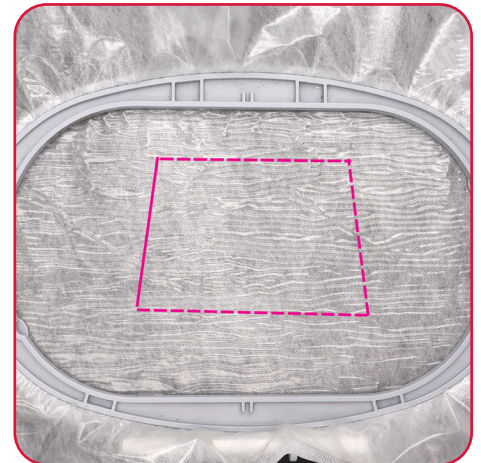

STEP 16

- Remove the hoop from the machine, but NOT the project from the hoop.
- Place the hoop on a flat surface.
- Cover the placement line completely with the prepared fabric.
- Tape in place to secure.

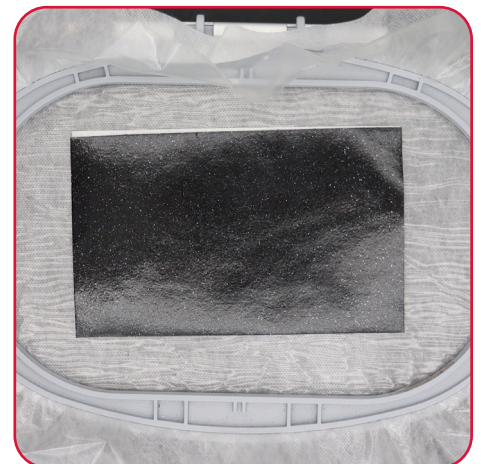

STEP 17

- Return the hoop to the machine.
- Stitch Machine Step 4, Cut Line and Tackdown.

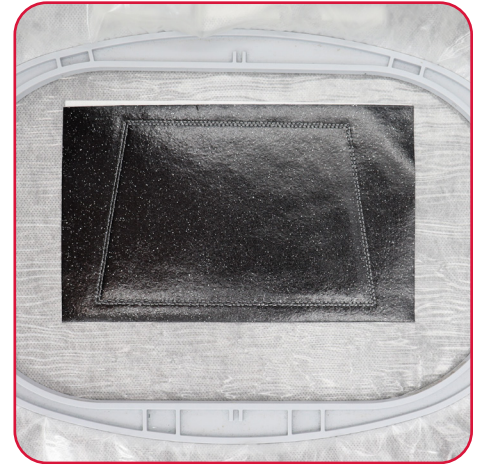

STEP 18

- Remove the hoop from the machine, but NOT the project from the hoop.
- Trim the excess fabric as close to the cut line stitching as possible.

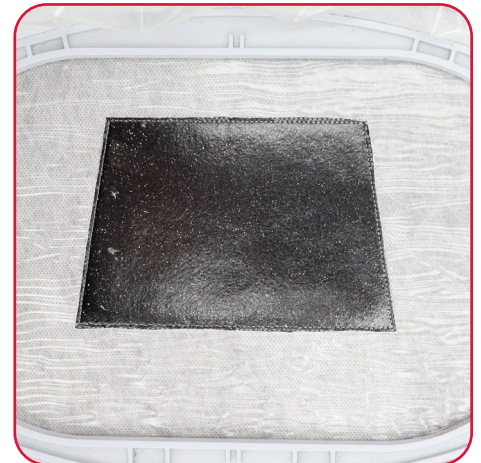

STEP 19

- Return the hoop to the machine and stitch the remaining machine steps per the thread chart.
- Match the bobbin thread to the upper thread colors.

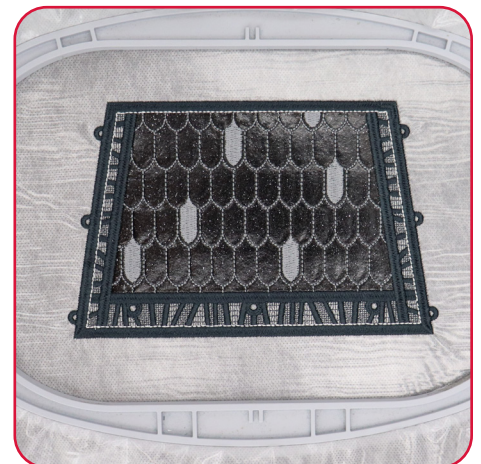

STEP 20

- When the design is complete, remove the project from the hoop and trim the stabilizer 1/4" - 1/2" outside the design.

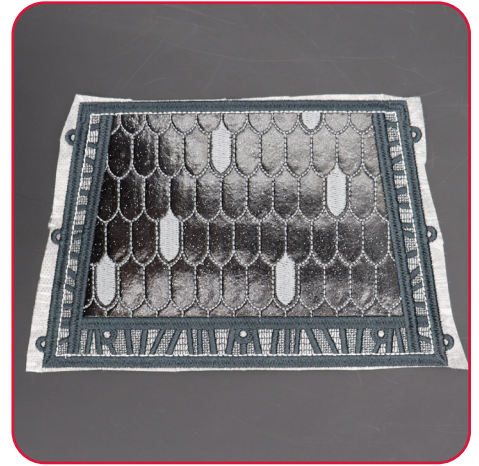

ASSEMBLY



STEP 1

- Rinse each piece in warm running water until the design is only slightly sticky.
- Lay face down on a non-stick surface to dry. Parchment paper or a cooling rack work well. This prevents the piece from curling.
- Press each piece, right side down, on a Perfect Embroidery Press Cloth.

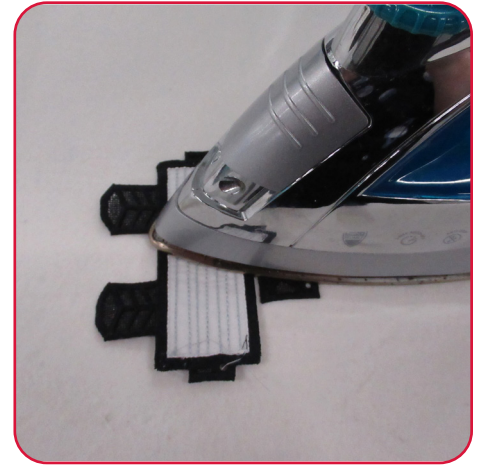

STEP 2

- Insert the 3 mm attachment into the Perfect Punch Tool and punch holes in the eyelets indicated in the Punch tool guides located on pg. 33.

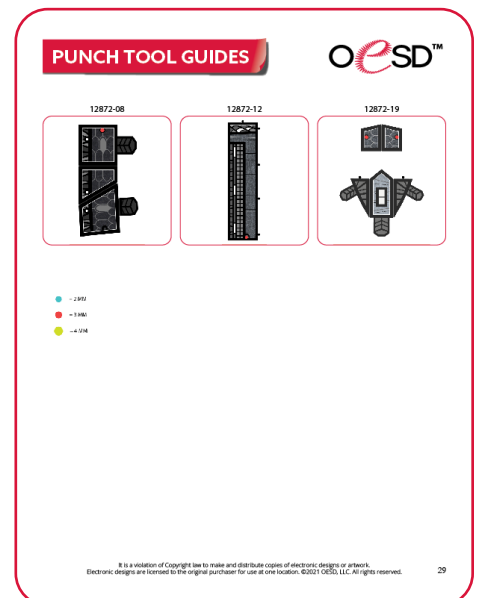

ASSEMBLY



STEP 3

- Line up wall pieces right side up 12872-01, 12872-02, 12872-03, 12872-04 and 12872-05 to connect.
- Load the sewing machine with matching thread in the top and bobbin. An open toe or edge stitch foot is helpful.
- Stitch together using a multi-step zigzag stitch (also known as a serpentine stitch). Back stitch at the beginning and end to secure. Trim thread tails.
- Fold and press to shape.

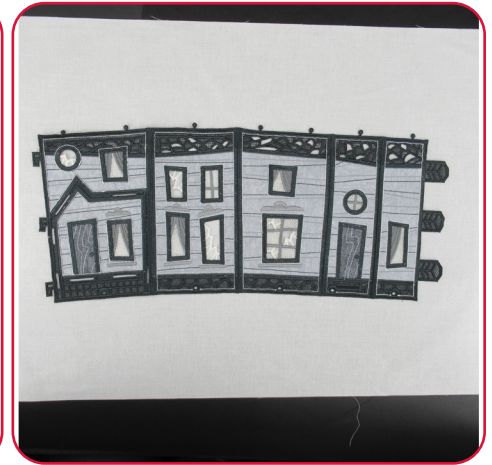
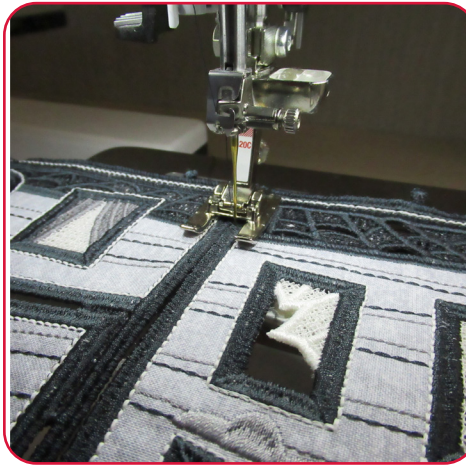

STEP 4

- Line up tower pieces 12872-09, 12872-10, 12872-11 and 12872-12 to connect.
- Stitch together using a multi-step zigzag stitch right side up (also known as a serpentine stitch). Back stitch at the beginning and end to secure. Trim thread tails.
- Fold and press to shape.



STEP 5

- Line up roof pieces, right side up, 12872-14, 12872-15, 12872-16, 12872-17 and 12872-18 to connect.
- Stitch together using a multi-step zigzag stitch (also known as a serpentine stitch). Back stitch at the beginning and end to secure. Trim thread tails.

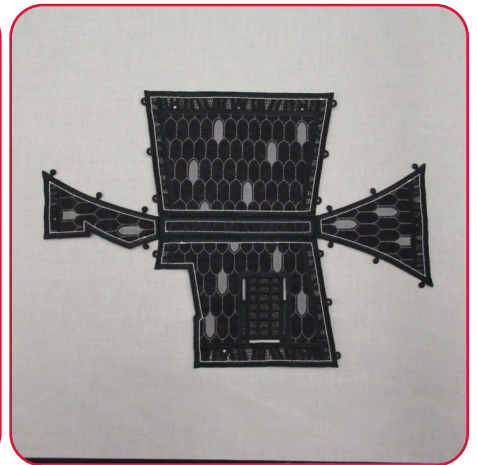
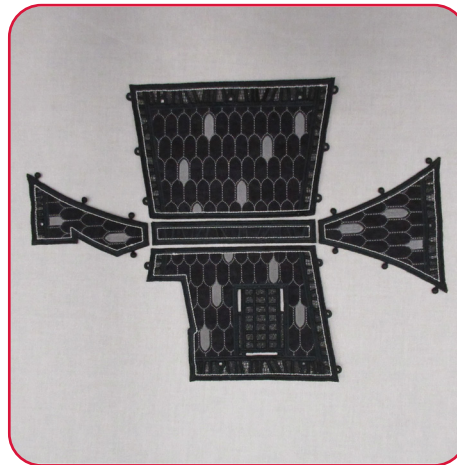

STEP 6

- Match the eyelets and buttonettes on tower roof 12872-13. Pull each buttonette through the corresponding eyelet.

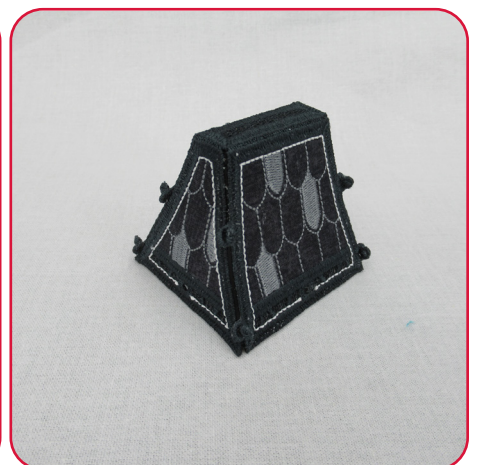
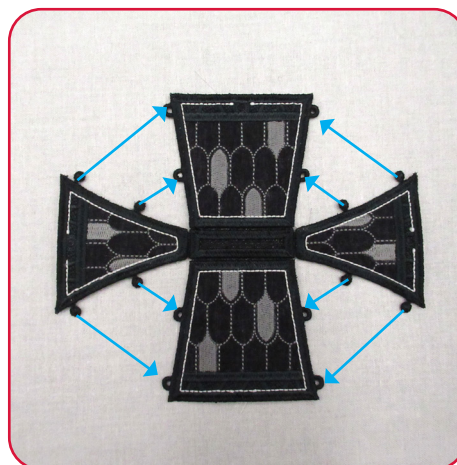

ASSEMBLY



STEP 7

- Match the eyelets and buttonettes of the tower. Pull each buttonette through the corresponding eyelet.

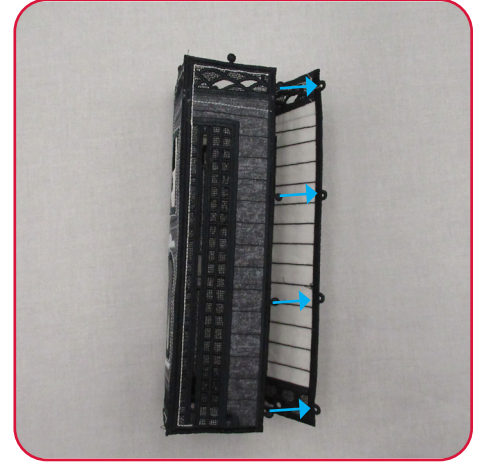

STEP 8

- Match the tower roof eyelets to the tower buttonettes. Pull each buttonette through the corresponding eyelet.

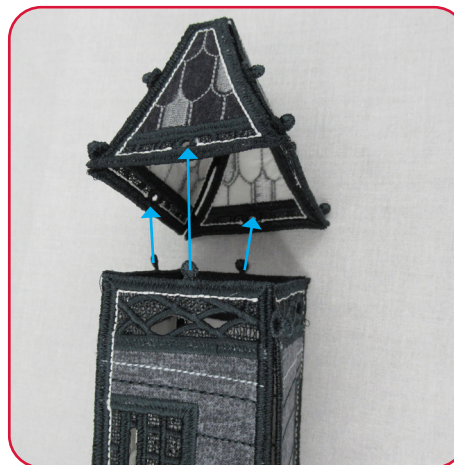

ASSEMBLY



STEP 9

- Match the front porch eyelets and buttonettes 12872-06, 12872-07, and 12872-08 . Pull each buttonette through the corresponding eyelet.

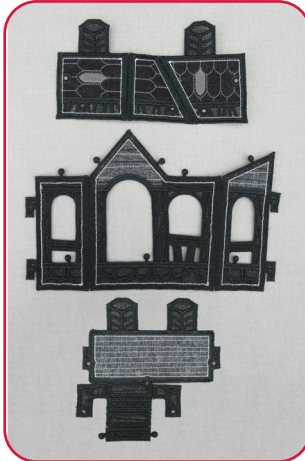

STEP 10

- Insert the front porch tabs into the corresponding front wall slots.
- Note: After putting the tabs into the slots, twist them slightly to help them stay in place, or use Button Clips to temporarily hold them.



STEP 11

- Insert the front wall tabs into the corresponding tower slots.
- Note: After putting the tabs into the slots, twist them slightly to help them stay in place.



STEP 12

- Insert the side wall tabs into the corresponding tower slots.
- Note: After putting the tabs into the slots, twist them slightly to help them stay in place.



STEP 13

- Match the dormer roof eyelets to the dormer window buttonettes 12872-19. Pull each buttonette through the corresponding eyelet.

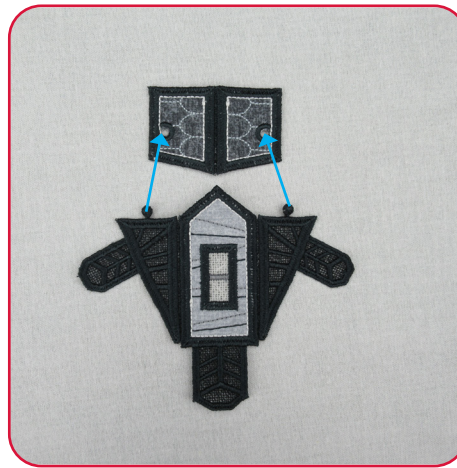

STEP 14

- Match the eyelets and buttonettes of the roof 12872-15, 12872-16, 12872-17 and 12872-18. Pull each buttonette through the corresponding eyelet.

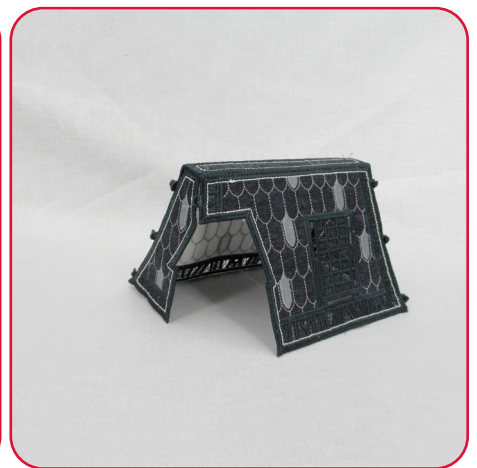
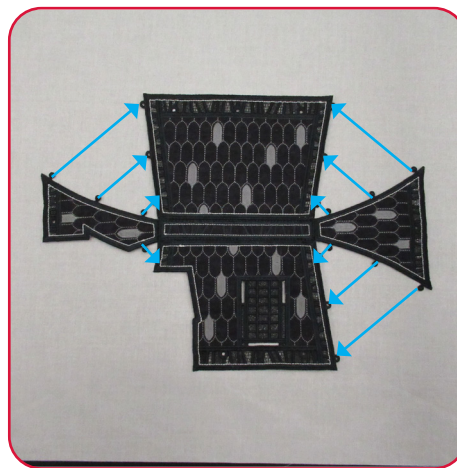

STEP 15

- Insert the dormer tabs into the corresponding roof slots.
- Note: After putting the tabs into the slots, twist them slightly to help them stay in place.

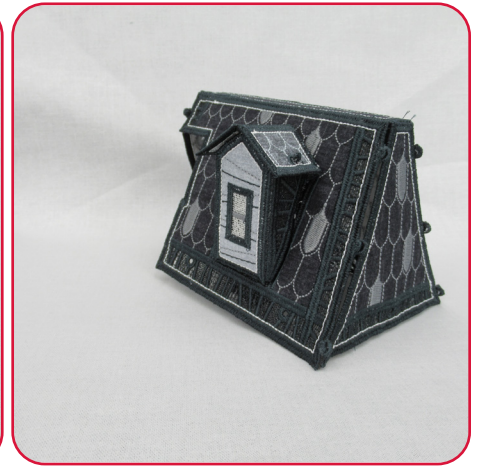

STEP 16

- Match the roof eyelets to the wall buttonettes. Pull each buttonette through the corresponding eyelet.



ASSEMBLY



STEP 17

- Match the tower eyelets to the tower floor buttonettes 12872-21. Pull each buttonette through the corresponding eyelet.

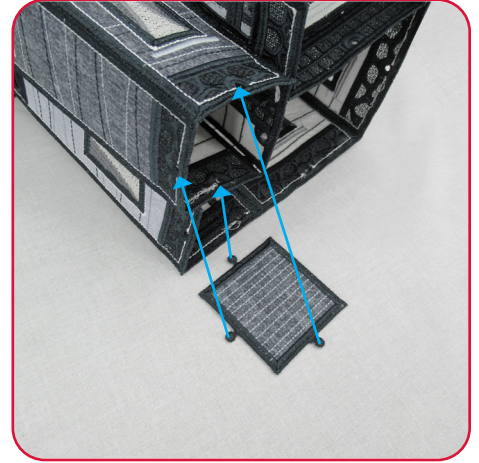

STEP 18

- Match the wall eyelets to the tealight floor buttonettes 12872-20. Pull each buttonette through the corresponding eyelet.

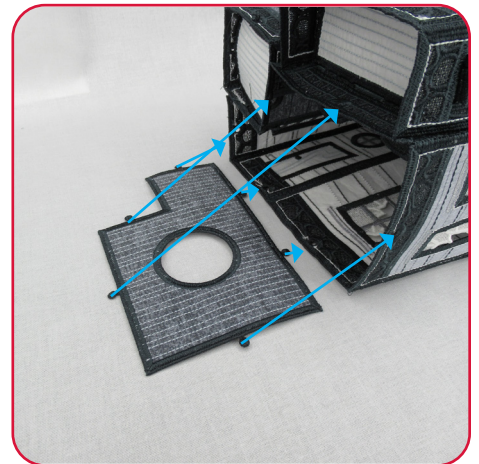

STEP 19

- Freestanding Midnight Manor is now complete.



PUNCH TOOL GUIDES



12872-08

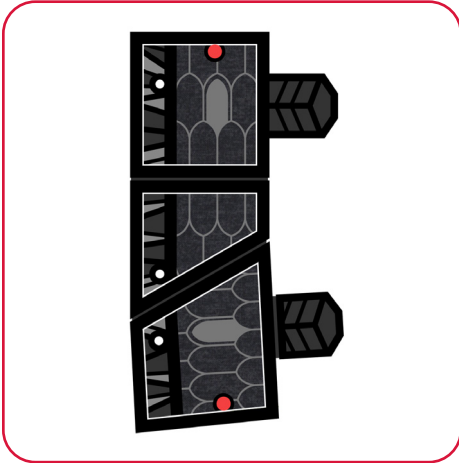

12872-12

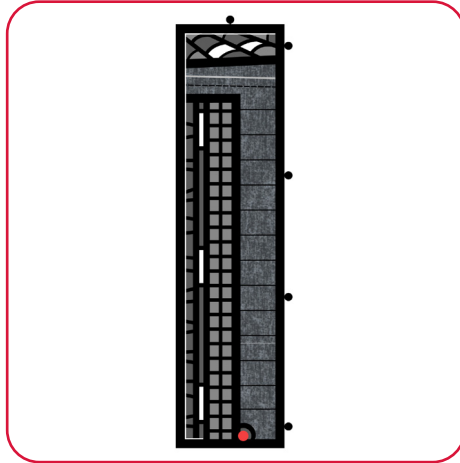

12872-19

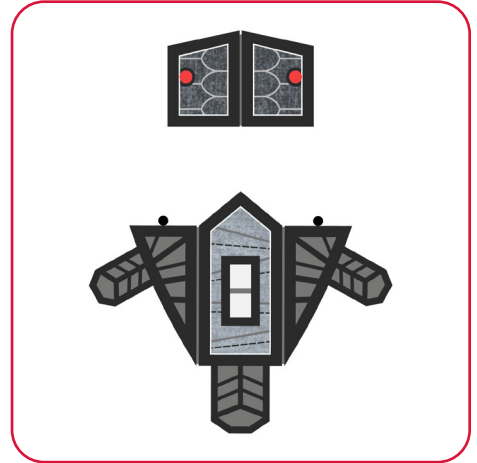

-  = 2 MM
-  = 3 MM
-  = 4 MM

ATTENTION

When printing this document, any page scaling or page fitting options in your print dialog box must be turned OFF or set to NONE so that your files will print out at their actual size. Images not printed at actual size will not function as intended.

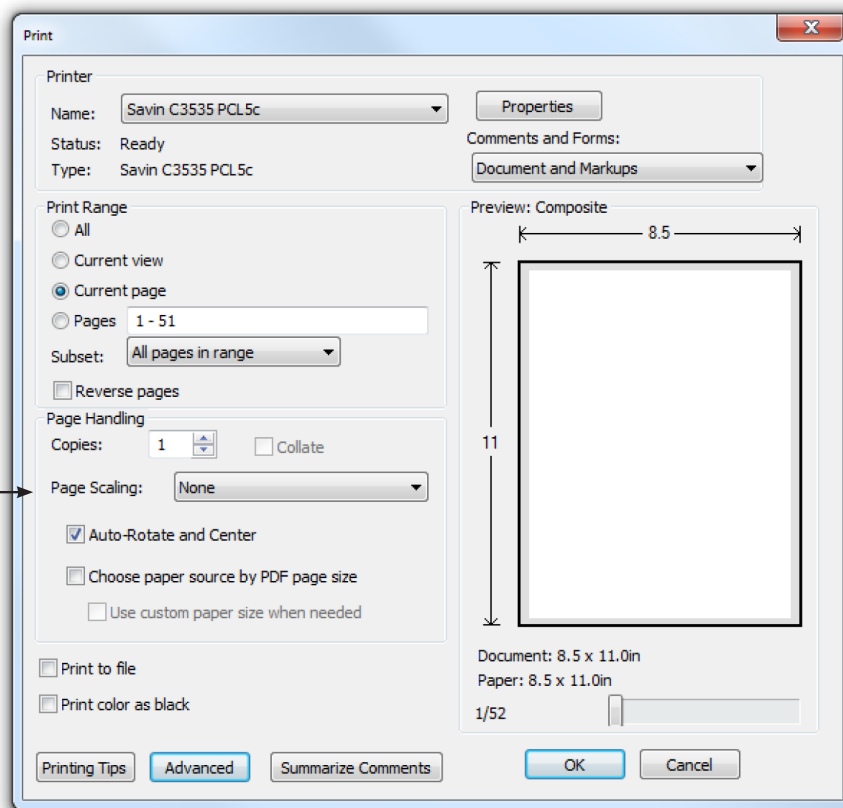

TO SAVE PAPER

Only print the desired image by navigating to the image's page, go to File > Print and select "Current page" in the print dialog box. Repeat for each desired image.

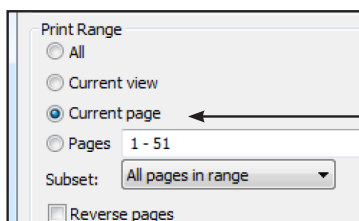

APPLIQUE PATTERNS



Print at 100%. No scaling. This box measures 1" x 1". Use the box as an accuracy guide when printing templates.

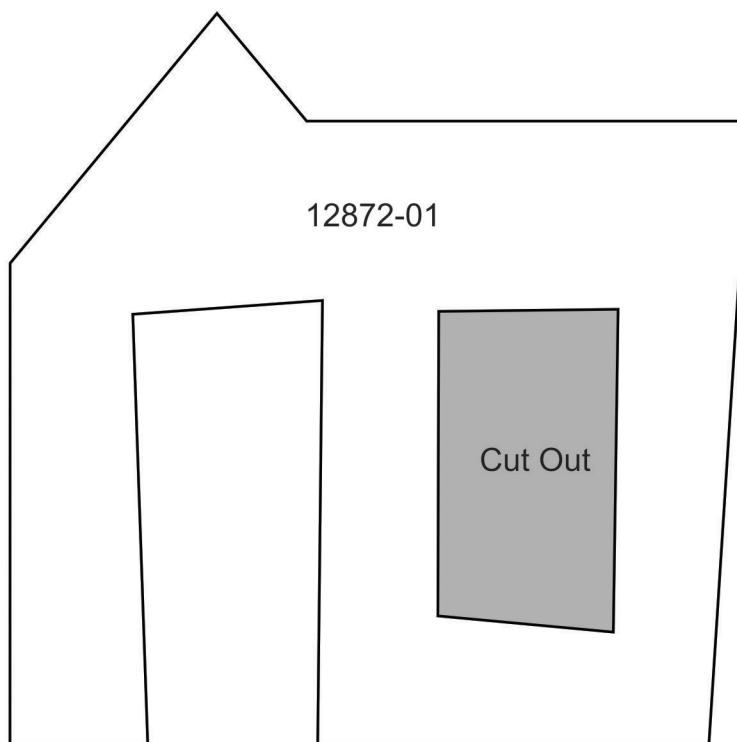
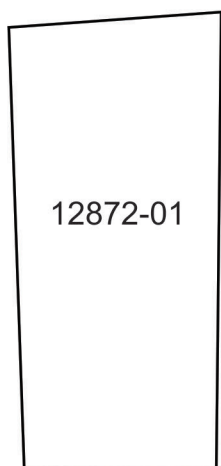
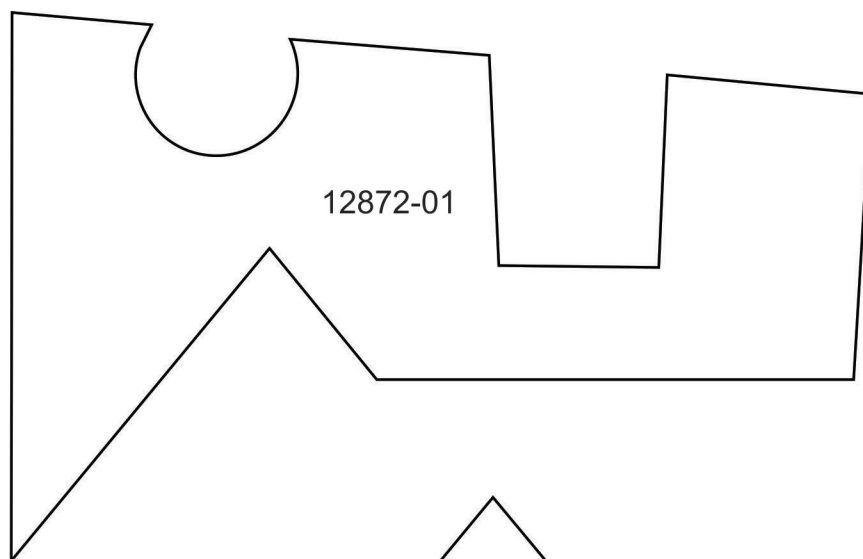

APPLIQUE PATTERNS



Print at 100%. No scaling. This box measures 1" x 1". Use the box as an accuracy guide when printing templates.

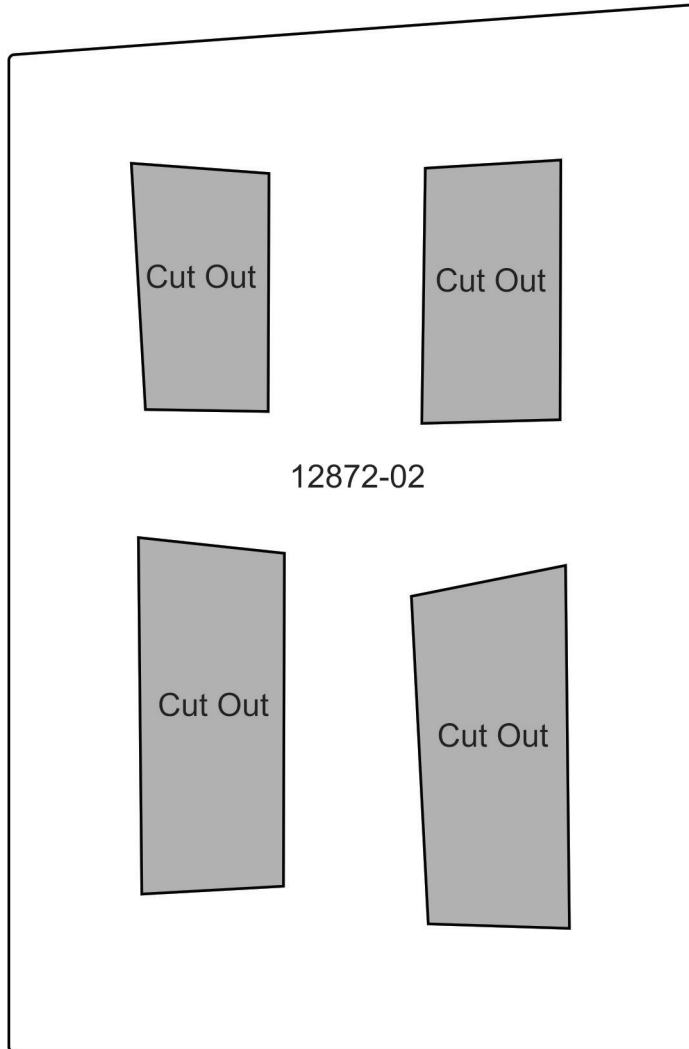

APPLIQUE PATTERNS



Print at 100%. No scaling. This box measures 1" x 1". Use the box as an accuracy guide when printing templates.

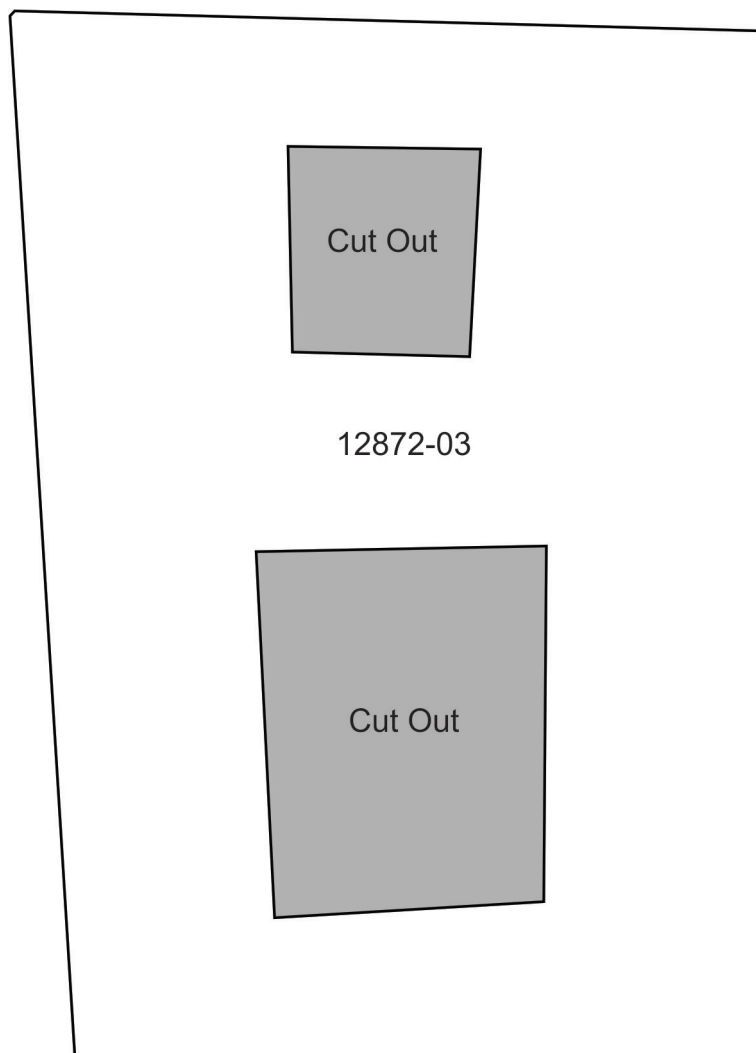

APPLIQUE PATTERNS



Print at 100%. No scaling. This box measures 1" x 1". Use the box as an accuracy guide when printing templates.

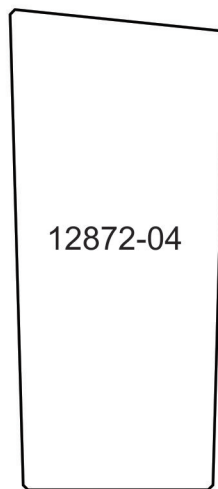
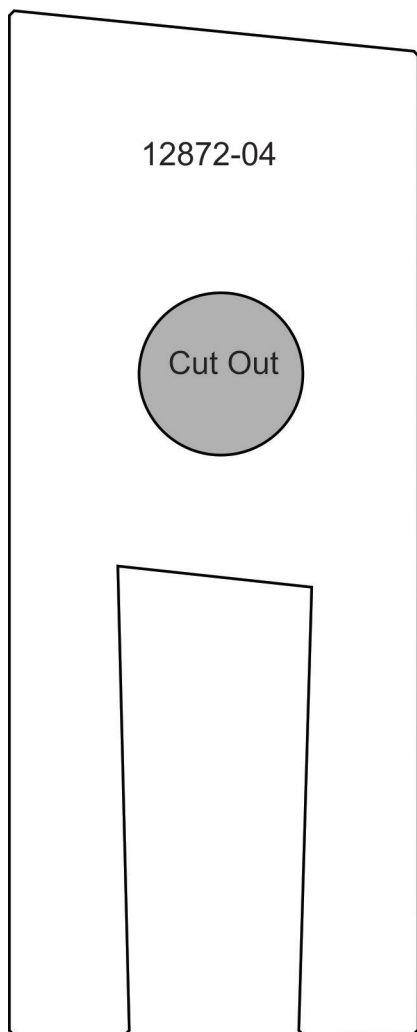

APPLIQUE PATTERNS



Print at 100%. No scaling. This box measures 1" x 1". Use the box as an accuracy guide when printing templates.

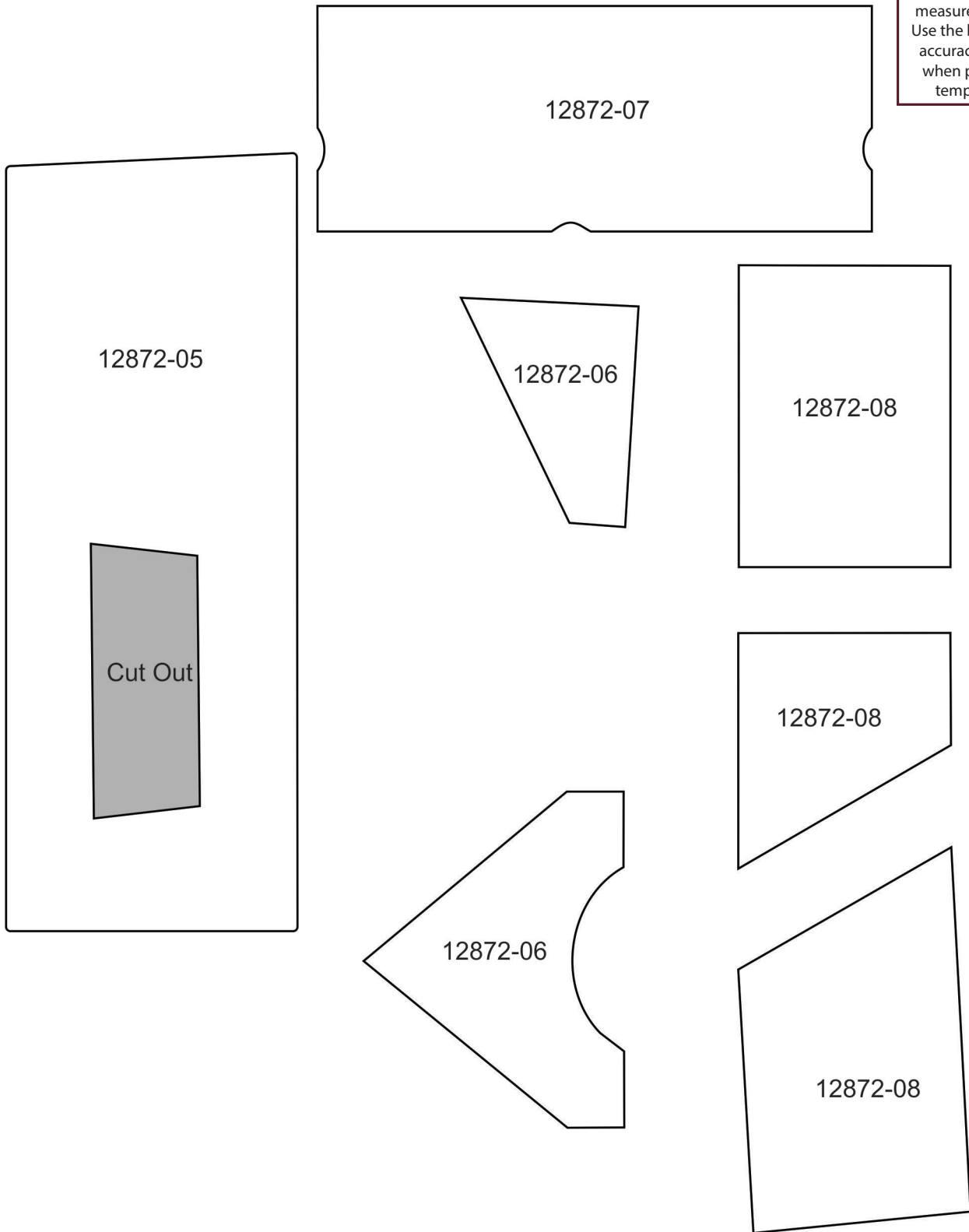

APPLIQUE PATTERNS



Print at 100%. No scaling. This box measures 1" x 1". Use the box as an accuracy guide when printing templates.

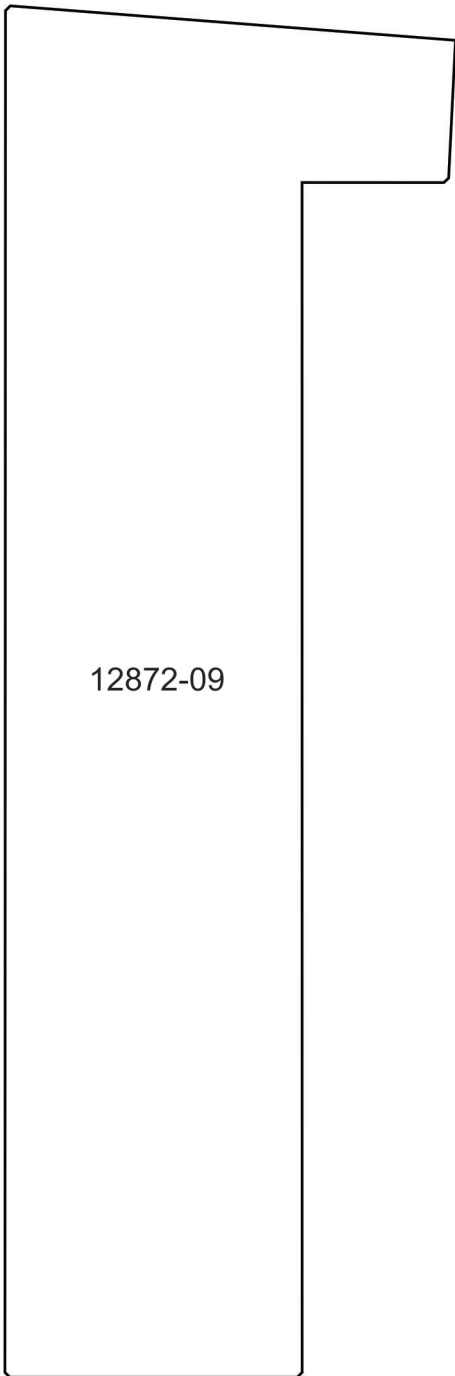

12872-09

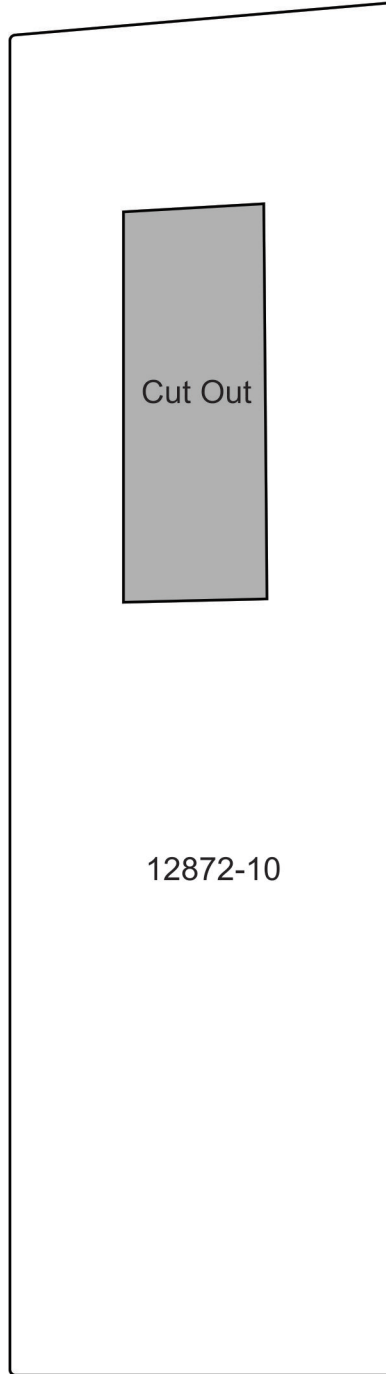

Cut Out

12872-10

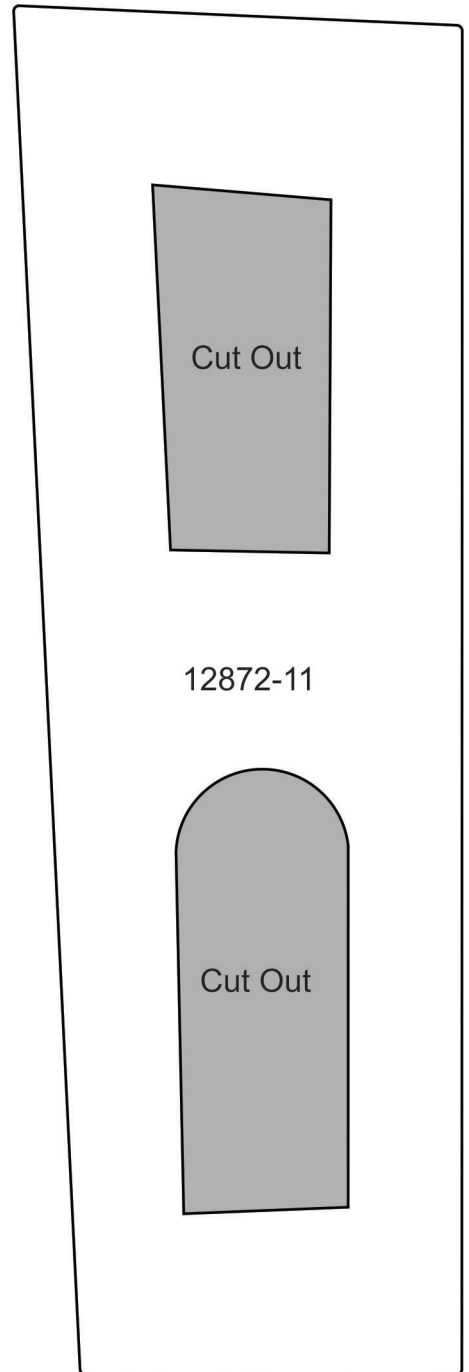

Cut Out

12872-11

Cut Out

APPLIQUE PATTERNS



Print at 100%. No scaling. This box measures 1" x 1". Use the box as an accuracy guide when printing templates.

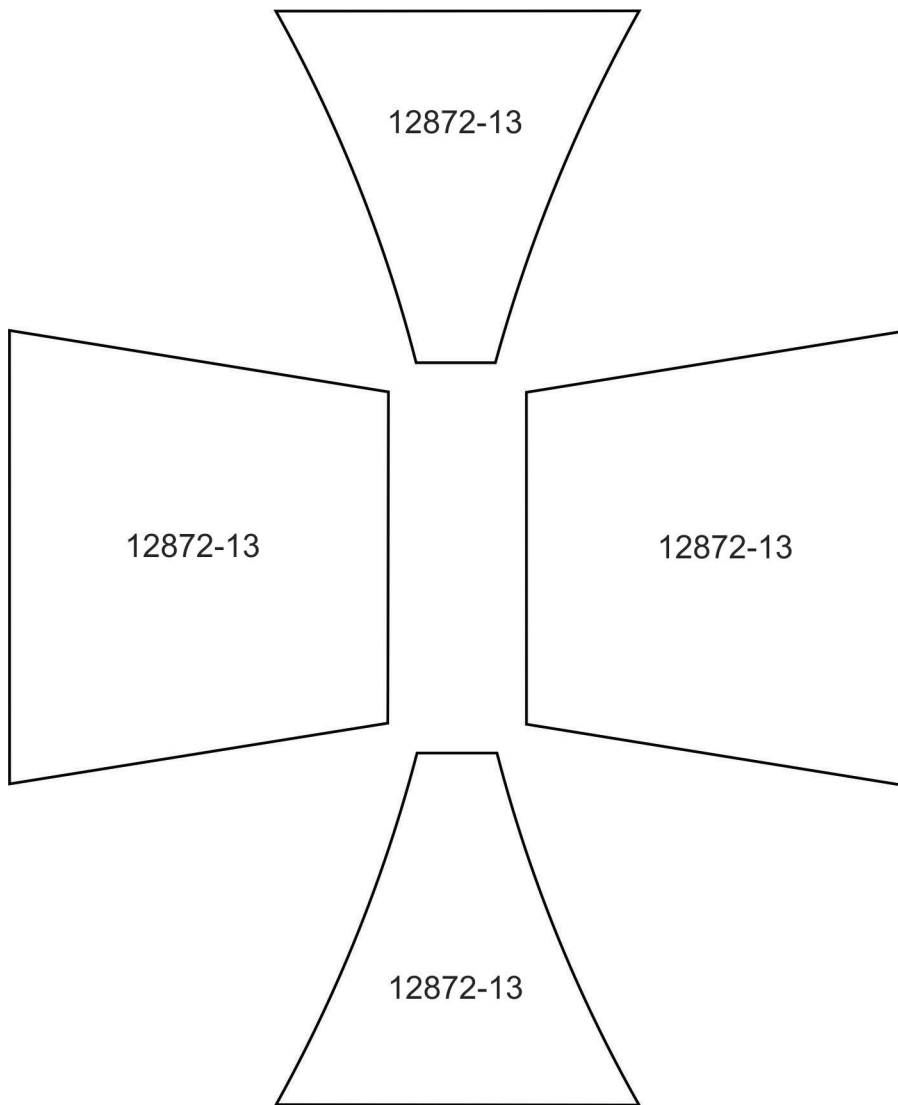
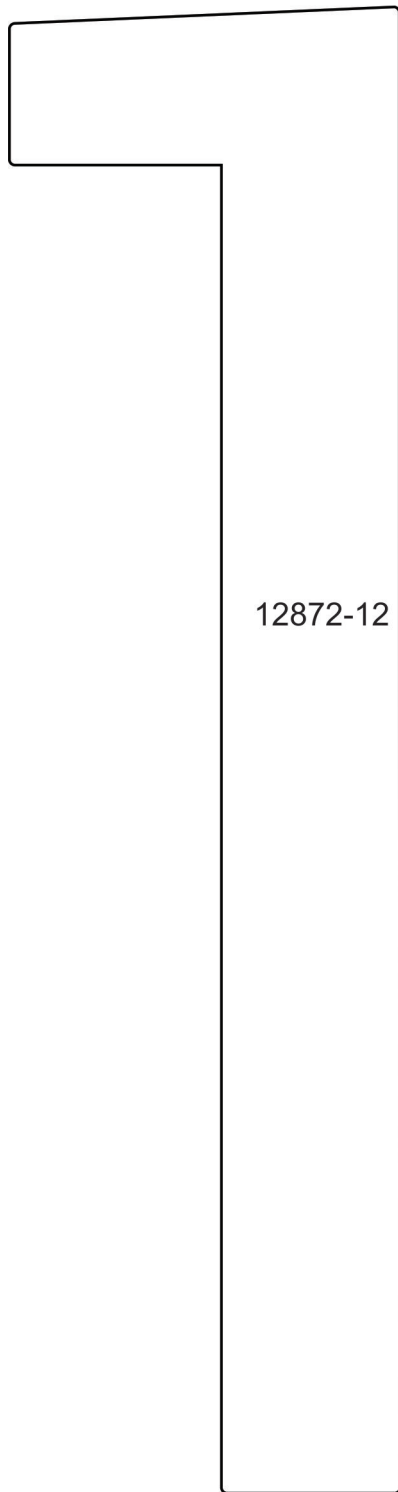

APPLIQUE PATTERNS



Print at 100%. No scaling. This box measures 1" x 1". Use the box as an accuracy guide when printing templates.

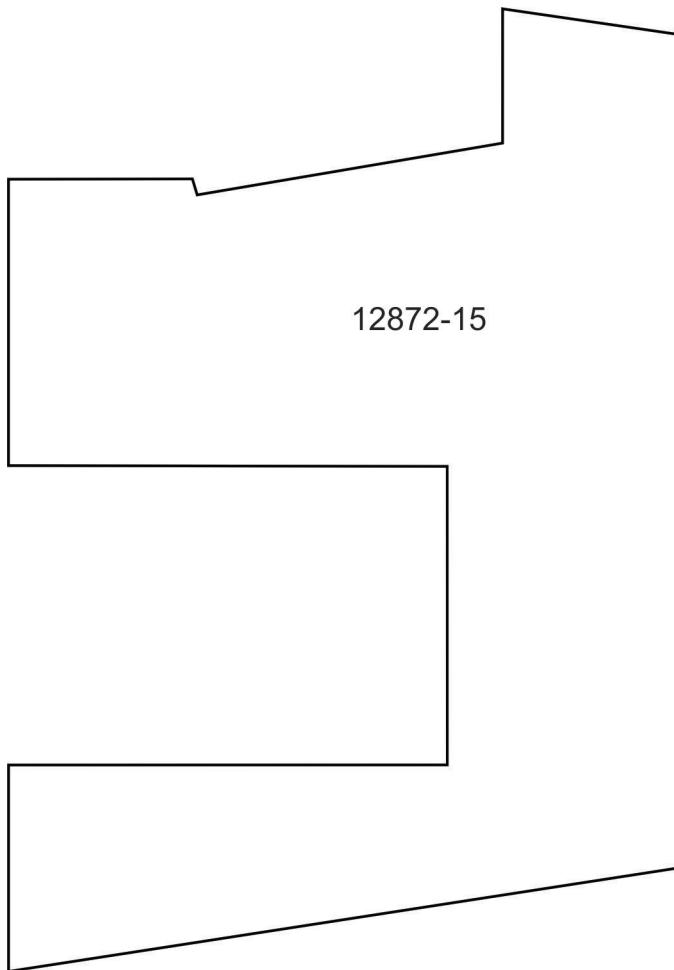

APPLIQUE PATTERNS



Print at 100%. No scaling. This box measures 1" x 1". Use the box as an accuracy guide when printing templates.

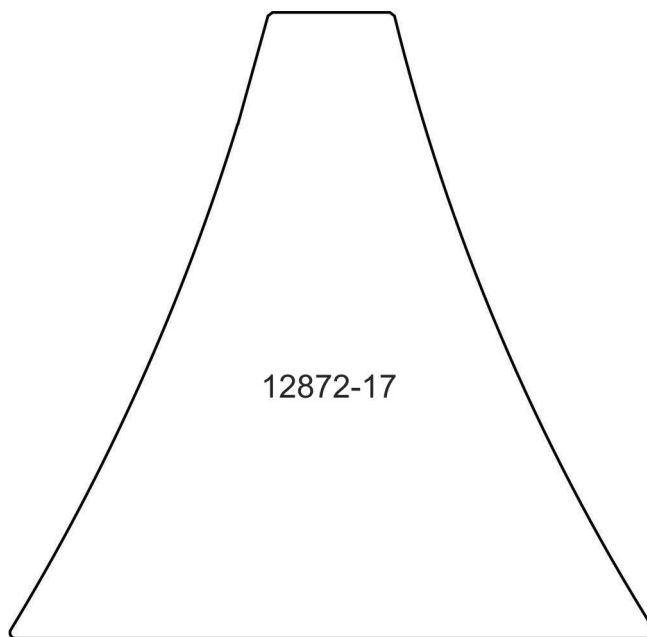
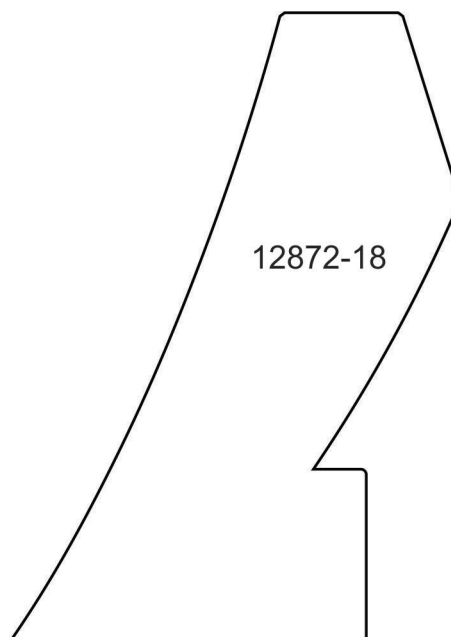
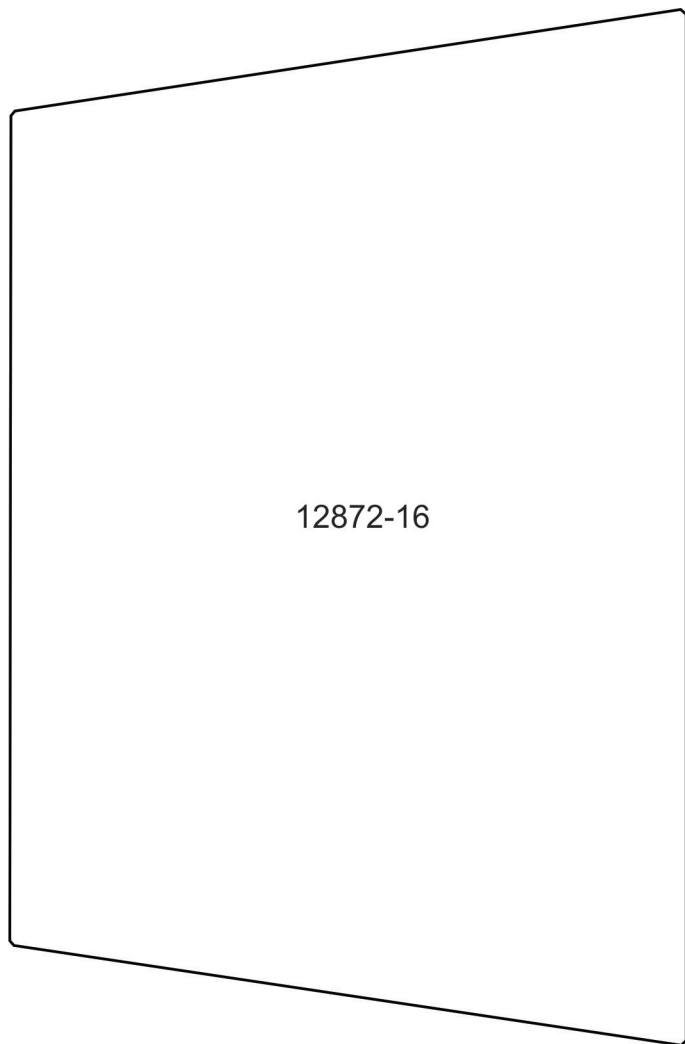

APPLIQUE PATTERNS



Print at 100%. No scaling. This box measures 1" x 1". Use the box as an accuracy guide when printing templates.

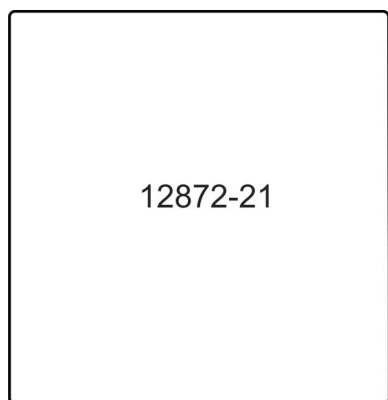
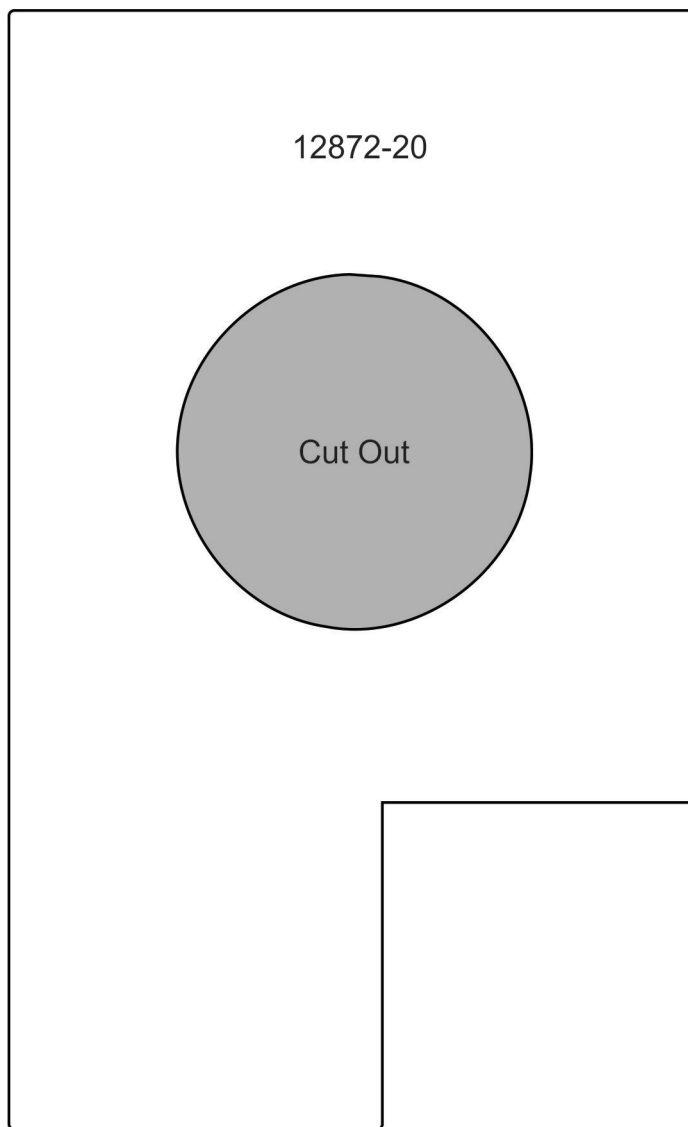
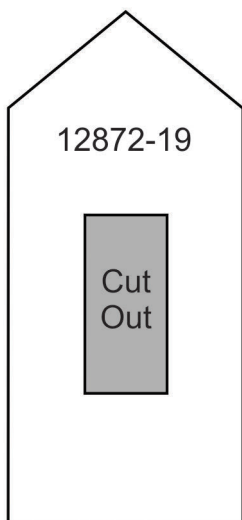
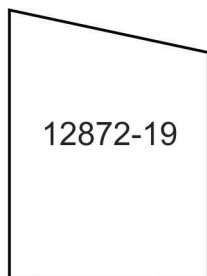
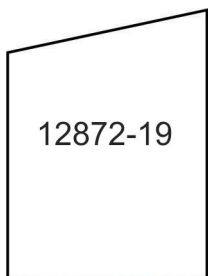

MIRRORED PATTERNS



Print at 100%. No scaling. This box measures 1" x 1". Use the box as an accuracy guide when printing templates.

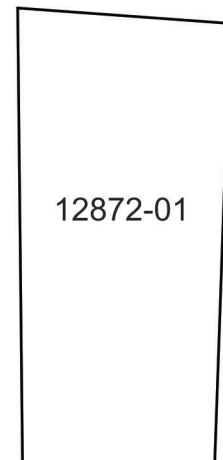
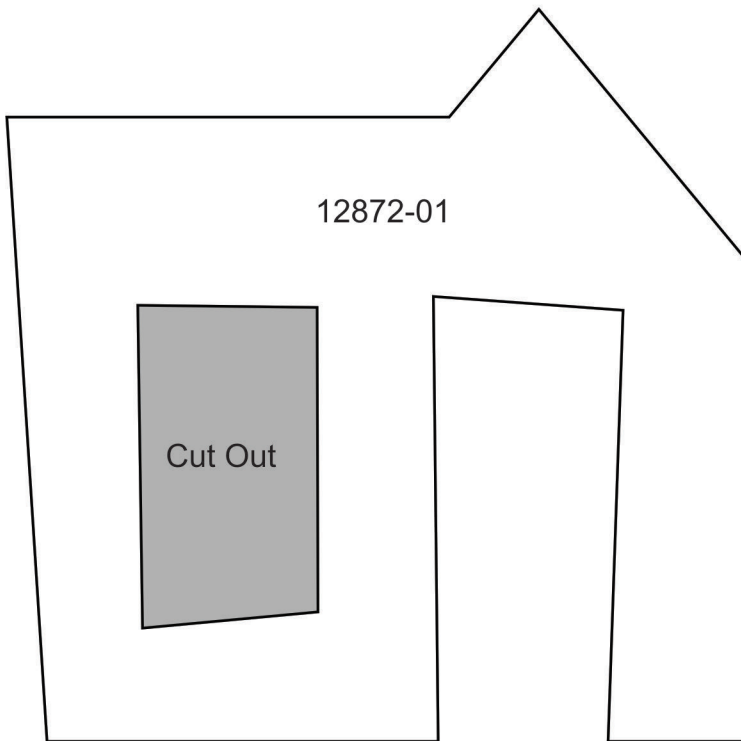
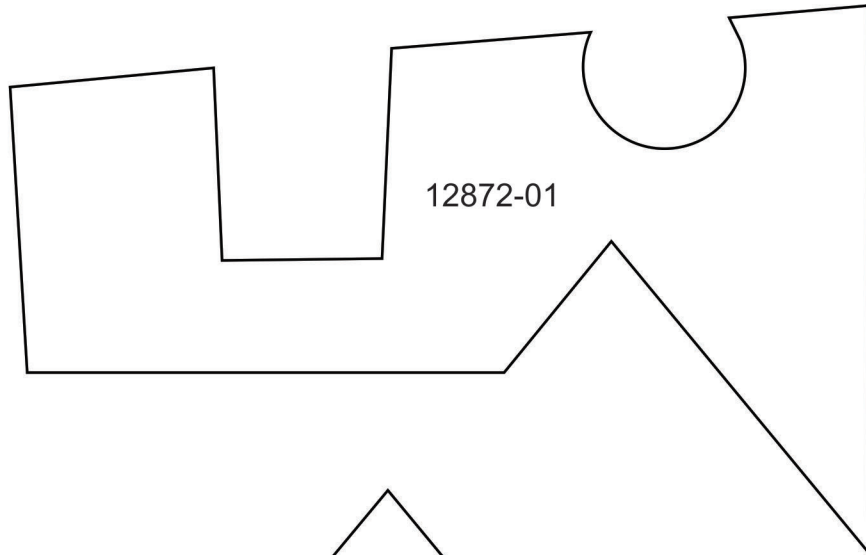

MIRRORED PATTERNS



Print at 100%. No scaling. This box measures 1" x 1". Use the box as an accuracy guide when printing templates.

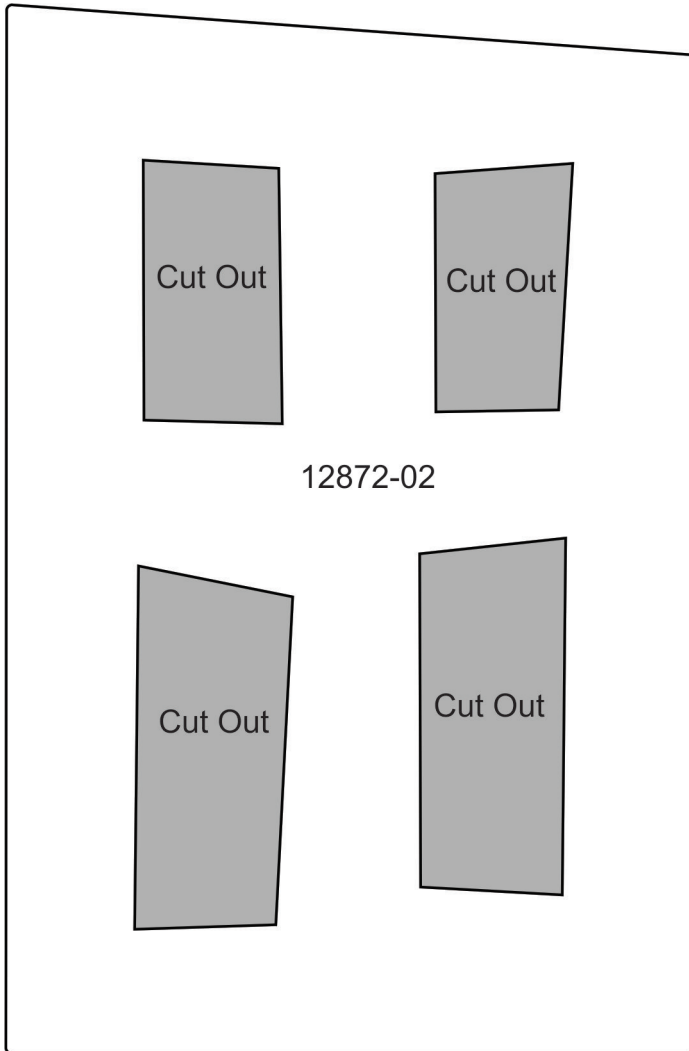

MIRRORED PATTERNS



Print at 100%. No scaling. This box measures 1" x 1". Use the box as an accuracy guide when printing templates.

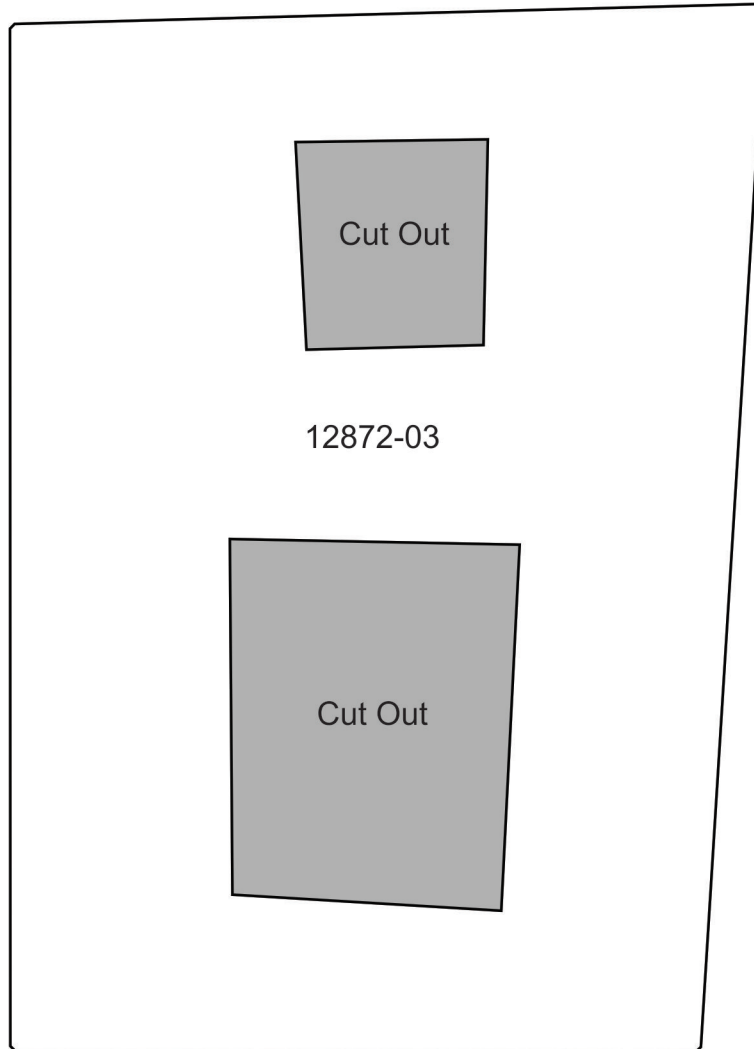

MIRRORED PATTERNS



Print at 100%. No scaling. This box measures 1" x 1". Use the box as an accuracy guide when printing templates.

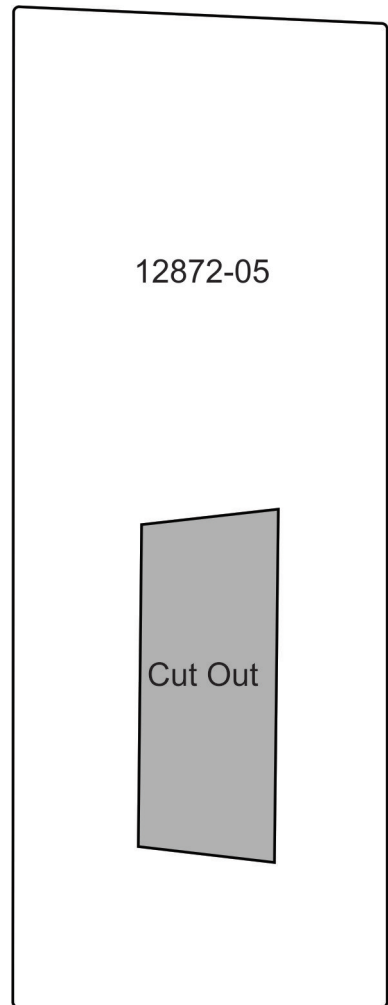
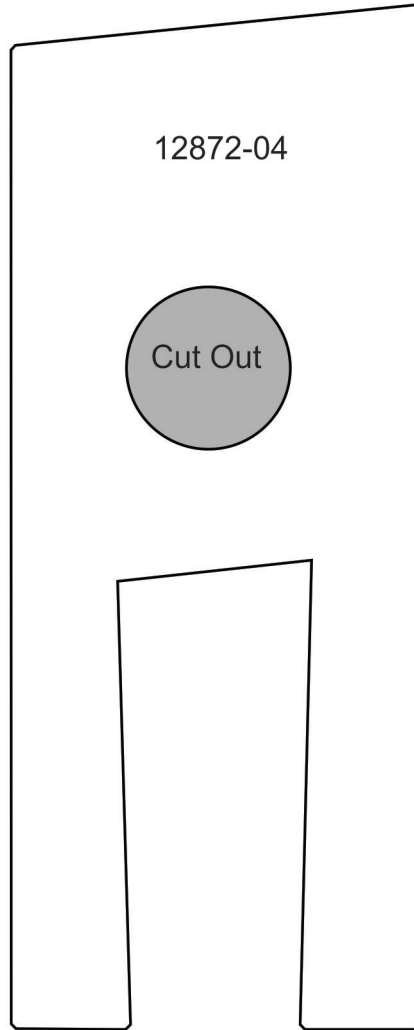
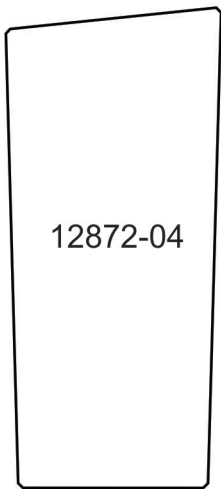

MIRRORED PATTERNS



Print at 100%. No scaling. This box measures 1" x 1". Use the box as an accuracy guide when printing templates.

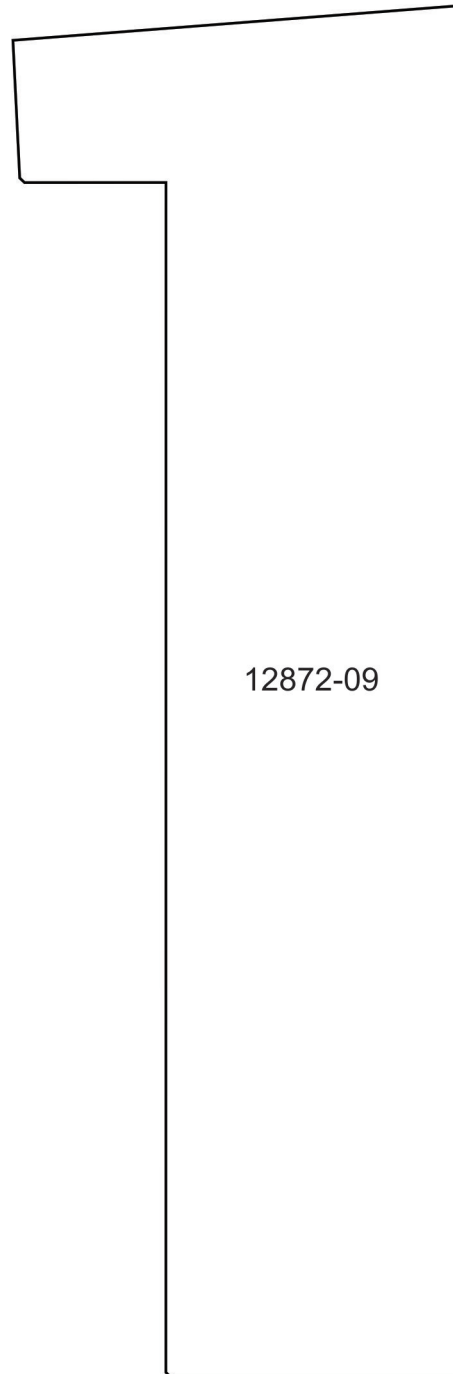
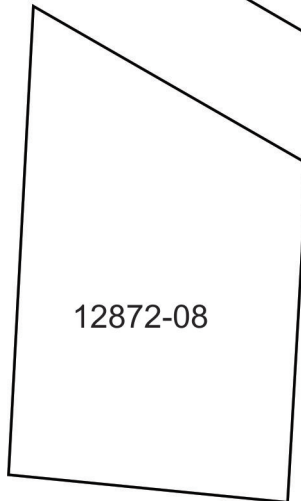
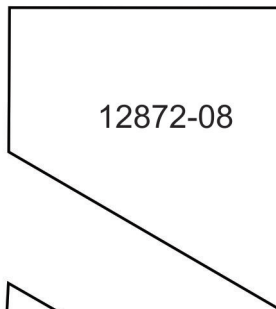
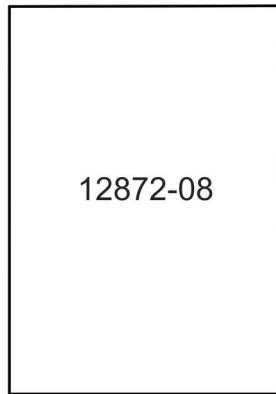
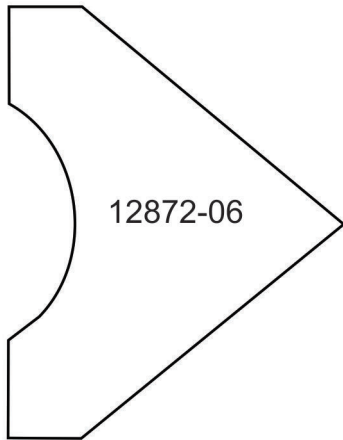
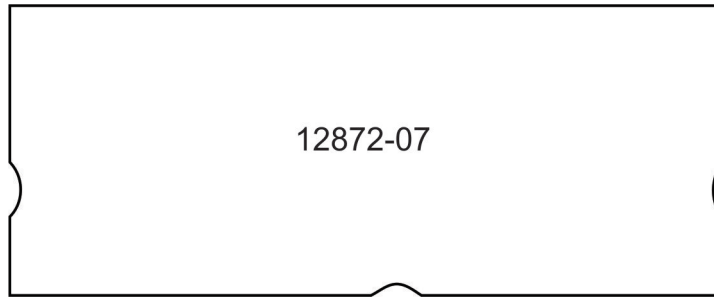
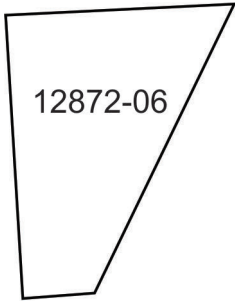

MIRRORED PATTERNS



Print at 100%. No scaling. This box measures 1" x 1". Use the box as an accuracy guide when printing templates.

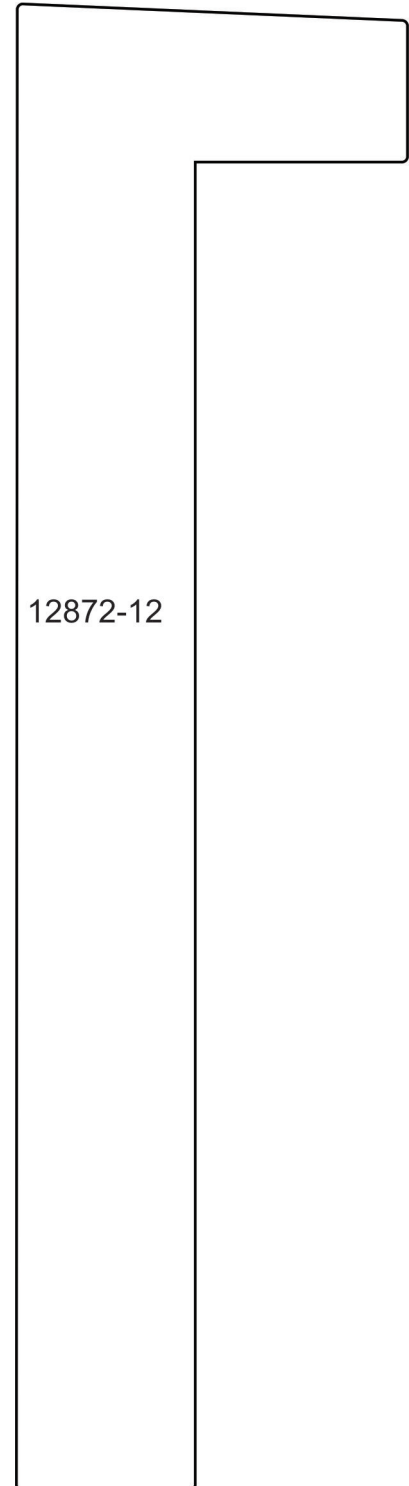
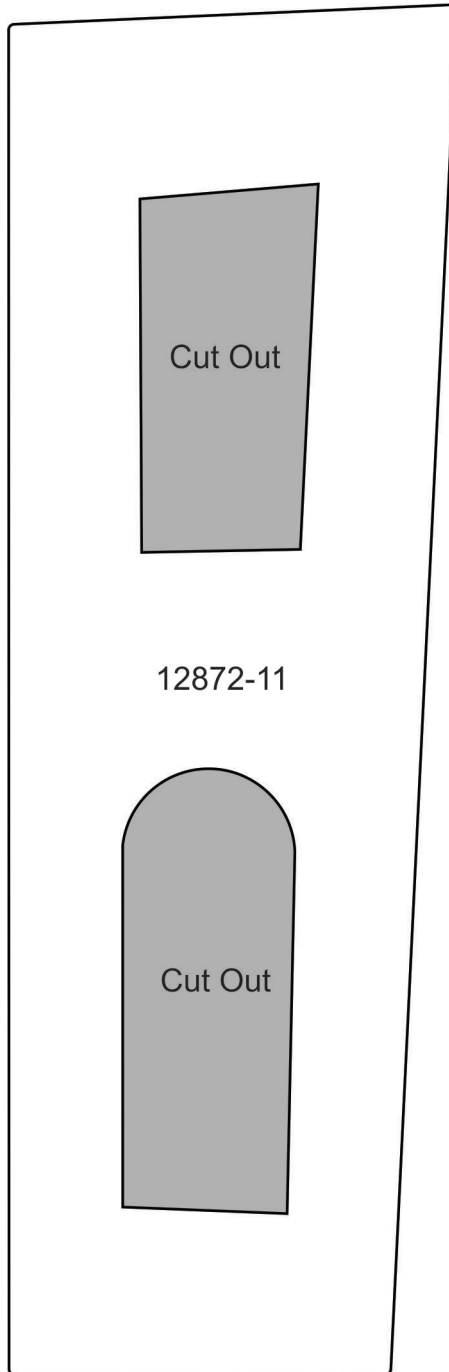
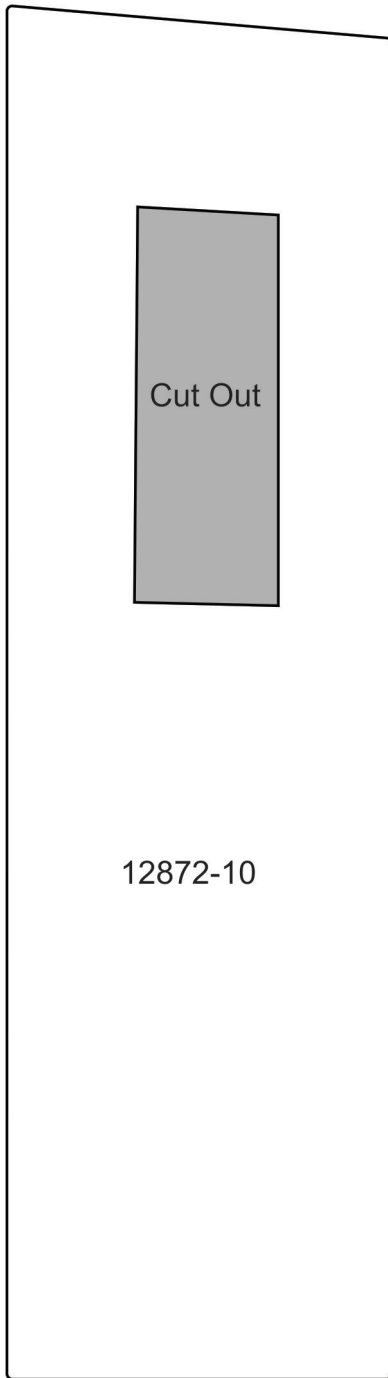

MIRRORED PATTERNS



Print at 100%. No scaling. This box measures 1" x 1". Use the box as an accuracy guide when printing templates.

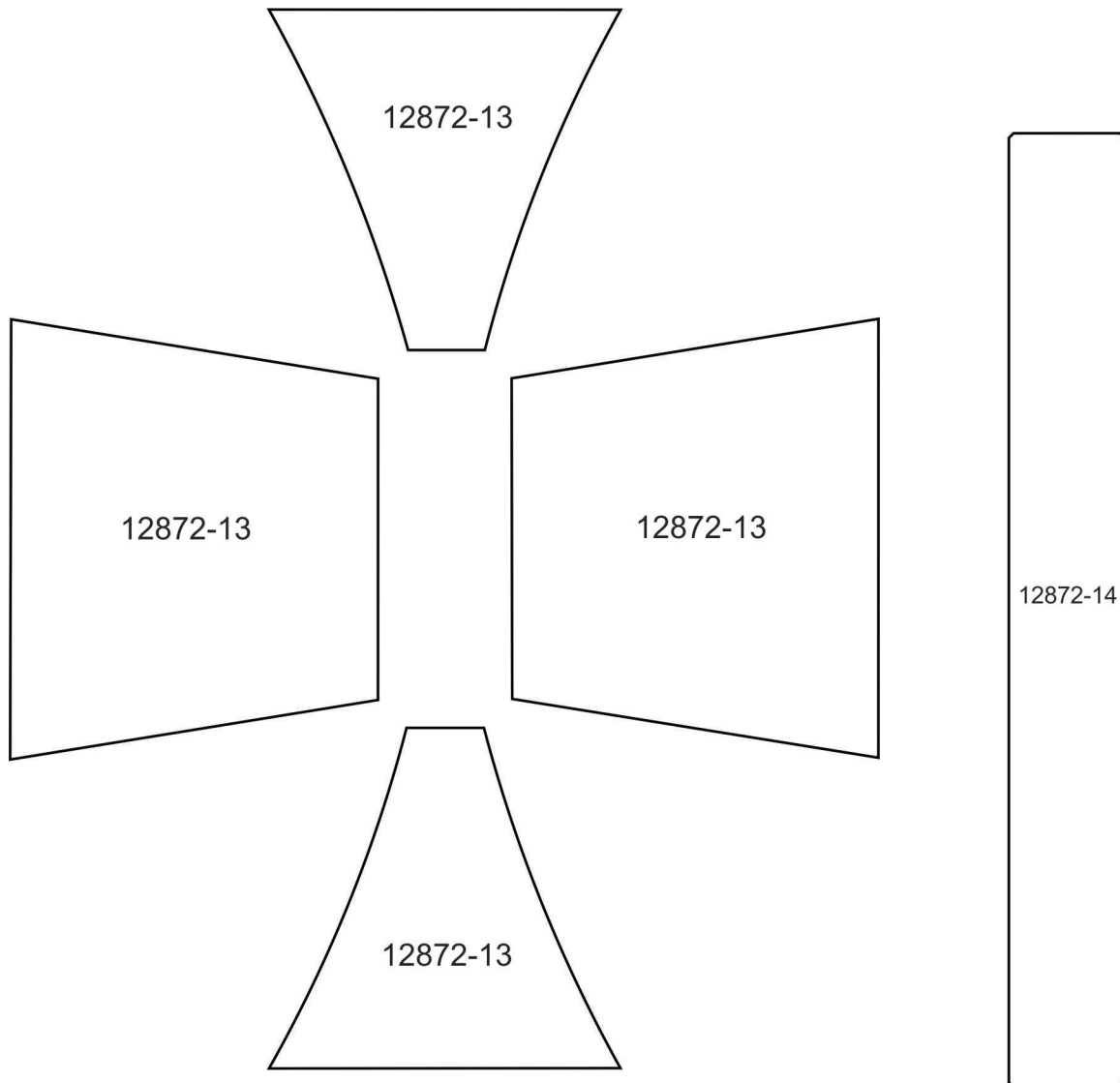

MIRRORED PATTERNS



Print at 100%. No scaling. This box measures 1" x 1". Use the box as an accuracy guide when printing templates.

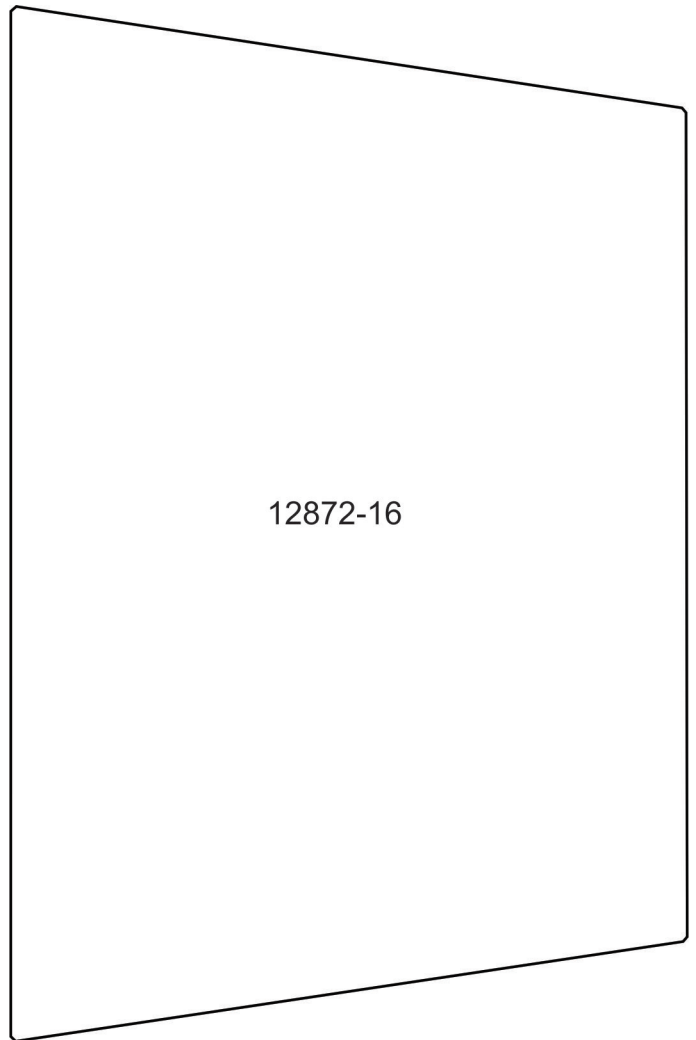
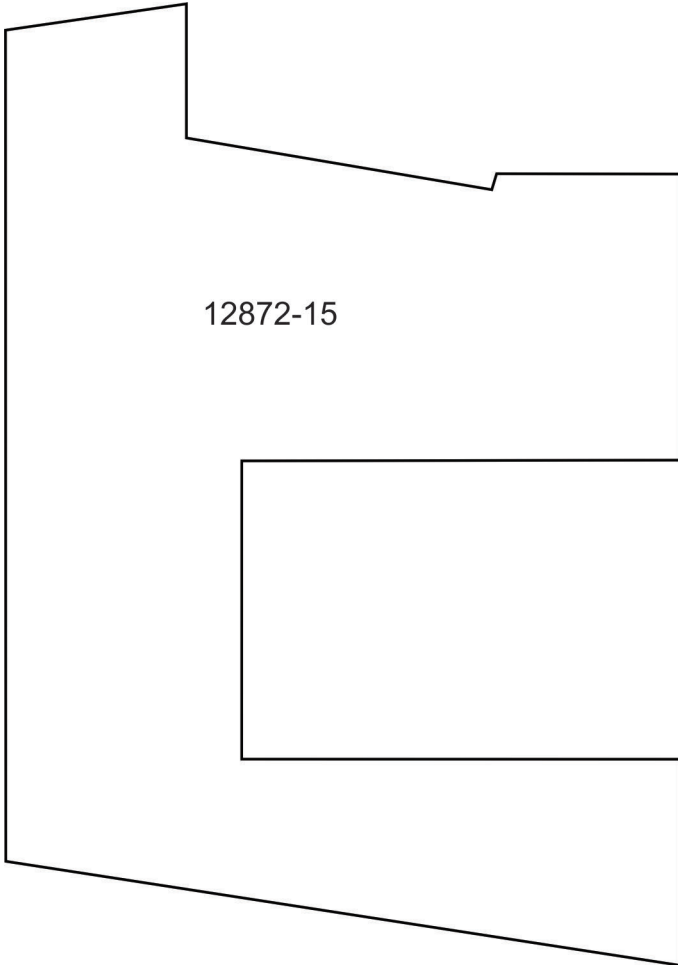

MIRRORED PATTERNS



Print at 100%. No scaling. This box measures 1" x 1". Use the box as an accuracy guide when printing templates.

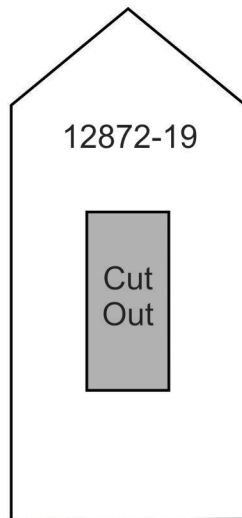
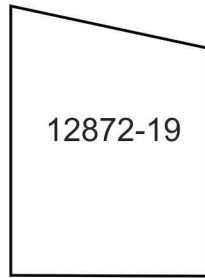
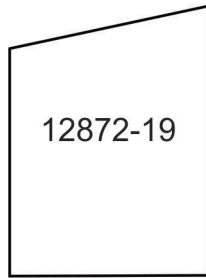
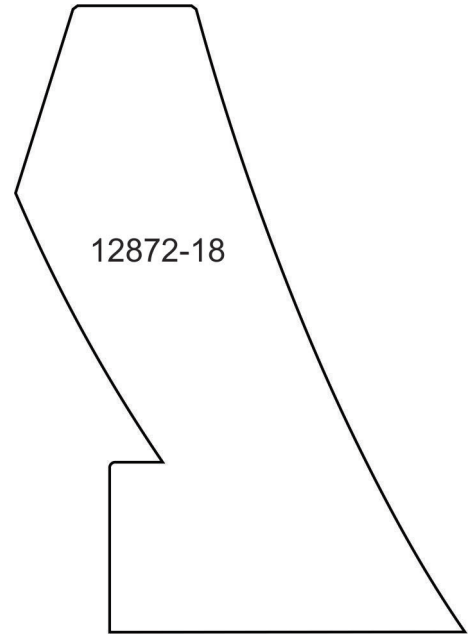
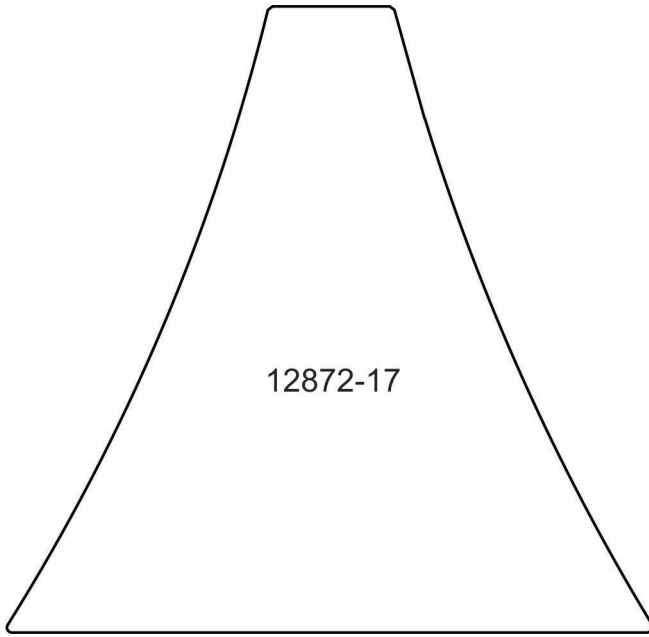

MIRRORED PATTERNS



Print at 100%. No scaling. This box measures 1" x 1". Use the box as an accuracy guide when printing templates.

12872-20

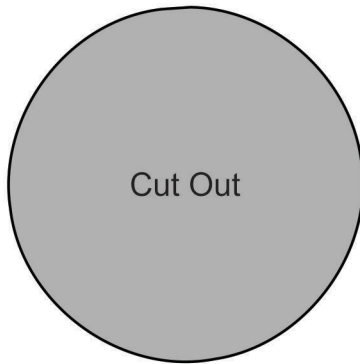

Cut Out

12872-21