

# FREESTANDING HEART GIFT BOXES



3

Designs

Fits hoop sizes 6" x 10" and larger

# THREAD LIST



## Isacord Thread Colors

1840 Corsage  
2520 Garden Rose  
2650 Impatiens

**\* Project instructions included after design list.**

**Note: One spool of 1000 meter thread is adequate for the project unless otherwise noted.**

## Table of Contents

Designs.....	03
Collection Supplies.....	09
Summary .....	10
Embroidery .....	13
Applique Patterns.....	22
Mirrored Patterns.....	28

[Interactive menu](#)  
Click to navigate to section.

Note: Some designs in this collection may have been created using unique special stitches and/or techniques. To preserve design integrity when rescaling or rotating designs in your software, always rescale or rotate designs using the handles directly on-screen.

**\*Fabric Required**

**12899-01 Small Box Left Side**

Size Inches:                      Size mm:                      Stitch Count:  
**4.84 X 2.95 in. 122.8 X 75.0 mm 10023 St.**

- 1. Front and Back Fabric Placement Stitch ..... 2650
- 2. Cut Line and Tackdown ..... 2650
- 3. Cover Stitch ..... 2650

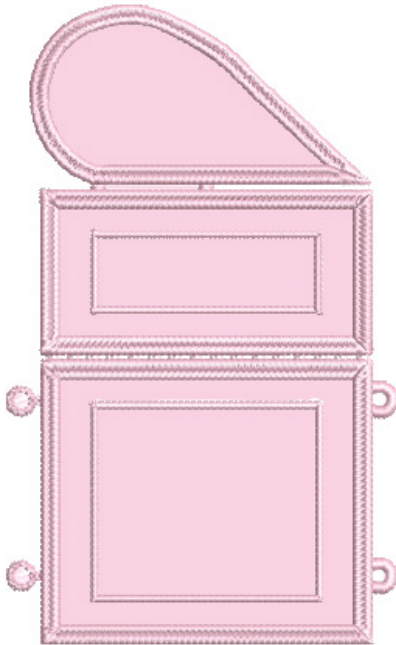

**\*Fabric Required**

**12899-02 Small Box Right Side**

Size Inches:                      Size mm:                      Stitch Count:  
**4.84 X 2.95 in. 122.9 X 75.0 mm 10055 St.**

- 1. Front and Back Fabric Placement Stitch ..... 2650
- 2. Cut Line and Tackdown ..... 2650
- 3. Cover Stitch ..... 2650

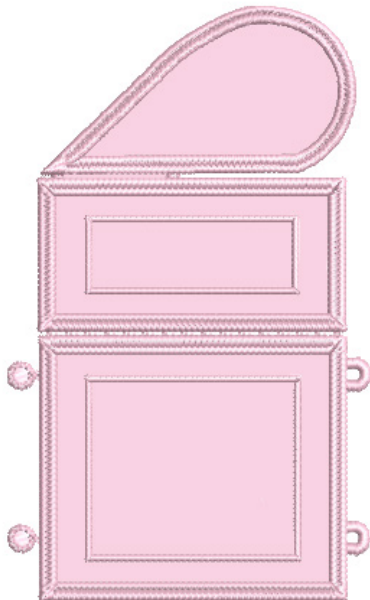

Note: Some designs in this collection may have been created using unique special stitches and/or techniques. To preserve design integrity when rescaling or rotating designs in your software, always rescale or rotate designs using the handles directly on-screen.

**\*Fabric Required**

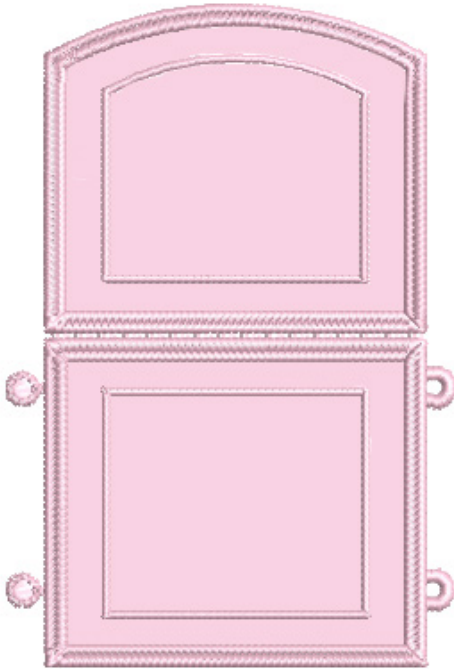

### 12899-03 Small Box Front & Back Sides

Size Inches:                      Size mm:                      Stitch Count:  
**4.36 X 2.95 in. 110.8 X 75.0 mm 8688 St.**

-  1. Front and Back Fabric Placement Stitch ..... 2650
-  2. Cut Line and Tackdown ..... 2650
-  3. Cover Stitch ..... 2650

**\*Fabric Required**



### 12899-04 Small Box Base

Size Inches:                      Size mm:                      Stitch Count:  
**2.49 X 2.49 in. 63.3 X 63.3 mm 3149 St.**

-  1. Front and Back Fabric Placement Stitch ..... 2650
-  2. Cut Line and Tackdown ..... 2650
-  3. Cover Stitch ..... 2650

Note: Some designs in this collection may have been created using unique special stitches and/or techniques. To preserve design integrity when rescaling or rotating designs in your software, always rescale or rotate designs using the handles directly on-screen.

**\*Fabric Required**

### 12899-05 Medium Box Left Side

Size Inches:                      Size mm:                      Stitch Count:  
**6.12 X 3.60 in. 155.5 X 91.3 mm 12548 St.**

-  1. Front and Back Fabric Placement Stitch ..... 1840
-  2. Cut Line and Tackdown ..... 1840
-  3. Cover Stitch ..... 1840

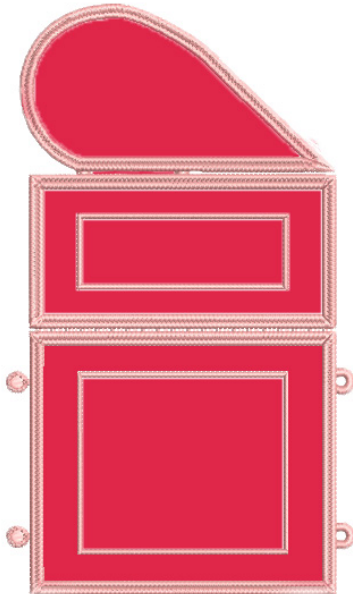

**\*Fabric Required**

### 12899-06 Medium Box Right Side

Size Inches:                      Size mm:                      Stitch Count:  
**6.13 X 3.59 in. 155.6 X 91.3 mm 12544 St.**

-  1. Front and Back Fabric Placement Stitch ..... 1840
-  2. Cut Line and Tackdown ..... 1840
-  3. Cover Stitch ..... 1840

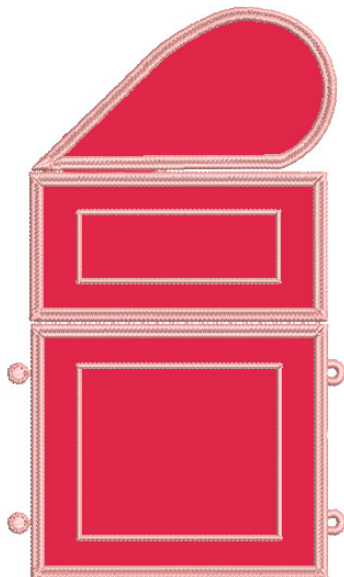

Note: Some designs in this collection may have been created using unique special stitches and/or techniques. To preserve design integrity when rescaling or rotating designs in your software, always rescale or rotate designs using the handles directly on-screen.

**\*Fabric Required**

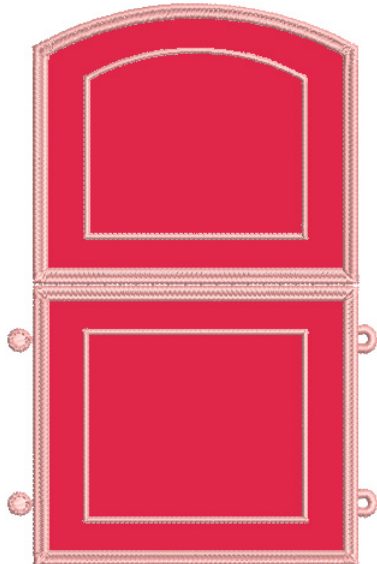

### 12899-07 Medium Box Front & Back Sides

Size Inches:                      Size mm:                      Stitch Count:  
**5.49 X 3.59 in. 139.3 X 91.2 mm 10769 St.**

- 1. Front and Back Fabric Placement Stitch ..... 1840
- 2. Cut Line and Tackdown ..... 1840
- 3. Cover Stitch ..... 1840

**\*Fabric Required**



### 12899-08 Medium Box Base

Size Inches:                      Size mm:                      Stitch Count:  
**3.15 X 3.15 in. 80.1 X 80.1 mm 3975 St.**

- 1. Front and Back Fabric Placement Stitch ..... 1840
- 2. Cut Line and Tackdown ..... 1840
- 3. Cover Stitch ..... 1840

Note: Some designs in this collection may have been created using unique special stitches and/or techniques. To preserve design integrity when rescaling or rotating designs in your software, always rescale or rotate designs using the handles directly on-screen.

**\*Fabric Required**

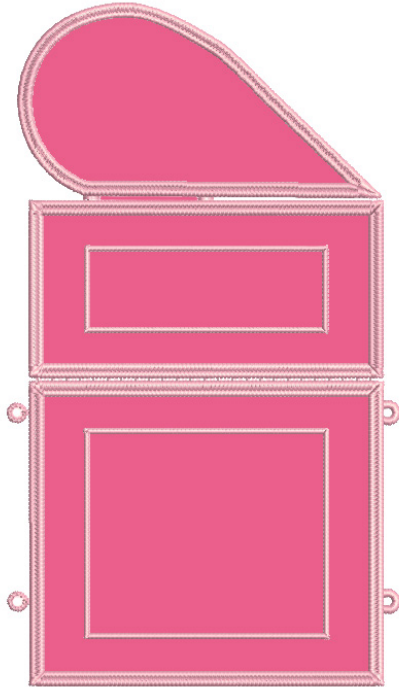

**12899-09 Large Box Left Side**

Size Inches:                      Size mm:                      Stitch Count:  
**7.78 X 4.46 in. 197.7 X 113.3 mm 15715 St.**

- 1. Front and Back Fabric Placement Stitch ..... 2520
- 2. Cut Line and Tackdown ..... 2520
- 3. Cover Stitch..... 2520

**\*Fabric Required**

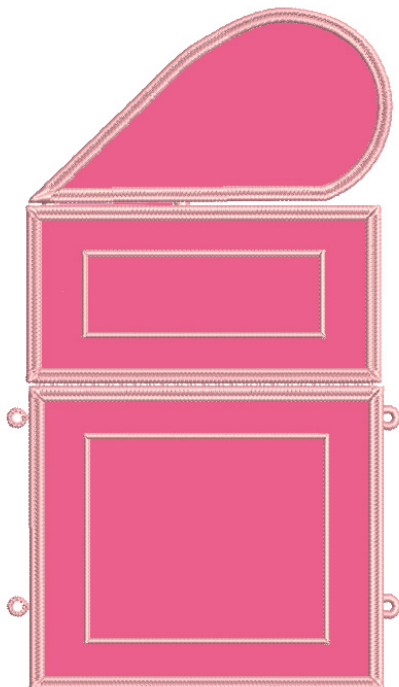

**12899-10 Large Box Right Side**

Size Inches:                      Size mm:                      Stitch Count:  
**7.78 X 4.46 in. 197.7 X 113.3 mm 15766 St.**

- 1. Front and Back Fabric Placement Stitch ..... 2520
- 2. Cut Line and Tackdown ..... 2520
- 3. Cover Stitch..... 2520

Note: Some designs in this collection may have been created using unique special stitches and/or techniques. To preserve design integrity when rescaling or rotating designs in your software, always rescale or rotate designs using the handles directly on-screen.

**\*Fabric Required**

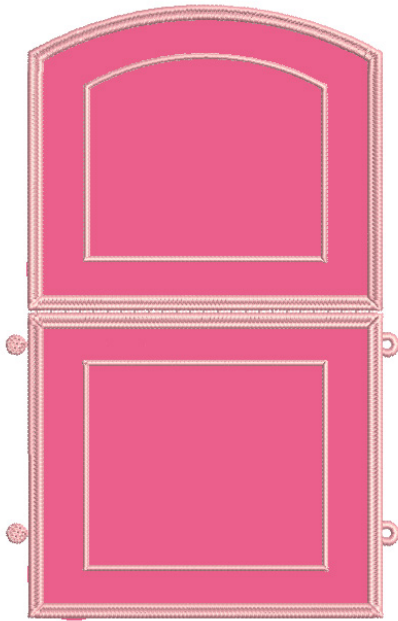

**12899-11 Large Box Front & Back Sides**

Size Inches:                      Size mm:                      Stitch Count:  
**6.99 X 4.46 in. 177.4 X 113.3 mm 13507 St.**

- 1. Front and Back Fabric Placement Stitch ..... 2520
- 2. Cut Line and Tackdown ..... 2520
- 3. Cover Stitch ..... 2520

**\*Fabric Required**



**12899-12 Large Box Base**

Size Inches:                      Size mm:                      Stitch Count:  
**4.01 X 4.01 in. 101.9 X 101.9 mm 5089 St.**

- 1. Front and Back Fabric Placement Stitch ..... 2520
- 2. Cut Line and Tackdown ..... 2520
- 3. Cover Stitch ..... 2520



# COLLECTION SUPPLIES



## Stabilizers

- OESD AquaMesh WashAway
- OESD BadgeMaster WashAway
- OESD StabilStick CutAway

## Fabrics/Textiles

- Pink quilter's cotton
- Red quilter's cotton
- Magenta quilter's cotton
- See Summary for measurements.
- Note: Fabric sizes are estimates and may result in overage.

## Notions & Tools

- OESD Alligator Clamps
- OESD Button Clips
- OESD Expert Embroidery Tape WashAway
- OESD Perfect Embroidery Press Cloth
- Embroidery Needle Sharp 75/11

## Isacord Thread Colors

- Per thread chart
- Match the bobbin thread to the upper thread.

# SUMMARY



Completed Size: 2 ¼" H x 3" W x 3" D

## Small Box

Designs 12899-01 & 12899-02

4 Pink quilter's cotton 6" x 3 ½"

Designs 12899-03

4 Pink quilter's cotton 5 ¼" x 3 ½"

Designs 12899-04

2 Pink quilter's cotton 3 ½" x 3 ½"

12899-01

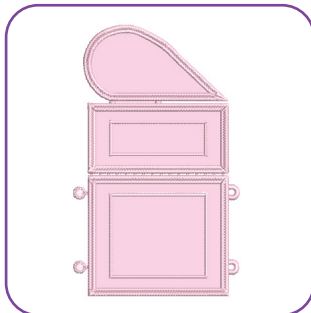

Requires 1 Design

12899-02

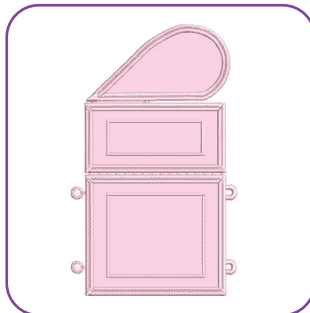

Requires 1 Design

12899-03

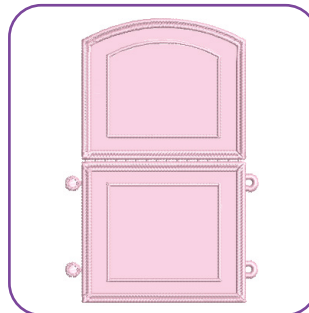

Requires 2 Designs

12899-04

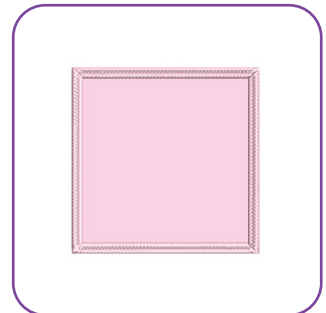

Requires 1 Design

# SUMMARY



Completed Size: 2 ¼" H x 3" W x 3" D

## Small Box

Designs 12899-05 & 12899-06  
4 Red quilter's cotton 7" x 4 ¼"

Designs 12899-07  
4 Red quilter's cotton 6 ½" x 4"

Designs 12899-08  
2 Red quilter's cotton 4" x 4"

12899-05

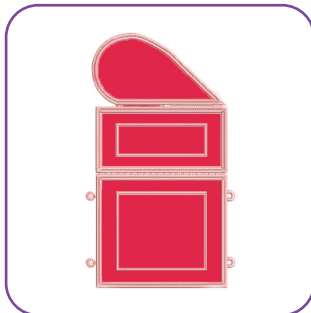

Requires 1 Design

12899-06

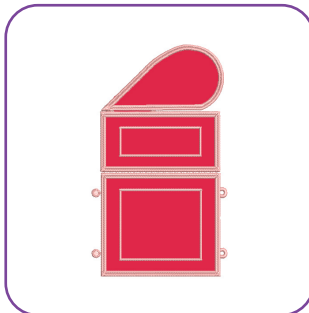

Requires 1 Design

12899-07

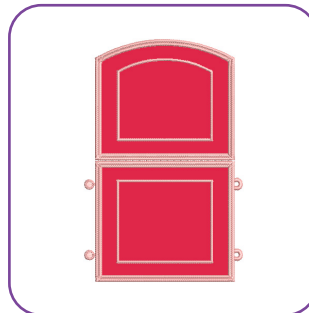

Requires 2 Designs

12899-08

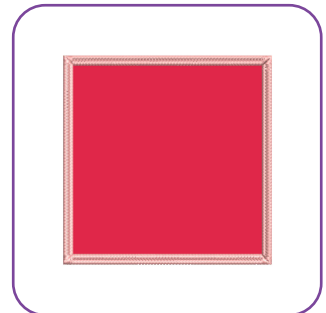

Requires 1 Design

# SUMMARY

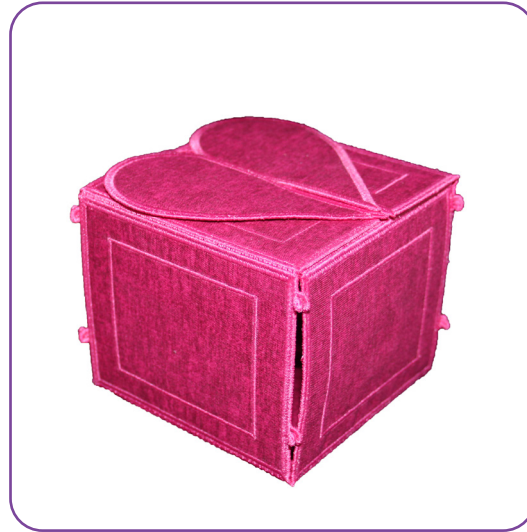

Completed Size: 3 1/2" H x 4 1/4" W x 4 1/4" D

## Large Box

Designs 12899-09 & 12899-10  
4 Magenta quilter's cotton 9" x 5"

Designs 12899-11  
4 Magenta quilter's cotton 8" x 5"

Designs 12899-12  
2 Magenta quilter's cotton 5" x 5"

12899-09



Requires 1 Design

12899-10



Requires 1 Design

12899-11

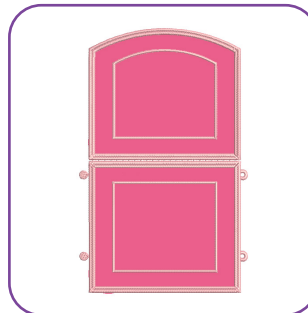

Requires 2 Designs

12899-12

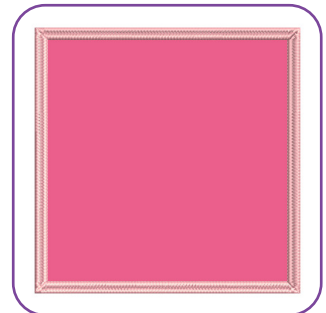

Requires 1 Design

## Notes

The freestanding applique instructions, included in the collection, are general instructions. For demonstration purposes, a sample design that best demonstrates the technique is shown. Fabric and thread requirements will vary by design, but the general technique is the same.

All designs are stitched with matching thread, top and bobbin.

Note: Some thread colors in instructions have been changed or digitally enhanced for better visibility.

## STEP 1

- Hoop one layer of AquaMesh and one layer of BadgeMaster for all designs.



## STEP 2

- Adhere one layer of StabilStick CutAway to the wrong side of all applique fabrics, to provide stiffness to the finished structure.
- Note: The structure interior is finished with an interior lining fabric. Since this is a double-sided applique only 1 layer of StabilStick per applique fabric is needed to provide stiffness to the structure.

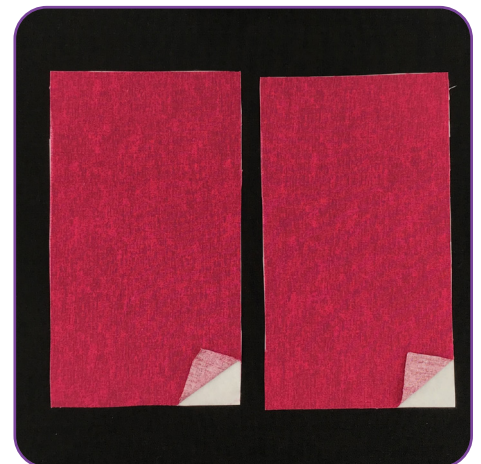

# EMBROIDERY



## STEP 3

- Load selected design into the machine.
- Example design is 12899-09.
- Thread the machine per the thread chart.
- Stitch Machine Step 1, Front and Back Fabric Placement Stitch.

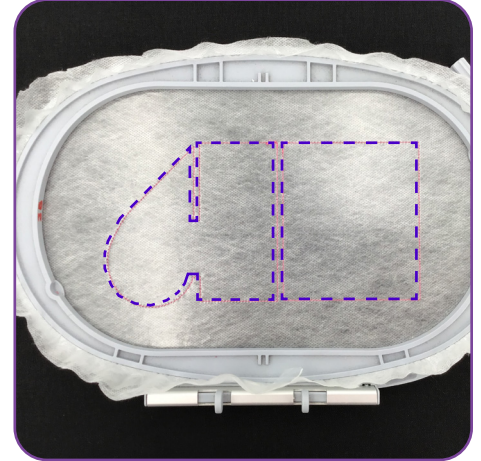

## STEP 4

- Remove the hoop from the machine, but NOT the project from the hoop.
- Lay the hoop on a flat surface.
- Completely cover the placement stitch with the prepared fabric.
- Tape in place to secure.

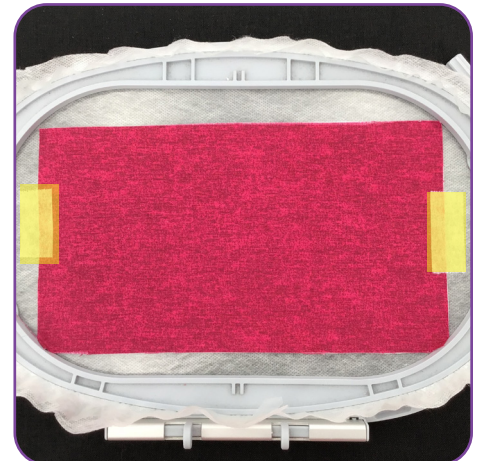

## STEP 5

- Turn the hoop over and place the prepared fabric, right side up, completely covering the placement stitch.
- Carefully tape to secure. Avoid pushing too hard on the stabilizer to prevent it from dislodging from the hoop.



# EMBROIDERY



## STEP 6

- Return the hoop to the machine.
- Stitch Machine Step 2, Cut Line and Tackdown.

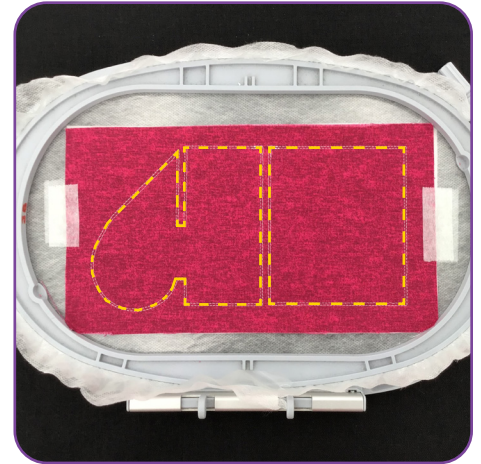

## STEP 7

- Remove the hoop from the machine, but NOT the project from the hoop.
- Trim the excess fabric as close to the cut line as possible. If the outermost stitches (cut line) are cut, the inner stitches (tackdown) will still hold the applique in place.
- Tip: If the AquaMesh is cut or a hole is created while trimming the fabric, use OESD Expert Embroidery Tape WashAway as a patch.



## STEP 8

- Turn the hoop over and trim the excess fabric as close to the cut line as possible. If the outermost stitches (cut line) are cut, the inner stitches (tackdown) will still hold the applique in place.



# EMBROIDERY



## STEP 9

- Return the hoop to the machine.
- Stitch Machine Step 3, Cover Stitch.

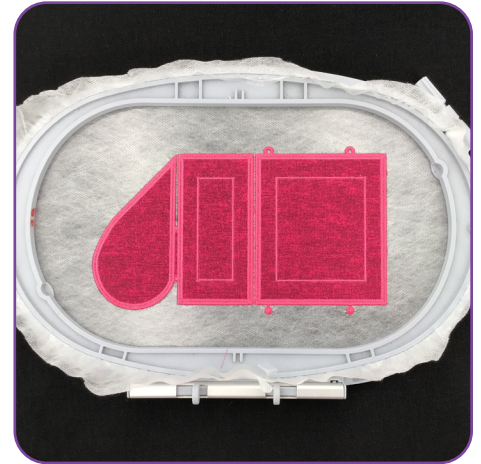

## STEP 10

- When the design is complete, remove the project from the hoop and trim the stabilizer 1/4" - 1/2" outside the design.

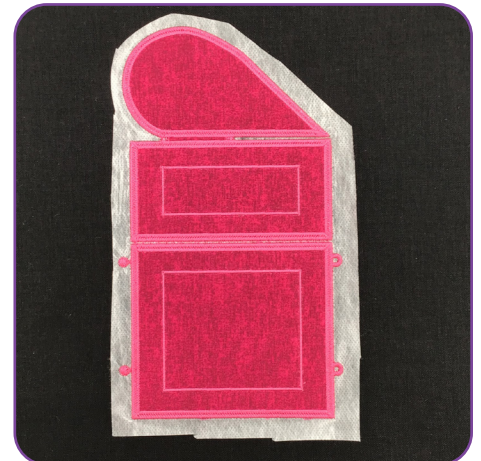



# ASSEMBLY



## STEP 11

- Rinse each piece in warm running water until the design is only slightly tacky.
- Lay right side down on a non-stick surface to dry. Parchment paper or a cooling rack work well to prevent curling. Dry completely.
- Once dry, press right side down on a Perfect Embroidery Press Cloth.



## STEP 12

- To connect, line up the pieces, right sides up.
- Thread the sewing machine with matching thread in the top and bobbin.
- Stitch together using a multi-step zigzag stitch (also known as a serpentine stitch). Back stitch at the beginning and end to secure. Trim thread tails.
- TIP: An open toe or edge stitch foot is helpful.

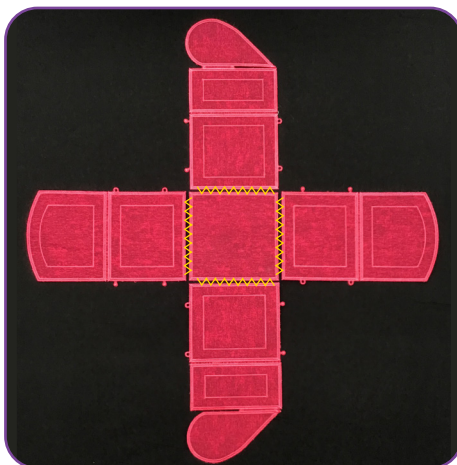

## STEP 13

- Match the eyelets to the buttonettes. Pull each buttonette through the corresponding eyelet. If needed, attach a button clip to temporarily hold the buttonette in place.

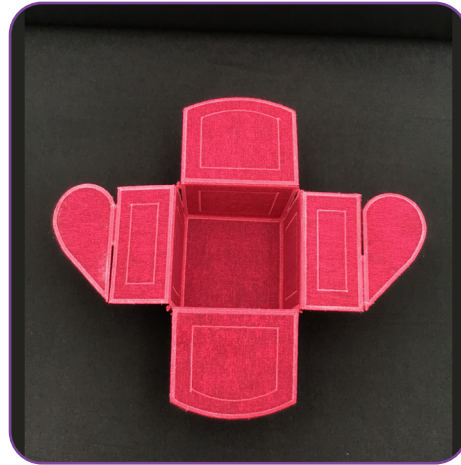
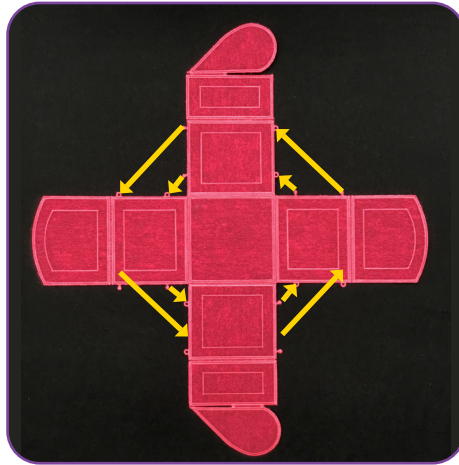

## STEP 14

- To close the lid, fold the two rounded tops inward.

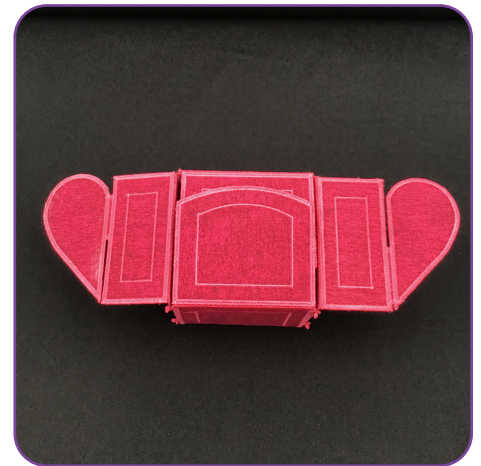

## STEP 15

- Fold the two half heart lids inward, bending slightly to slide the pair together.

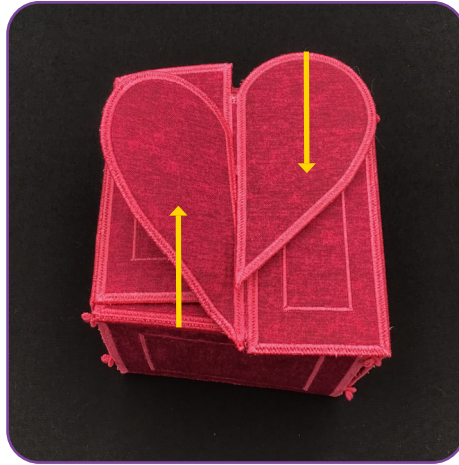

## Finishing Touches

- The Freestanding Heart Gift Boxes are complete. Enjoy!



## ATTENTION

When printing this document, any page scaling or page fitting options in your print dialog box must be turned OFF or set to NONE so that your files will print out at their actual size. Images not printed at actual size will not function as intended.

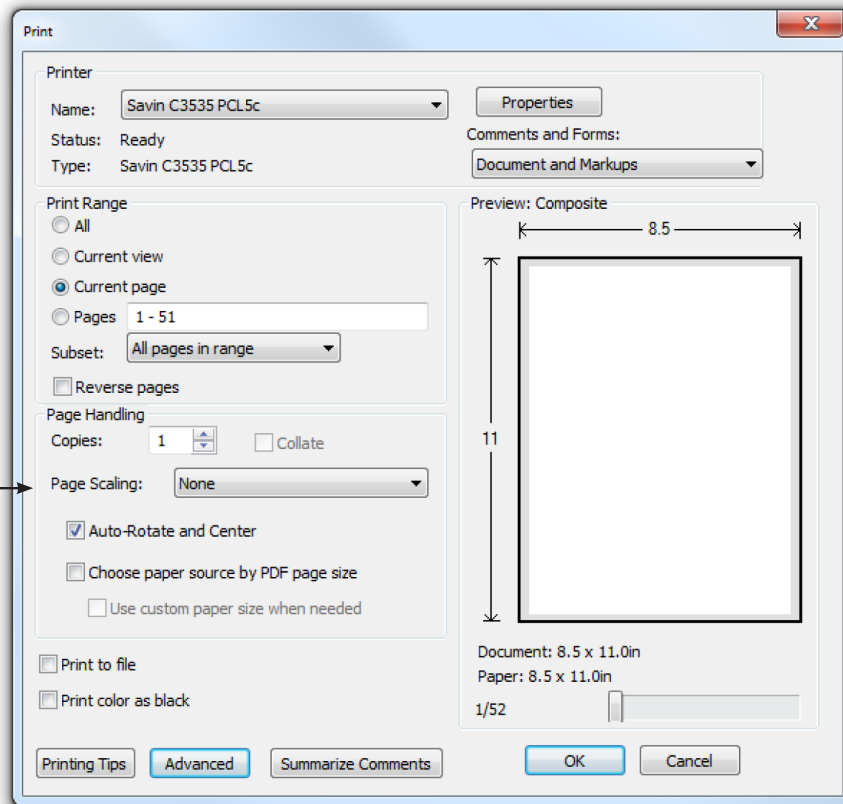

## TO SAVE PAPER

Only print the desired image by navigating to the image's page, go to File > Print and select "Current page" in the print dialog box. Repeat for each desired image.

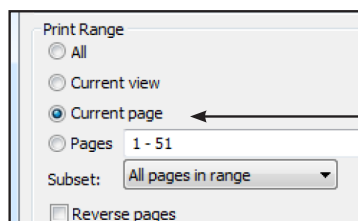

# APPLIQUE PATTERNS



Print at 100%. No scaling. This box measures 1" x 1". Use the box as an accuracy guide when printing templates.

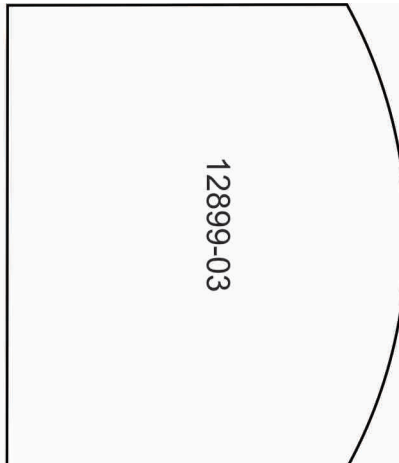
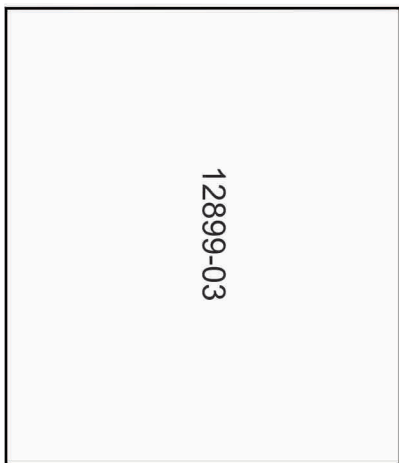
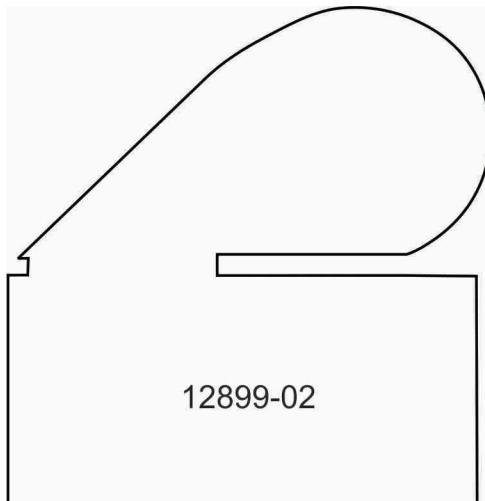
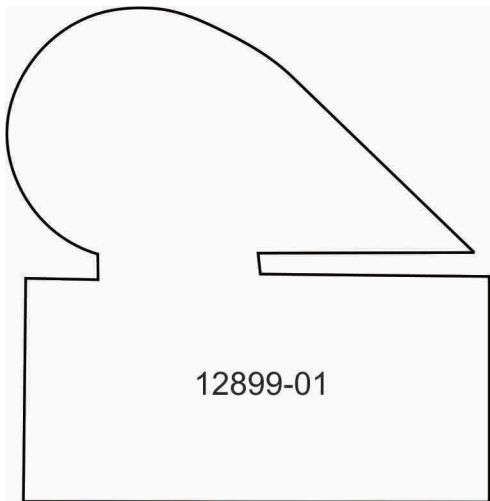

# APPLIQUE PATTERNS



Print at 100%. No scaling. This box measures 1" x 1". Use the box as an accuracy guide when printing templates.

12899-04

12899-05

12899-05

12899-06

12899-06

# APPLIQUE PATTERNS



Print at 100%. No scaling. This box measures 1" x 1". Use the box as an accuracy guide when printing templates.

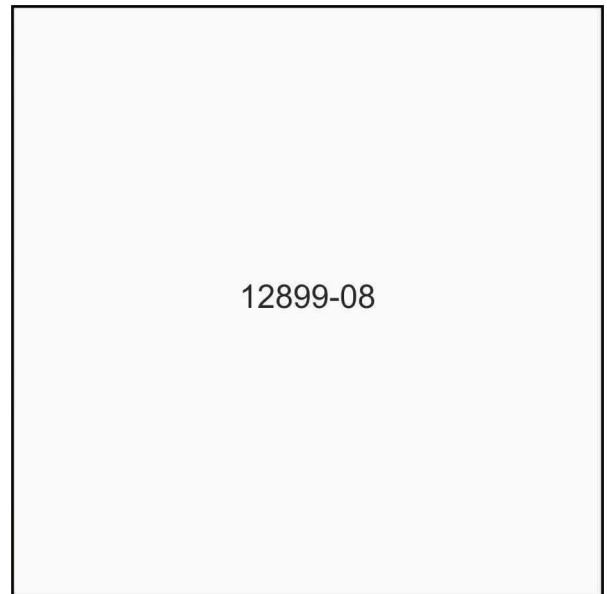
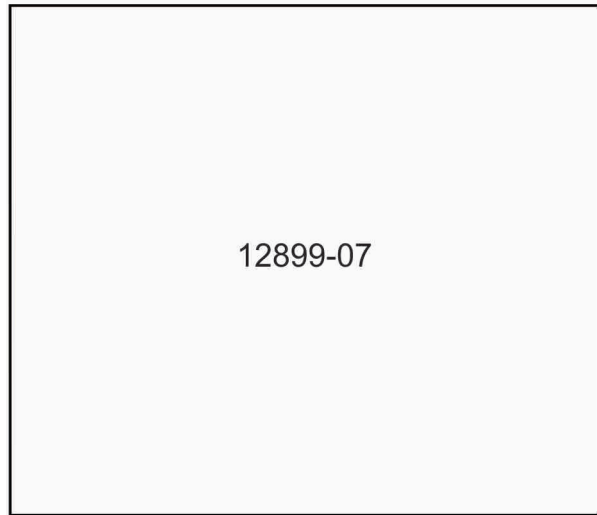
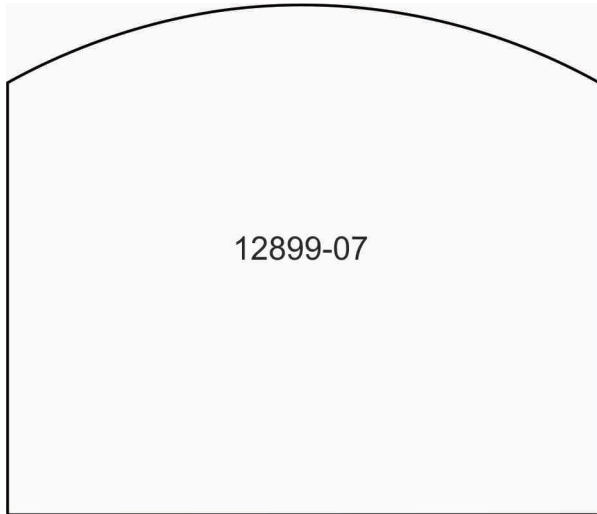



# APPLIQUE PATTERNS



Print at 100%. No scaling. This box measures 1" x 1". Use the box as an accuracy guide when printing templates.

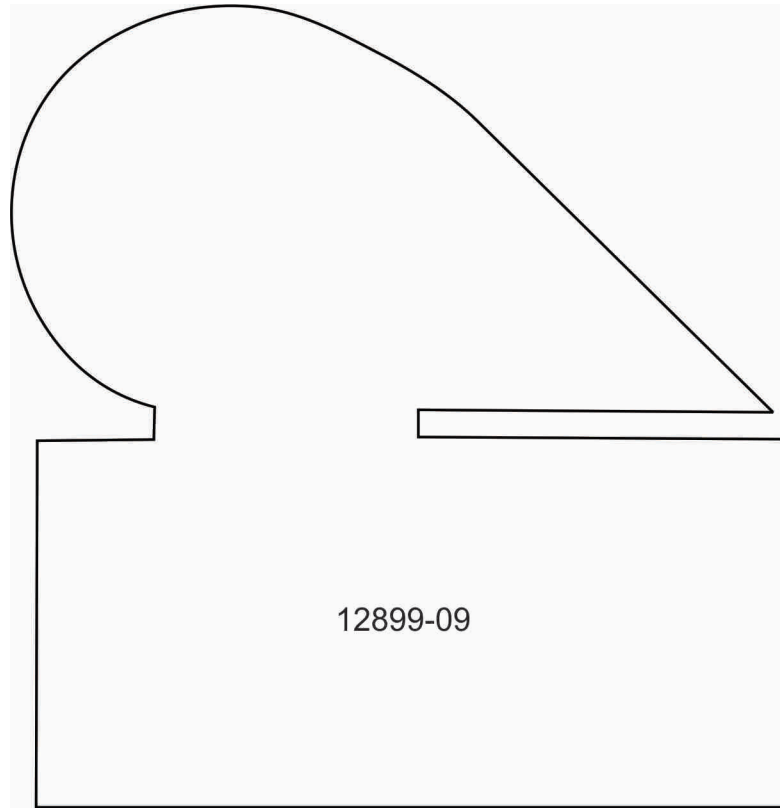

# APPLIQUE PATTERNS



Print at 100%. No scaling. This box measures 1" x 1". Use the box as an accuracy guide when printing templates.

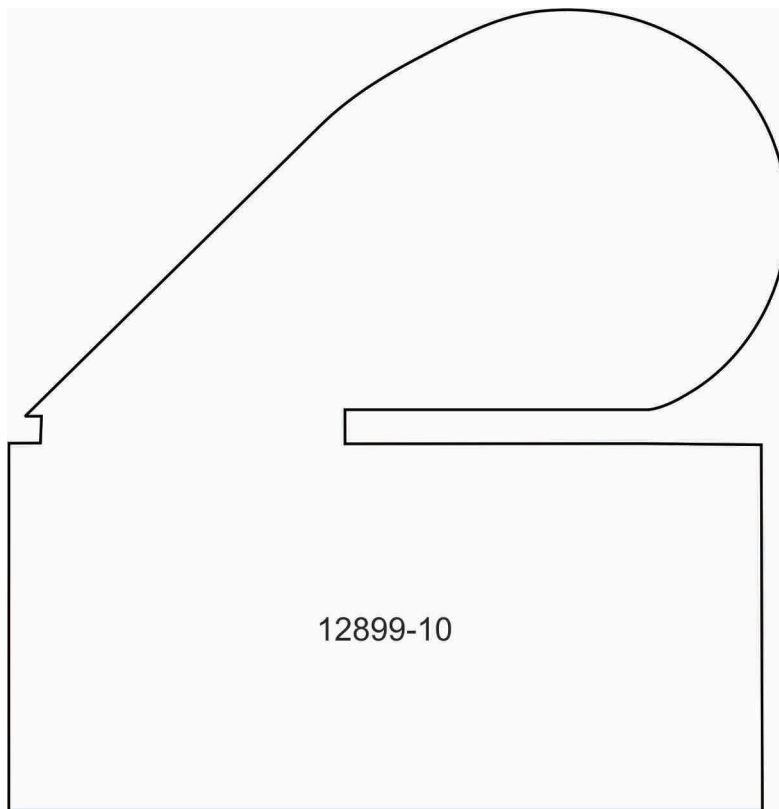

12899-10



12899-10

# APPLIQUE PATTERNS

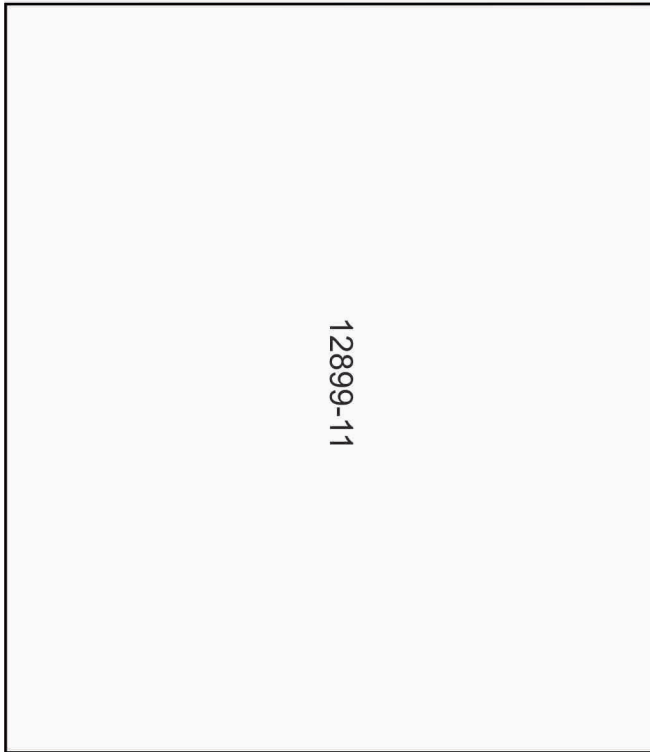

12899-11

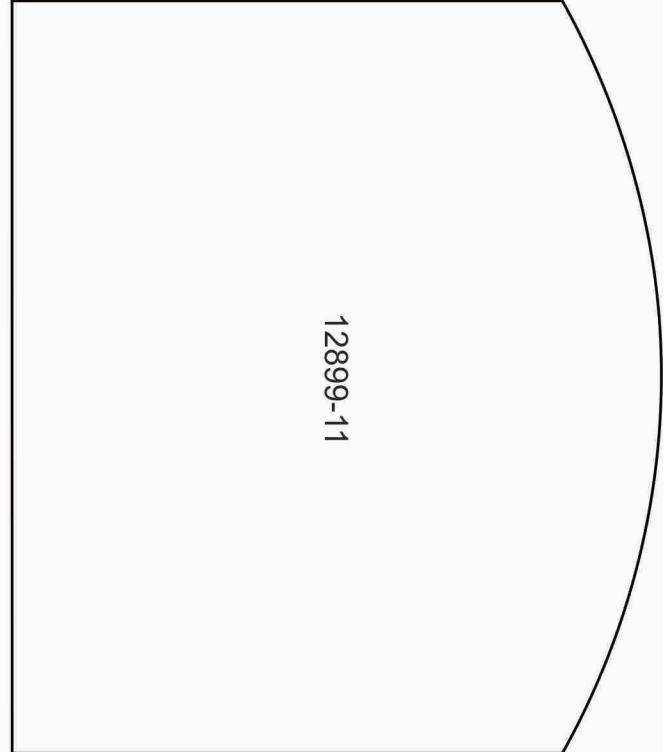

12899-11

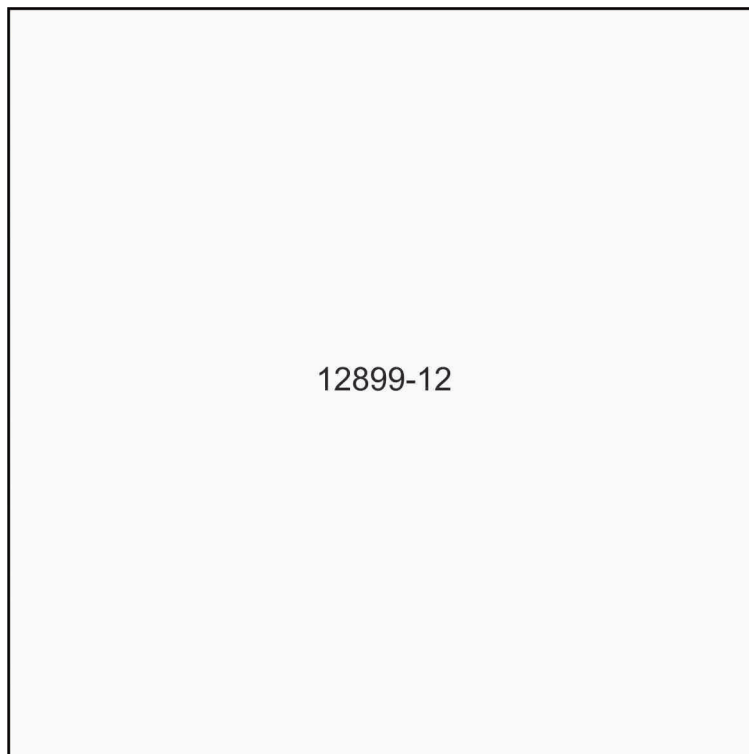

12899-12

Print at 100%. No scaling. This box measures 1" x 1". Use the box as an accuracy guide when printing templates.

# MIRRORED PATTERNS



Print at 100%. No scaling. This box measures 1" x 1". Use the box as an accuracy guide when printing templates.

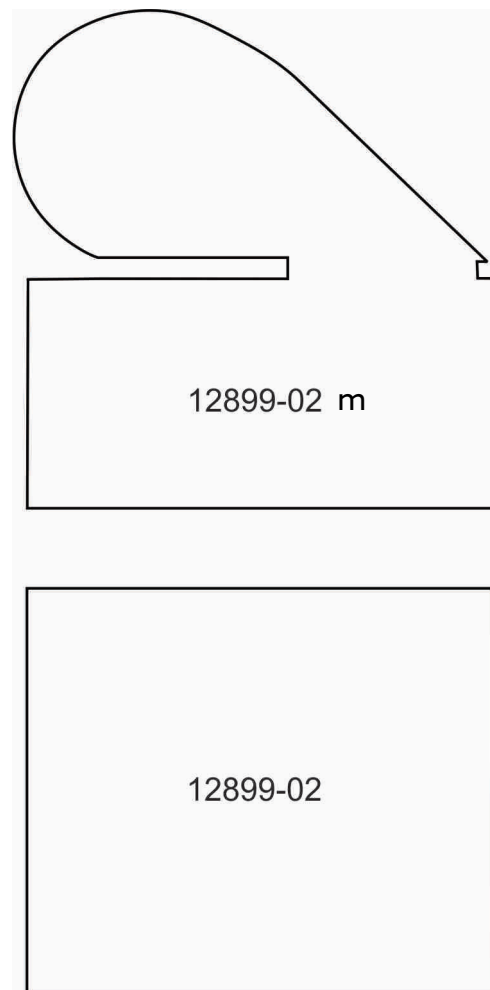
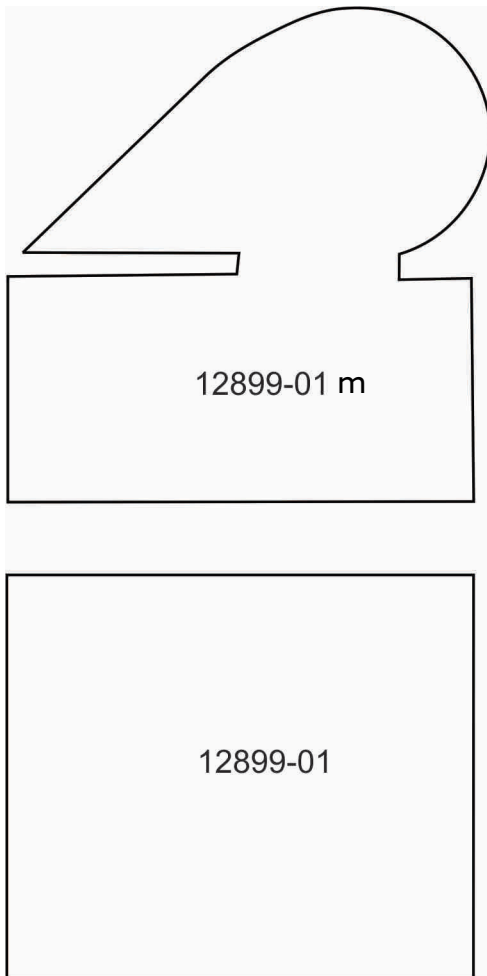

# MIRRORED PATTERNS



Print at 100%. No scaling. This box measures 1" x 1". Use the box as an accuracy guide when printing templates.

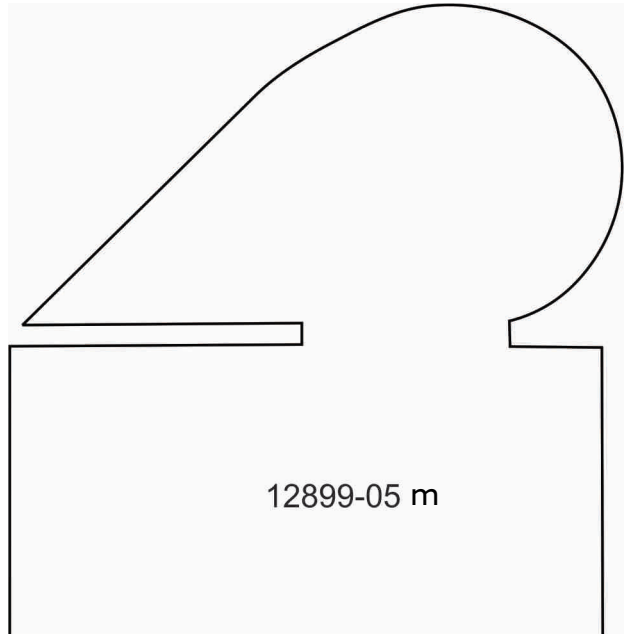
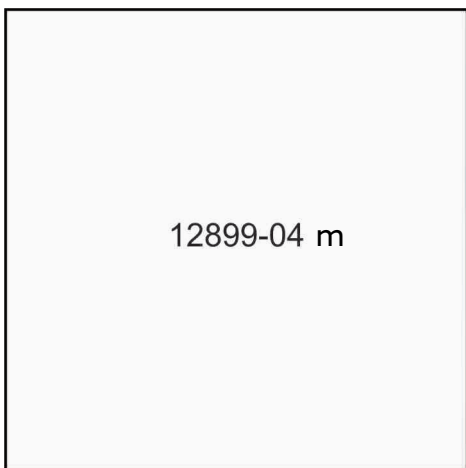
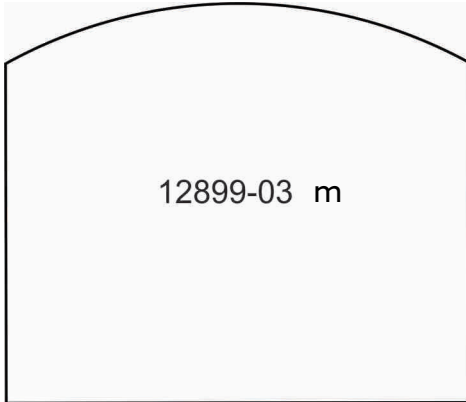

# MIRRORED PATTERNS



Print at 100%. No scaling. This box measures 1" x 1". Use the box as an accuracy guide when printing templates.

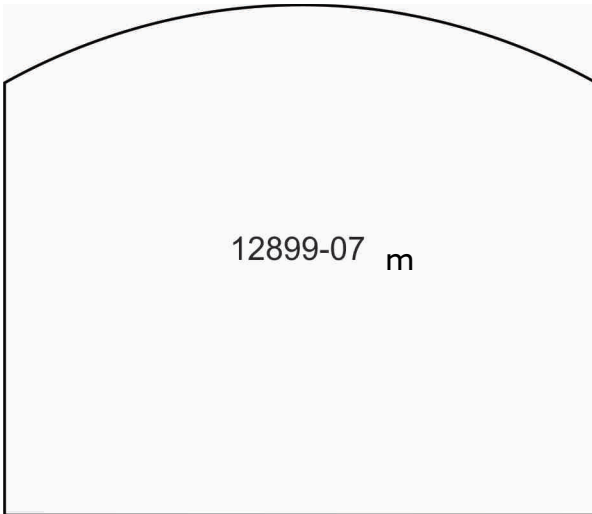

12899-07 m

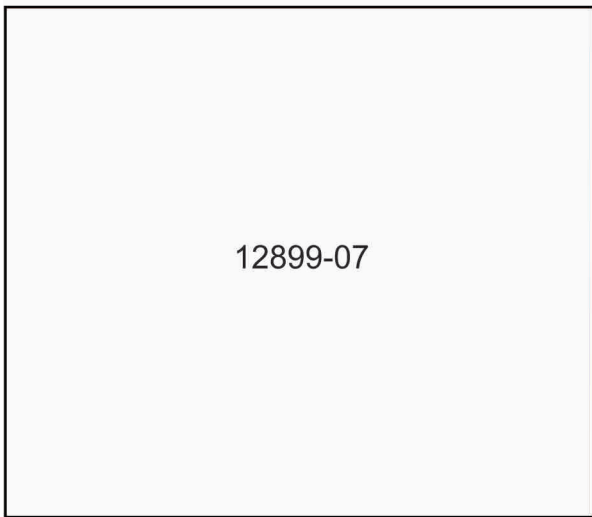

12899-07

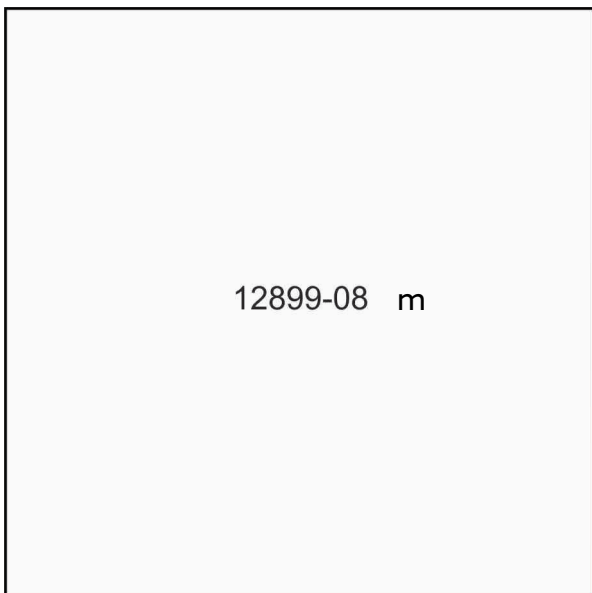

12899-08 m

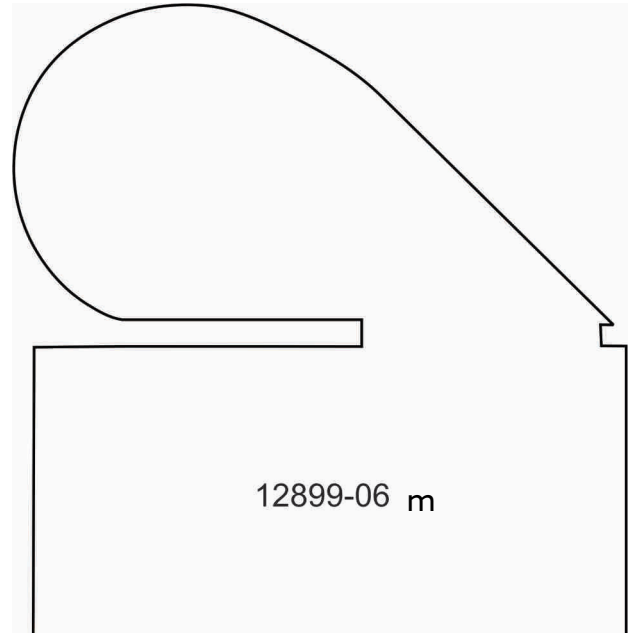

12899-06 m



12899-06

# MIRRORED PATTERNS



Print at 100%. No scaling. This box measures 1" x 1". Use the box as an accuracy guide when printing templates.

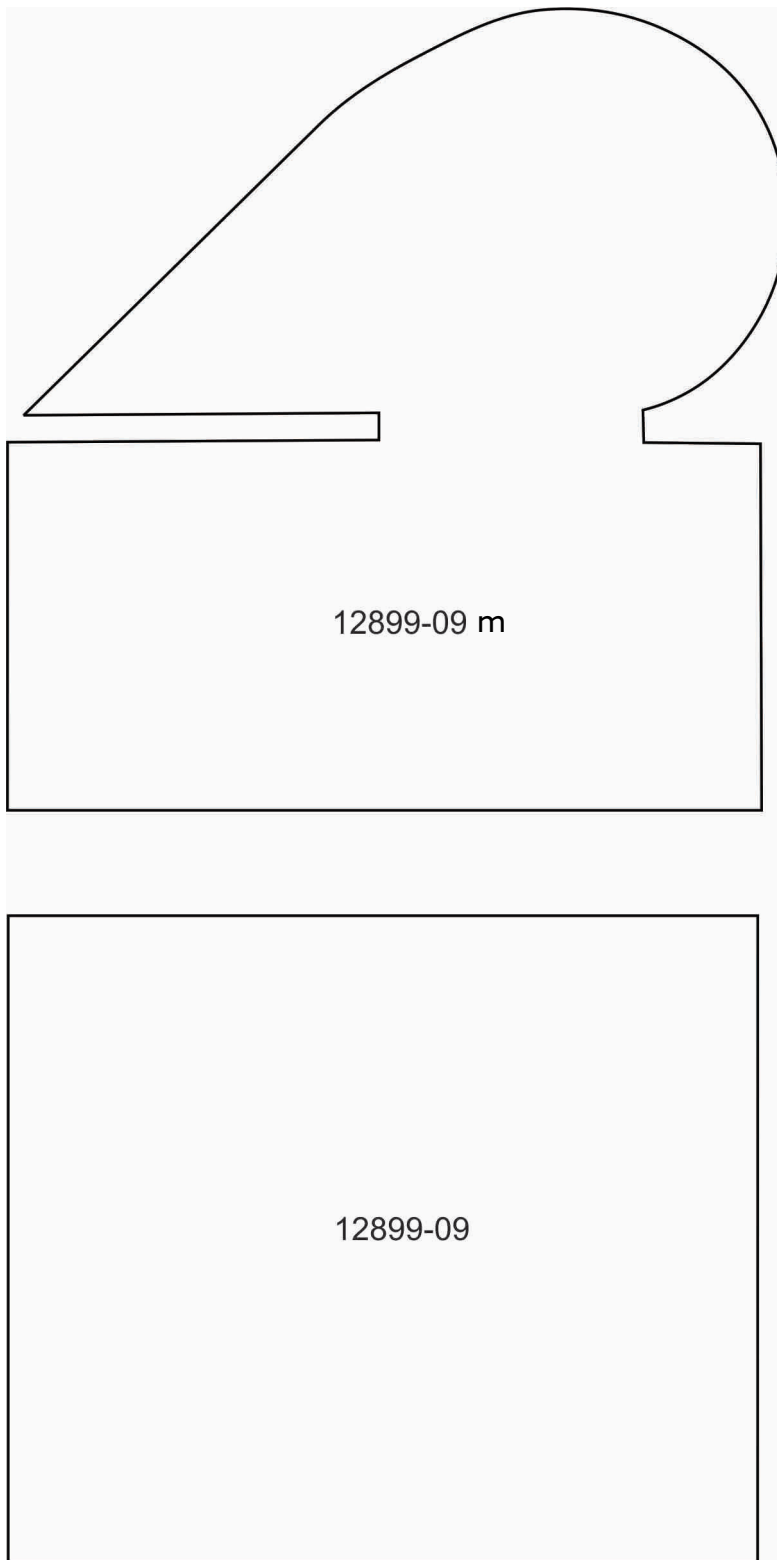

# MIRRORED PATTERNS



Print at 100%. No scaling. This box measures 1" x 1". Use the box as an accuracy guide when printing templates.

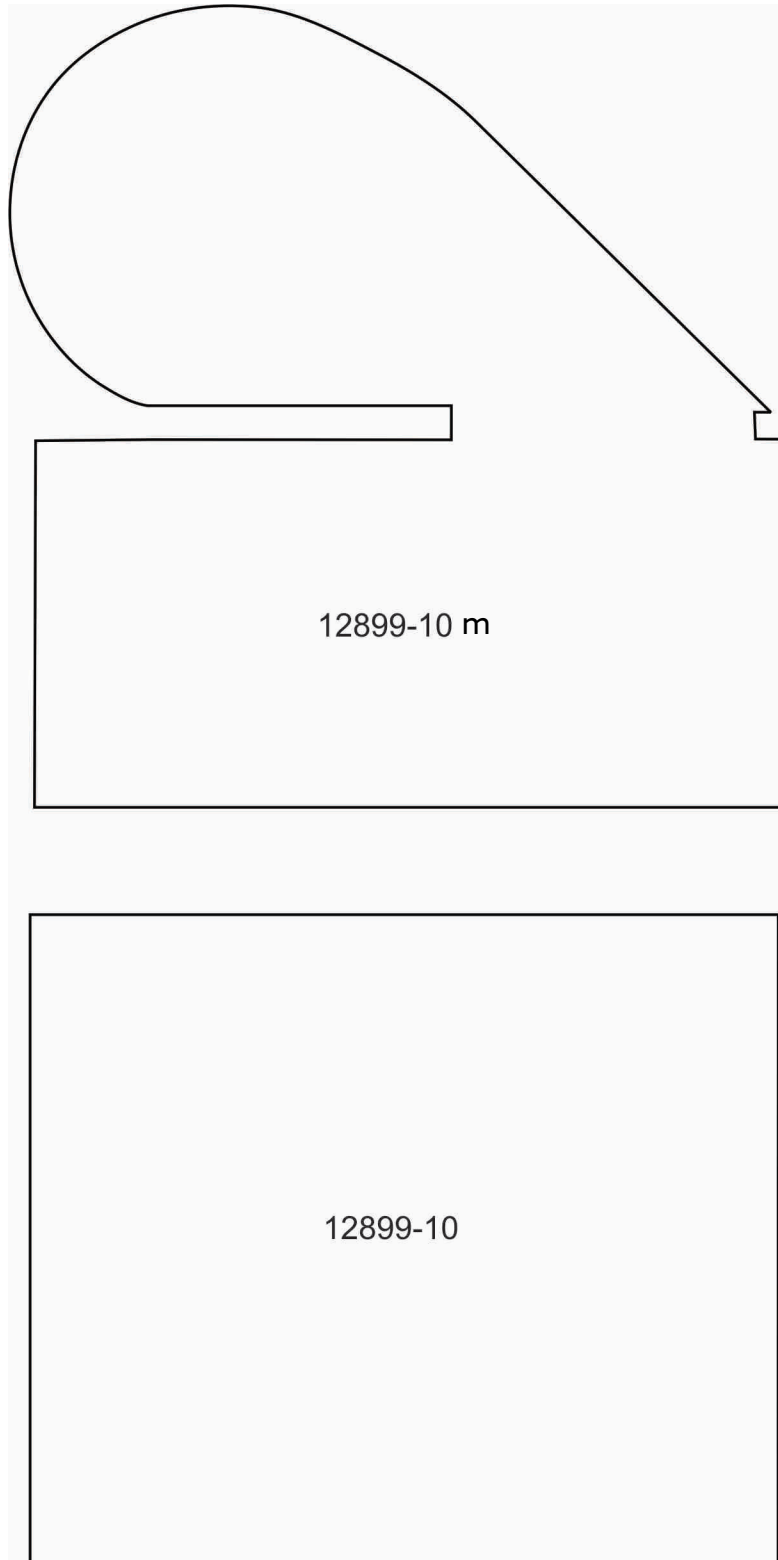



# MIRRORED PATTERNS

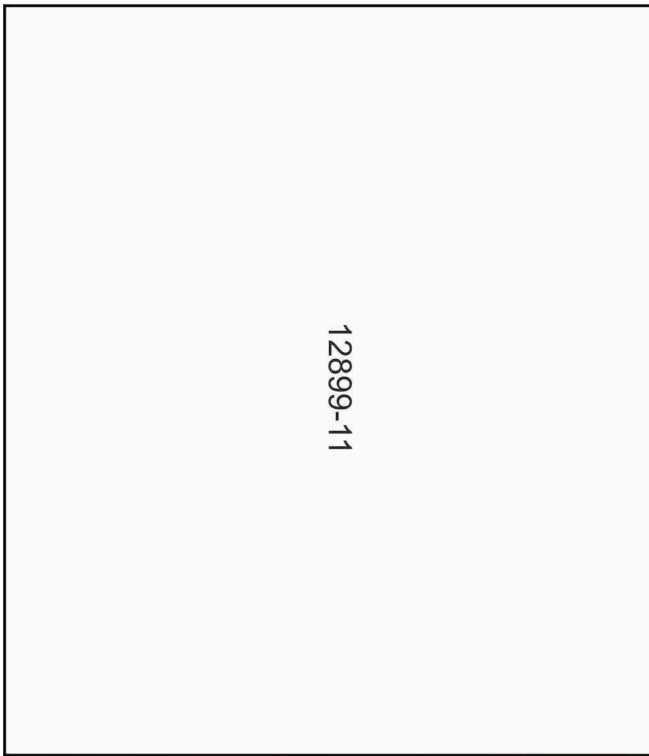

12899-11

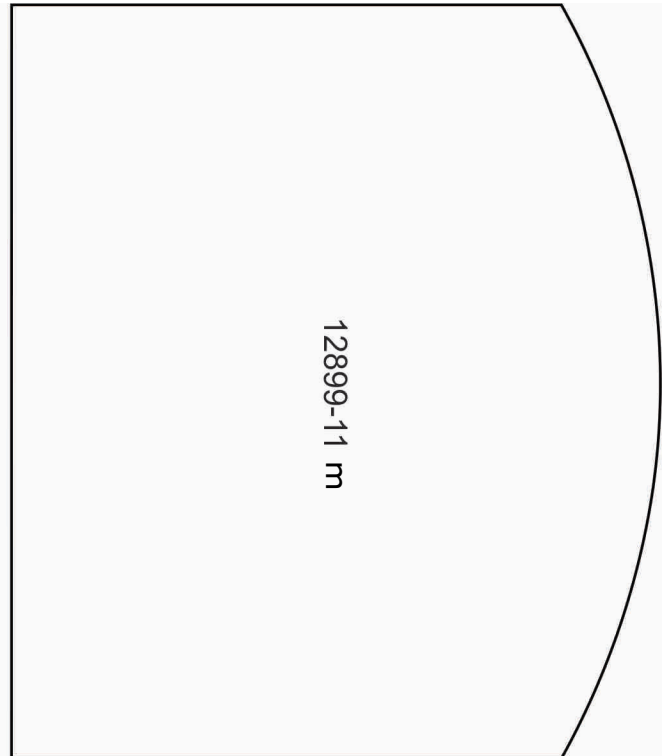

12899-11 m

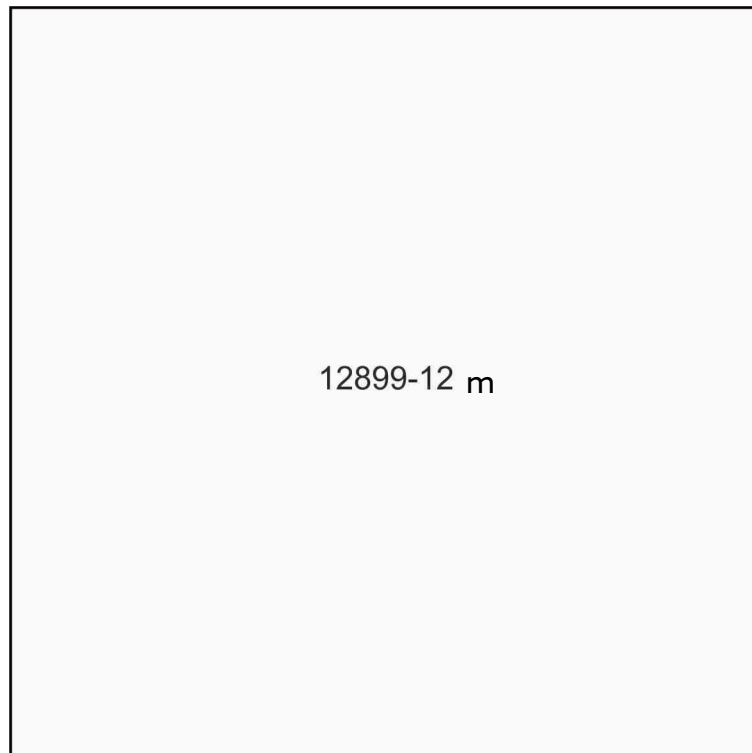

12899-12 m

Print at 100%. No scaling. This box measures 1" x 1". Use the box as an accuracy guide when printing templates.