



# FREESTANDING Gas Station



1

Design

# THREAD LIST



## Isacord Thread Colors

White Version  
0015 White

Color Version  
4073 Metal

**\* Project instructions included after design list.**

**Note: One spool of 1000 meter thread is adequate for the project unless otherwise noted.**

# TABLE OF CONTENTS

## Interactive Menu

Click to navigate to section.

Designs.....	3
Collection Supplies.....	11
Summary .....	12
Single Sided Applique Designs.....	14
Double-Sided Applique Designs.....	18
Assembly .....	23
Punch Tool Guides .....	29
Printing Instructions .....	30
Applique Patterns.....	31
Mirrored Patterns.....	37

Note: Some designs in this collection may have been created using unique special stitches and/or techniques. To preserve design integrity when rescaling or rotating designs in your software, always rescale or rotate designs using the handles directly on-screen.

**\*Fabric Required**

### 12900-01 Store Back Wall FSA



Size Inches:                      Size mm:                      Stitch Count:  
**4.98 X 3.55 in. 126.5 X 90.1 mm 38210 St.**

- 1. White Fabric Placement Stitch ..... 0015
- 2. Cut Line and Tackdown ..... 0015
- 3. Cover Stitch and White Detail ..... 0015

**\*Fabric Required**

### 12900-02 Store Wall FSA

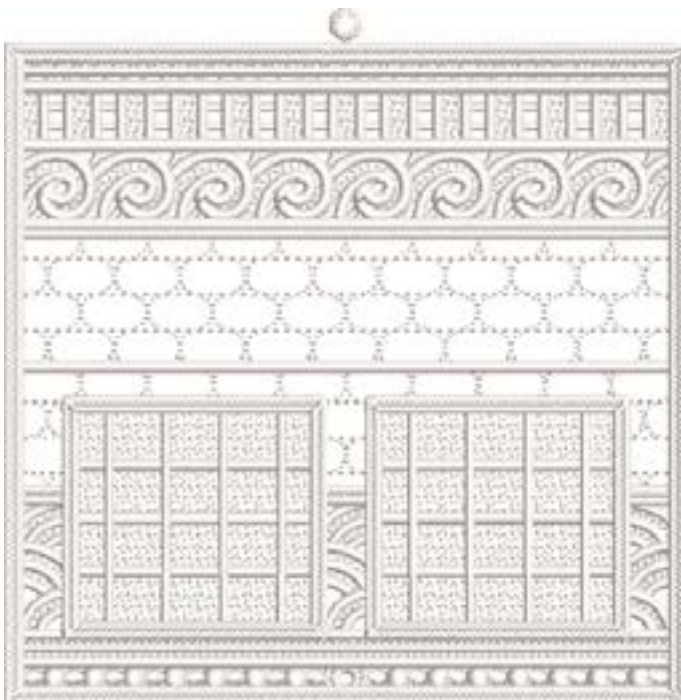

Size Inches:                      Size mm:                      Stitch Count:  
**4.98 X 4.90 in. 126.5 X 124.3 mm 50618 St.**

- 1. White Fabric Placement Stitch ..... 0015
- 2. Cut Line and Tackdown ..... 0015
- 3. Cover Stitch and White Detail ..... 0015

Note: Some designs in this collection may have been created using unique special stitches and/or techniques. To preserve design integrity when rescaling or rotating designs in your software, always rescale or rotate designs using the handles directly on-screen.

**\*Fabric Required**



### 12900-03 Store Front Wall FSA

Size Inches:                      Size mm:                      Stitch Count:  
**4.98 X 3.39 in. 126.6 X 86.0 mm 34750 St.**

- 1. White Fabric Placement Stitch ..... 0015
- 2. Cut Line and Tackdown ..... 0015
- 3. Cream Fabric Placement Stitch..... 0015
- 4. Cut Line and Tackdown ..... 0015
- 5. Cover Stitch and White Detail ..... 0015

**\*Fabric Required**

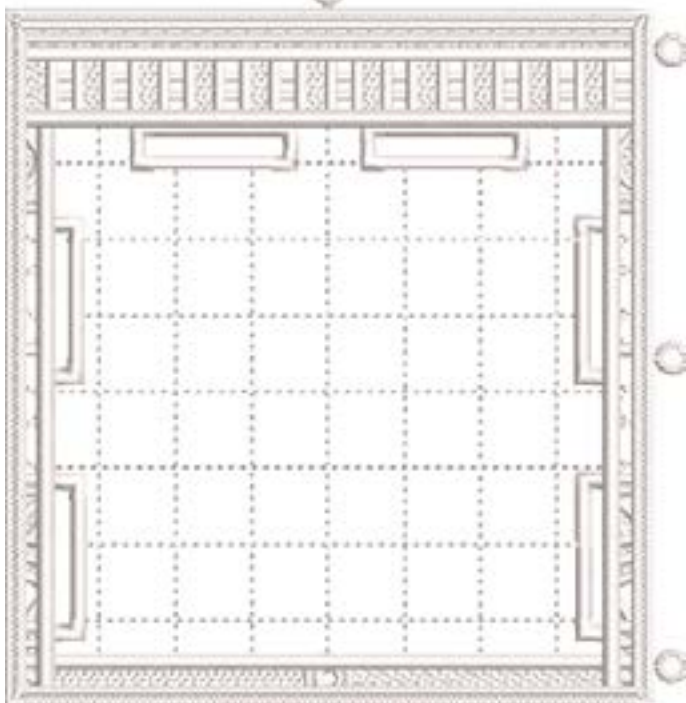

### 12900-04 Inner Wall FSA

Size Inches:                      Size mm:                      Stitch Count:  
**4.98 X 4.62 in. 126.5 X 117.4 mm 25456 St.**

- 1. White Fabric Placement Stitch ..... 0015
- 2. Cut Line and Tackdown ..... 0015
- 3. Cover Stitch and White Detail ..... 0015

Note: Some designs in this collection may have been created using unique special stitches and/or techniques. To preserve design integrity when rescaling or rotating designs in your software, always rescale or rotate designs using the handles directly on-screen.

**\*Fabric Required**

## 12900-05 Garage Roof FSA

Size Inches:                      Size mm:                      Stitch Count:  
**3.61 X 4.91 in. 91.7 X 124.6 mm 19028 St.**

- 1. Cream Fabric Placement Stitch..... 0015
- 2. Cut Line and Tackdown ..... 0015
- 3. Cover Stitch and White Detail ..... 0015

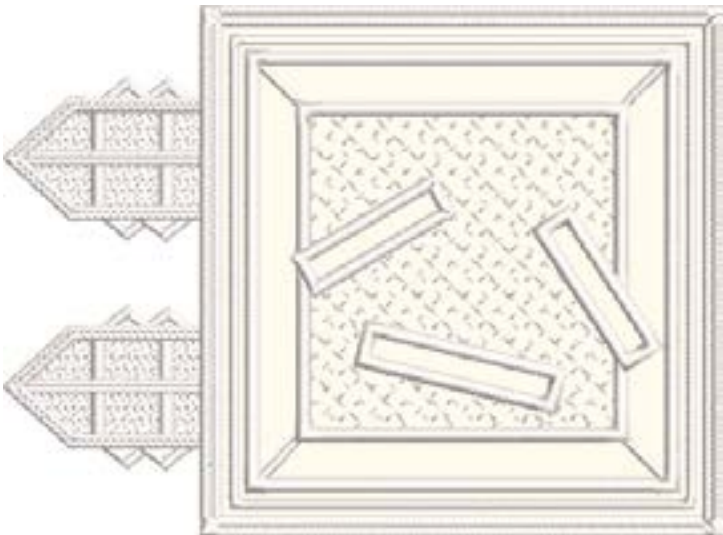

**\*Fabric Required**

## 12900-06 Garage Door FSA

Size Inches:                      Size mm:                      Stitch Count:  
**3.78 X 5.16 in. 96.0 X 131.2 mm 28717 St.**

- 1. Cream Fabric Placement Stitch..... 0015
- 2. Cut Line and Tackdown ..... 0015
- 3. Cover Stitch and White Detail ..... 0015

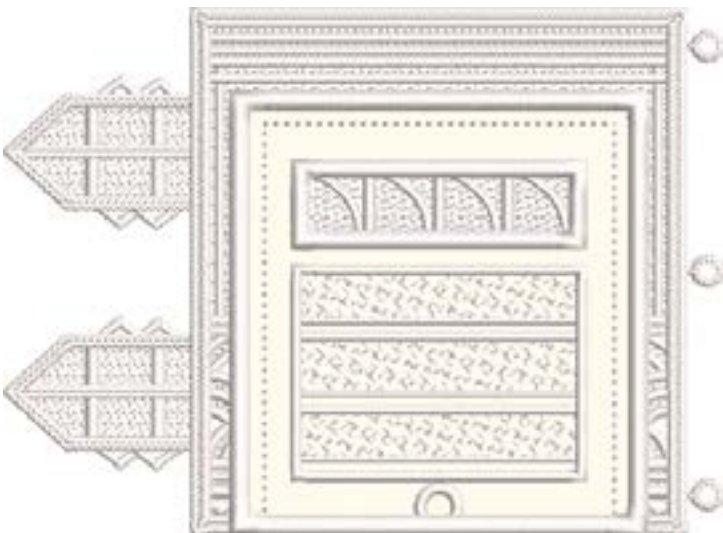

Note: Some designs in this collection may have been created using unique special stitches and/or techniques. To preserve design integrity when rescaling or rotating designs in your software, always rescale or rotate designs using the handles directly on-screen.

**\*Fabric Required**

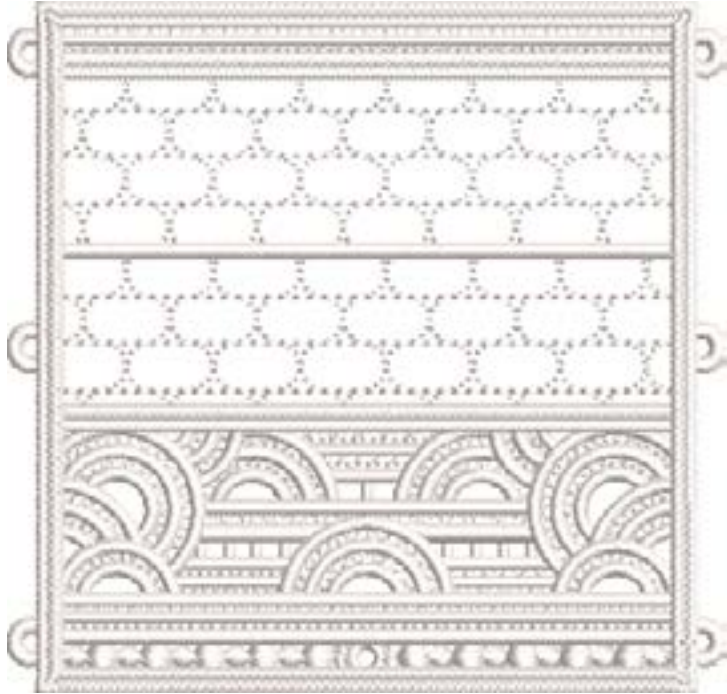

### 12900-07 Garage Wall FSA

Size Inches:                      Size mm:                      Stitch Count:  
**3.78 X 3.93 in.    96.0 X 99.8 mm    25601 St.**

- 1. White Fabric Placement Stitch ..... 0015
- 2. Cut Line and Tackdown ..... 0015
- 3. Cover Stitch and White Detail ..... 0015

**\*Fabric Required**

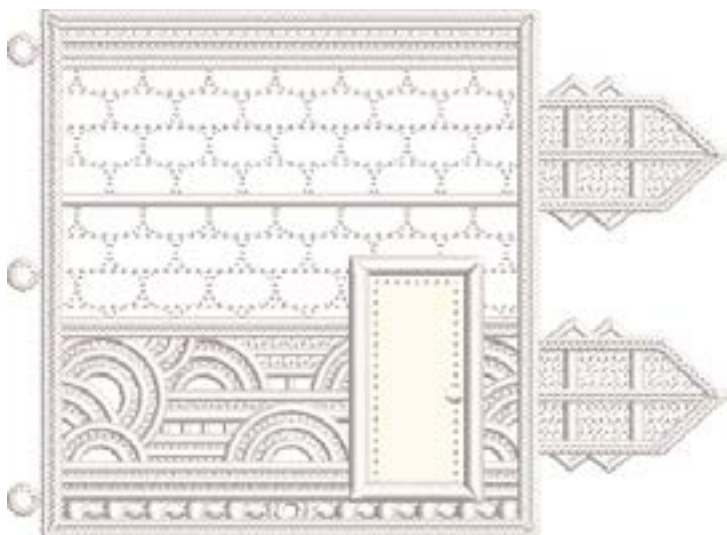

### 12900-08 Garage Back Wall FSA

Size Inches:                      Size mm:                      Stitch Count:  
**3.78 X 5.15 in.    96.0 X 130.9 mm    30617 St.**

- 1. White Fabric Placement Stitch ..... 0015
- 2. Cut Line and Tackdown ..... 0015
- 3. Cream Fabric Placement Stitch..... 0015
- 4. Cut Line and Tackdown ..... 0015
- 5. Cover Stitch and White Detail ..... 0015

Note: Some designs in this collection may have been created using unique special stitches and/or techniques. To preserve design integrity when rescaling or rotating designs in your software, always rescale or rotate designs using the handles directly on-screen.

**\*Fabric Required**

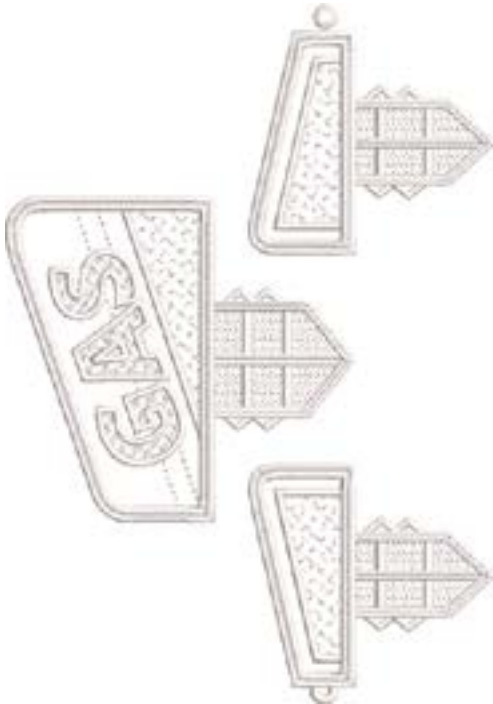

## 12900-09 Gas Sign FSA

Size Inches:                      Size mm:                      Stitch Count:  
**6.73 X 4.72 in. 170.9 X 119.8 mm 21227 St.**

- 1. White Fabric Placement Stitch ..... 0015
- 2. Cut Line and Tackdown ..... 0015
- 3. Cover Stitch and White Detail ..... 0015

**\*Fabric Required**

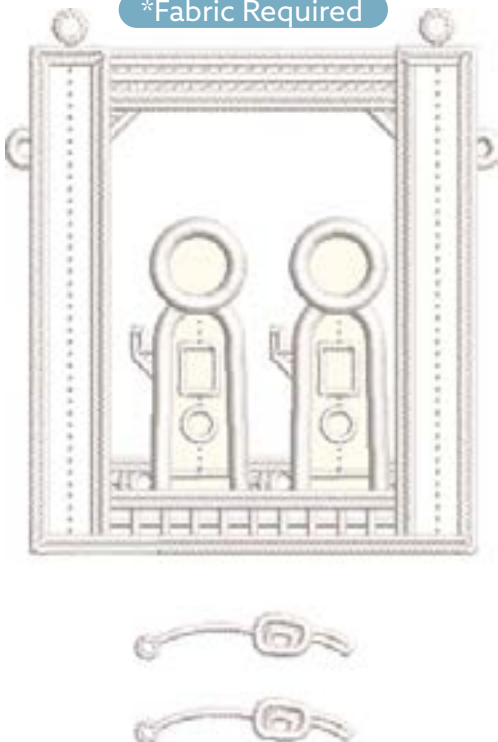

## 12900-10 Gas Pumps FSA

Size Inches:                      Size mm:                      Stitch Count:  
**4.79 X 3.24 in. 121.8 X 82.2 mm 17523 St.**

- 1. White Fabric Placement Stitch ..... 0015
- 2. Cut Line and Tackdown ..... 0015
- 3. Cream Fabric Placement Stitch..... 0015
- 4. Cut Line and Tackdown ..... 0015
- 5. Cover Stitch and White Detail ..... 0015

Note: Some designs in this collection may have been created using unique special stitches and/or techniques. To preserve design integrity when rescaling or rotating designs in your software, always rescale or rotate designs using the handles directly on-screen.

**\*Fabric Required**

## 12900-11 Overhang FSA

Size Inches:                      Size mm:                      Stitch Count:  
**4.76 X 4.97 in. 120.9 X 126.2 mm 18559 St.**

- 1. Cream Fabric Placement Stitch..... 0015
- 2. Cut Line and Tackdown ..... 0015
- 3. Cover Stitch and White Detail ..... 0015



**\*Fabric Required**

## 12900-12 Gas Pumps Foundation FSA

Size Inches:                      Size mm:                      Stitch Count:  
**5.70 X 1.75 in. 144.7 X 44.5 mm 13773 St.**

- 1. White Fabric Placement Stitch ..... 0015
- 2. Cut Line and Tackdown ..... 0015
- 3. Cover Stitch and White Detail ..... 0015





Note: Some designs in this collection may have been created using unique special stitches and/or techniques. To preserve design integrity when rescaling or rotating designs in your software, always rescale or rotate designs using the handles directly on-screen.

**\*Fabric Required**

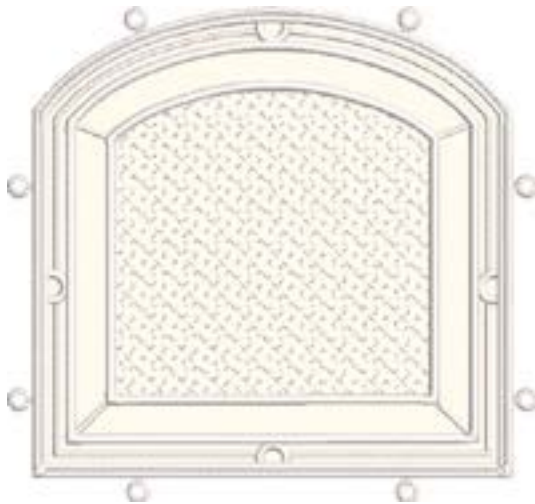

## 12900-13 Store Roof FSA

Size Inches:                      Size mm:                      Stitch Count:  
**4.90 X 5.26 in. 124.5 X 133.6 mm 16392 St.**

- 1. Cream Fabric Placement Stitch..... 0015
- 2. Cut Line and Tackdown ..... 0015
- 3. Cover Stitch and White Detail ..... 0015

**\*Fabric Required**

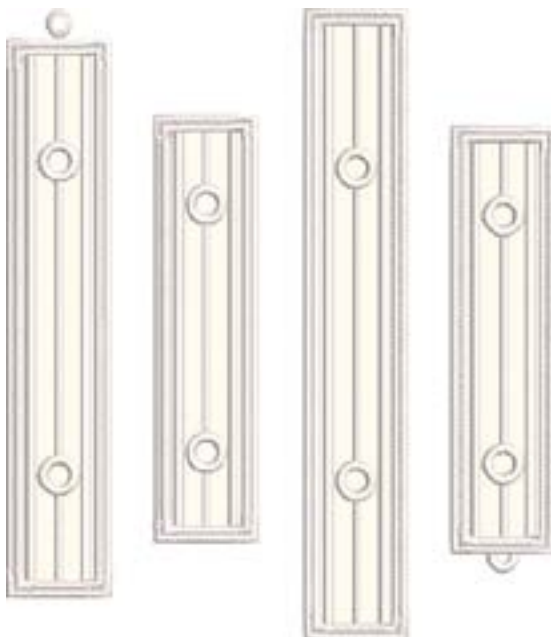

## 12900-14 Store Roof Framing FSA

Size Inches:                      Size mm:                      Stitch Count:  
**5.37 X 4.67 in. 136.3 X 118.6 mm 23566 St.**

- 1. Cream Fabric Placement Stitch..... 0015
- 2. Cut Line and Tackdown ..... 0015
- 3. Cover Stitch and White Detail ..... 0015

Note: Some designs in this collection may have been created using unique special stitches and/or techniques. To preserve design integrity when rescaling or rotating designs in your software, always rescale or rotate designs using the handles directly on-screen.

**\*Fabric Required**

### 12900-15 Store Foundation FSA

Size Inches:                      Size mm:                      Stitch Count:  
**4.88 X 4.77 in. 123.9 X 121.1 mm 13140 St.**

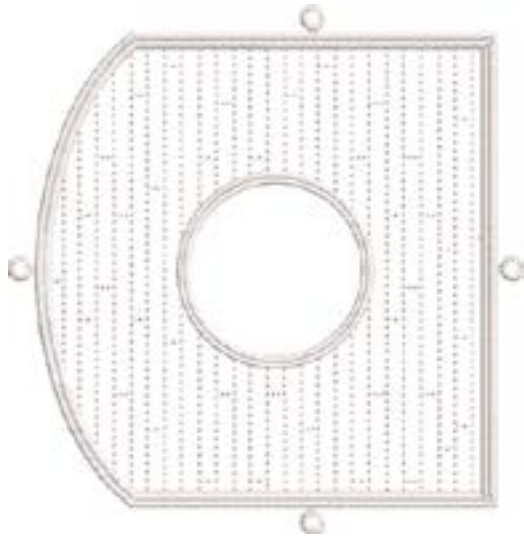

- 1. White Fabric Placement Stitch ..... 0015
- 2. Cut Line and Tackdown ..... 0015
- 3. Cover Stitch and White Detail ..... 0015

**\*Fabric Required**

### 12900-16 Garage Foundation FSA

Size Inches:                      Size mm:                      Stitch Count:  
**4.12 X 3.81 in. 104.6 X 96.7 mm 10945 St.**

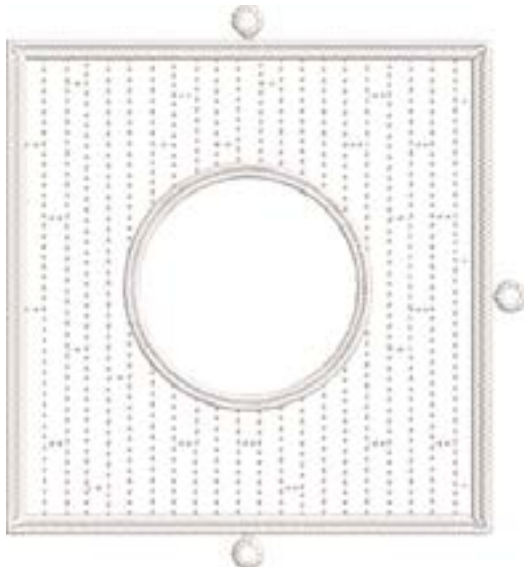

- 1. White Fabric Placement Stitch ..... 0015
- 2. Cut Line and Tackdown ..... 0015
- 3. Cover Stitch and White Detail ..... 0015

## Stabilizers

- OESD AquaMesh WashAway
- OESD BadgeMaster WashAway
- OESD StabilStick CutAway

## Fabrics/Textiles

### White version

- 1/4 yd White quilter's cotton
- 1/8 yd Cream quilter's cotton

### Color version

- 1/4 yd Gray quilter's cotton
- 1/8 yd Red quilter's cotton

- Note: Fabric sizes are estimates and may result in overage.

## Notions & Tools

- OESD Alligator Clamps
- OESD Button Clips
- OESD Expert Embroidery Tape WashAway
- OESD Expert Embroidery Tape TearAway
- OESD Perfect Punch Tool
- OESD Perfect Embroidery Press Cloth
- Embroidery Needle Sharp 75/11

## Isacord Thread Colors

- Per thread chart
- Match the bobbin thread to the upper thread.

# SUMMARY



Interactive Menu  
Click to navigate to instructions.



Completed Size:  
5" H x 8.25" W x 8.25" D

12900-01



Requires 1 Design

12900-02

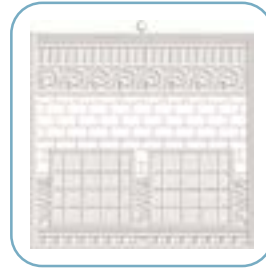

Requires 1 Design

12900-03



Requires 1 Design

12900-04

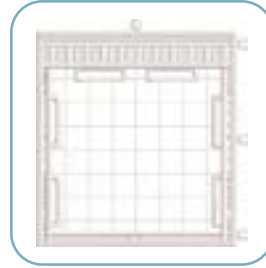

Requires 1 Design

12900-05

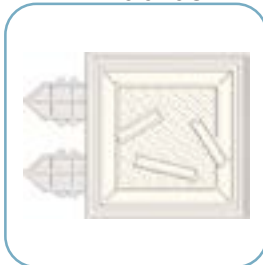

Requires 1 Design

12900-06

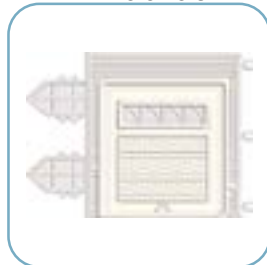

Requires 1 Design

12900-07



Requires 1 Design

12900-08

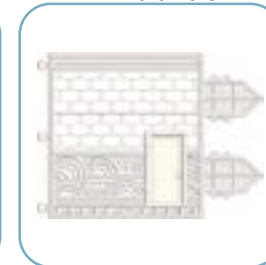

Requires 1 Design

12900-09

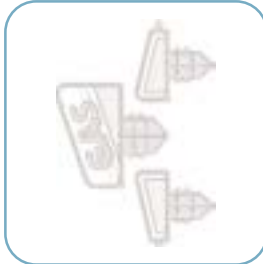

Requires 1 Design

12900-10

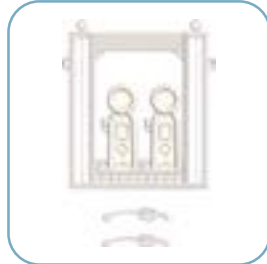

Requires 1 Design

12900-11

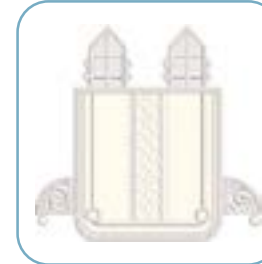

Requires 1 Design

12900-12

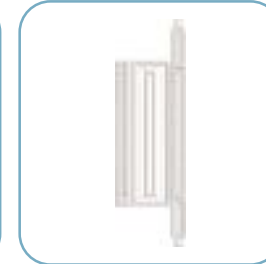

Requires 1 Design

12900-13



Requires 1 Design

12900-14

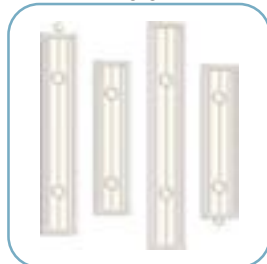

Requires 1 Design

12900-15

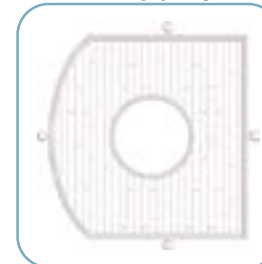

Requires 1 Design

12900-16

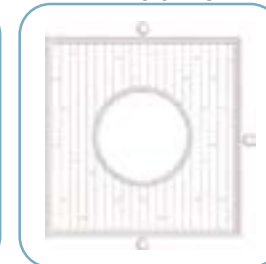

Requires 1 Design

It is a violation of Copyright law to make and distribute copies of electronic designs or artwork.  
Electronic designs are licensed to the original purchaser for use at one location. ©2022 OESD, LLC. All rights reserved.

# SUMMARY



Interactive Menu  
Click to navigate to instructions.



Completed Size:  
5" H x 8.25" W x 8.25" D

12900-01



Requires 1 Design

12900-02

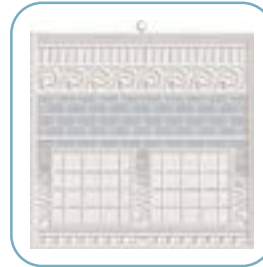

Requires 1 Design

12900-03



Requires 1 Design

12900-04

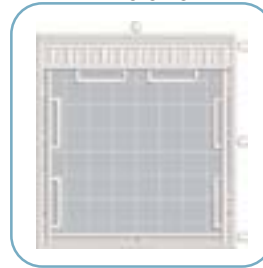

Requires 1 Design

12900-05



Requires 1 Design

12900-06



Requires 1 Design

12900-07



Requires 1 Design

12900-08

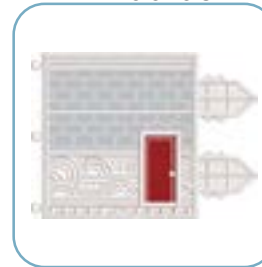

Requires 1 Design

12900-09



Requires 1 Design

12900-10

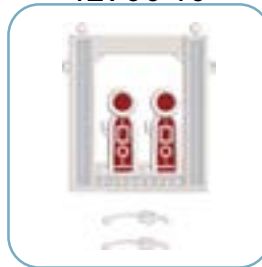

Requires 1 Design

12900-11

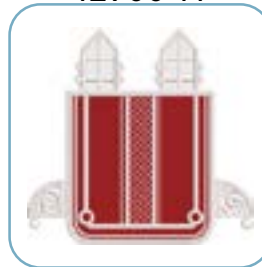

Requires 1 Design

12900-12

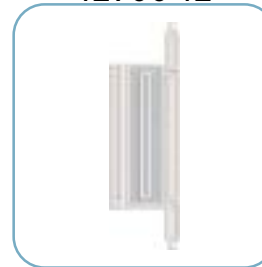

Requires 1 Design

12900-13

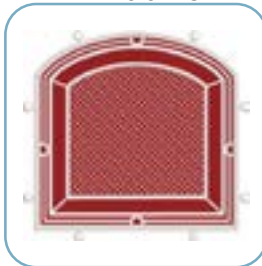

Requires 1 Design

12900-14

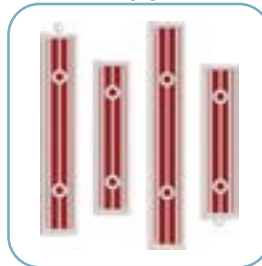

Requires 1 Design

12900-15

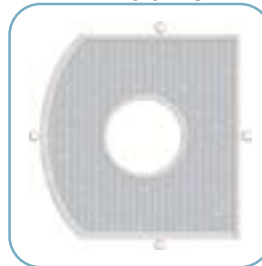

Requires 1 Design

12900-16

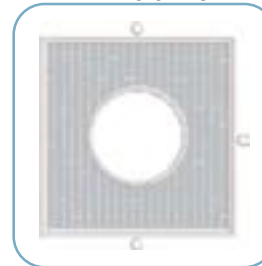

Requires 1 Design

## NOTES

The freestanding applique instructions, included in the collection, are general instructions. For demonstration purposes, a sample design that best demonstrates the technique is shown.

Fabric and thread requirements will vary by design, but the general technique is the same.

Note: Some thread colors in instructions have been changed or digitally enhanced for better visibility.

### STEP 1

- Hoop one layer of AquaMesh and one layer of BadgeMaster for all designs.



### STEP 2

- Adhere two layers of StabilStick CutAway to the wrong side of all applique fabrics, to provide stiffness to the finished structure.

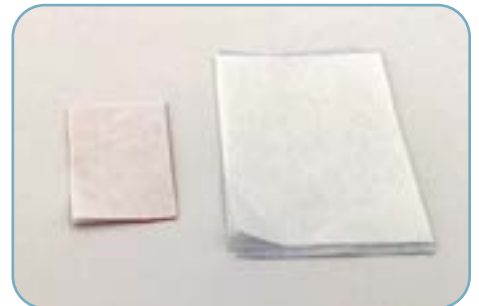

### STEP 3

- Load selected design into the machine.
- Example design is 12900-03.
- Thread the machine per the thread chart.
- Match the bobbin thread to the upper thread throughout.
- Stitch Machine Step 1, White Fabric Placement Stitch.



## STEP 4

- Remove the hoop from the machine, but NOT the project from the hoop.
- Place the hoop on a flat surface.
- Completely cover the placement stitch with the prepared fabric.
- Tape in place to secure.



## STEP 5

- Return the hoop to the machine.
- Stitch Machine Step 2, Cut Line and Tackdown.

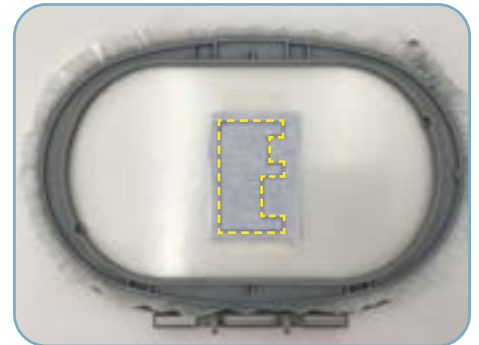

## STEP 6

- Remove the hoop from the machine, but NOT the project from the hoop.
- Trim the excess fabric as close to the cut line as possible. If the outermost stitches (cut line) are cut, the inner stitches (tackdown) will hold the applique in place.
- Tip: If the AquaMesh is cut or a hole is created while trimming the fabric, use OESD Expert Embroidery Tape WashAway as a patch.



## STEP 7

- Return the hoop to the machine.
- Stitch Machine Step 3, Cream Fabric Placement Stitch.

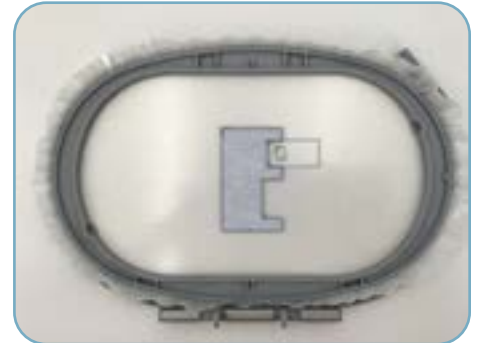

## STEP 8

- Remove the hoop from the machine, but NOT the project from the hoop.
- Place the hoop on a flat surface.
- Completely cover the placement stitch with the prepared fabric.
- Tape in place to secure.

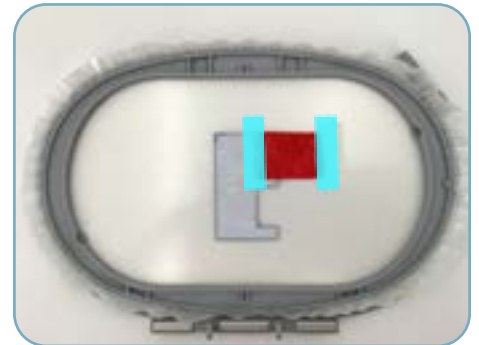

## STEP 9

- Return the hoop to the machine.
- Stitch Machine Step 4, Cut Line and Tackdown.

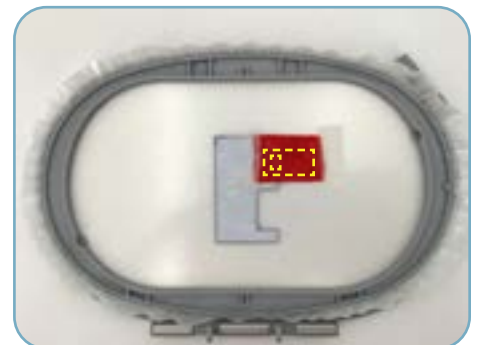



## STEP 10

- Remove the hoop from the machine, but NOT the project from the hoop.
- Trim the excess fabric as close to the cut line as possible.

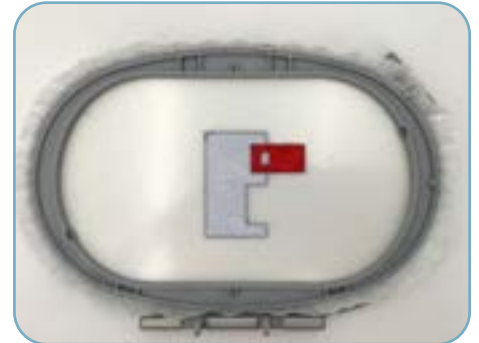

## STEP 11

- Return the hoop to the machine and stitch the remaining machine steps, per the thread chart.



## STEP 12

- When the design is complete, remove the project from the hoop and trim the stabilizer 1/4" - 1/2" outside the design.



# EMBROIDERY DOUBLE-SIDED APPLIQUE



- Designs 12900-10, 12900-11 and 12900-14

## STEP 13

- Hoop one layer of AquaMesh and one layer of BadgeMaster for all designs.



## STEP 14

- Adhere one layer of StabilStick CutAway to the wrong side of all applique fabrics, to provide stiffness to the finished structure.
- Note: Double-sided applique only needs one layer of StabilStick CutAway to provide stiffness to the structure.

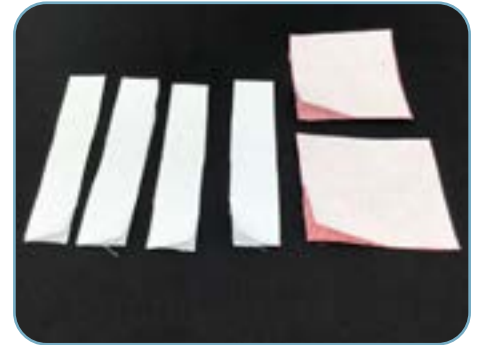

## STEP 15

- Load selected design into the machine.
- Example design is 12900-10.
- Thread the machine per the thread chart.
- Match the bobbin thread to the upper thread throughout.
- Stitch Machine Step 1, White Fabric Placement Stitch.



## STEP 16

- Remove the hoop from the machine, but NOT the project from the hoop.
- Place the hoop on a flat surface.
- Completely cover the placement stitch with the prepared fabric.
- Tape in place to secure.



## STEP 17

- Turn the hoop over and place the fabric, right side up, completely covering the placement stitch.
- Carefully tape to secure.
- Tip: Avoid pushing too hard on the stabilizer to prevent it from dislodging from the hoop.



## STEP 18

- Return the hoop to the machine.
- Stitch Machine Step 2, Cut Line and Tackdown.



# EMBROIDERY DOUBLE-SIDED APPLIQUE



## STEP 19

- Remove the hoop from the machine, but NOT the project from the hoop.
- Trim the excess fabric as close to the cut line as possible.



## STEP 20

- Turn the hoop over and trim the excess fabric as close to the cut line as possible.



## STEP 21

- Return the hoop to the machine.
- Stitch Machine Step 3, Cream Fabric Placement Stitch.



## STEP 22

- Remove the hoop from the machine, but NOT the project from the hoop.
- Place the hoop on a flat surface.
- Completely cover the placement stitch with the prepared fabric.
- Tape in place to secure.



## STEP 23

- Turn the hoop over and place the fabric, right side up, completely covering the placement stitch.
- Carefully tape to secure. Avoid pushing too hard on the stabilizer to prevent it from dislodging from the hoop.



## STEP 24

- Return the hoop to the machine.
- Stitch Machine Step 4, Cut Line and Tackdown.



## STEP 25

- Remove the hoop from the machine, but NOT the project from the hoop.
- Trim the excess fabric as close to the cut line as possible.



## STEP 26

- Turn the hoop over and trim the excess fabric as close to the cut line as possible.



## STEP 27

- Return the hoop to the machine and stitch the remaining machine steps, per the thread chart.

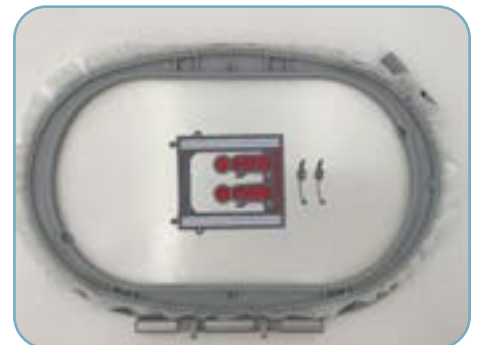

## STEP 28

- When the design is complete, remove the project from the hoop and trim the stabilizer 1/4" - 1/2" outside the design.



# ASSEMBLY



## STEP 29

- Rinse each piece in warm running water until the design is only slightly tacky.
- Lay right side down on a non-stick surface to dry. Parchment paper or a cooling rack work well to prevent curling. Dry completely.
- Once dry, press right side down on a Perfect Embroidery Press Cloth.



## STEP 30

- Before assembly, use a utility knife to cut through all the layers of the tab entries. Take care to not cut the satin stitching.
- Using the OESD Perfect Punch Tool fitted with the 3mm tip, punch out the designated eyelets. Punch tool guides are located on page 29 of the instructions.

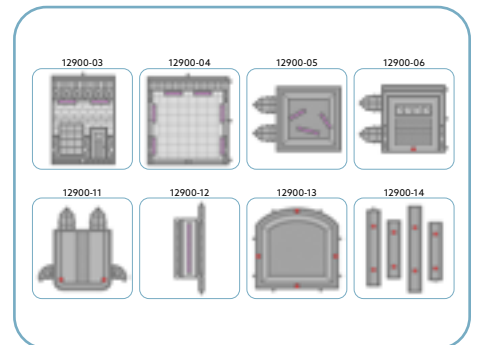

## STEP 31

- To connect, line up pieces Store Back Wall FSA (12900-01), Store Wall FSA (12900-02), Store Front Wall FSA (12900-03), and Inner Wall FSA (12900-04), right sides up.
- Thread the sewing machine with matching thread in the top and bobbin.
- Stitch together using a multi-step zigzag stitch (also known as a serpentine stitch). Back stitch at the beginning and end to secure. Trim thread tails.
- TIP: An open toe or edge stitch foot is helpful.

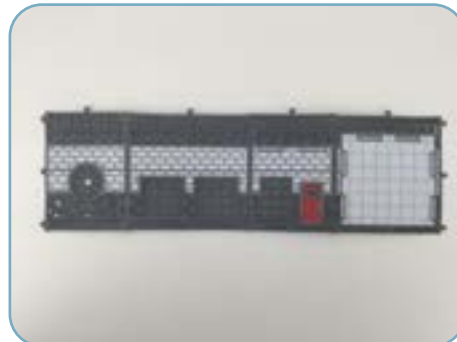
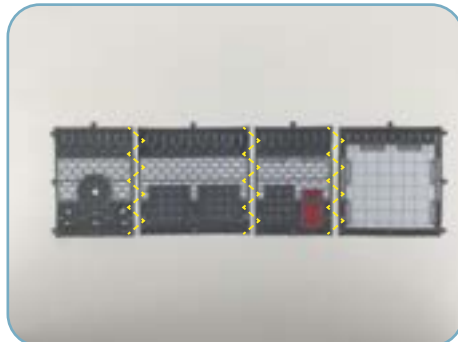

## STEP 32

- To connect, line up pieces Garage Roof FSA (12900-05), Garage Door FSA (12900-06), Garage Wall FSA (12900-07), Garage Back Wall FSA (12900-08), right sides up.
- Stitch together.
- Match eyelets to the corresponding buttonettes to create the structure.

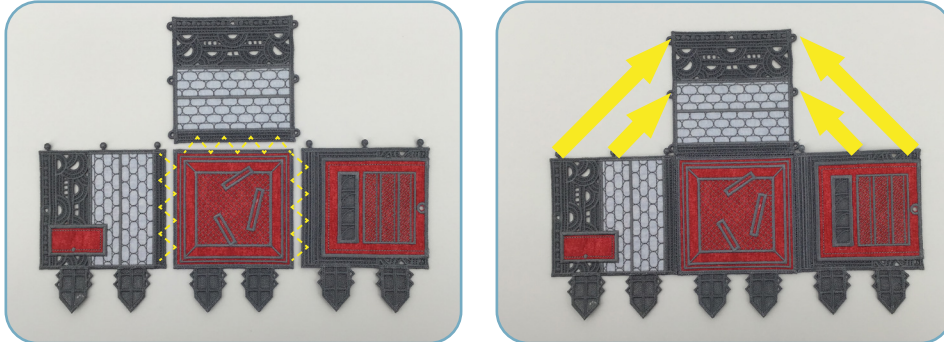

## STEP 33

- To connect, line up Store Roof Framing FSA (12900-14), right sides up.
- Thread the sewing machine with matching thread in the top and bobbin.
- Stitch together using a multi-step zigzag stitch (also known as a serpentine stitch). Back stitch at the beginning and end to secure. Trim thread tails.

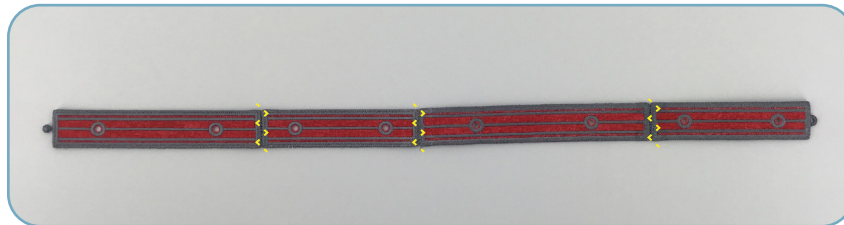

## STEP 34

- Match the eyelets on Store Back Wall FSA (12900-01) to the buttonettes on Inner Wall FSA (12900-04). Pull each buttonette through the corresponding eyelet. Attach a button clip to hold the buttonette in place temporarily when needed.

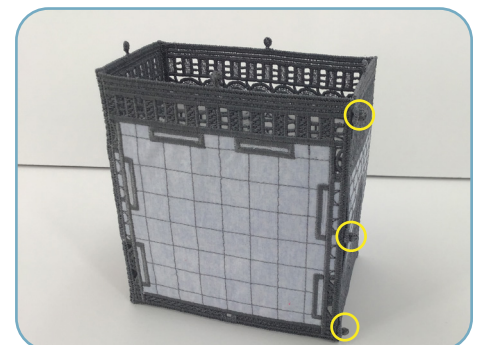



## STEP 35

- Stitch together using a multi-step zigzag stitch.
- Match the eyelet on Gas Sign FSA (12900-09) to the buttonette. Pull buttonette through the corresponding eyelet.



## STEP 36

- Insert the tabs on Gas Sign FSA (12900-09) into the corresponding garage slots.



## STEP 37

- Insert the tabs on assembled garage into the corresponding store slots.

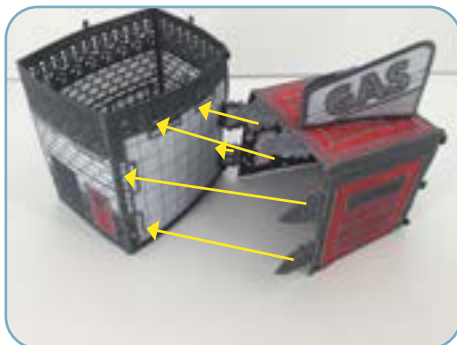

## STEP 38

- Match the eyelets on Gas Pumps FSA (12900-12) to the buttonettes. Pull each buttonette through the corresponding eyelet.

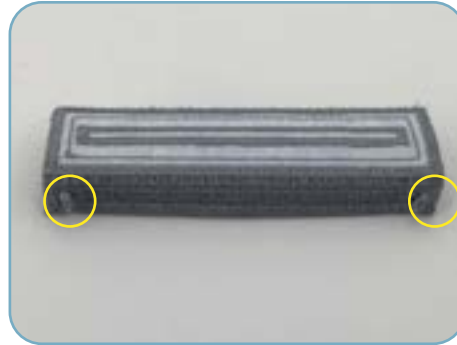

## STEP 39

- Match the eyelets and buttonettes on Gas Pumps FSA (12900-10) to the eyelets and buttonettes on Overhang FSA (12900-11). Pull each buttonette through the corresponding eyelet.

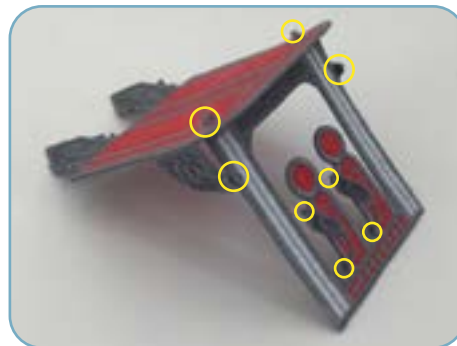
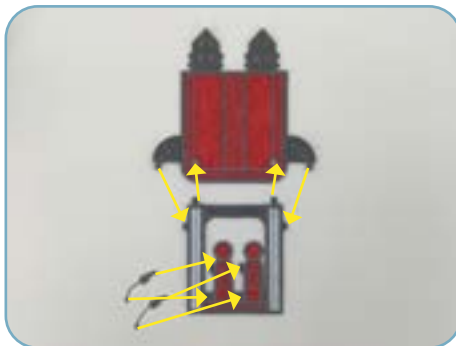

## STEP 40

- Insert the assembled gas pumps into the corresponding slot on Gas Pumps Foundation FSA (12900-12).

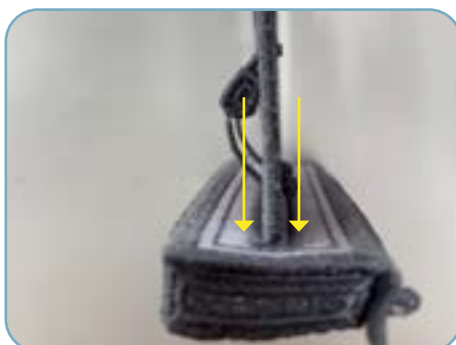

# ASSEMBLY



## STEP 41

- Insert the tabs on gas pump assembly into the corresponding store slots.



## STEP 42

- Match the eyelets on garage assembly to the buttonettes on Garage Foundation FSA (12900-16). Pull each buttonette through the corresponding eyelet.

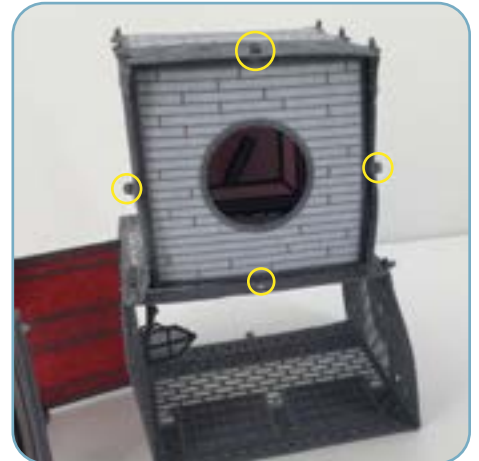

## STEP 43

- Match the eyelets on store assembly to the buttonettes on Store Foundation FSA (12900-15). Pull each buttonette through the corresponding eyelet.

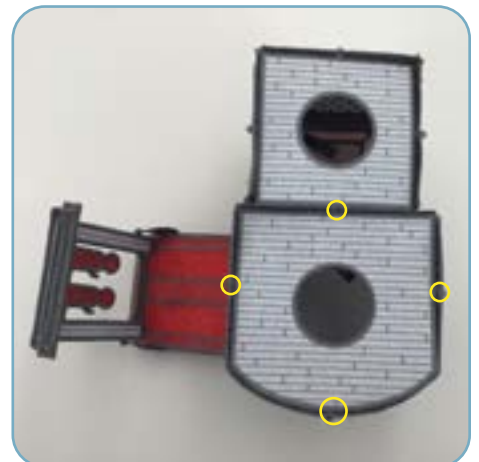

# ASSEMBLY



## STEP 44

- Match the eyelets on Store Roof FSA (12900-13) to the buttonettes on store assembly. Pull each buttonette through the corresponding eyelet.

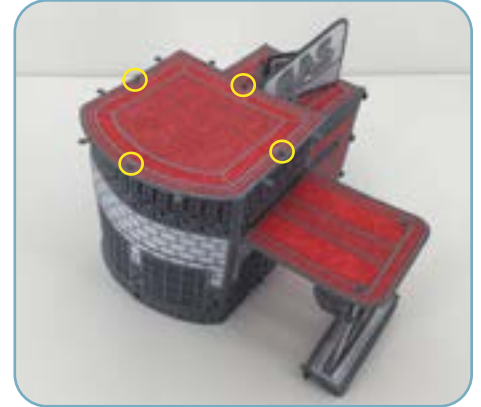

## STEP 45

- Match the eyelet to the buttonette of Store Roof Framing FSA (12900-14). Pull the buttonette through the corresponding eyelet.



## STEP 46

- Match the eyelets on Store Roof Framing FSA (12900-14) to the buttonettes on store assembly. Pull each buttonette through the corresponding eyelet.



## STEP 47

- Add tea lights or pixie lights to create a glow.



# PUNCH TOOL GUIDES



12900-03



12900-04

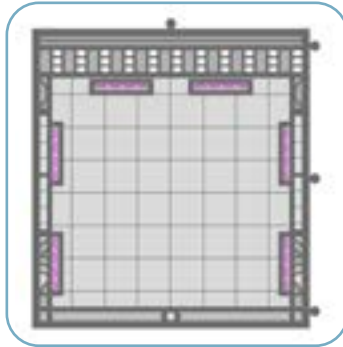

12900-05

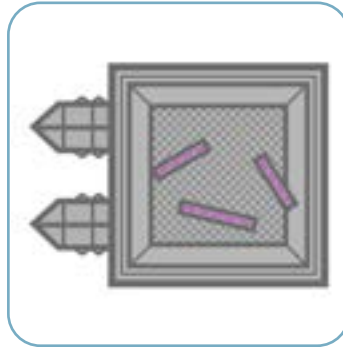

12900-06

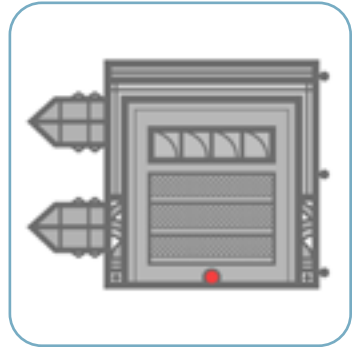

12900-11

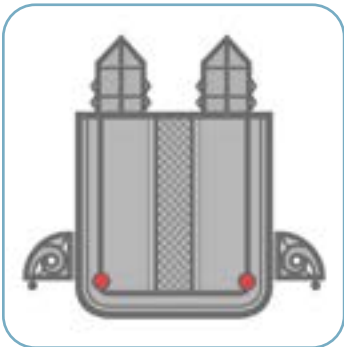

12900-12

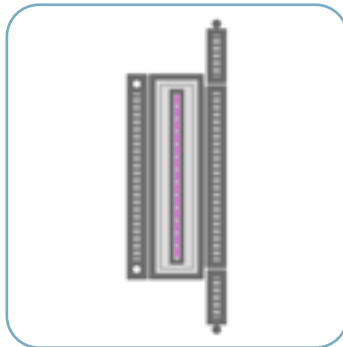

12900-13

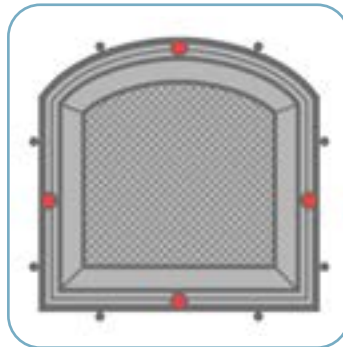

12900-14

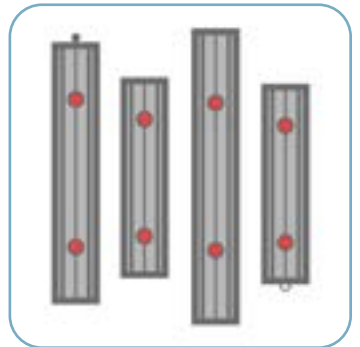

 = 2 MM

 = 3 MM

 = 4 MM

CRAFT KNIFE



## ATTENTION

When printing this document, any page scaling or page fitting options in your print dialog box must be turned OFF or set to NONE so that your files will print out at their actual size. Images not printed at actual size will not function as intended.

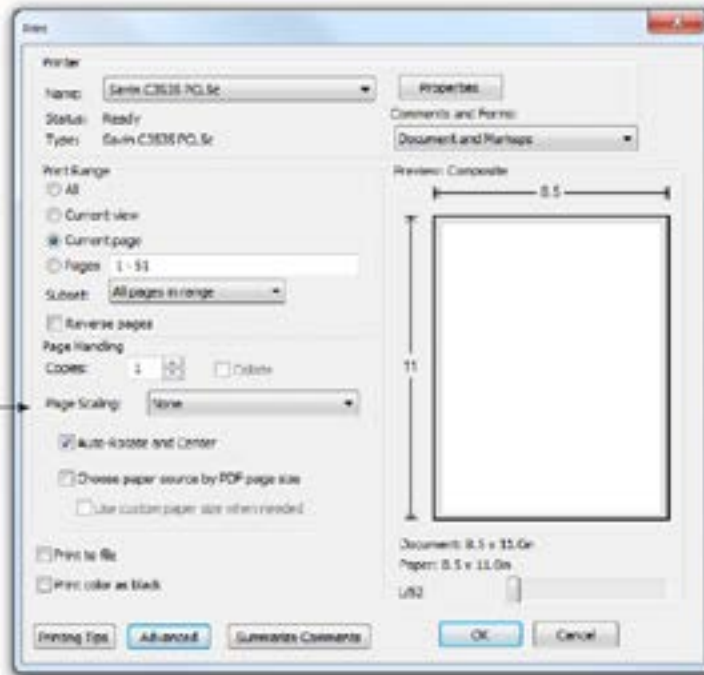

## TO SAVE PAPER

Only print the desired image by navigating to the image's page, go to File > Print and select "Current page" in the print dialog box. Repeat for each desired image.



# APPLIQUE PATTERNS



Print at 100%. No scaling. This box measures 1" x 1". Use the box as an accuracy guide when printing templates.

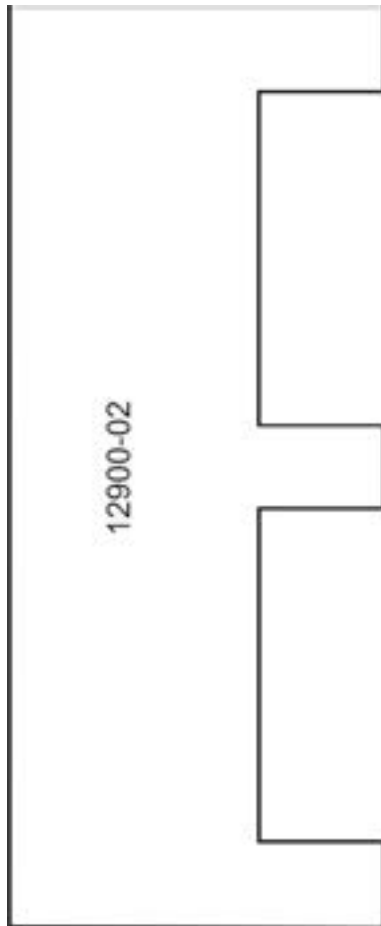
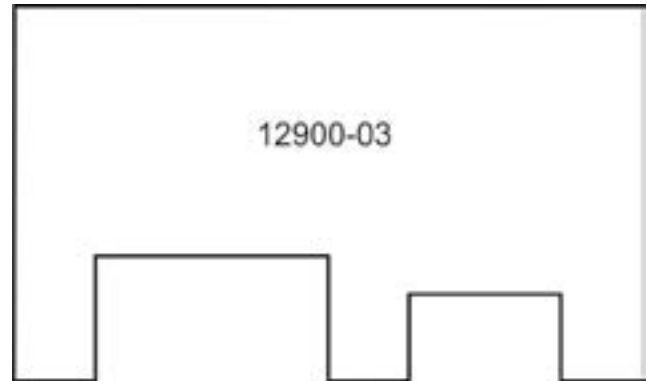
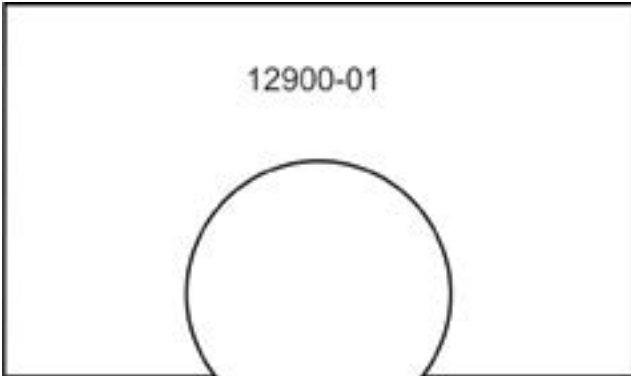

# APPLIQUE PATTERNS



Print at 100%. No scaling. This box measures 1" x 1". Use the box as an accuracy guide when printing templates.

12900-05

12900-07

Cut Out

12900-06

12900-08

12900-08



# APPLIQUE PATTERNS



Print at 100%. No scaling. This box measures 1" x 1". Use the box as an accuracy guide when printing templates.

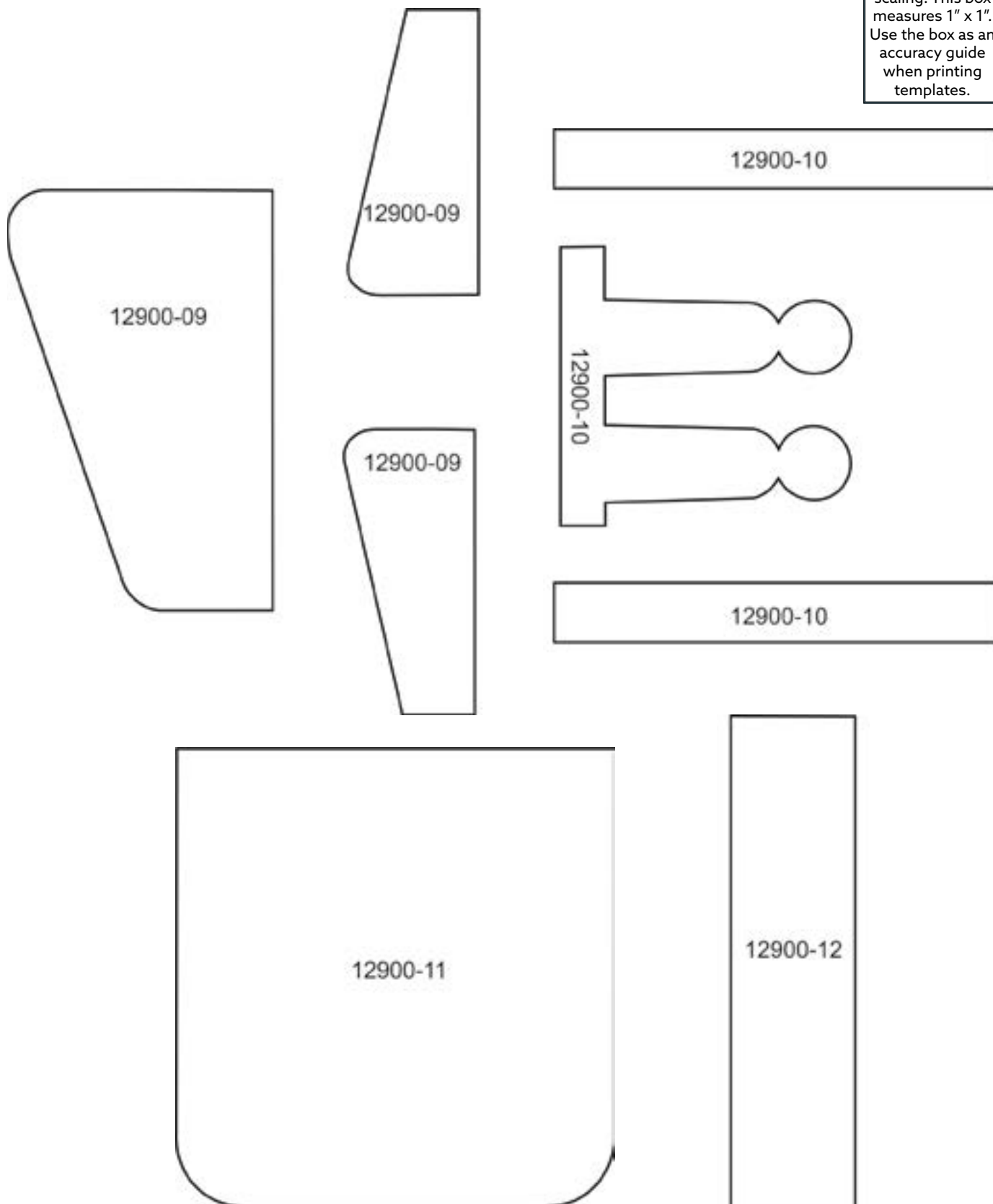

# APPLIQUE PATTERNS



Print at 100%. No scaling. This box measures 1" x 1". Use the box as an accuracy guide when printing templates.

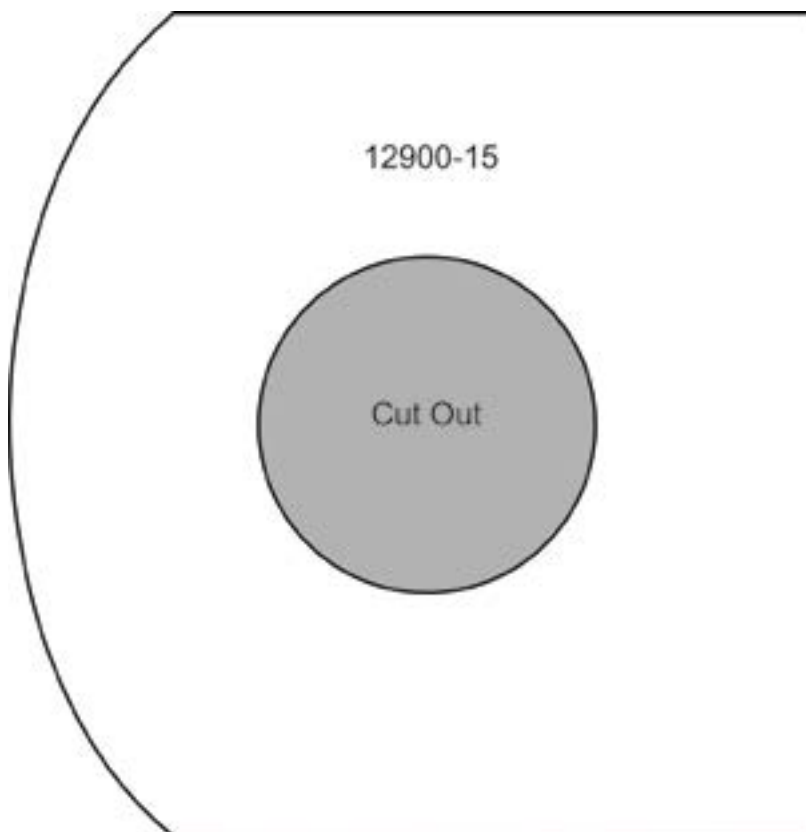
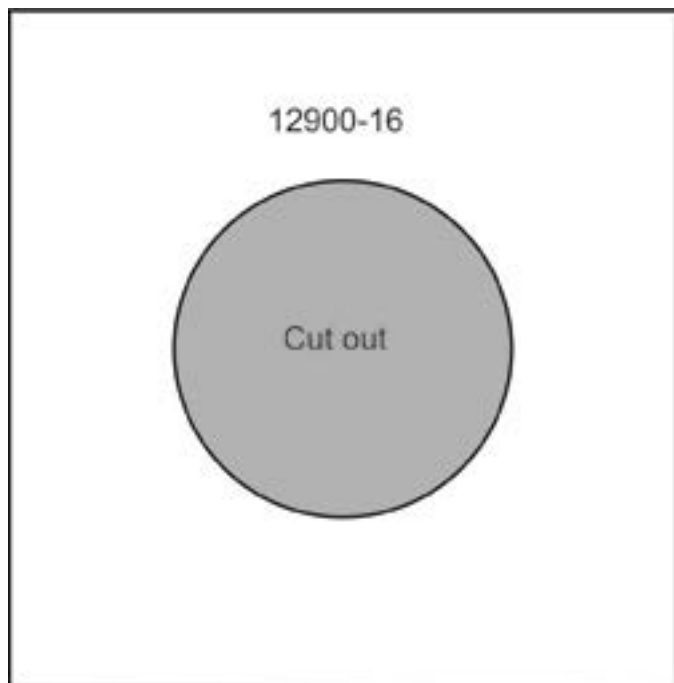

# APPLIQUE PATTERNS



Print at 100%. No scaling. This box measures 1" x 1". Use the box as an accuracy guide when printing templates.

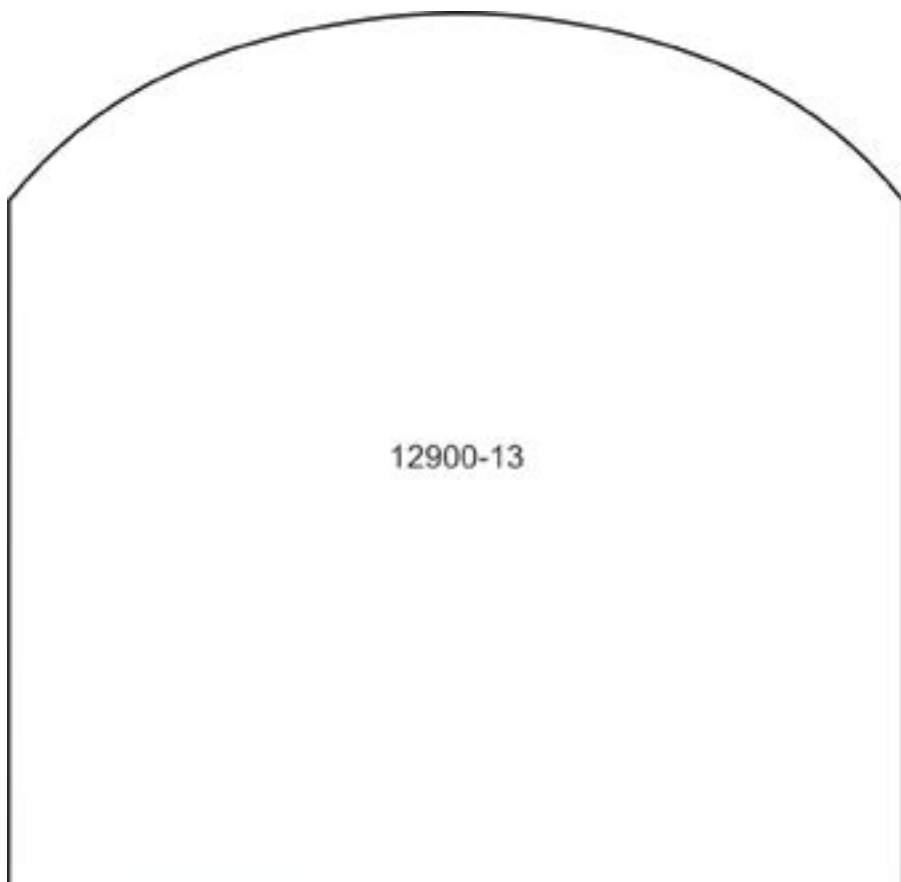

# APPLIQUE PATTERNS



Print at 100%. No scaling. This box measures 1" x 1". Use the box as an accuracy guide when printing templates.

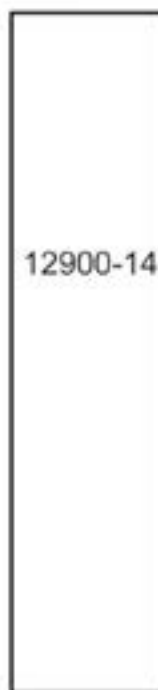
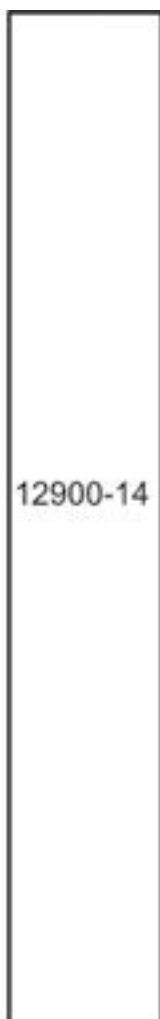
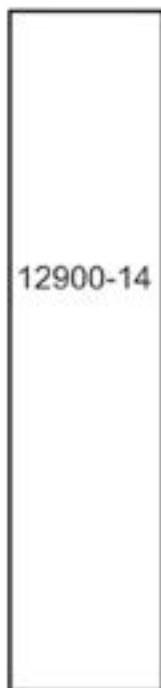
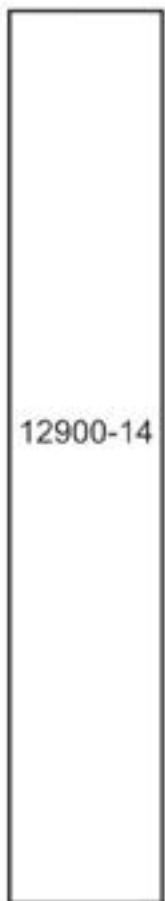

# MIRRORED PATTERNS



Print at 100%. No scaling. This box measures 1" x 1". Use the box as an accuracy guide when printing templates.

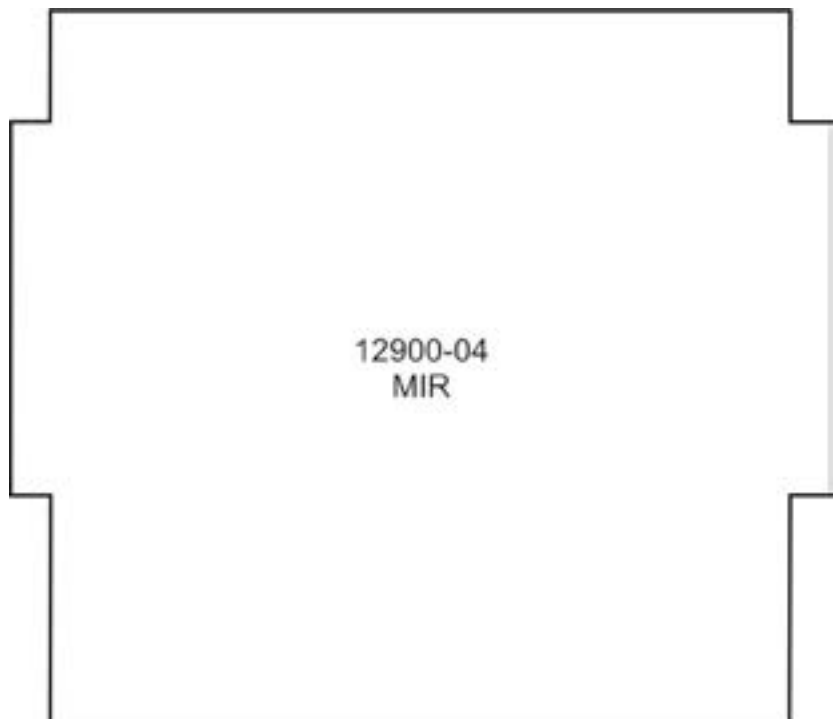
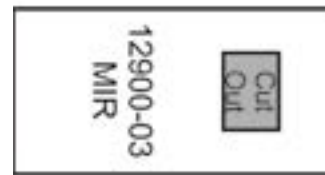
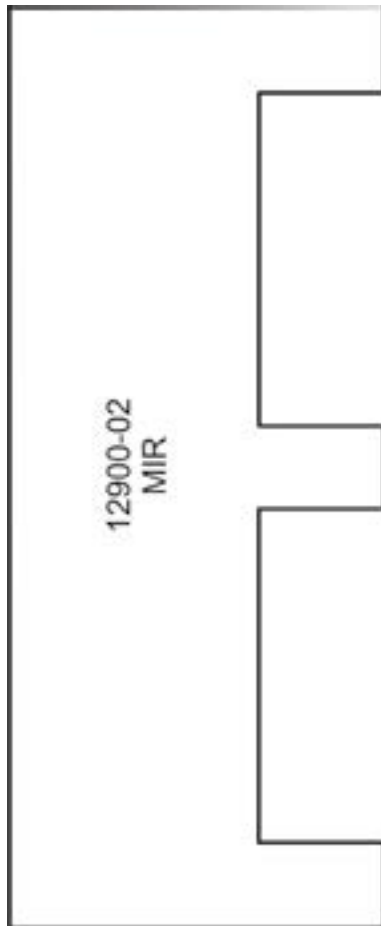
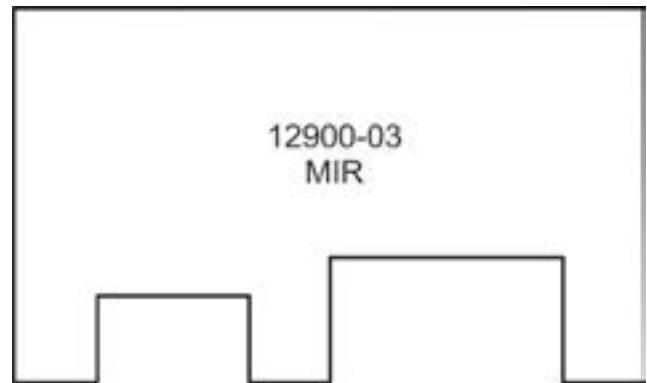
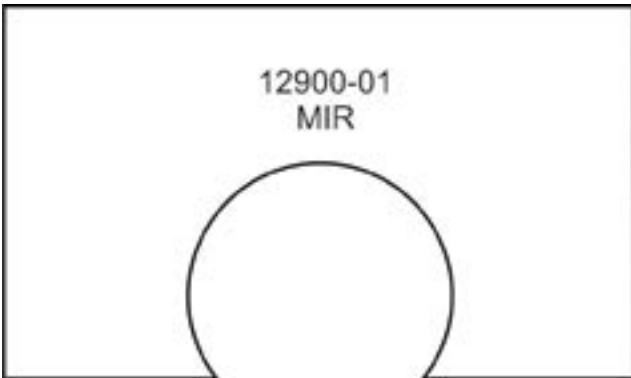

# MIRRORED PATTERNS



Print at 100%. No scaling. This box measures 1" x 1". Use the box as an accuracy guide when printing templates.

12900-05  
MIR

12900-07  
MIR

Cut Out

12900-06  
MIR

12900-08  
MIR

12900-08  
MIR

# MIRRORED PATTERNS



Print at 100%. No scaling. This box measures 1" x 1". Use the box as an accuracy guide when printing templates.



12900-09  
MIR



12900-09  
MIR

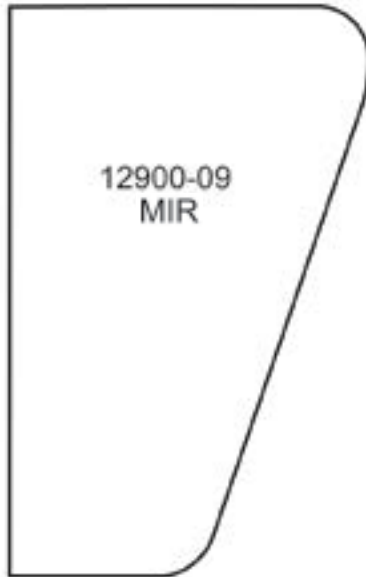

12900-09  
MIR

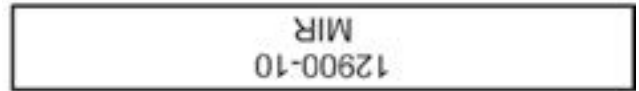

12900-10  
MIR

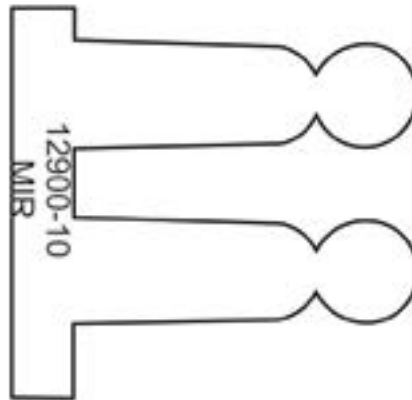

12900-10  
MIR



12900-10  
MIR

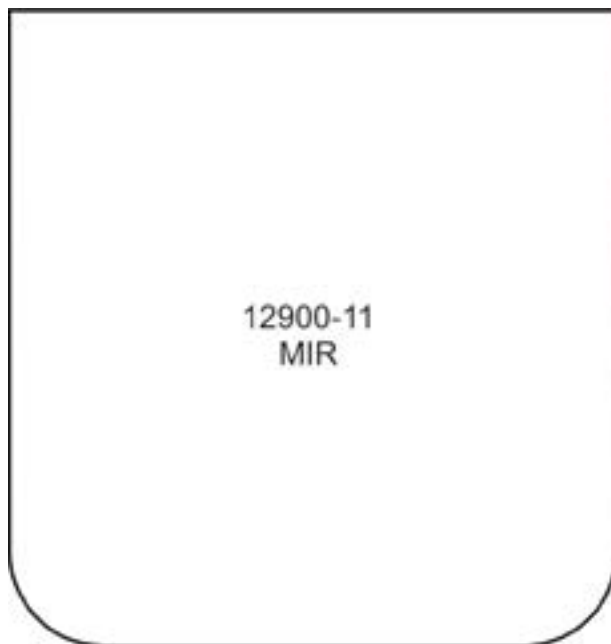

12900-11  
MIR

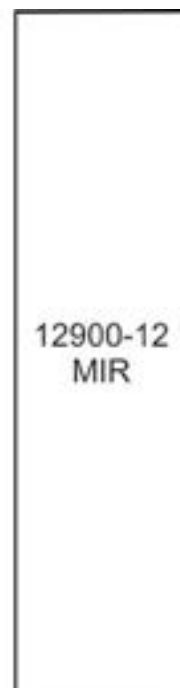

12900-12  
MIR

# MIRRORED PATTERNS



Print at 100%. No scaling. This box measures 1" x 1". Use the box as an accuracy guide when printing templates.

12900-13  
MIR



# MIRRORED PATTERNS



Print at 100%. No scaling. This box measures 1" x 1". Use the box as an accuracy guide when printing templates.

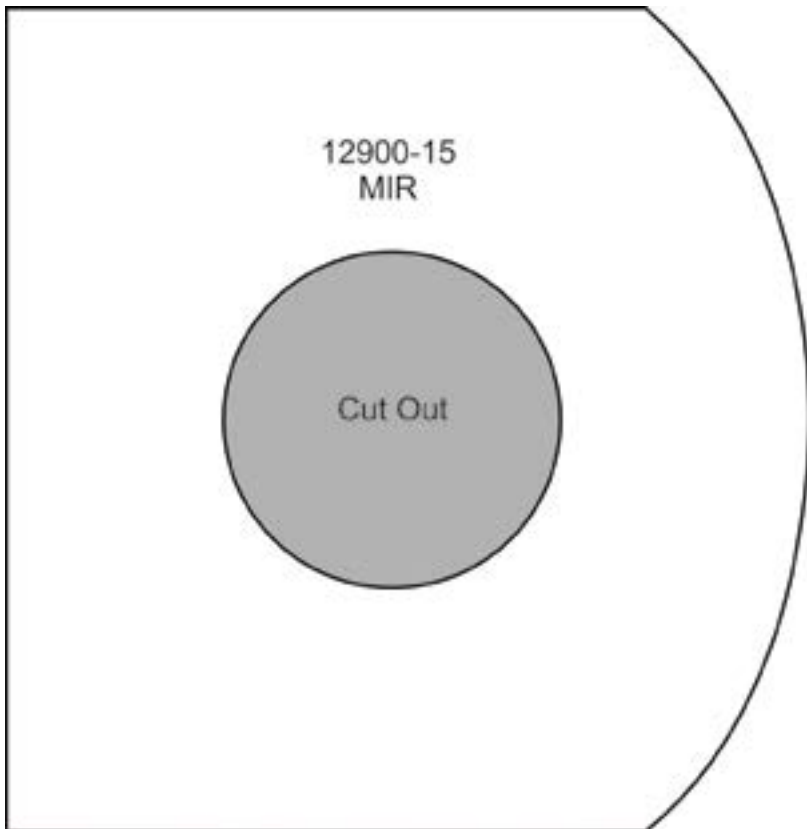
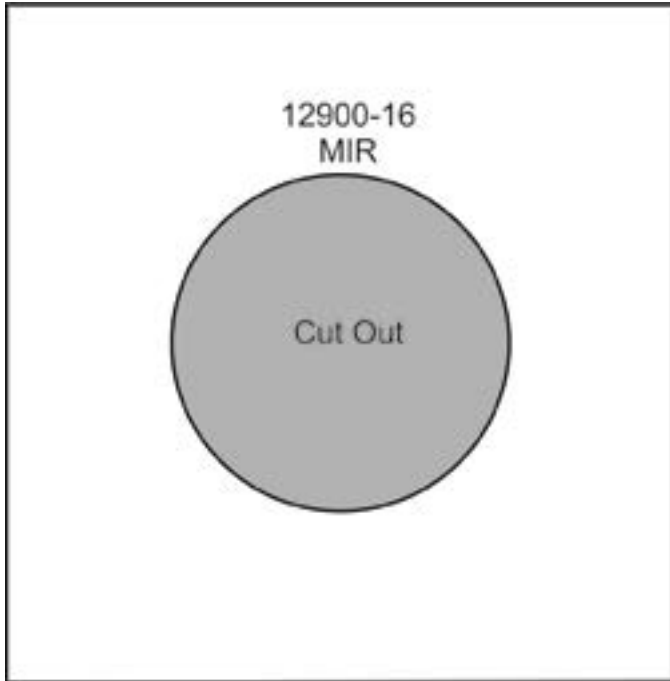

# MIRRORED PATTERNS



Print at 100%. No scaling. This box measures 1" x 1". Use the box as an accuracy guide when printing templates.

12900-14  
MIR

12900-14  
MIR

12900-14  
MIR

12900-14  
MIR