

HAPPY EASTER BANNER



1

Design

THREAD LIST



Isacord Thread Colors

0015 White	1030 Passion Fruit	2650 Impatiens
0020 Black	1060 Shrimp Pink	3030 Amethyst
0112 Leadville	2171 Blush	5610 Bright Mint
0250 Lemon Frost	2530 Rose	5650 Spring Frost
0310 Yellow	2560 Azalea Pink	

*** Project instructions included after design list.**

Note: One spool of 1000 meter thread is adequate for the project unless otherwise noted.

TABLE OF CONTENTS

Interactive Menu

Click to navigate to section.

Designs.....	3
Collection Supplies.....	12
Summary	13
Embroidery	14
Assembly	19
Printing Instructions.....	25
Applique Patterns.....	26
Mirrored Patterns	30

Note: Some designs in this collection may have been created using unique special stitches and/or techniques. To preserve design integrity when rescaling or rotating designs in your software, always rescale or rotate designs using the handles directly on-screen.

12912-01 Tile 1

Size Inches:	Size mm:	Stitch Count:
10.50 X 1.50 in.	266.7 X 38.1 mm	5981 St.

- 1. Yellow Detail 0310
- 2. White Detail 0015
- 3. Seam Stitch/Match Fabric 0020



12912-02 Tile 2

Size Inches:	Size mm:	Stitch Count:
10.48 X 1.50 in.	266.2 X 38.1 mm	5522 St.

- 1. Yellow Detail 0310
- 2. White Detail 0015
- 3. Seam Stitch/Match Fabric 0020



Note: Some designs in this collection may have been created using unique special stitches and/or techniques. To preserve design integrity when rescaling or rotating designs in your software, always rescale or rotate designs using the handles directly on-screen.

12912-03 Tile 3

Size Inches: Size mm: Stitch Count:
10.51 X 1.50 in. **267.0 X 38.1 mm** **6971 St.**

- 1. Yellow Detail 0310
- 2. White Detail 0015
- 3. Seam Stitch/Match Fabric 0020



***Fabric Required**

12912-04 Tile 4 Applique

Size Inches: Size mm: Stitch Count:
7.75 X 5.25 in. **196.9 X 133.4 mm** **20729 St.**

- 1. Yellow Fabric Placement Stitch 2650
- 2. Cut Line and Tackdown 2650
- 3. Purple Fabric Placement Stitch 2650
- 4. Cut Line and Tackdown 2650
- 5. Pink Detail 2650
- 6. Orange Detail 1030
- 7. Gray Eyes 0112
- 8. Green Detail 5650
- 9. Light Green Detail 5650
- 10. Dark Pink Detail 2530
- 11. Light Pink Detail 2171
- 12. White Detail 0015
- 13. Yellow Detail 0310
- 14. Purple Cover Stitch 3030
- 15. White Detail 0015
- 16. Seam Stitch/Match Fabric 0020



Note: Some designs in this collection may have been created using unique special stitches and/or techniques. To preserve design integrity when rescaling or rotating designs in your software, always rescale or rotate designs using the handles directly on-screen.

***Fabric Required**

12912-05 Tile 5 Applique



Size Inches: Size mm: Stitch Count:
5.51 X 5.00 in. 139.9 X 127.0 mm 19114 St.

- 1. Purple Fabric Placement Stitch 2650
- 2. Cut Line and Tackdown 2650
- 3. Pink Detail 2650
- 4. Green Detail 5610
- 5. Light Green Detail 5650
- 6. Dark Pink Detail..... 2530
- 7. Yellow Detail..... 0310
- 8. Light Yellow Detail 0250
- 9. White Flower Center..... 0015
- 10. Orange Detail 1030
- 11. Purple Cover Stitch 3030
- 12. White Letter Detail..... 0015
- 13. Seam Stitch/Match Fabric 0020

***Fabric Required**

12912-06 Tile 6 Applique



Size Inches: Size mm: Stitch Count:
5.50 X 5.25 in. 139.7 X 133.4 mm 17035 St.

- 1. Purple Fabric Placement Stitch 2560
- 2. Cut Line and Tackdown 2650
- 3. Pink Detail 2650
- 4. Dark Pink Detail..... 2530
- 5. Light Yellow Detail 0250
- 6. Yellow Detail..... 0310
- 7. Light Pink Detail 2171
- 8. Green Detail 5610
- 9. Light Green Detail 5650
- 10. Purple Cover Stitch 3030
- 11. White Letter Detail..... 0015
- 12. Orange Detail 1030
- 13. White Egg Detail..... 0015
- 14. Seam Stitch/Match Fabric 0020

Note: Some designs in this collection may have been created using unique special stitches and/or techniques. To preserve design integrity when rescaling or rotating designs in your software, always rescale or rotate designs using the handles directly on-screen.

***Fabric Required**

12912-07 Tile 7 Applique



Size Inches: Size mm: Stitch Count:
5.51 X 5.25 in. 139.8 X 133.4 mm 19957 St.

- 1. Purple Fabric Placement Stitch 2650
- 2. Cut Line and Tackdown 2650
- 3. Pink Detail 2650
- 4. Yellow Detail 0310
- 5. Light Yellow Detail 0250
- 6. Dark Pink Detail 2530
- 7. Light Pink Detail 2171
- 8. Green Detail 5610
- 9. Light Green Detail 5650
- 10. White Detail 0015
- 11. Purple Cover Stitch 3030
- 12. White Letter Detail 0015
- 13. Seam Stitch/Match Fabric 0020

***Fabric Required**

12912-08 Tile 8 Applique



Size Inches: Size mm: Stitch Count:
8.00 X 5.00 in. 203.2 X 127.0 mm 21813 St.

- 1. Purple Fabric Placement Stitch 2650
- 2. Cut Line and Tackdown 2650
- 3. Pink Detail 2650
- 4. Green Detail 5610
- 5. Light Green Detail 5650
- 6. Dark Pink Detail 2530
- 7. Orange Detail 1030
- 8. Light Orange Detail 1060
- 9. Yellow Detail 0310
- 10. Light Yellow Detail 0250
- 11. White Detail 0015
- 12. Purple Cover Stitch 3030
- 13. White Letter Detail 0015
- 14. Seam Stitch/Match Fabric 0020

Note: Some designs in this collection may have been created using unique special stitches and/or techniques. To preserve design integrity when rescaling or rotating designs in your software, always rescale or rotate designs using the handles directly on-screen.

***Fabric Required**

12912-09 Tile 9 Applique



Size Inches: Size mm: Stitch Count:
5.50 X 5.00 in. 139.7 X 127.0 mm 15759 St.

- 1. Purple Fabric Placemmnt Stitch 2650
- 2. Cut Line and Tackdown 2650
- 3. Pink Detail 2650
- 4. Green Detail 5610
- 5. Light Green Detail 5650
- 6. Dark Pink Detail..... 2530
- 7. Light Pink Detail 2171
- 8. Yellow Detail..... 0310
- 9. Light Yellow Detail 0250
- 10. Purple Cover Stitch 3030
- 11. White Letter Detail..... 0015
- 12. Seam Stitch/Match Fabric 0020

***Fabric Required**

12912-10 Tile 10 Applique



Size Inches: Size mm: Stitch Count:
5.51 X 5.25 in. 139.9 X 133.4 mm 20408 St.

- 1. Purple Fabric Placement Stitch 2650
- 2. Cut Line and Tackdown 2650
- 3. Pink Detail 2650
- 4. Yellow Detail..... 0310
- 5. Light Yellow Detail 0250
- 6. Orange Detail 1030
- 7. Light Orange Detail 1060
- 8. Pink Detail 2530
- 9. Light Pink Detail 2171
- 10. Purple Butterfly..... 3030
- 11. White Detail 0015
- 12. Green Detail 5610
- 13. Light Green Detail 5650
- 14. Purple Cover Stitch 3030
- 15. White Letter Detail..... 0015
- 16. Seam Stitch/Match Fabric 0020

Note: Some designs in this collection may have been created using unique special stitches and/or techniques. To preserve design integrity when rescaling or rotating designs in your software, always rescale or rotate designs using the handles directly on-screen.

***Fabric Required**

12912-11 Tile 11 Applique



Size Inches: 5.58 X 5.25 in. Size mm: 141.8 X 133.4 mm Stitch Count: 20294 St.

	1. Purple Fabric Placement Stitch	2650
	2. Cut Line and Tackdown	2650
	3. Pink Detail	2650
	4. Dark Pink Detail.....	2530
	5. Yellow Detail	0310
	6. Light Yellow Detail	0250
	7. Orange Detail	1030
	8. Light Orange Detail	1060
	9. White Detail	0015
	10. Light Pink Detail	2171
	11. Green Detail	5610
	12. Light Green Detail	5650
	13. Purple Cover Stitch	3030
	14. White Letter Detail.....	0015
	15. Seam Stitch/Match Fabric	0020

***Fabric Required**

12912-12 Tile 12 Applique



Size Inches: 5.50 X 5.25 in. Size mm: 139.7 X 133.4 mm Stitch Count: 18047 St.

	1. Purple Fabric Placement Stitch	2650
	2. Cut Line and Tackdown	2650
	3. Pink Detail	2650
	4. Green Detail	5610
	5. Light Green Detail	5650
	6. Yellow Detail	0310
	7. Light Yellow Detail	0250
	8. Orange Detail	1030
	9. Light Orange Detail	1060
	10. Purple Cover Stitch	3030
	11. White Letter Detail.....	0015
	12. Dark Pink Detail.....	2530
	13. Light Pink Detail	2171
	14. Seam Stitch/Match Fabric	0020



















Note: Some designs in this collection may have been created using unique special stitches and/or techniques. To preserve design integrity when rescaling or rotating designs in your software, always rescale or rotate designs using the handles directly on-screen.

***Fabric Required**

12912-13 Tile 13 Applique



Size Inches: Size mm: Stitch Count:
5.50 X 5.25 in. 139.8 X 133.3 mm 20609 St.

	1. Purple Fabric Placement Stitch	2650
	2. Cut Line and Tackdown	2650
	3. Pink Detail	2650
	4. White Detail	0015
	5. Yellow Detail	0310
	6. Light Yellow Detail	0250
	7. Yellow Detail	0310
	8. Orange Detail	1030
	9. Light Orange Detail	1060
	10. Dark Pink Detail.....	2530
	11. Light Pink Detail	2171
	12. White Detail	0015
	13. Light Orange Detail	1060
	14. Green Detail	5610
	15. Light Green Detail	5650
	16. Purple Cover Stitch	3030
	17. White Letter Detail.....	0015
	18. Seam Stitch/Match Fabric	0020

Note: Some designs in this collection may have been created using unique special stitches and/or techniques. To preserve design integrity when rescaling or rotating designs in your software, always rescale or rotate designs using the handles directly on-screen.

***Fabric Required**

12912-14 Tile 14 Applique



Size Inches: Size mm: Stitch Count:
5.51 X 5.24 in. 139.8 X 133.0 mm 16290 St.

- 1. Purple Fabric Placement Stitch 2650
- 2. Cut Line and Tackdown 2650
- 3. Pink Detail 2650
- 4. White Detail 0015
- 5. Yellow Detail 0310
- 6. Light Yellow Detail 0250
- 7. Orange Detail 1030
- 8. Light Orange Detail 1060
- 9. Green Detail 5610
- 10. Light Green Detail 5650
- 11. Dark Pink Detail..... 2530
- 12. Light Pink Detail 2171
- 13. Purple Cover Stitch 3030
- 14. White Letter Detail 0015
- 15. Seam Stitch/Match Fabric 0020

12912-15 Tile 15

Size Inches: Size mm: Stitch Count:
10.51 X 1.50 in. 267.0 X 38.1 mm 6969 St.

- 1. Yellow Detail 0310
- 2. White Detail 0015
- 3. Seam Stitch/Match Fabric 0020



Note: Some designs in this collection may have been created using unique special stitches and/or techniques. To preserve design integrity when rescaling or rotating designs in your software, always rescale or rotate designs using the handles directly on-screen.

12912-16 Tile 16

Size Inches:	Size mm:	Stitch Count:
10.48 X 1.50 in.	266.2 X 38.1 mm	5518 St.

	1. Yellow Detail	0310
	2. White Detail	0015
	3. Seam Stitch/Match Fabric	0020

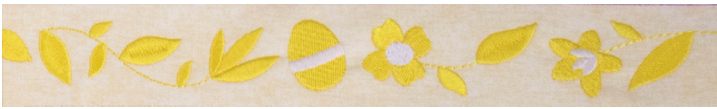

12912-17 Tile 17

Size Inches:	Size mm:	Stitch Count:
10.50 X 1.50 in.	266.7 X 38.1 mm	5977 St.

	1. Yellow Detail	0310
	2. White Detail	0015
	3. Seam Stitch/Match Fabric	0020



Stabilizers

- OESD Fusible Woven 20"
- OESD Medium Weight TearAway 20" (1 roll)

Fabrics/Textiles

- ¼ yard Purple quilter's cotton
- ½ yard Light Yellow quilter's cotton
- ½ yard Light Purple quilter's cotton
- ½ yard Light Green quilter's cotton
- Backing ½ yard
- Binding ¼ yard, cut 3 strips width of fabric x 2 ½" strips, stitch together at 45° angle to create one long strip.

Note: Fabric sizes are estimates and may result in overage.

Notions & Tools

- OESD Expert Point and Press Tool
- OESD Perfect Embroidery Press Cloth
- 505 Temporary Spray Adhesive
- Ruler, rotary cutter, mat
- Contrasting bobbin thread (seam stitch only, may be different colors)
- Fabric marking pen
- Embroidery Needle Sharp 75/11
- Walking foot
- Dual feed foot

Isacord Thread Colors

- Per thread chart

SUMMARY



Completed Size: 12 x 30 in.

Notes

The applique instructions, included in the collection, are general instructions. For demonstration purposes, a sample design that best demonstrates the technique is shown.

Fabric and thread requirements will vary by design, but the general technique is the same.

Note: Some thread colors in instructions have been changed or digitally enhanced for better visibility.

STEP 1

- Embroider one of each design file 12912-01 through 12912-17.
- For each hooping, cut the following 10" x 15", or large enough to hoop:
 - 1 layer of Fusible Woven
 - 2 layers of Medium Weight TearAway
 - 1 layer of background fabric

Note: To economize on fabric, cut the fabric 20" wide (or the height of the hoop + 2") x width of the fabric. Apply the stabilizers. Move the hoop down the length of the fabric as each block is stitched. Leave a minimum of 1.5" between the blocks.



STEP 2

- Apply one layer of Fusible Woven to the wrong side of the applique fabric.



STEP 3

- Load selected design into the machine.
- Example design is 12912-04.
- Thread the machine per the thread chart.
- Place hoop on the machine.
- Stitch Machine Step 1, Yellow Fabric Placement Stitch.



STEP 4

- Remove the hoop from the machine, but NOT the project from the hoop.
- Completely cover the placement stitch with the prepared fabric.
- Tape in place to secure.
- Return the hoop to the machine.



STEP 5

- Stitch Machine Step 2, Cut Line and Tackdown.



STEP 6

- Remove the hoop from the machine, but NOT the project from the hoop.
- Place on a flat surface.
- Trim the excess fabric as close to the cut line as possible.
- Note: If the outermost stitches (cut line) are cut, the inner stitches (tackdown) will hold the applique in place.
- Return the hoop to the machine.



STEP 7

- Stitch Machine Step 3, Purple Fabric Placement Stitch.



STEP 8

- Remove the hoop from the machine, but NOT the project from the hoop.
- Completely cover the placement stitch with the prepared fabric.
- Tape in place to secure.
- Return the hoop to the machine.



STEP 9

- Stitch Machine Step 4, Cut Line and Tackdown.



STEP 10

- Remove the hoop from the machine, but NOT the project from the hoop.
- Place on a flat surface.
- Trim the excess fabric as close to the cut line as possible.



STEP 11

- Return the hoop to the machine and stitch the remaining steps per the thread chart.



EMBROIDERY



STEP 12

- For each tile, stitch the colors per the thread chart.
- The last color change in each block is called "Seam". This line is the guide when trimming and stitching the tiles together and needs to be highly visible on the back side of the tile.
- Stitch the top color in a thread that blends with the fabric or invisible thread.
- Use a color in the bobbin that contrasts sharply with the wrong side of the tile.

Note: Since the bobbin color does not have to be the same on each tile, this is a great time to use up partially wound bobbins.



STEP 13

- After the embroidery is complete, press each block right side down on a Perfect Embroidery Press Cloth.
- Write the number of the block on the back so it is easily identified during construction.

Tip: Use a pen or pencil that will not bleed through to the front side.

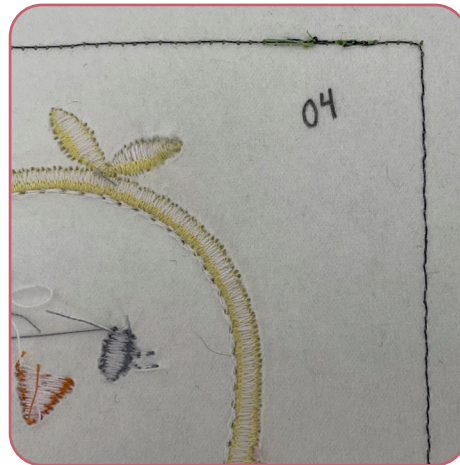
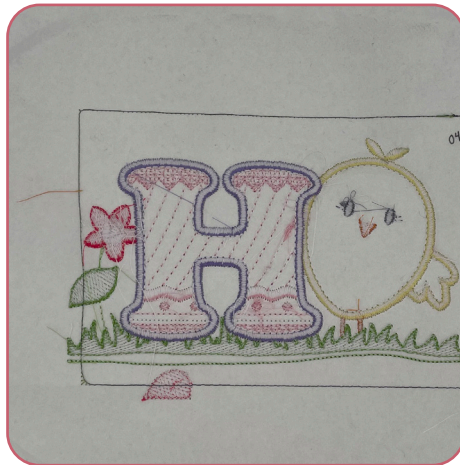

STEP 14

- At the cutting mat, place the block right side down. Identify the "seam" stitch line. Trim 1/2" inch out from the seam stitch line on all four sides to create the seam allowance.

Note: Accuracy will significantly facilitate the construction of the scene.

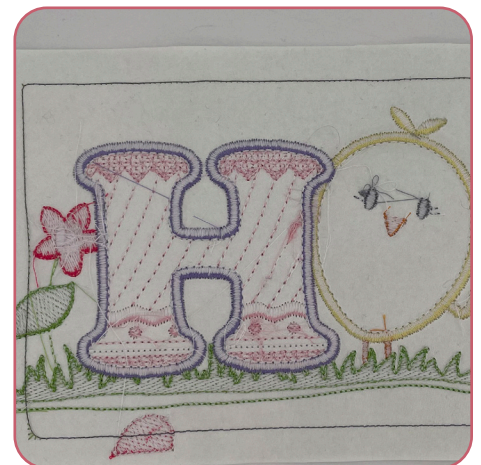

ASSEMBLY



STEP 15

- Arrange the tiles in the layout for the scene.



STEP 16

- Stitch two adjacent tiles, right sides together; the side of one tile to the side of the one next to it.
- Align the matching edges and stitch just inside of the seam line.
- Repeat until all the blocks have been paired.



STEP 17

- Press each seam open.
- Note: If the seams do not come apart easily, press both seam allowances to one side using steam and a cotton or linen setting.
- While warm, open the seam allowance with the large ball of the Expert Point and Press Tool.
- Press again and allow to cool.
- Once cool, remove the excess stabilizer in the seam allowance.
- Do not remove excess stabilizer from inside the seam line.



ASSEMBLY



STEP 18

- Lay out the pressed tiles.
- Pair the connected tiles with the connected tiles to the right.



STEP 19

- Align the center seams.
- Stitch just inside the seam line connecting all four blocks.
- Press seams open.
- Note: If the seams or major points of matching do not match up, try stitching that part first. Check for accuracy. Then stitch across the tiles.



ASSEMBLY



STEP 20

- Finish connecting the block of tiles to the ones below. Press and remove stabilizer. Then continue the stitching and pressing process until the scene is completed.

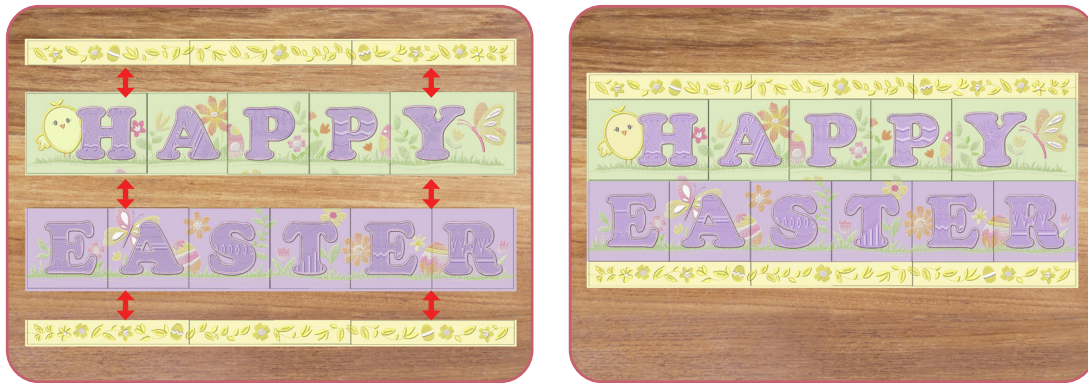

STEP 21

- Cut batting and backing at least 2" larger than the tiling scene.
- Layer the backing (right side down), batting, and tiling scene (right side up).
- Center the tiling scene over the batting and backing.
- Spray baste all layers with temporary spray adhesive.



ASSEMBLY



STEP 22

- Thread the sewing machine with a thread color that blends with the scene or invisible thread.
- Where the tiles connect, stitch in the ditch to attach the batting and backing to the top.
- Tip: For best results use a walking foot or dual feed foot.



STEP 24

- Trim 1/4" from the edge, through all three layers, to square up the finished scene.

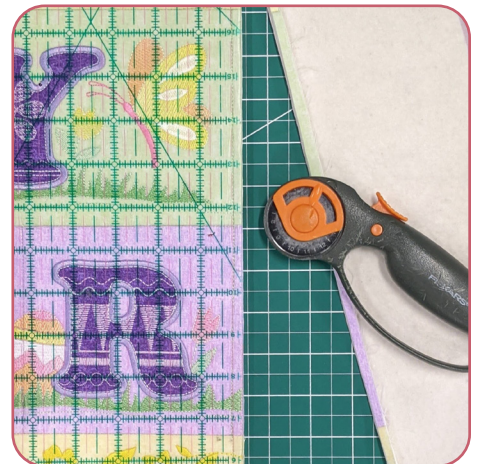

STEP 25

- Zigzag over the raw edges to join the edges together.
- Bind as desired.



ATTENTION

When printing this document, any page scaling or page fitting options in your print dialog box must be turned OFF or set to NONE so that your files will print out at their actual size. Images not printed at actual size will not function as intended.

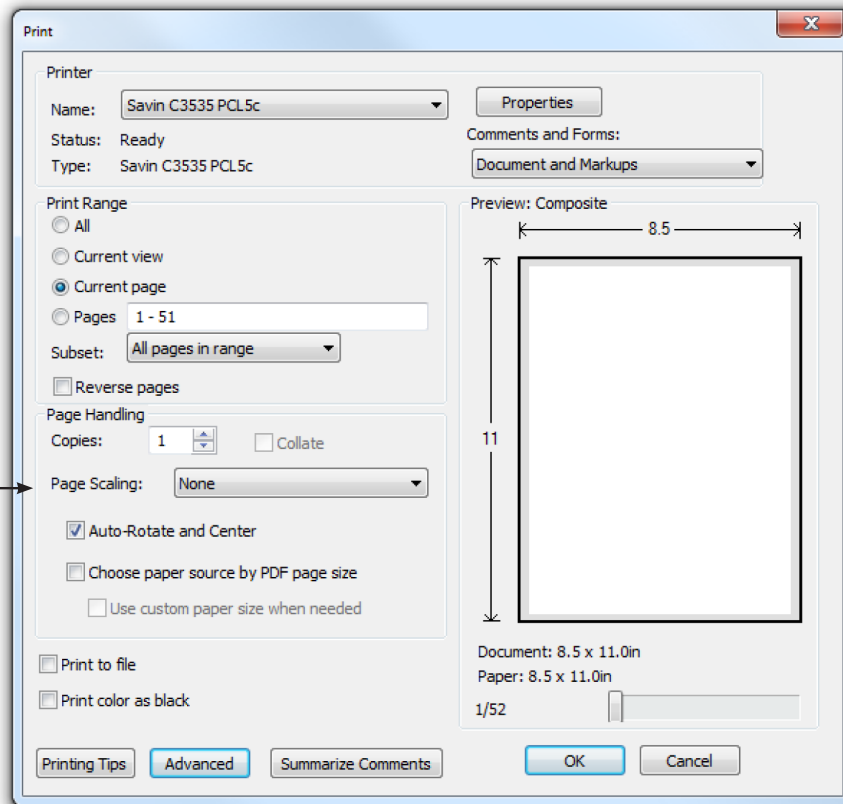

TO SAVE PAPER

Only print the desired image by navigating to the image's page, go to File > Print and select "Current page" in the print dialog box. Repeat for each desired image.

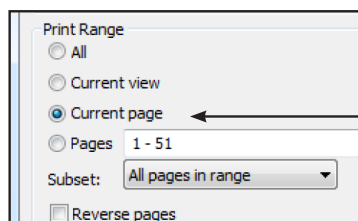

APPLIQUE PATTERNS



Print at 100%. No scaling. This box measures 1" x 1". Use the box as an accuracy guide when printing templates.

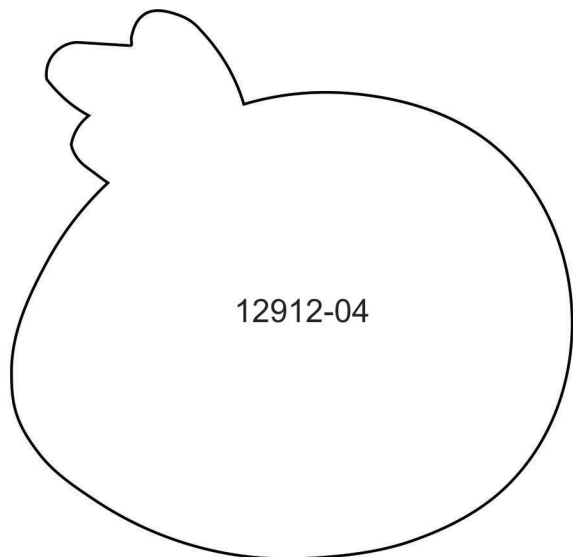

12912-04

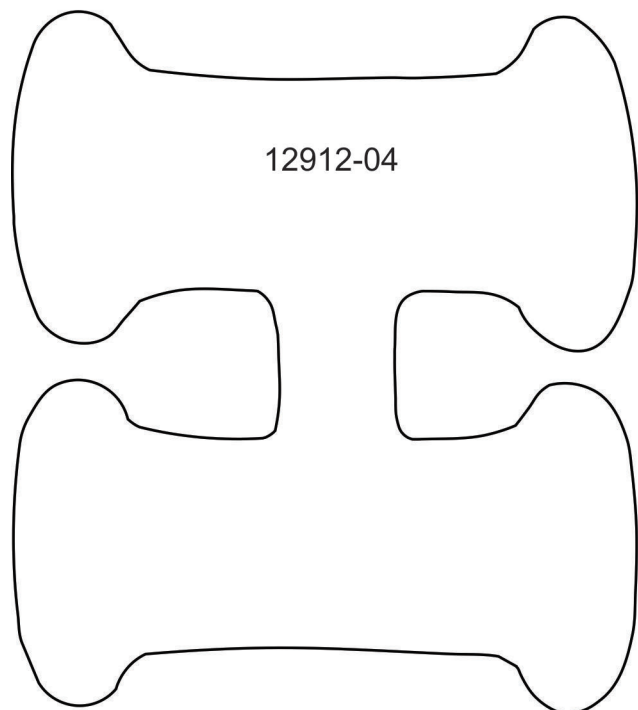

12912-04

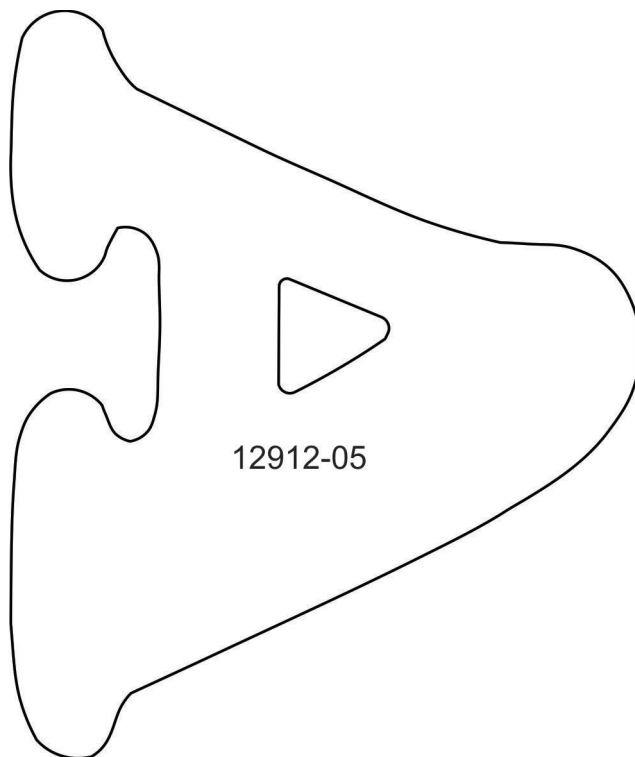

12912-05

APPLIQUE PATTERNS



Print at 100%. No scaling. This box measures 1" x 1". Use the box as an accuracy guide when printing templates.

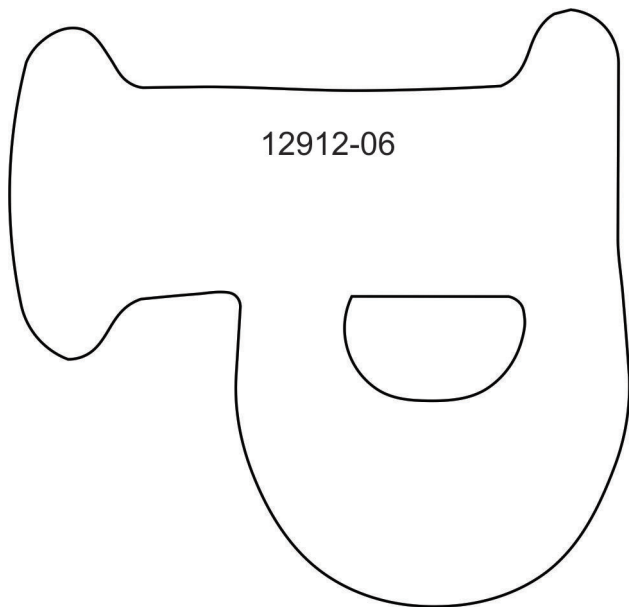

12912-06

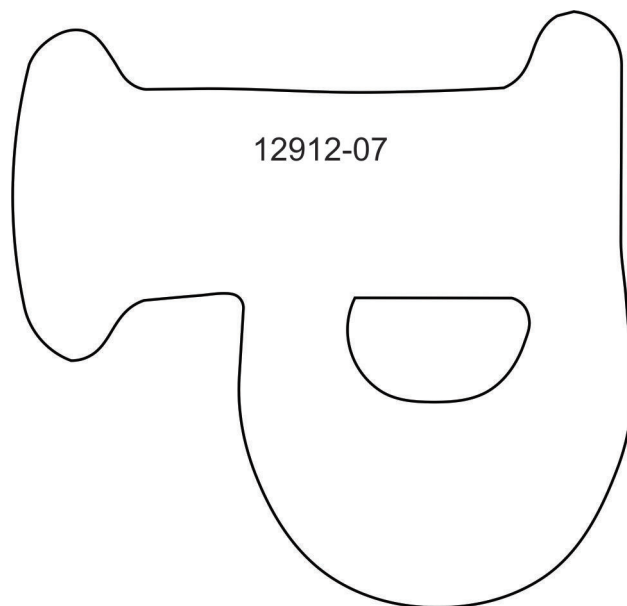

12912-07

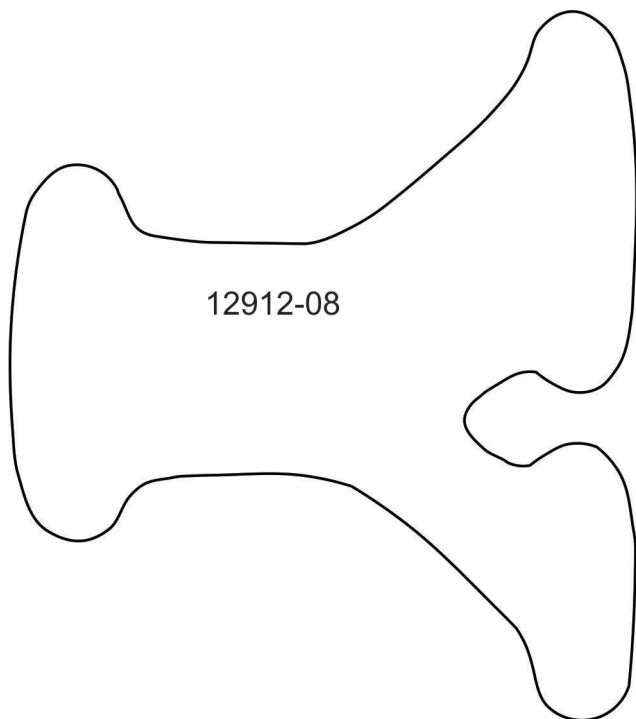

12912-08

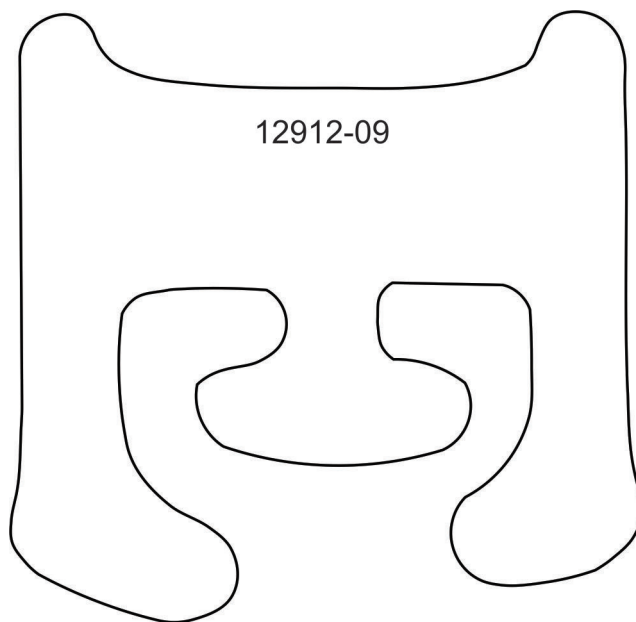

12912-09

APPLIQUE PATTERNS



Print at 100%. No scaling. This box measures 1" x 1". Use the box as an accuracy guide when printing templates.

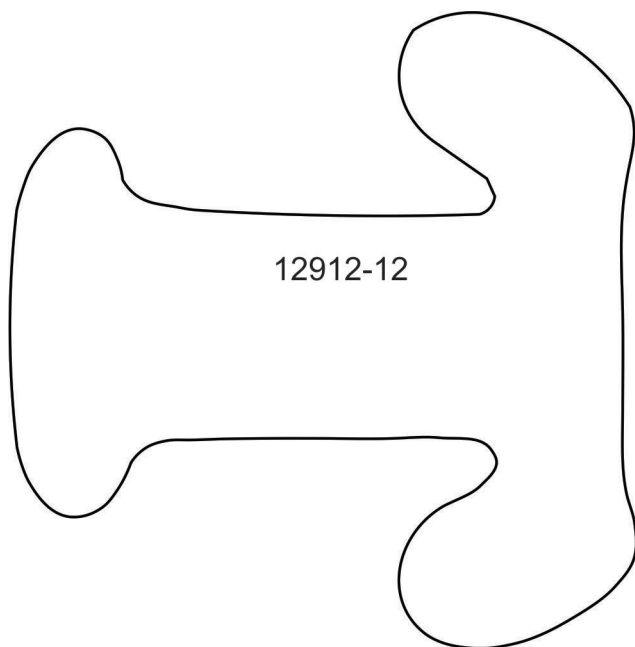
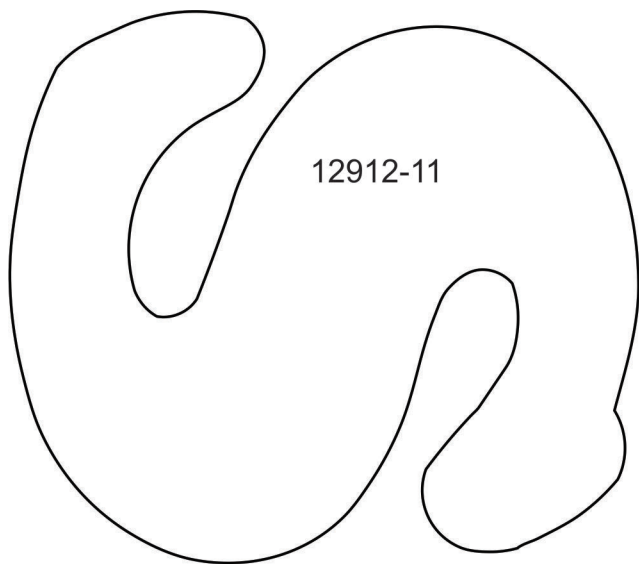
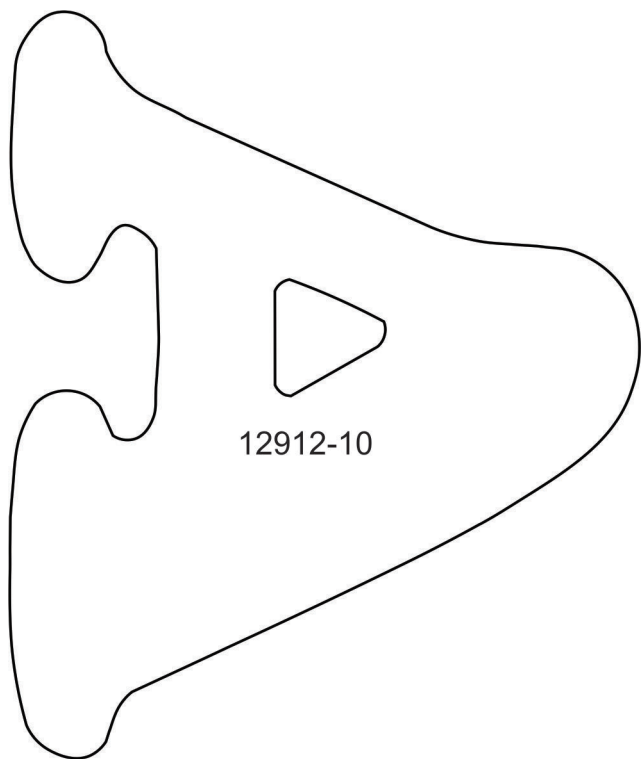

APPLIQUE PATTERNS



Print at 100%. No scaling. This box measures 1" x 1". Use the box as an accuracy guide when printing templates.

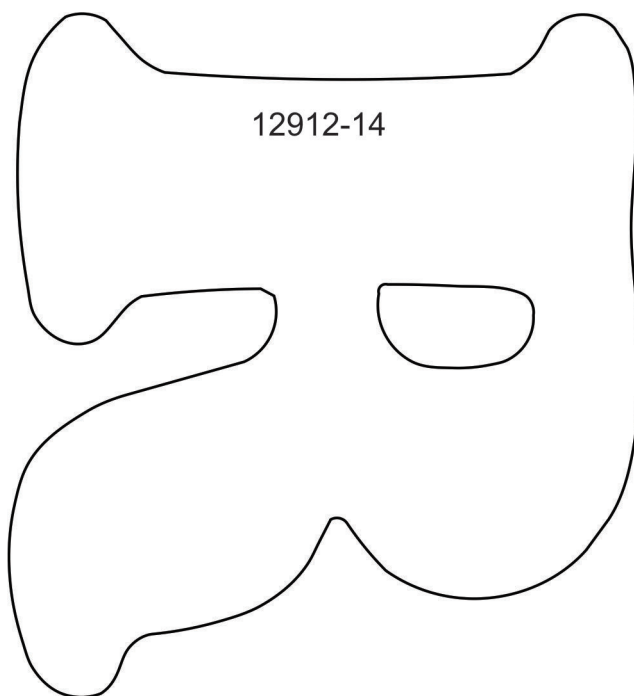
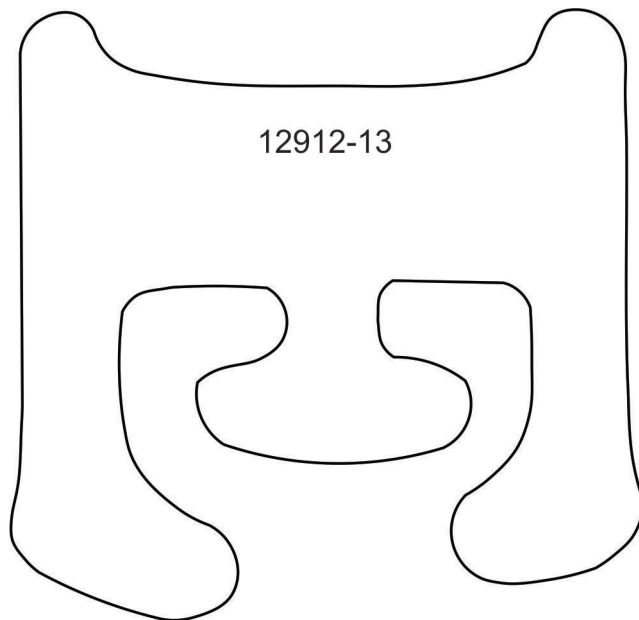

MIRRORED PATTERNS



Print at 100%. No scaling. This box measures 1" x 1". Use the box as an accuracy guide when printing templates.

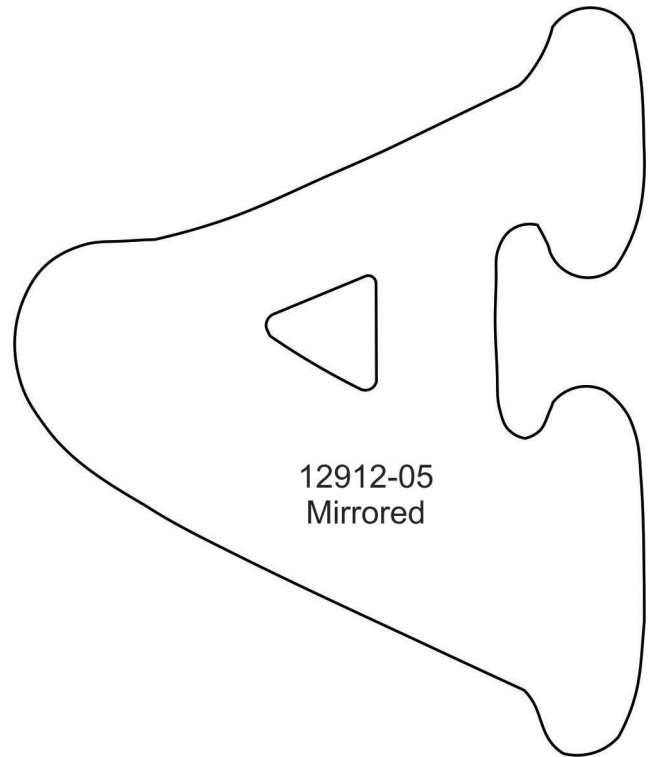
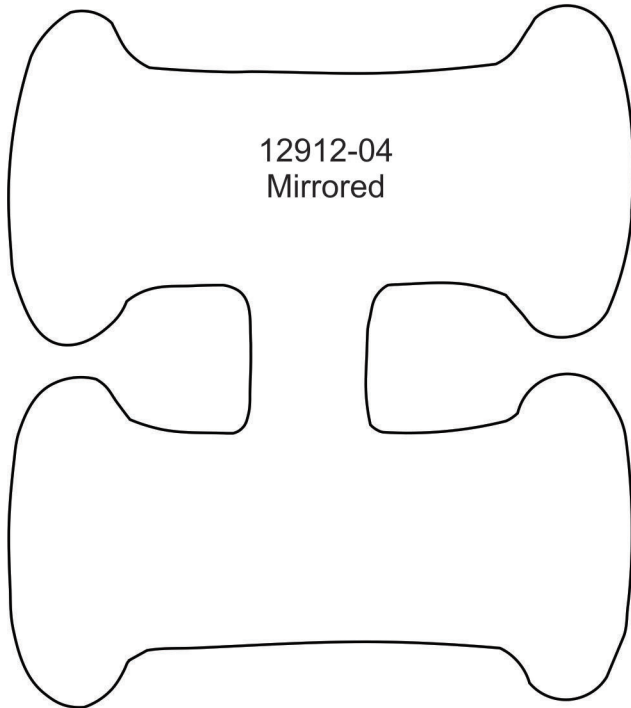
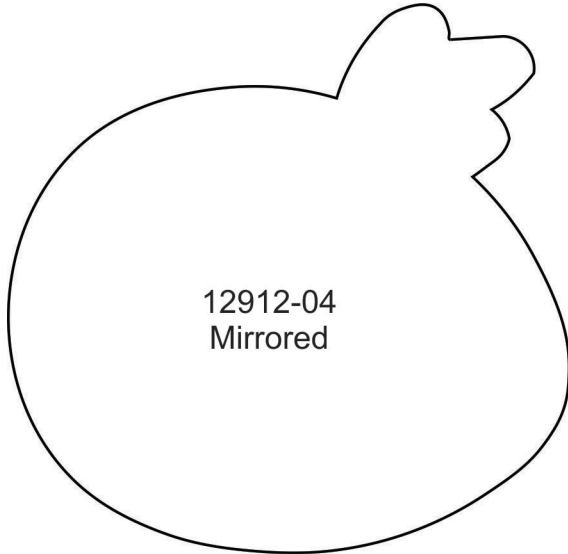

MIRRORED PATTERNS



Print at 100%. No scaling. This box measures 1" x 1". Use the box as an accuracy guide when printing templates.

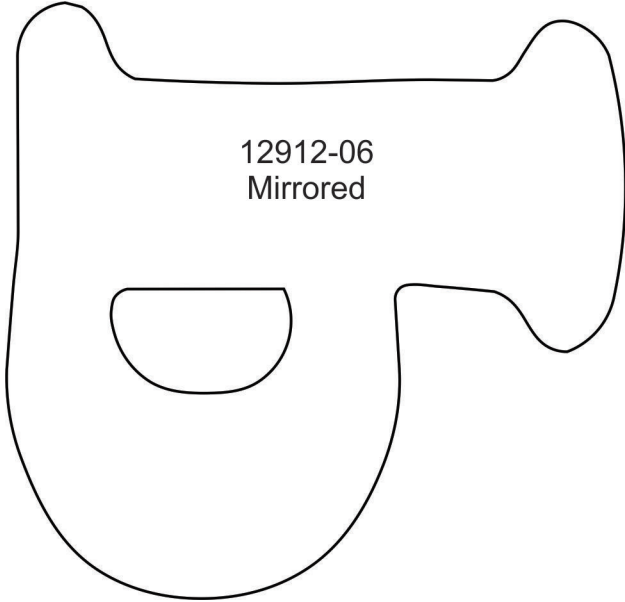

12912-06
Mirrored

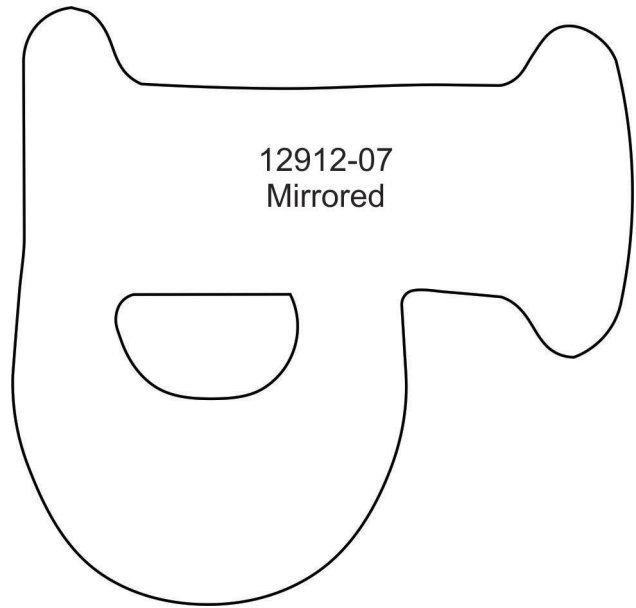

12912-07
Mirrored

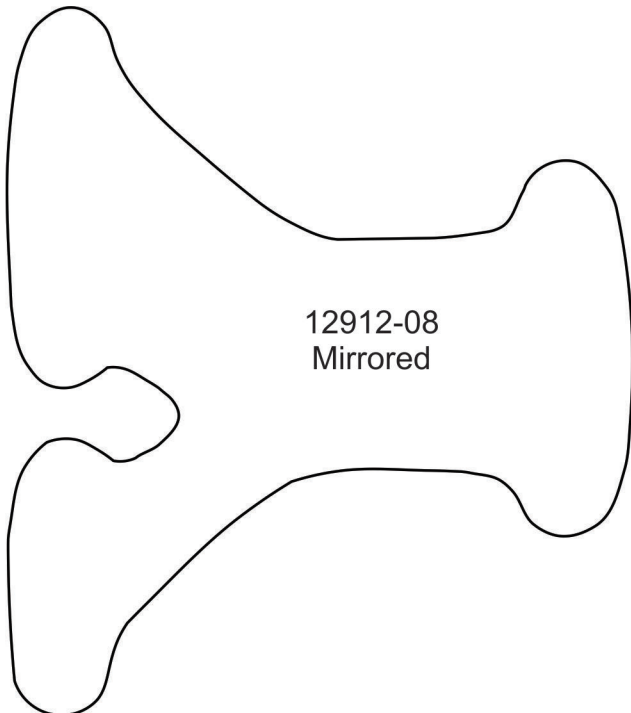

12912-08
Mirrored

MIRRORED PATTERNS



Print at 100%. No scaling. This box measures 1" x 1". Use the box as an accuracy guide when printing templates.

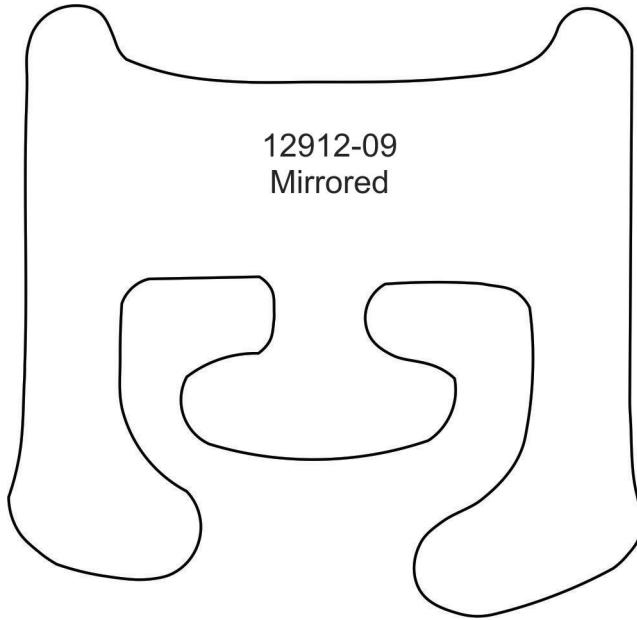

12912-09
Mirrored

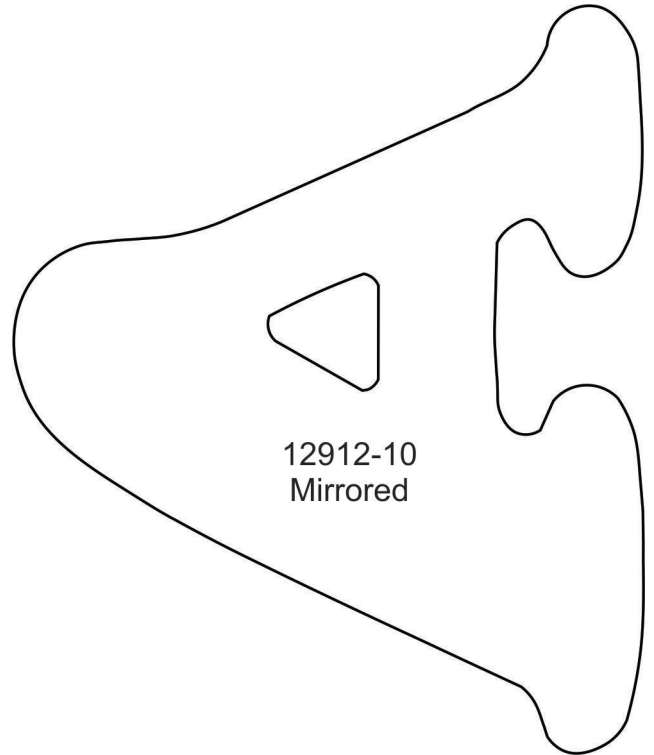

12912-10
Mirrored

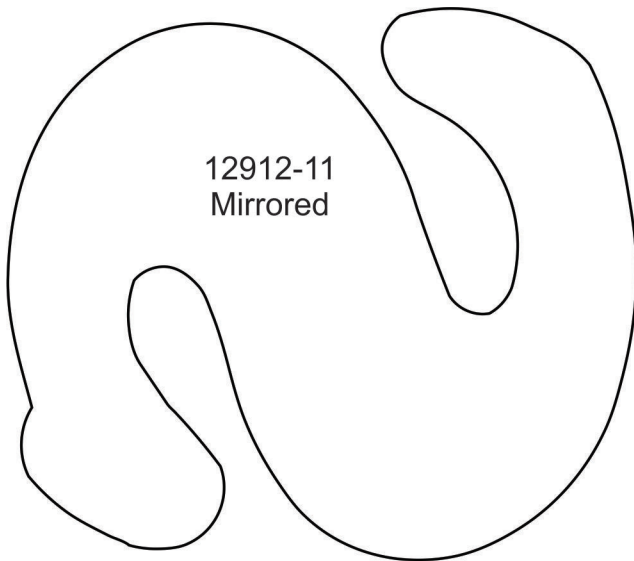

12912-11
Mirrored

MIRRORED PATTERNS



Print at 100%. No scaling. This box measures 1" x 1". Use the box as an accuracy guide when printing templates.

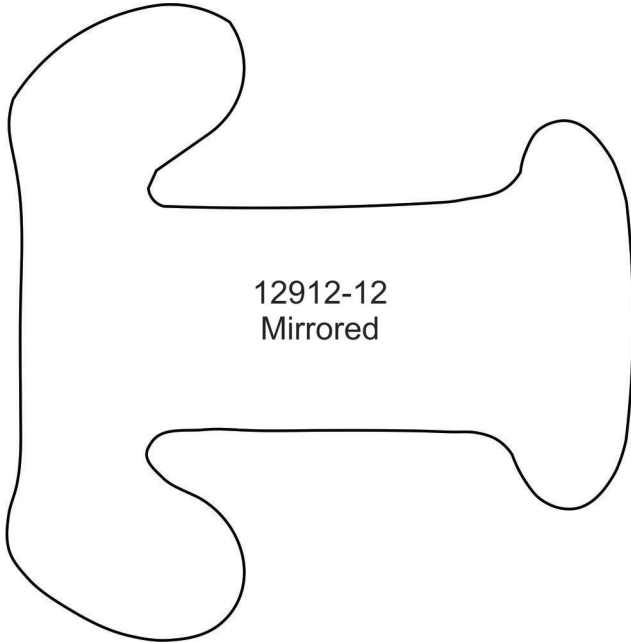

12912-12
Mirrored

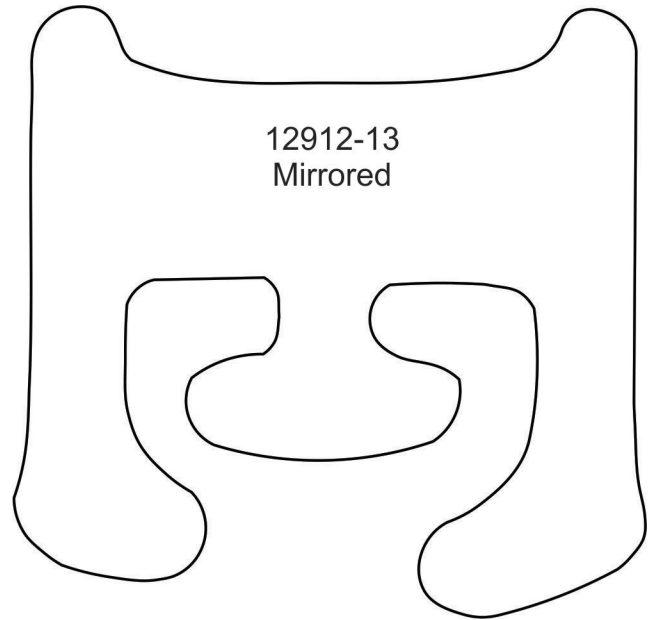

12912-13
Mirrored



12912-14
Mirrored