

WHIMSICAL BORDERS

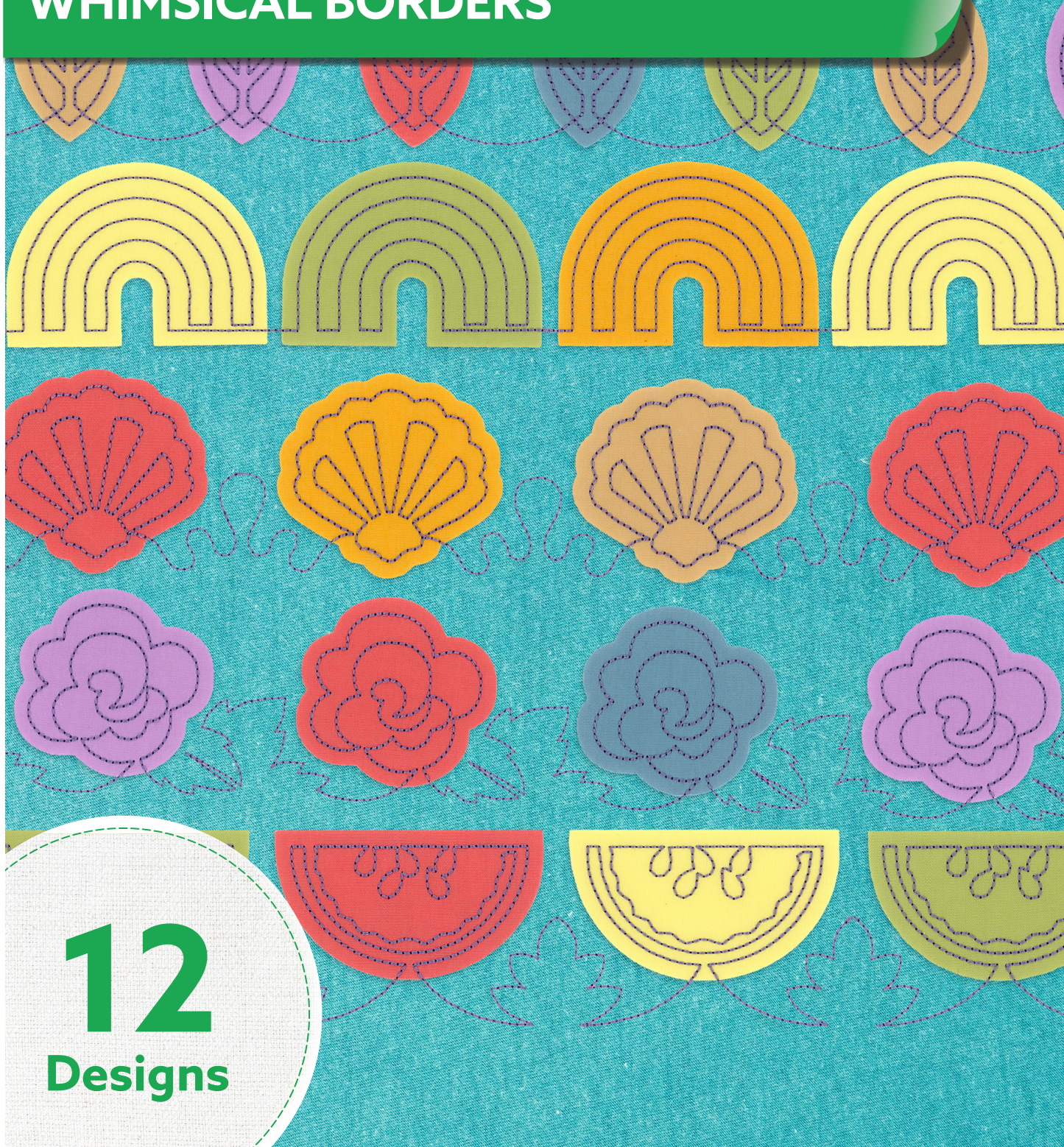

12
Designs

THREAD LIST



Isacord Thread Colors

- 0020 Black
- 3241 Amethyst Frost

*** Project instructions included after design list.**

Note: One spool of 1000 meter thread is adequate for the project unless otherwise noted.

TABLE OF CONTENTS

Designs.....	3
Collection Supplies.....	9
Embroidery	10
Applique Patterns.....	14
Mirrored Patterns.....	19

Note: Some designs in this collection may have been created using unique special stitches and/or techniques. To preserve design integrity when rescaling or rotating designs in your software, always rescale or rotate designs using the handles directly on-screen.

*Fabric Required

12925-01 Flower Applique Border

Size Inches:	Size mm:	Stitch Count:
9.01 X 1.94 in.	229.0 X 49.2 mm	2308 St.

- 1. Fabric Placement Stitch Match Fabric..... 0020
- 2. Linework/Tackdown..... 3241

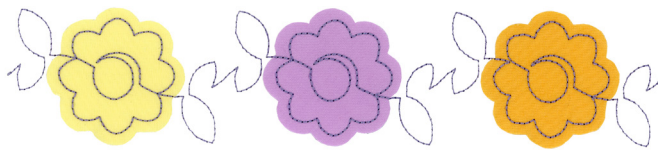

*Fabric Required

12925-02 Mushroom Applique Border

Size Inches:	Size mm:	Stitch Count:
9.00 X 1.95 in.	228.6 X 49.6 mm	2284 St.

- 1. Fabric Placement Stitch Match Fabric..... 0020
- 2. Linework/Tackdown..... 3241

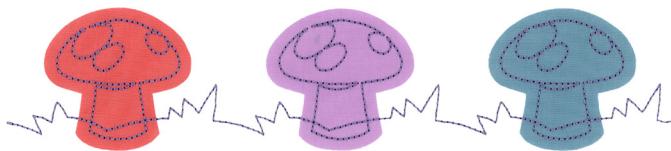

Note: Some designs in this collection may have been created using unique special stitches and/or techniques. To preserve design integrity when rescaling or rotating designs in your software, always rescale or rotate designs using the handles directly on-screen.

***Fabric Required**

12925-03 Leaf Applique Border

Size Inches:	Size mm:	Stitch Count:
9.00 X 2.05 in.	228.6 X 52.1 mm	2835 St.

- 1. Fabric Placement Stitch Match Fabric..... 0020
- 2. Linework/Tackdown 3241

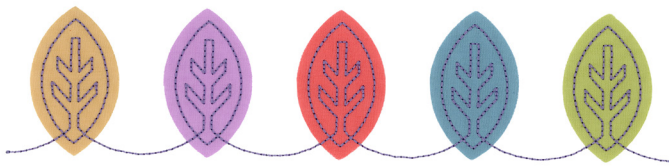

***Fabric Required**

12925-04 Rose Applique Border

Size Inches:	Size mm:	Stitch Count:
9.25 X 2.24 in.	235.0 X 56.9 mm	2984 St.

- 1. Fabric Placement Stitch Match Fabric..... 0020
- 2. Linework/Tackdown 3241

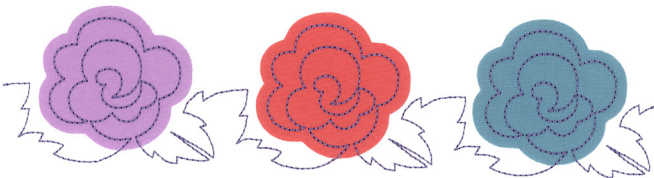

Note: Some designs in this collection may have been created using unique special stitches and/or techniques. To preserve design integrity when rescaling or rotating designs in your software, always rescale or rotate designs using the handles directly on-screen.

***Fabric Required**

12925-05 Watermelon Applique Border

Size Inches: Size mm: Stitch Count:
9.00 X 1.99 in. 228.6 X 50.7 mm 3270 St.

- 1. Fabric Placement Stitch Match Fabric..... 0020
- 2. Linework/Tackdown..... 3241

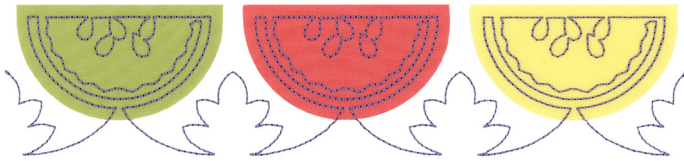

***Fabric Required**

12925-06 Rainbow Applique Border

Size Inches: Size mm: Stitch Count:
9.03 X 2.03 in. 229.4 X 51.6 mm 2803 St.

- 1. Fabric Placement Stitch Match Fabric..... 0020
- 2. Linework/Tackdown..... 3241

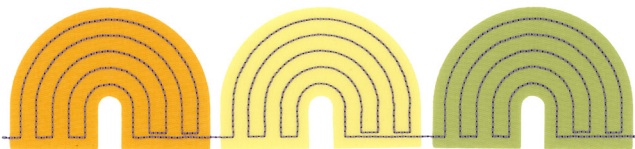

Note: Some designs in this collection may have been created using unique special stitches and/or techniques. To preserve design integrity when rescaling or rotating designs in your software, always rescale or rotate designs using the handles directly on-screen.

***Fabric Required**

12925-07 Seashell Applique Border

Size Inches:	Size mm:	Stitch Count:
9.01 X 2.10 in.	228.8 X 53.4 mm	2899 St.

- 1. Fabric Placement Stitch Match Fabric..... 0020
- 2. Linework/Tackdown..... 3241

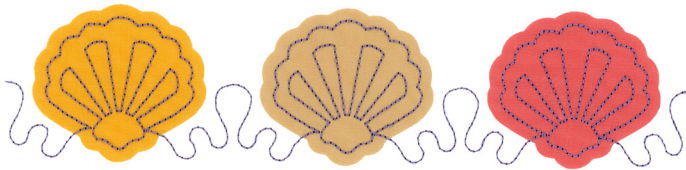

***Fabric Required**

12925-08 Diamond Applique Border

Size Inches:	Size mm:	Stitch Count:
9.01 X 2.13 in.	228.8 X 54.2 mm	2683 St.

- 1. Fabric Placement Stitch Match Fabric..... 0020
- 2. Linework/Tackdown..... 3241

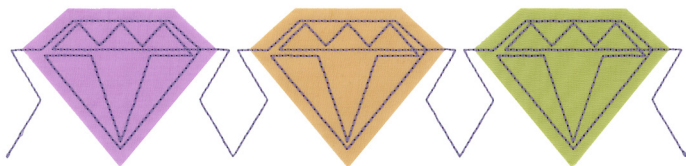

Note: Some designs in this collection may have been created using unique special stitches and/or techniques. To preserve design integrity when rescaling or rotating designs in your software, always rescale or rotate designs using the handles directly on-screen.

***Fabric Required**

12925-09 Ice Cream Applique Border

Size Inches: Size mm: Stitch Count:
9.00 X 2.42 in. 228.6 X 61.4 mm 2288 St.

- 1. Fabric Placement Stitch Match Fabric..... 0020
- 2. Linework/Tackdown 3241

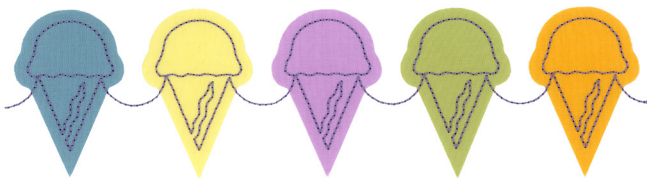

***Fabric Required**

12925-10 Thread Applique Border

Size Inches: Size mm: Stitch Count:
9.00 X 1.91 in. 228.6 X 48.5 mm 3474 St.

- 1. Fabric Placement Stitch Match Fabric..... 0020
- 2. Linework/Tackdown 3241

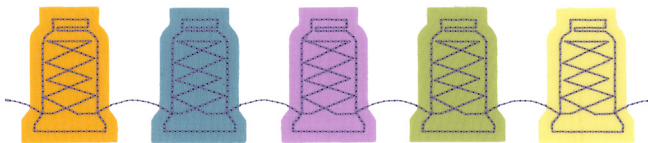

Note: Some designs in this collection may have been created using unique special stitches and/or techniques. To preserve design integrity when rescaling or rotating designs in your software, always rescale or rotate designs using the handles directly on-screen.

***Fabric Required**

12925-11 Cowboy Boot Applique Border

Size Inches: Size mm: Stitch Count:
9.00 X 2.36 in. 228.7 X 60.0 mm 3114 St.

- 1. Fabric Placement Stitch Match Fabric..... 0020
- 2. Linework/Tackdown..... 3241

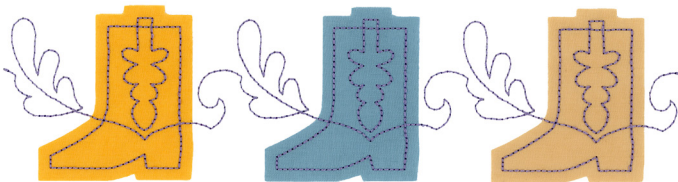

***Fabric Required**

12925-12 House Applique Border

Size Inches: Size mm: Stitch Count:
8.99 X 2.01 in. 228.5 X 50.9 mm 1777 St.

- 1. Fabric Placement Stitch Match Fabric..... 0020
- 2. Linework/Tackdown..... 3241



COLLECTION SUPPLIES



Stabilizers

- OESD Applique Fuse and Fix
- OESD Ultra Clean and Tear

Fabrics/Textiles

- Assorted colors cotton fabric 3" squares
- White quilter's cotton
- Note: Fabric sizes are estimates and may result in overage.

Notions & Tools

- OESD Perfect Embroidery Press Cloth
- Embroidery Needle Sharp 75/11

Isacord Thread Colors

- Per thread chart
- Note:** The applique instructions, included in the collection, are general instructions. For demonstration purposes, a sample design that best demonstrates the technique is shown. Fabric and thread requirements will vary by design, but the general technique is the same.

STEP 1

- Print the mirrored version of the templates (at 100% scale or 1:1 ratio) onto the paper side of of Applique Fuse and Fix.

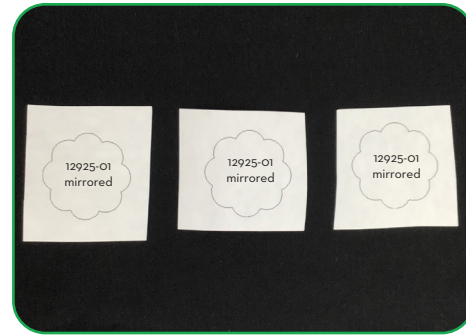
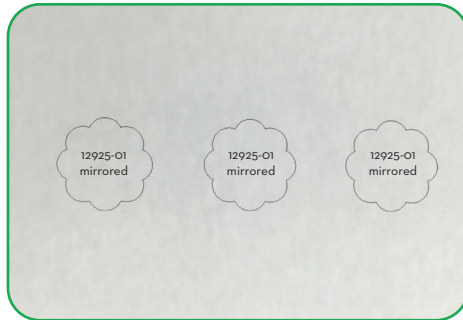

STEP 2

- Cut the prepared applique fabrics 1/4"-1/2" larger than the applique templates.
- Fuse the trimmed templates to the wrong side of the applique fabric with the paper side of the printed template up.



STEP 3

- Trim the prepared appliques on the outer edge of the black outline. Set aside.



STEP 4

- Hoop the desired stabilizer and fabric for the project.
- In the example, we used Ultra Clean and Tear stabilizer and white quilter's cotton fabric.

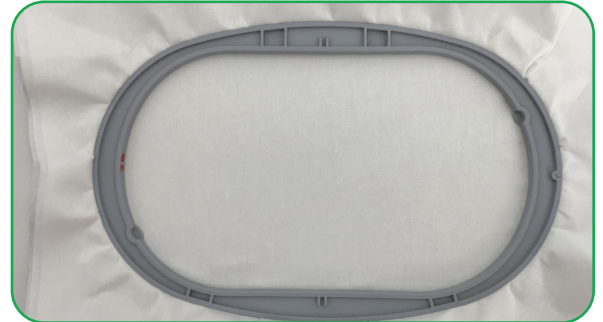

STEP 5

- Load selected design into the machine.
 - Example design is 12925-01.
 - Thread the machine per the thread chart.
 - Place the hoop on the machine.
 - Stitch Machine Step 1, Fabric Placement Stitch/Match Fabric.
- Note: Some thread colors in instructions have been changed or digitally enhanced for better visibility.

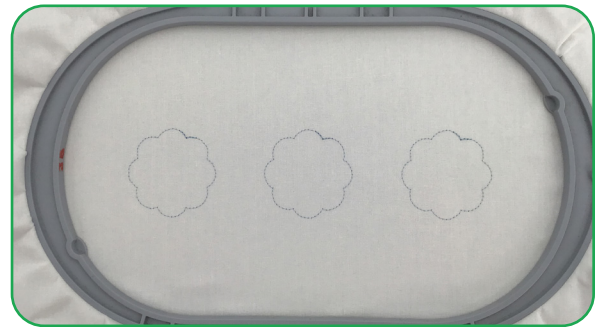

STEP 6

- Remove the hoop from the machine, but NOT the project from the hoop.
- Place the hoop on a flat surface.
- On the back of the prepared applique fabric, score and remove the paper backing to reveal the adhesive surface.
- Place the applique within the placement stitching.
- Finger press to secure.
- Return the hoop to the machine.
- Tip: Applique Fuse and Fix is repositionable.

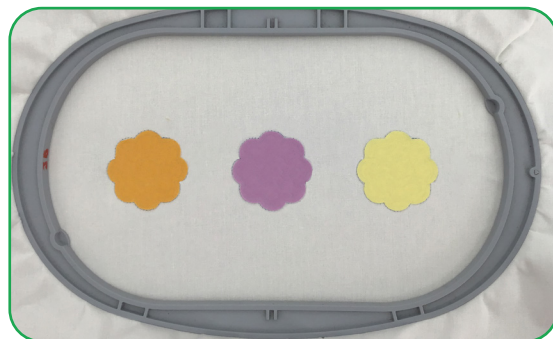

STEP 7

- Stitch Machine Step 2, Linework/Tackdown.

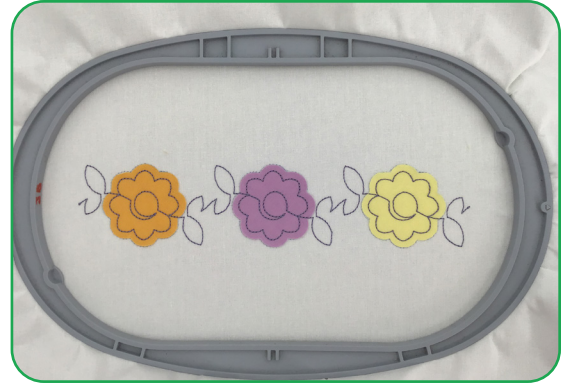

STEP 8

- When the design is complete, remove the hoop from the machine AND remove the project from the hoop.
- Rehoop fabric and stabilizer.
- Use machine placement features to align the design to connect with the previous stitchout.
- Continue the length of the project as desired.
- The project is complete. Enjoy!



ATTENTION

When printing this document, any page scaling or page fitting options in your print dialog box must be turned OFF or set to NONE so that your files will print out at their actual size. Images not printed at actual size will not function as intended.

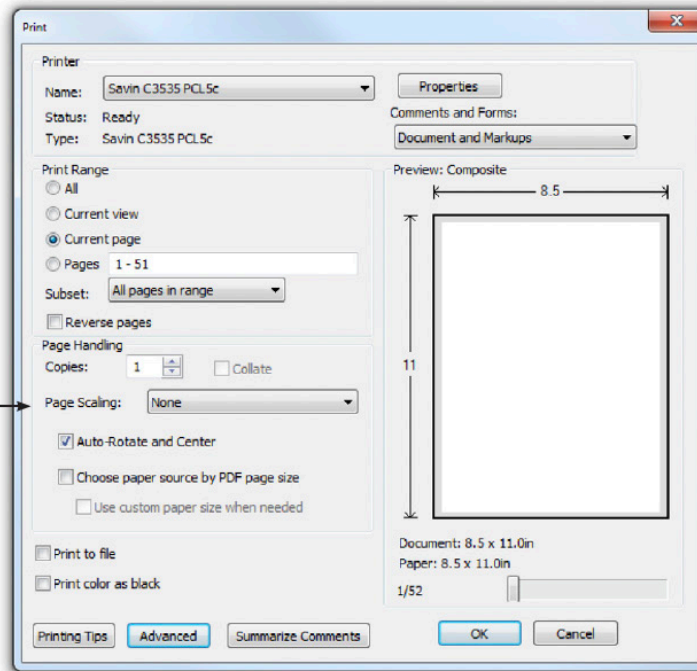

TO SAVE PAPER

Only print the desired image by navigating to the image's page, go to File > Print and select "Current page" in the print dialog box. Repeat for each desired image.

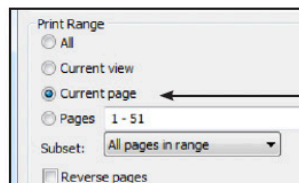

APPLIQUE PATTERNS



Print at 100%. No scaling. This box measures 1" x 1". Use the box as an accuracy guide when printing templates.

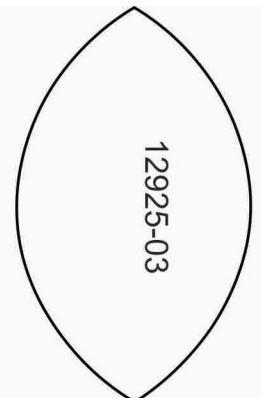
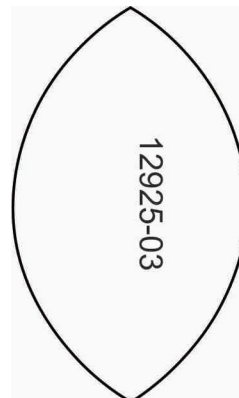
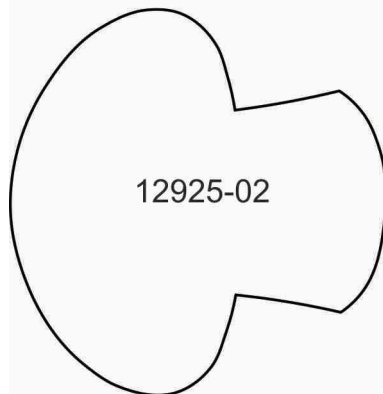
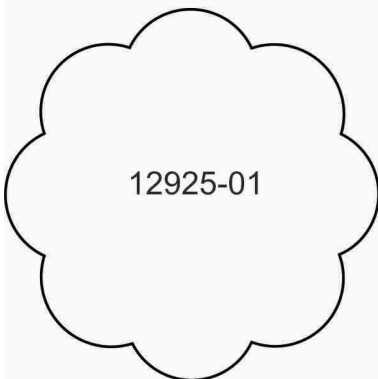
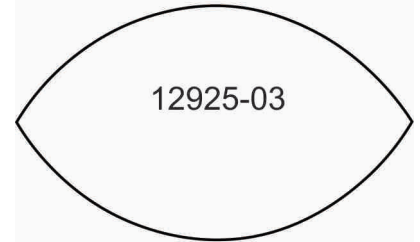
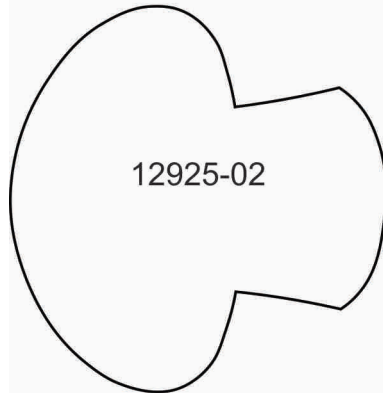
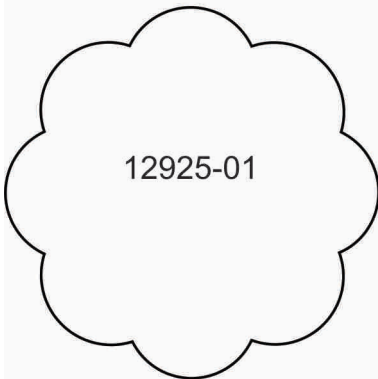
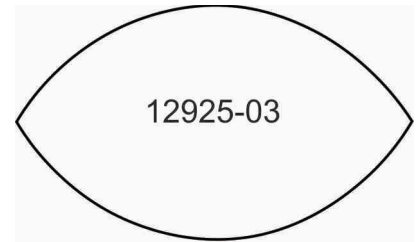
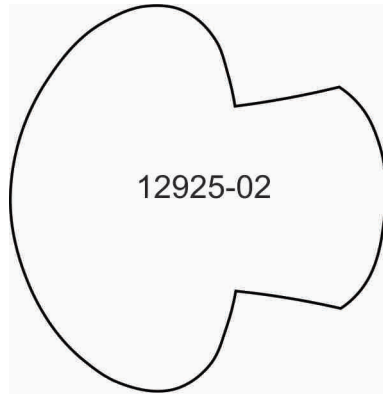
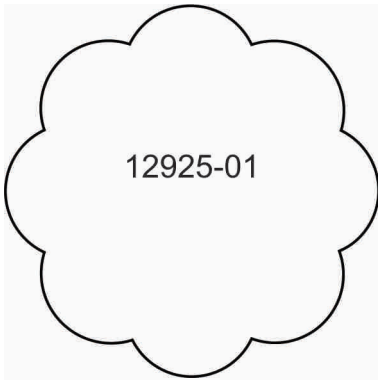

APPLIQUE PATTERNS



Print at 100%. No scaling. This box measures 1" x 1". Use the box as an accuracy guide when printing templates.

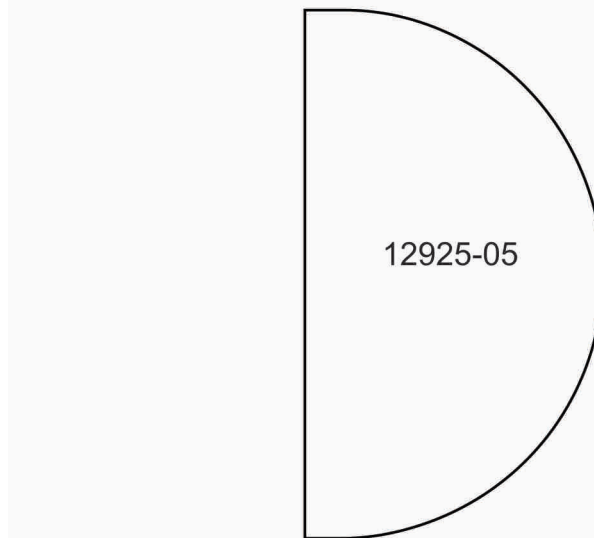
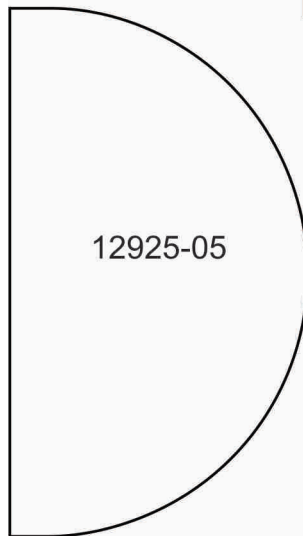
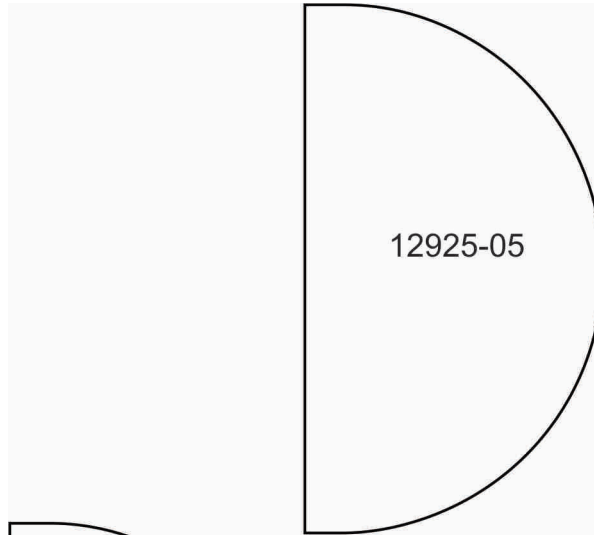
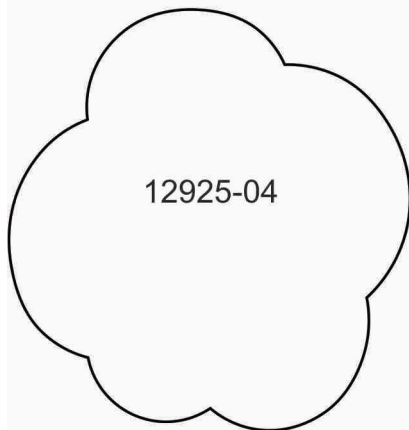
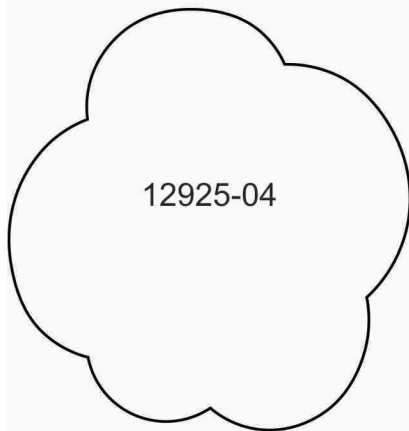
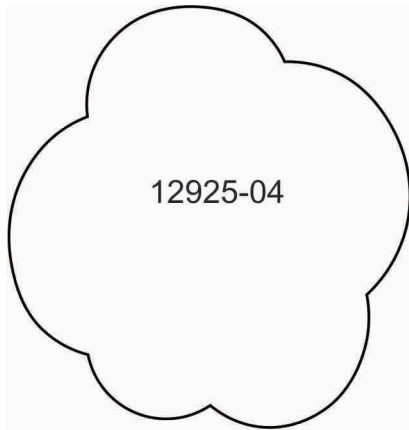

APPLIQUE PATTERNS



Print at 100%. No scaling. This box measures 1" x 1". Use the box as an accuracy guide when printing templates.

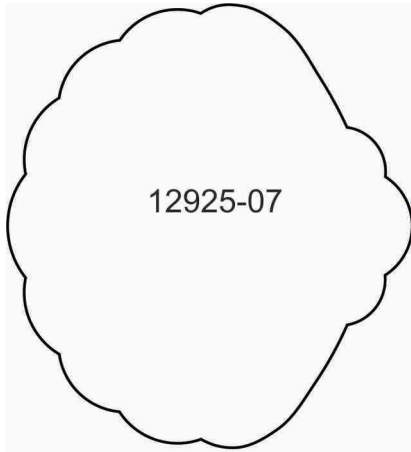

12925-07

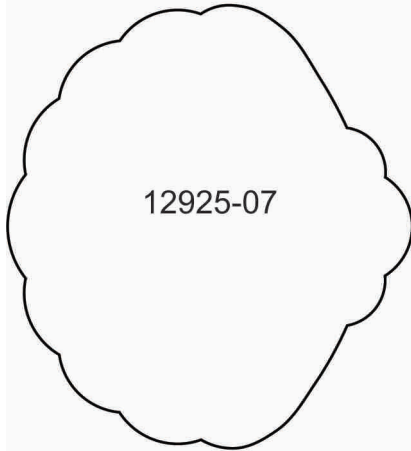

12925-07

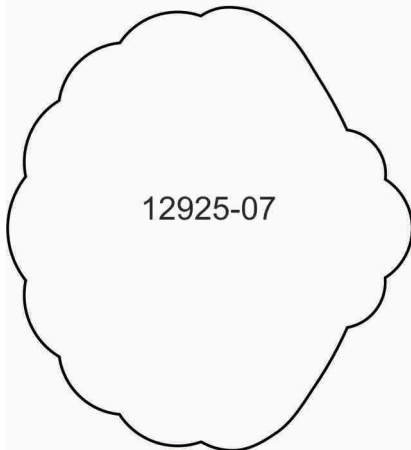

12925-07

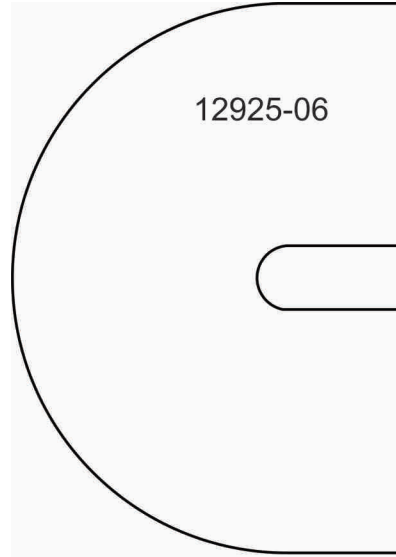

12925-06

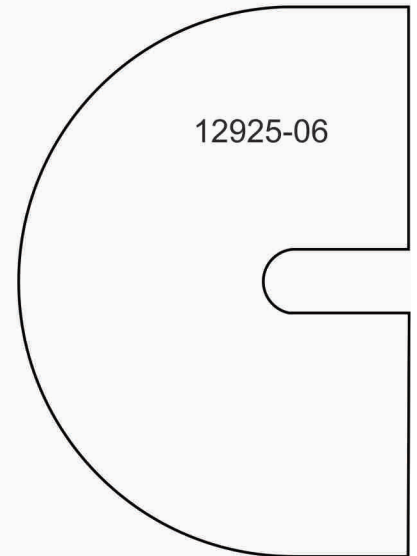

12925-06

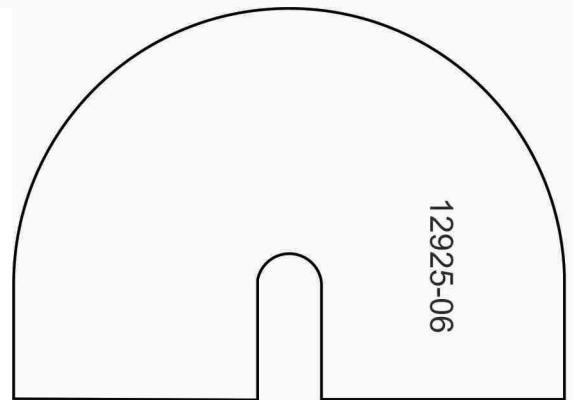

12925-06

APPLIQUE PATTERNS



Print at 100%. No scaling. This box measures 1" x 1". Use the box as an accuracy guide when printing templates.

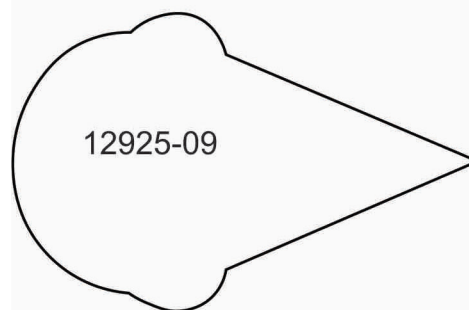
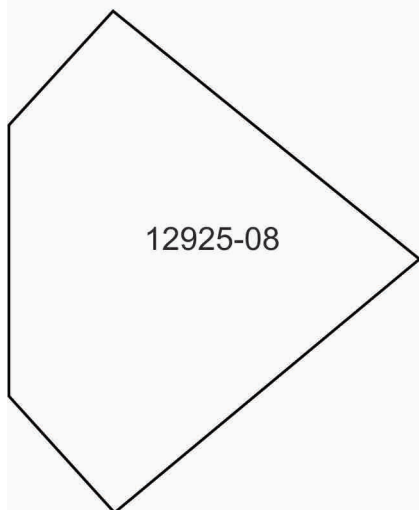
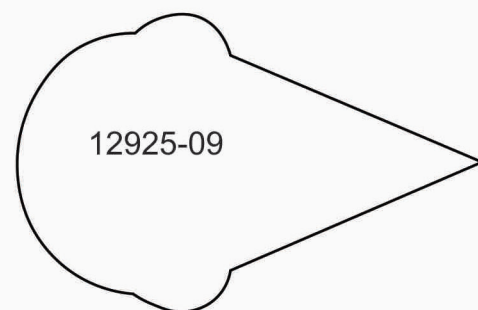
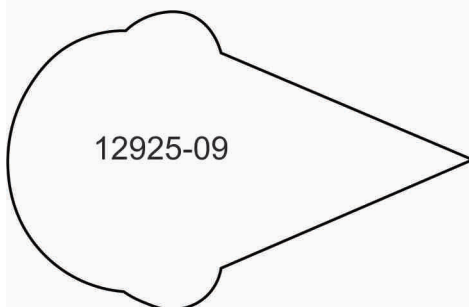
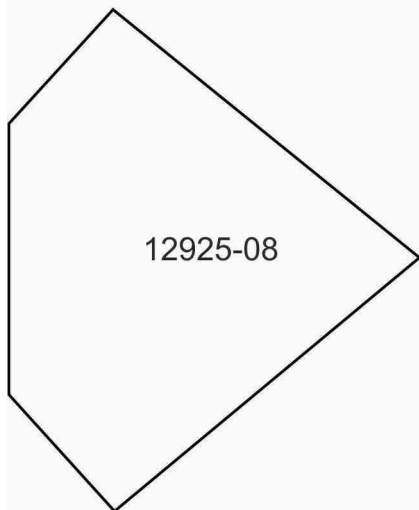
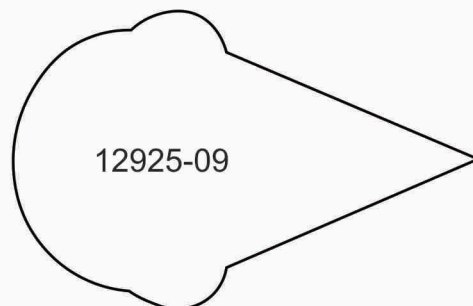
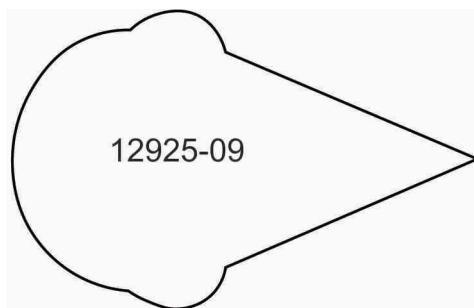
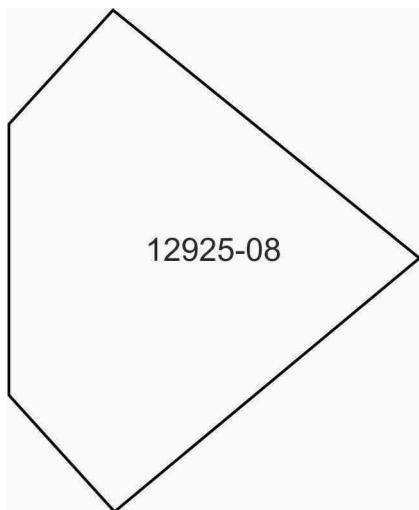

APPLIQUE PATTERNS



Print at 100%. No scaling. This box measures 1" x 1". Use the box as an accuracy guide when printing templates.

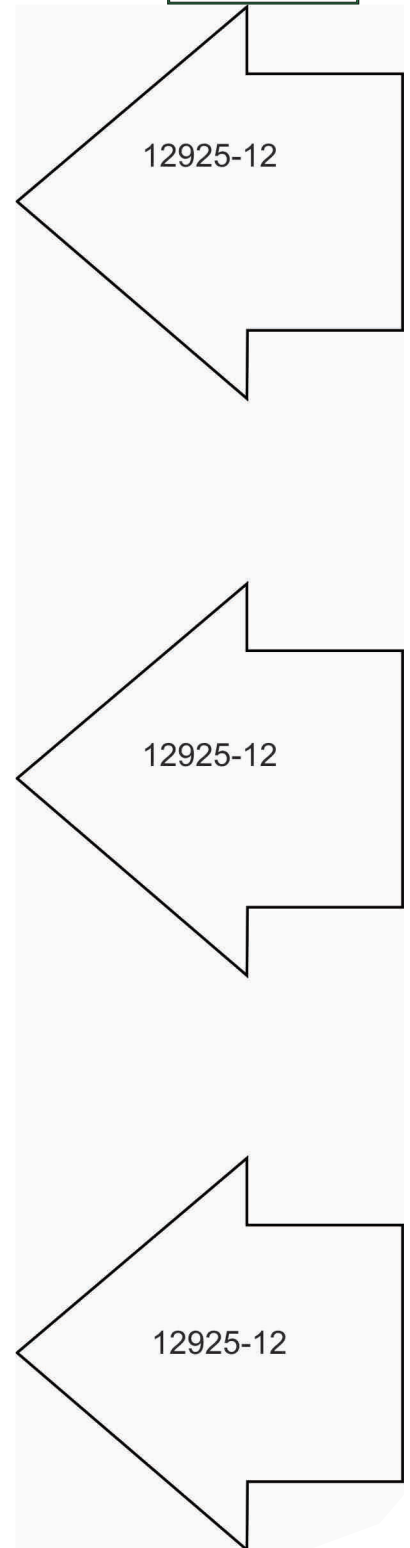
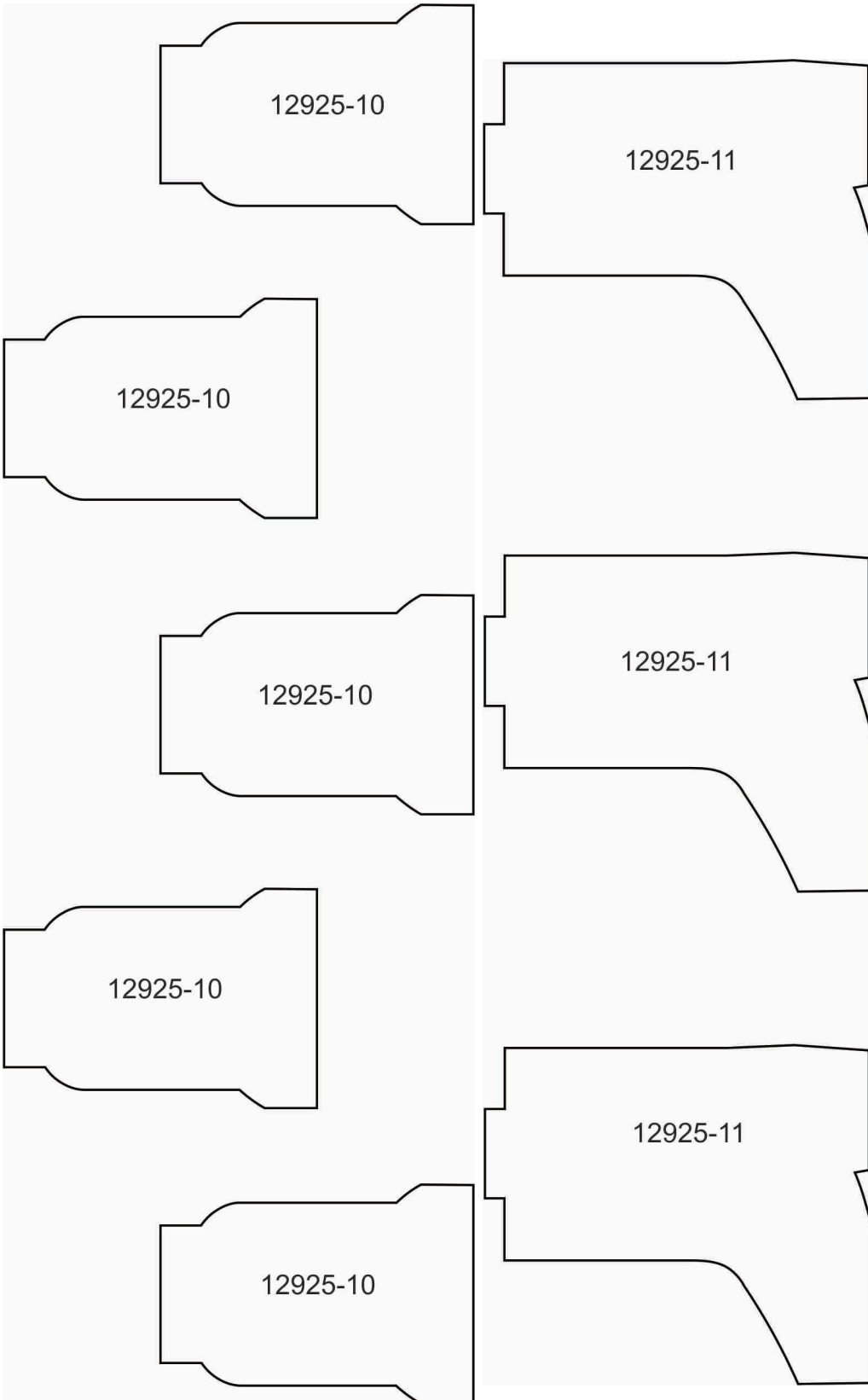

MIRRORED PATTERNS



Print at 100%. No scaling. This box measures 1" x 1". Use the box as an accuracy guide when printing templates.

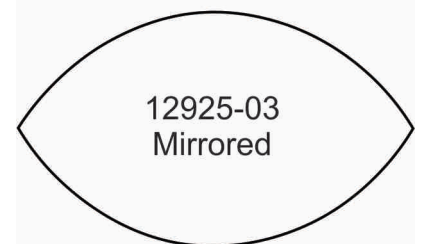
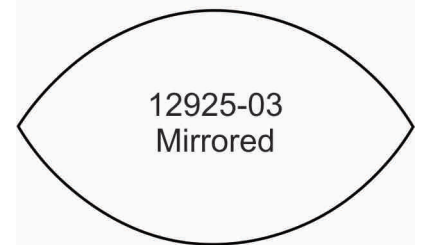
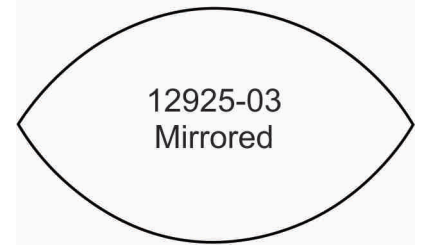
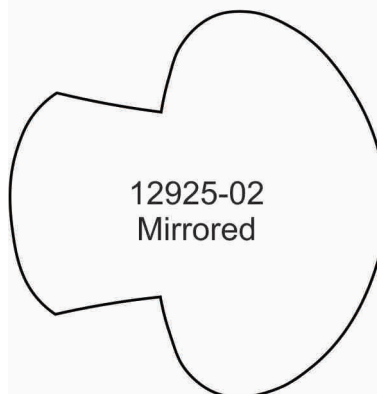
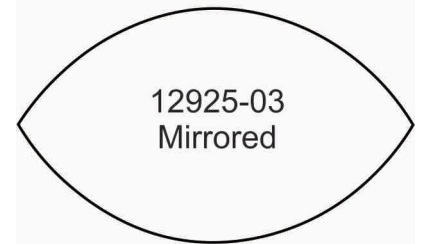
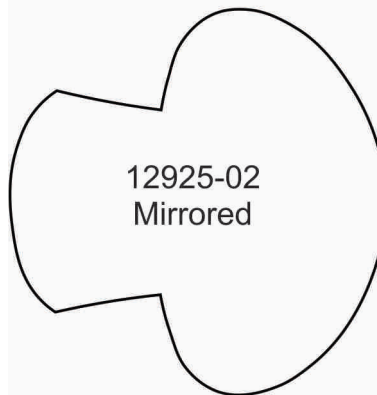
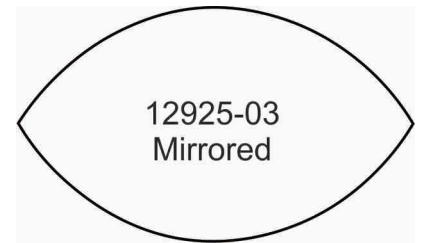
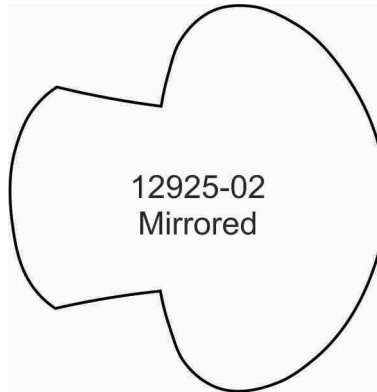
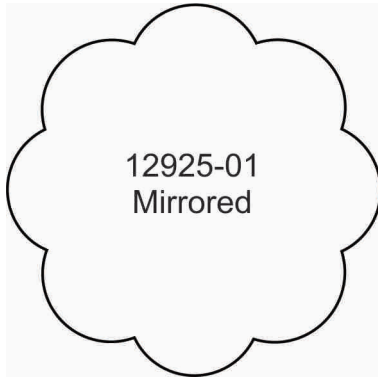

MIRRORED PATTERNS



Print at 100%. No scaling. This box measures 1" x 1". Use the box as an accuracy guide when printing templates.

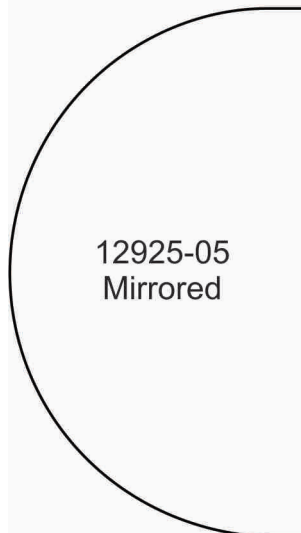
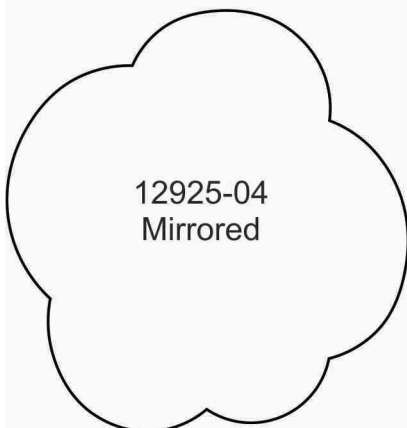
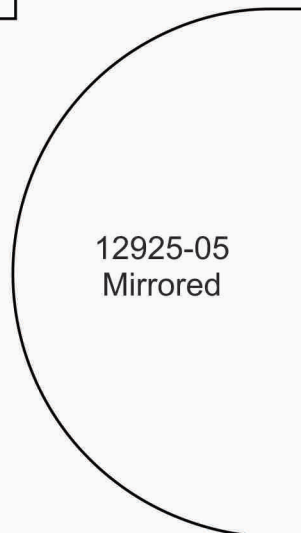
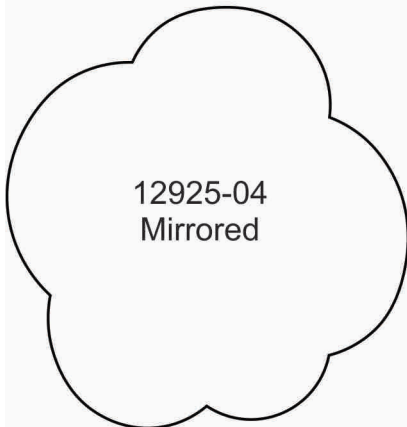
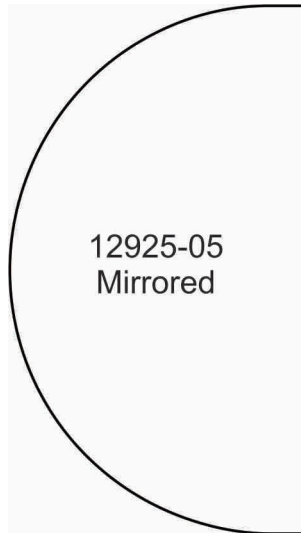

MIRRORED PATTERNS

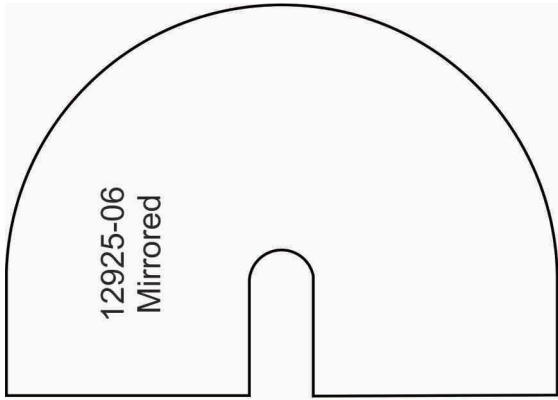

12925-06
Mirrored



12925-07
Mirrored

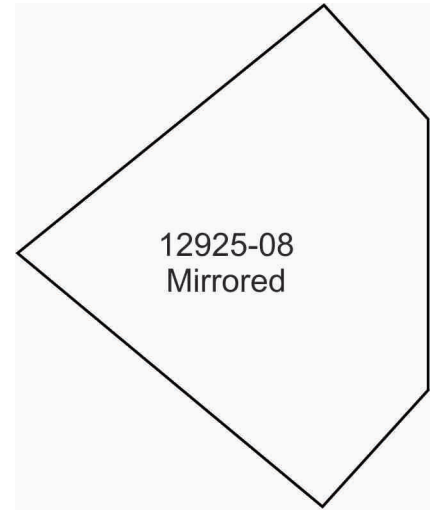

12925-08
Mirrored

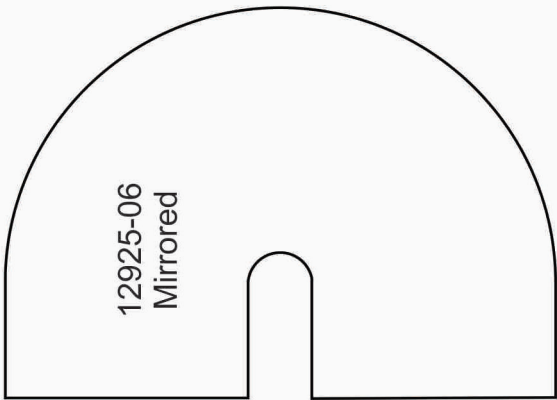

12925-06
Mirrored

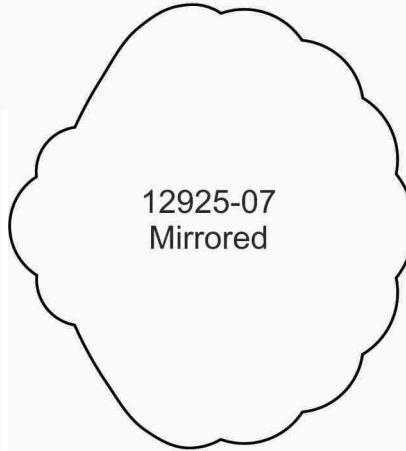

12925-07
Mirrored

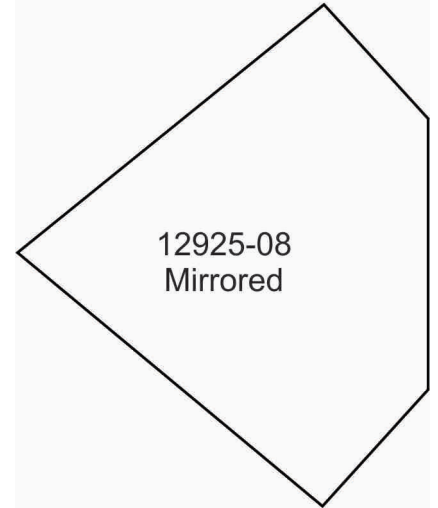

12925-08
Mirrored

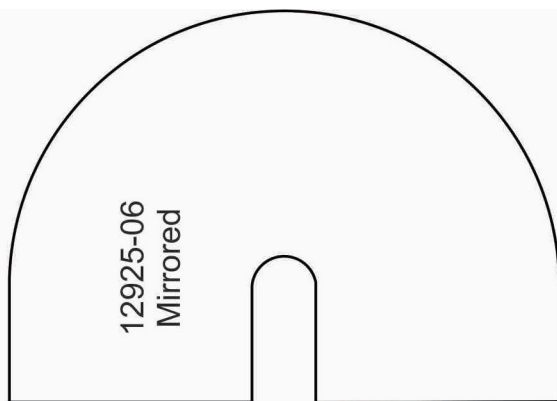

12925-06
Mirrored



12925-07
Mirrored

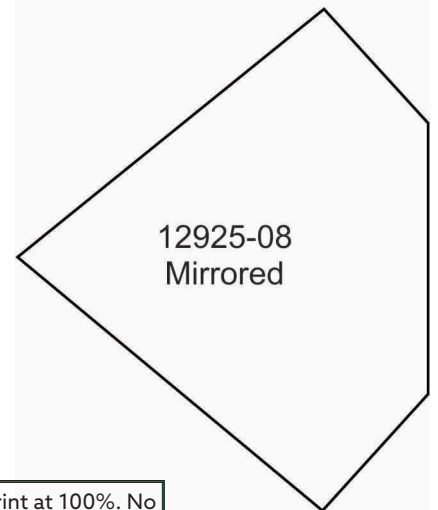

12925-08
Mirrored

Print at 100%. No scaling. This box measures 1" x 1". Use the box as an accuracy guide when printing templates.

MIRRORED PATTERNS

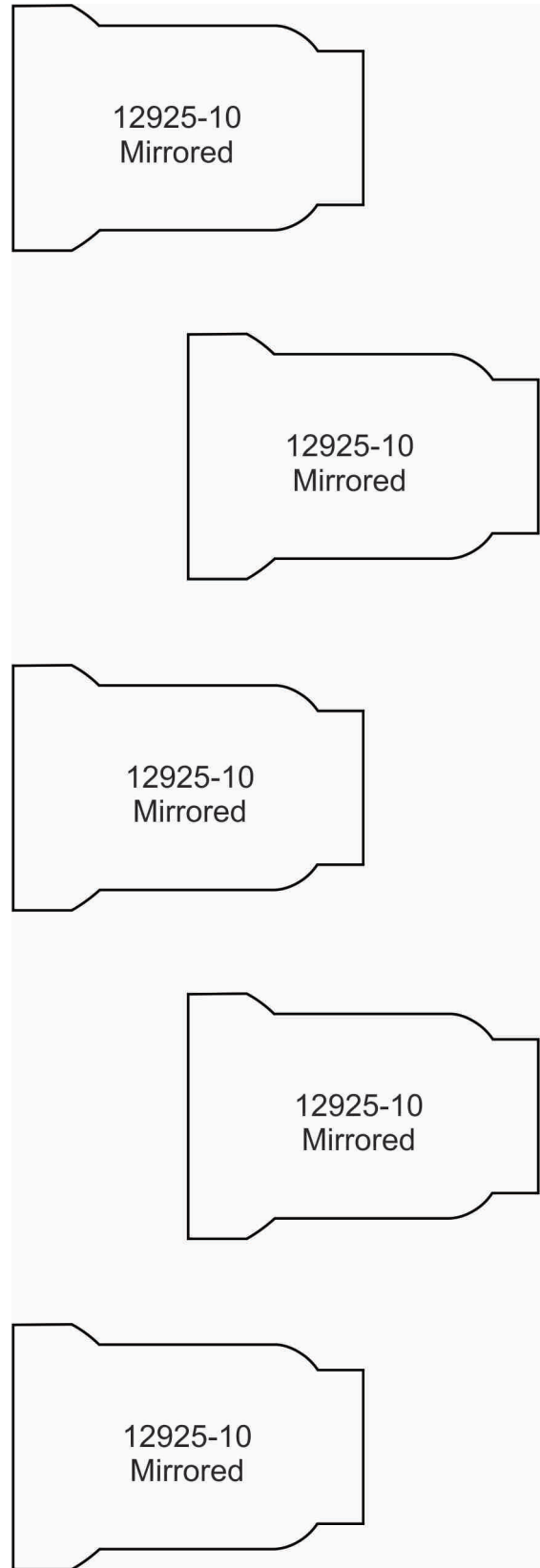
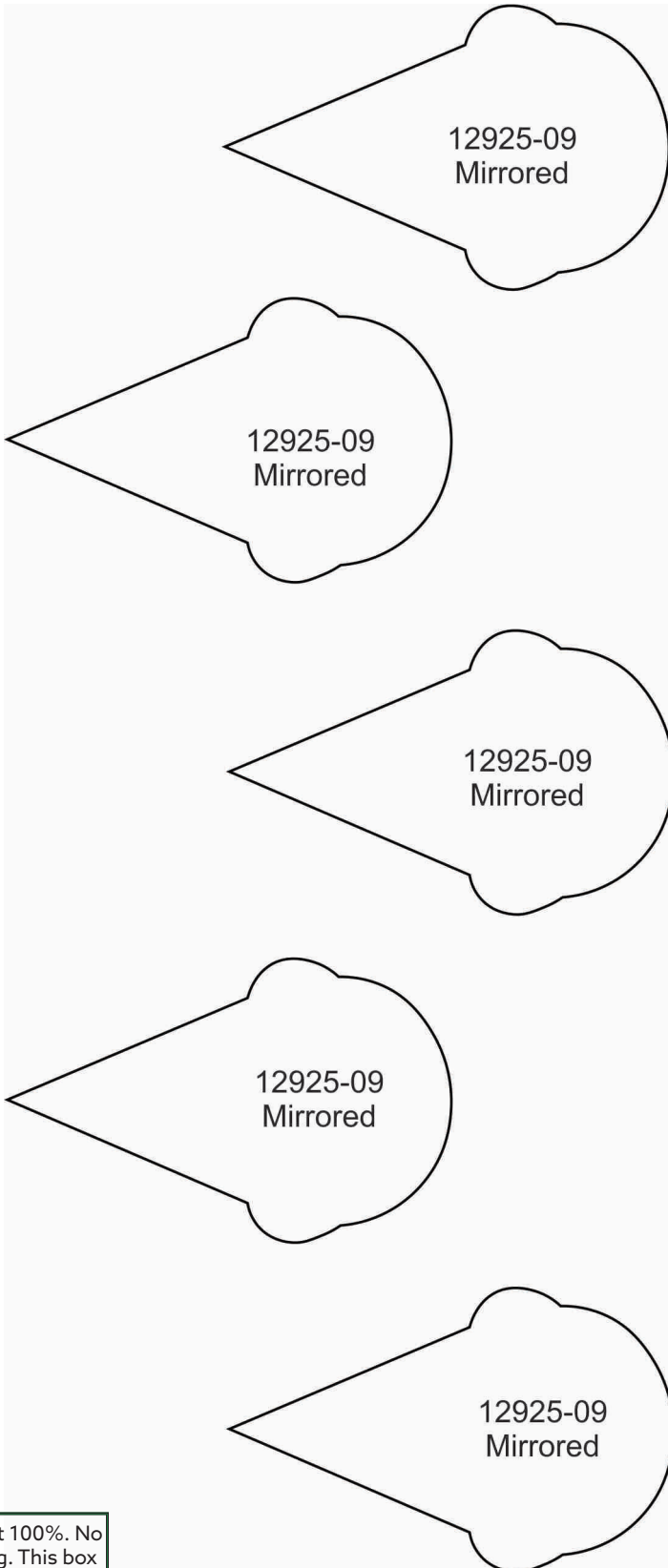

Print at 100%. No scaling. This box measures 1" x 1". Use the box as an accuracy guide when printing templates.

MIRRORED PATTERNS



Print at 100%. No scaling. This box measures 1" x 1". Use the box as an accuracy guide when printing templates.

