

ADORABLE APPLIQUE CHRISTMAS



10
Designs

Isacord Thread Colors

0010 Silky White	1154 Penny
0020 Black	1903 Lipstick
0131 Smoke	2051 Teaberry
0184 Pearl	2152 Heather Pink
0520 Daffodil	3732 Slate Blue
0622 Star Gold	3840 Oxford
0821 Honey Gold	4073 Metal
0853 Pecan	5510 Emerald
1055 Bark	5822 Kiwi
1114 Clay	

*** General project instructions included after the design list.**

Note: One spool of 1000 meter thread is adequate for the project unless otherwise noted.

TABLE OF CONTENTS

Designs.....	3
Collection Supplies.....	8
Embroidery	9
Applique Patterns.....	16
Mirrored Patterns.....	21

Note: Some designs in this collection may have been created using unique special stitches and/or techniques. To preserve design integrity when rescaling or rotating designs in your software, always rescale or rotate designs using the handles directly on-screen.

***Fabric Required**



12935-01 Holiday Penguin Applique

Size Inches: 5.33 X 5.09 in. Size mm: 135.5 X 129.2 mm Stitch Count: 13929 St.

1.	Black Fabric Placement Stitch.....	0184
2.	Cut Line and Tackdown	0184
3.	White Fabric Placement Stitch	0184
4.	Cut Line and Tackdown	0184
5.	Green Fabric Placement Stitch	0184
6.	Cut Line and Tackdown	0184
7.	Gray Cover Stitch	0184
8.	Yellow Detail	0520
9.	Black Cover Stitch	0020
10.	Green Cover Stitch	5510
11.	Red Detail.....	1903
12.	Green Detail	5510
13.	White Detail	0010

***Fabric Required**



12935-02 I'm Snow Cute Applique

Size Inches: 5.49 X 5.54 in. Size mm: 139.6 X 140.7 mm Stitch Count: 13687 St.

1.	White Fabric Placement Stitch	3840
2.	Cut Line and Tackdown	3840
3.	Light Blue Cover Stitch.....	3840
4.	Light Blue Detail	3840
5.	Orange Detail	1114
6.	Dark Blue Detail	3732
7.	Dark Blue Lettering.....	3732









Note: Some designs in this collection may have been created using unique special stitches and/or techniques. To preserve design integrity when rescaling or rotating designs in your software, always rescale or rotate designs using the handles directly on-screen.

***Fabric Required**



12935-03 Gingerbread Man Applique

Size Inches: Size mm: Stitch Count:
 5.49 X 5.53 in. 139.5 X 140.4 mm 10826 St.







	1. Brown Fabric Placement Stitch	1154
	2. Cut Line and Tackdown	1154
	3. Red Fabric Placement Stitch	1154
	4. Cut Line and Tackdown	1154
	5. Brown Cover Stitch	1154
	6. Red Cover Stitch	1903
	7. Green Detail	5510
	8. White Detail	0010

***Fabric Required**



12935-04 Merry Little Christmas Applique

Size Inches: Size mm: Stitch Count:
 4.66 X 4.56 in. 118.5 X 115.7 mm 10873 St.

	1. Red Fabric Placement Stitch	1903
	2. Cut Line and Tackdown	1903
	3. White Fabric Placement Stitch	1903
	4. Cut Line and Tackdown	1903
	5. Red Cover Stitch	1903
	6. Gray Cover Stitch	0184
	7. Green Detail	5822

Note: Some designs in this collection may have been created using unique special stitches and/or techniques. To preserve design integrity when rescaling or rotating designs in your software, always rescale or rotate designs using the handles directly on-screen.

***Fabric Required**



12935-05 Holiday Hippo Applique

Size Inches: 5.49 X 4.83 in. Size mm: 139.6 X 122.7 mm Stitch Count: 14511 St.

■	1. Gray Fabric Placement Stitch.....	4073
■	2. Cut Line and Tackdown	4073
■	3. Pink Fabric Placement Stitch	4073
■	4. Cut Line and Tackdown	4073
■	5. Dark Gray Cover Stitch	4073
■	6. Dark Pink Cover Stitch	2051
■	7. Black Detail	0020
■	8. Pink Detail	2152
■	9. Red Detail.....	1903
□	10. White Detail	0010
■	11. Light Green Detail	5822
■	12. Green Detail	5510
■	13. Light Gray Cover Stitch	0184

***Fabric Required**



12935-06 Merry Christmas Applique

Size Inches: 5.47 X 5.48 in. Size mm: 139.1 X 139.3 mm Stitch Count: 16342 St.

■	1. Green Fabric Placement Stitch	5510
■	2. Cut Line and Tackdown	5510
■	3. Red Fabric Placement Stitch.....	5510
■	4. Cut Line and Tackdown	5510
■	5. Green Cover Stitch.....	5510
■	6. Red Cover Stitch	1903
■	7. Black Detail	0020
□	8. White Detail	0010
■	9. Gray Detail	0131
■	10. Yellow Detail.....	0821

Note: Some designs in this collection may have been created using unique special stitches and/or techniques. To preserve design integrity when rescaling or rotating designs in your software, always rescale or rotate designs using the handles directly on-screen.

***Fabric Required**



12935-07 Holiday Lion Applique

Size Inches: 5.48 X 4.90 in. Size mm: 139.2 X 124.5 mm Stitch Count: 14494 St.

■	1. Orange Fabric Placement Stitch	0622
■	2. Cut Line and Tackdown	0622
■	3. Yellow Fabric Placement Stitch	0622
■	4. Cut Line and Tackdown	0622
■	5. Yellow Cover Stitch.....	0622
■	6. Orange Cover Stitch.....	1114
■	7. Brown Detail	0853
□	8. White Detail	0010
■	9. Black Detail	0020
■	10. Green Detail	5510
■	11. Red Detail.....	1903
■	12. Gray Detail	4073

***Fabric Required**



12935-08 Snowman Applique

Size Inches: 5.50 X 4.86 in. Size mm: 139.8 X 123.5 mm Stitch Count: 7284 St.

■	1. Black Fabric Placement.....	1114
■	2. Cut Line and Tackdown	1114
■	3. Orange Fabric Placement Stitch	1114
■	4. Cut Line and Tackdown	1114
■	5. Orange Cover Stitch.....	1114
■	6. Black Cover Stitch and Detail.....	0020

Note: Some designs in this collection may have been created using unique special stitches and/or techniques. To preserve design integrity when rescaling or rotating designs in your software, always rescale or rotate designs using the handles directly on-screen.

***Fabric Required**



12935-09 My 1st Christmas Applique

Size Inches: 3.73 X 4.46 in. Size mm: 94.8 X 113.4 mm Stitch Count: 8292 St.

- 1. Green Fabric Placement Stitch 5510
- 2. Cut Line and Tackdown 5510
- 3. Brown Fabric Placement Stitch 5510
- 4. Cut Line and Tackdown 5510
- 5. Green Cover Stitch 5510
- 6. Brown Cover Stitch 1055
- 7. Red Nose Detail 1903
- 8. Black Detail 0020
- 9. Green Detail 5510
- 10. Red Lettering Detail 1903

***Fabric Required**



12935-10 Cool Santa Applique

Size Inches: 5.53 X 5.43 in. Size mm: 140.4 X 138.0 mm Stitch Count: 10576 St.

- 1. Red Fabric Placement Stitch 1903
- 2. Cut Line and Tackdown 1903
- 3. White Fabric Placement Stitch 1903
- 4. Cut Line and Tackdown 1903
- 5. Red Cover Stitch 1903
- 6. Gray Cover Stitch 0184
- 7. Black Detail 0020
- 8. White Detail 0010

COLLECTION SUPPLIES



Stabilizers

- OESD Fusible Woven
- OESD StabilStick TearAway

Fabrics/Textiles

- Assorted colors cotton fabric
- White quilter's cotton

Notions & Tools

- OESD Perfect Embroidery Press Cloth
- Embroidery Needle Sharp 75/11

Isacord Thread Colors

- Per thread chart

NOTES

- The applique instructions, included in the collection, are general instructions. For demonstration purposes, a sample design that best demonstrates the technique is shown.
- Fabric and thread requirements will vary by design, but the general technique is the same.
- The Example design is 51303-03 from Scissortail Stitches collection Adorable Autumn 51303.
- Note: Some thread colors in instructions have been changed or digitally enhanced for better visibility.

STEP 1

- Apply one layer of Fusible Woven to the wrong side of the applique fabric.



STEP 2

- Hoop the desired stabilizer.
- Example stabilizer is StabilStick TearAway.
- Place the fabric on the stabilizer.
- Finger press to adhere.

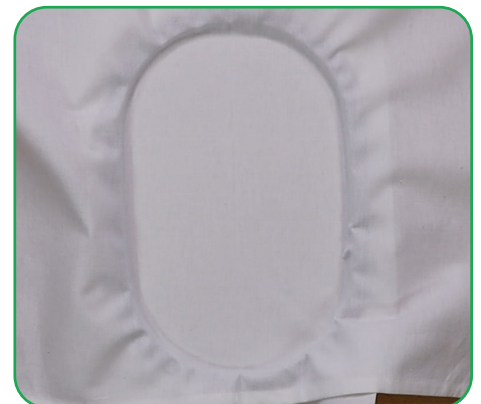

EMBROIDERY



STEP 3

- Load selected design into the machine.
- The example design is 51303-03 from Scissortail Stitches collection Adorable Autumn 51303.
- Thread the machine per the thread chart.
- Place the hoop on the machine.
- Stitch Machine Step 1, Tan Placement Stitch.



STEP 4

- Remove the hoop from the machine, but NOT the project from the hoop.
- Completely cover the placement stitch with the prepared fabric.
- Tape in place to secure.
- Return the hoop to the machine.

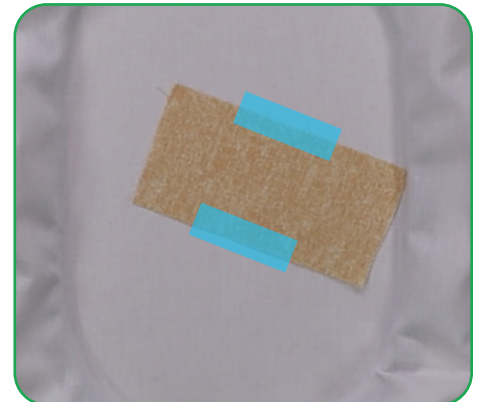

STEP 5

- Stitch Machine Step 2, Cut Line and Tackdown.

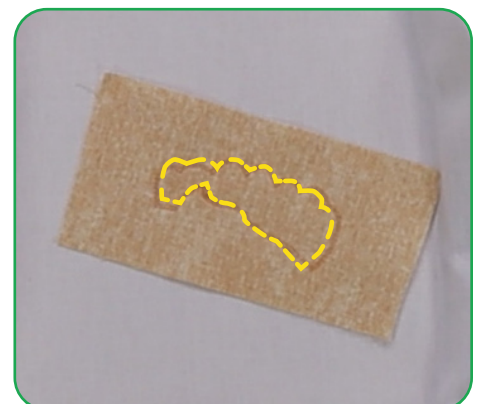

STEP 6

- Remove the hoop from the machine, but NOT the project from the hoop.
- Place on a flat surface.
- Trim the excess fabric as close to the cut line as possible.
- Note: If the outermost stitches (cut line) are cut, the inner stitches (tackdown) will hold the applique in place.



STEP 7

- Place the hoop on the machine.
- Stitch Machine Step 3, Orange Fabric Placement Stitch.



STEP 8

- Remove the hoop from the machine, but NOT the project from the hoop.
- Completely cover the placement stitch with the prepared fabric.
- Tape in place to secure.
- Return the hoop to the machine.

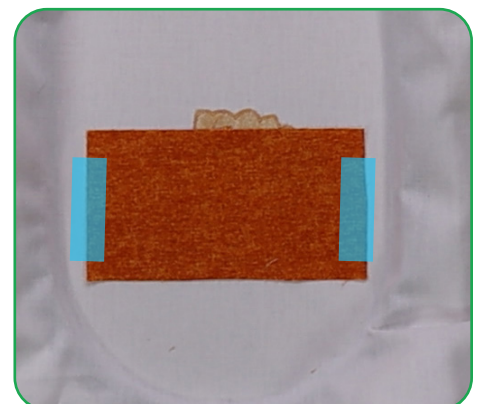

STEP 9

- Stitch Machine Step 4, Cut Line and Tackdown.



STEP 10

- Remove the hoop from the machine, but NOT the project from the hoop.
- Place on a flat surface.
- Trim the excess fabric as close to the cut line as possible.

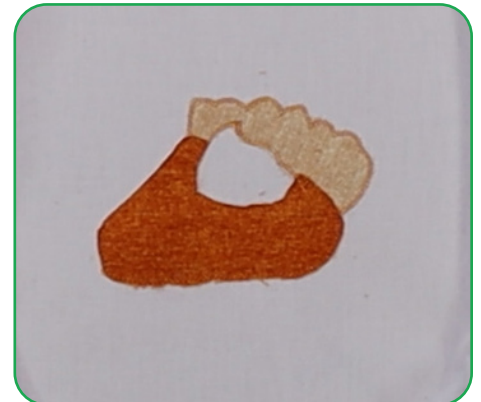

STEP 11

- Stitch Machine Step 5, White Fabric Placement Stitch.

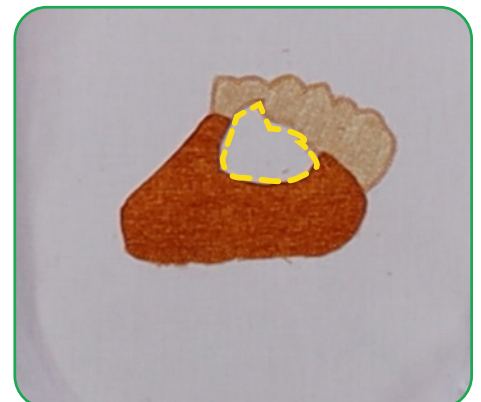

STEP 12

- Remove the hoop from the machine, but NOT the project from the hoop.
- Completely cover the placement stitch with the prepared fabric.
- Tape in place to secure.
- Return the hoop to the machine.

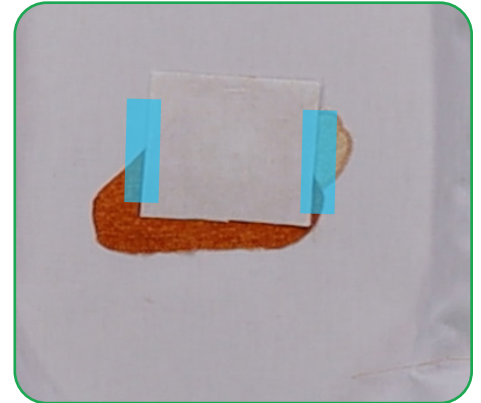

STEP 13

- Stitch Machine Step 6, Cut Line and Tackdown.
- Remove the hoop from the machine, but NOT the project from the hoop.
- Place on a flat surface.
- Trim the excess fabric as close to the cut line as possible.

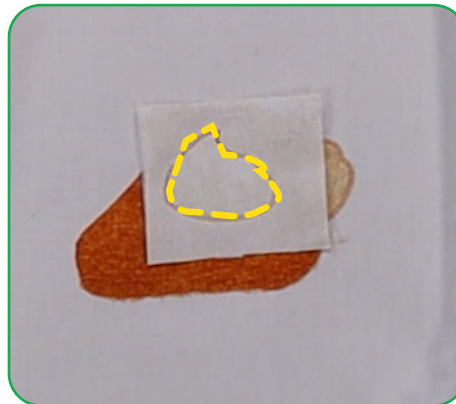

STEP 14

- Return the hoop to the machine and stitch the remaining steps per the thread chart.



STEP 15

- When the design is complete, remove excess stabilizer.
- Press right side down on a Perfect Embroidery Press Cloth.



ATTENTION

When printing this document, any page scaling or page fitting options in your print dialog box must be turned OFF or set to NONE so that your files will print out at their actual size. Images not printed at actual size will not function as intended.

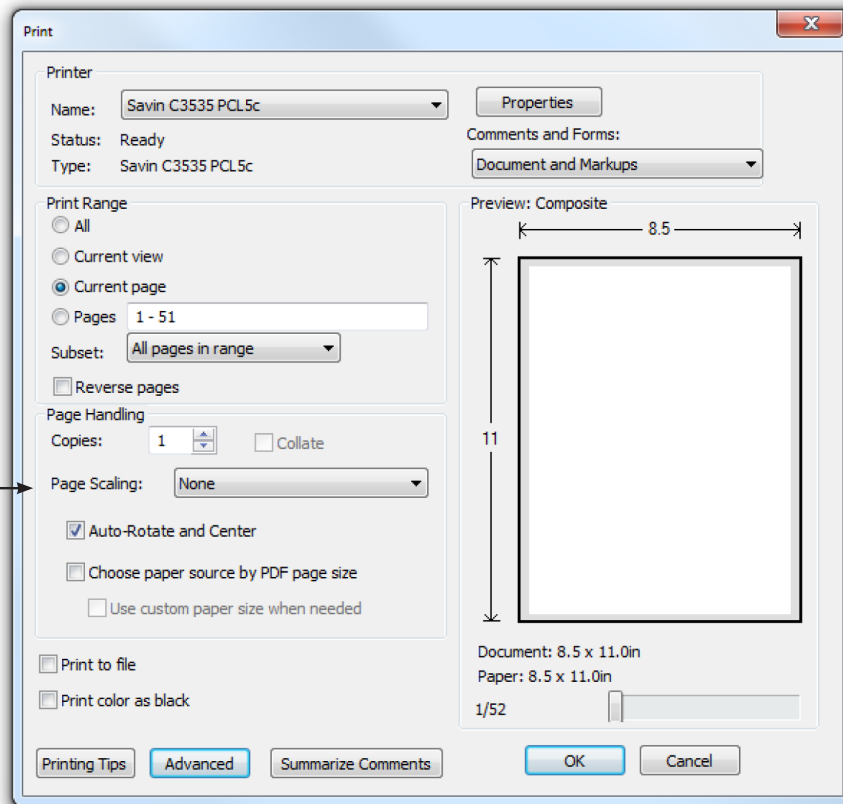

TO SAVE PAPER

Only print the desired image by navigating to the image's page, go to File > Print and select "Current page" in the print dialog box. Repeat for each desired image.

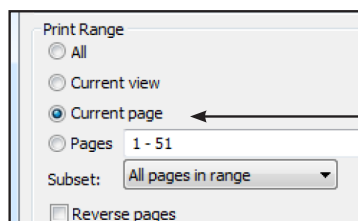

APPLIQUE PATTERNS



Print at 100%. No scaling. This box measures 1" x 1". Use the box as an accuracy guide when printing templates.

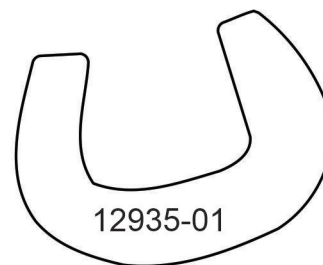
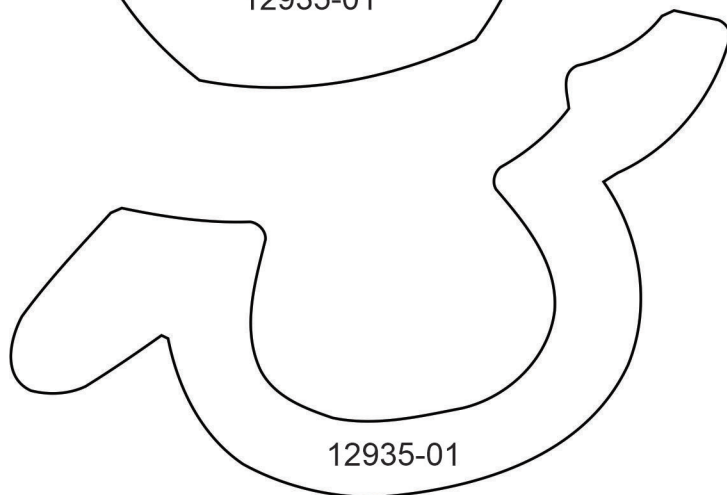
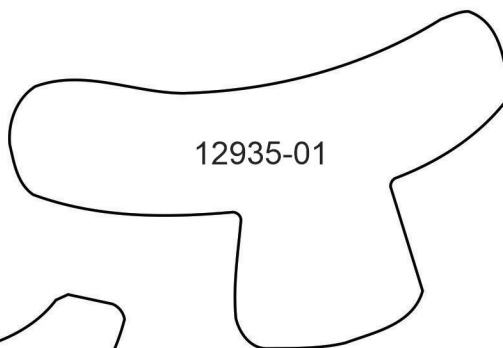
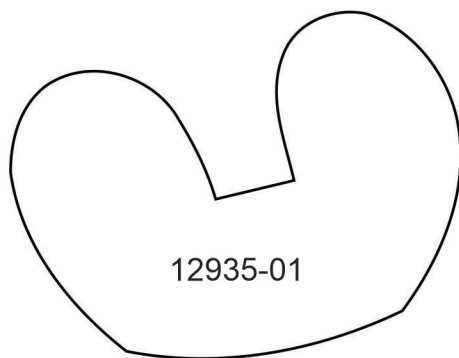
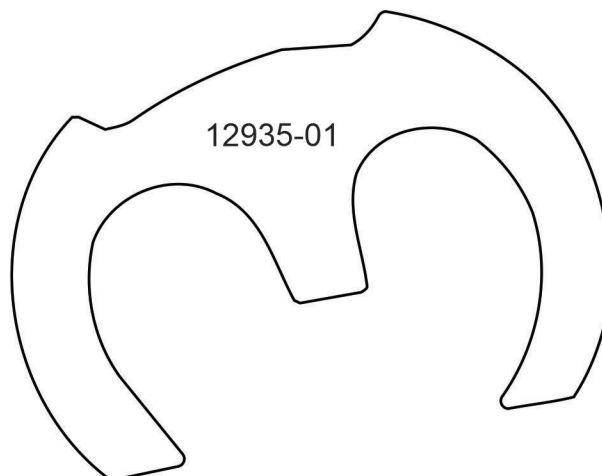

APPLIQUE PATTERNS



Print at 100%. No scaling. This box measures 1" x 1". Use the box as an accuracy guide when printing templates.

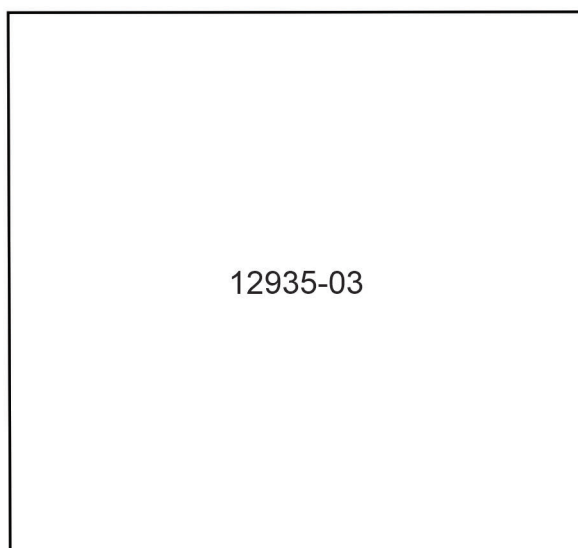
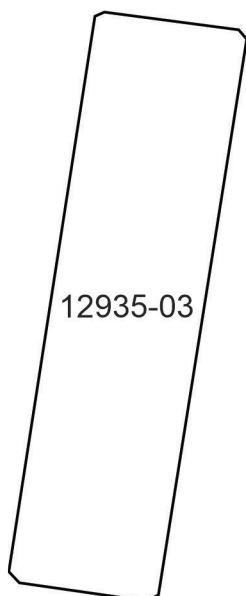
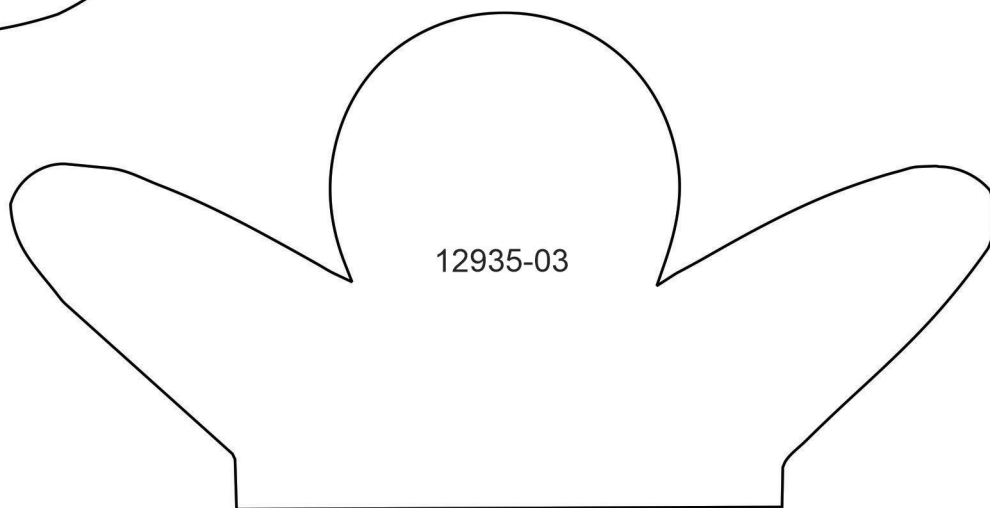
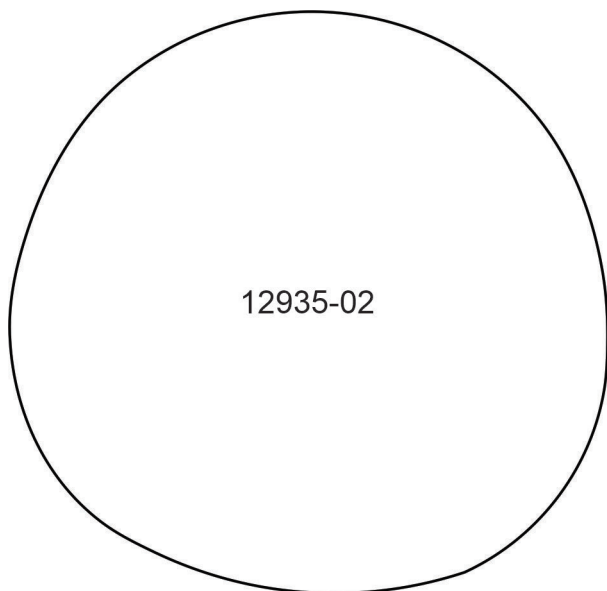

APPLIQUE PATTERNS



Print at 100%. No scaling. This box measures 1" x 1". Use the box as an accuracy guide when printing templates.

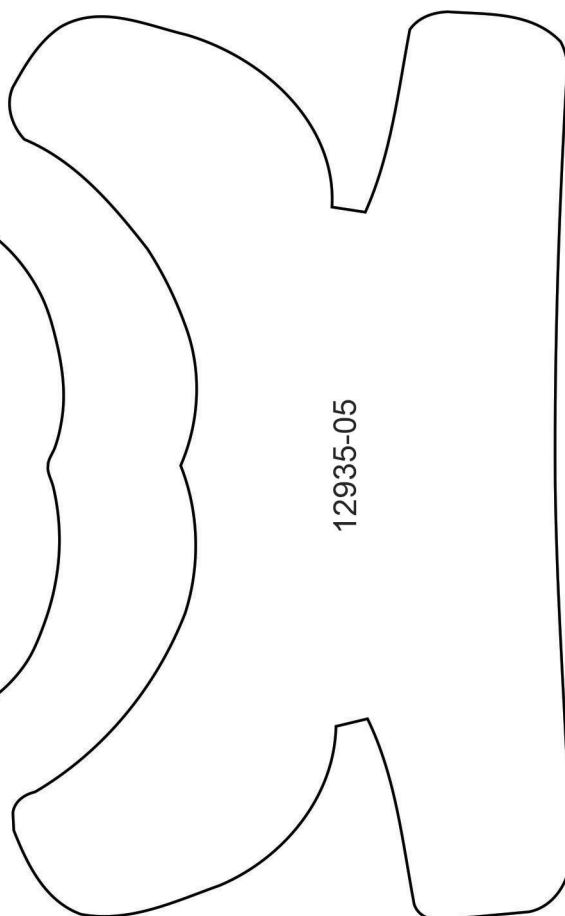
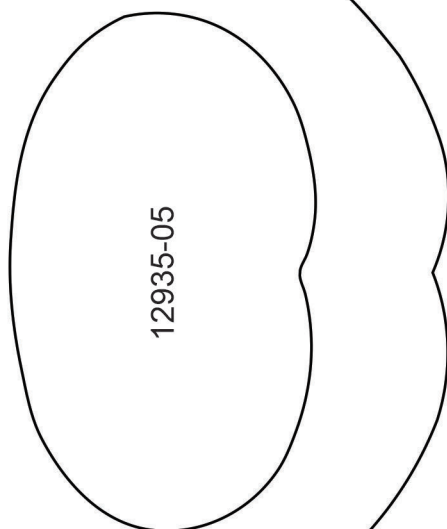
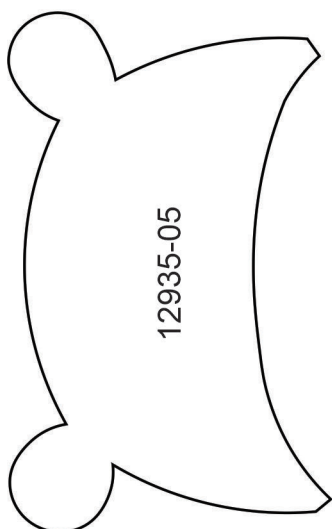

APPLIQUE PATTERNS



Print at 100%. No scaling. This box measures 1" x 1". Use the box as an accuracy guide when printing templates.

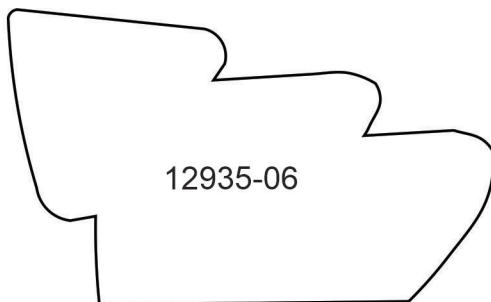

12935-06

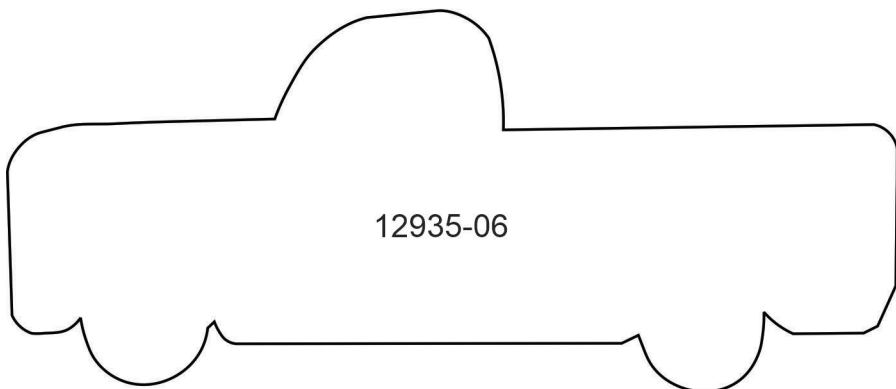

12935-06

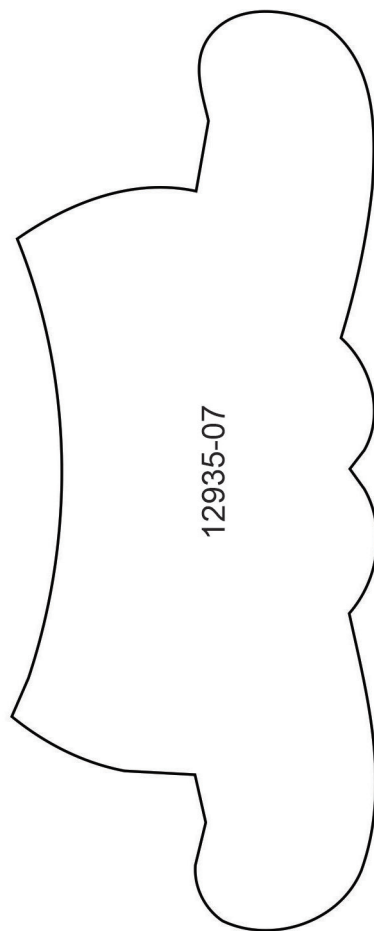

12935-07

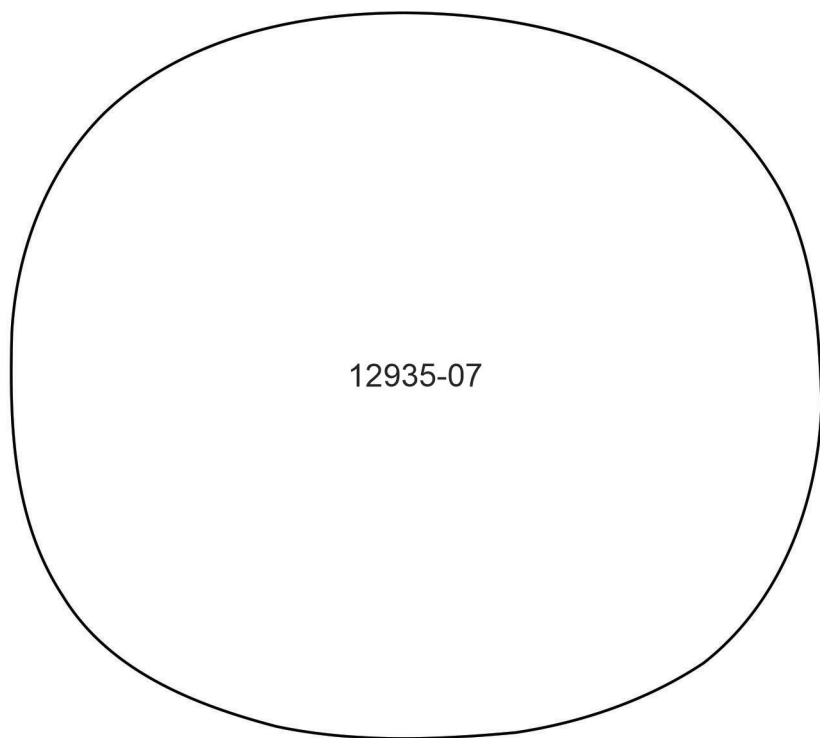

12935-07

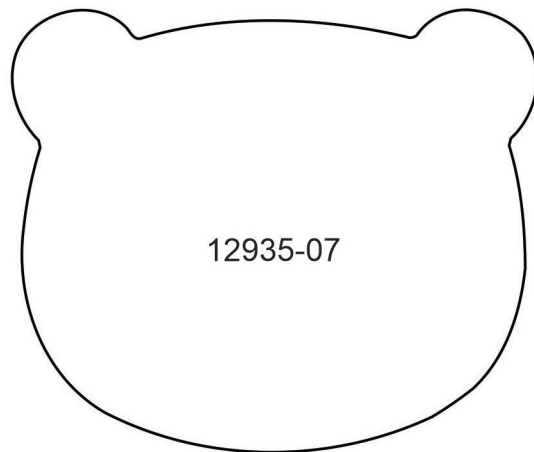

12935-07

APPLIQUE PATTERNS



Print at 100%. No scaling. This box measures 1" x 1". Use the box as an accuracy guide when printing templates.

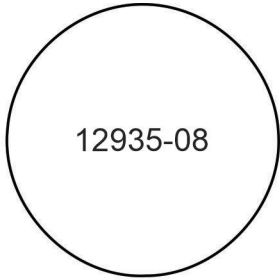

12935-08

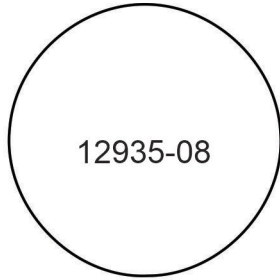

12935-08

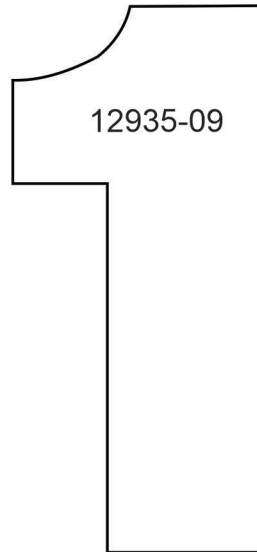

12935-09

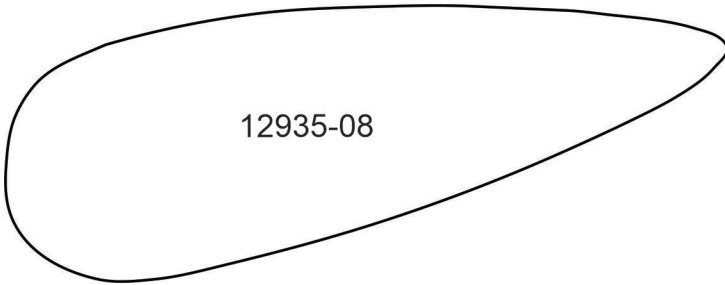

12935-08

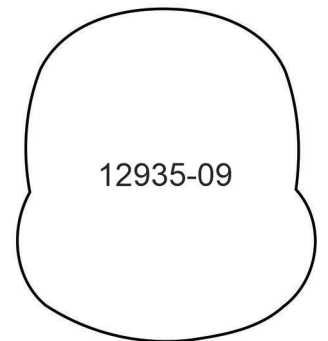

12935-09

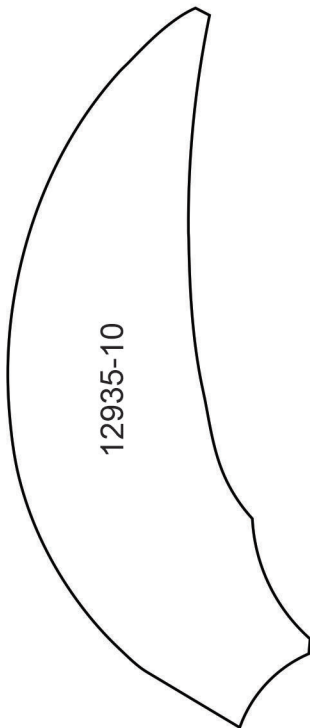

12935-10

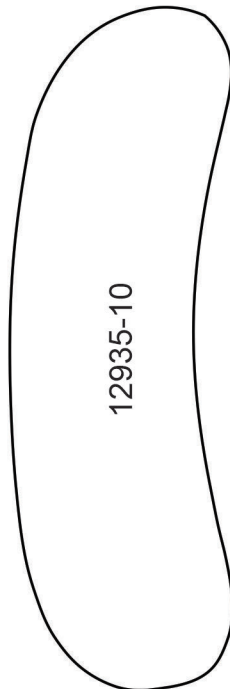

12935-10

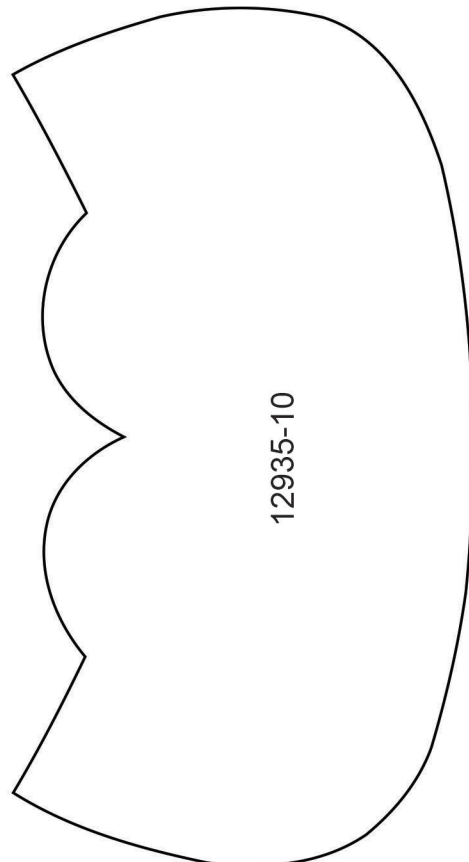

12935-10

MIRRORED PATTERNS



Print at 100%. No scaling. This box measures 1" x 1". Use the box as an accuracy guide when printing templates.

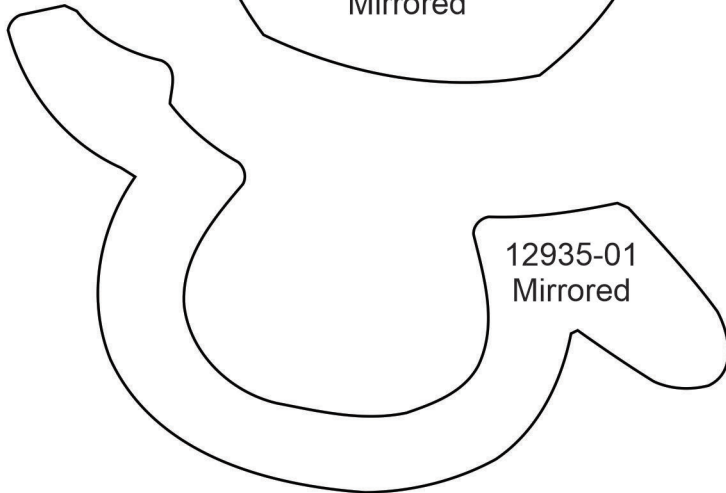
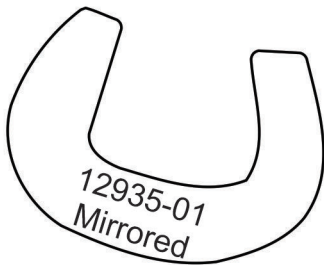
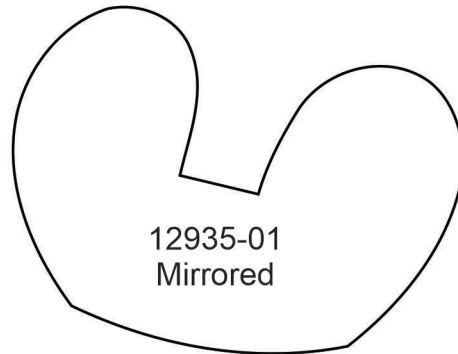
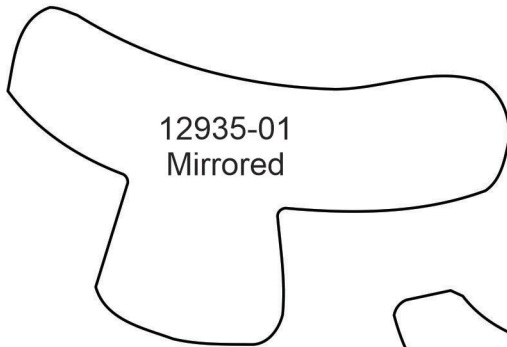
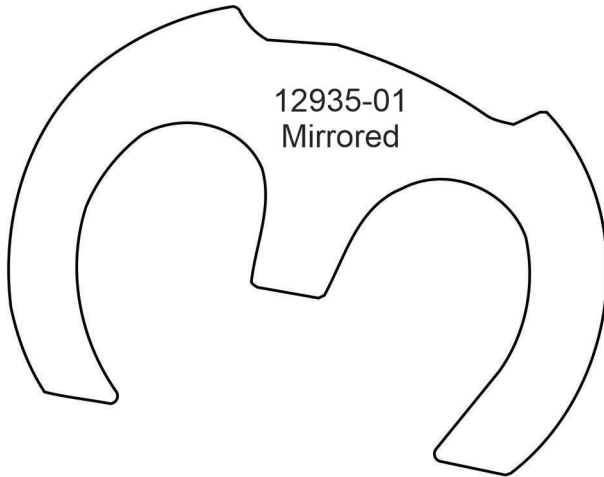

MIRRORED PATTERNS



Print at 100%. No scaling. This box measures 1" x 1". Use the box as an accuracy guide when printing templates.

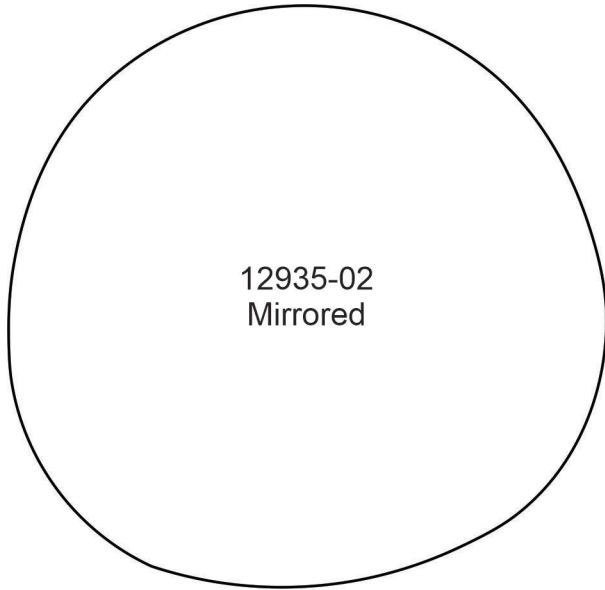

12935-02
Mirrored

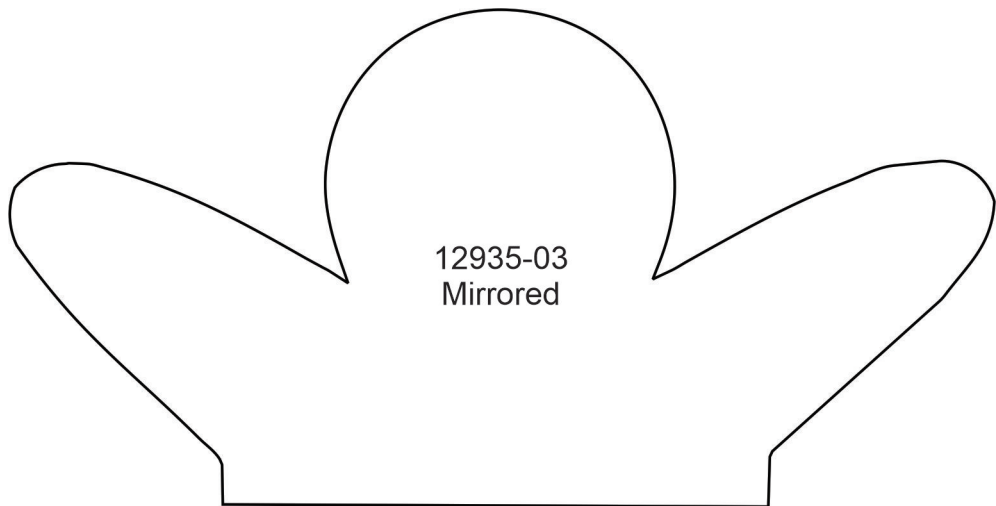

12935-03
Mirrored

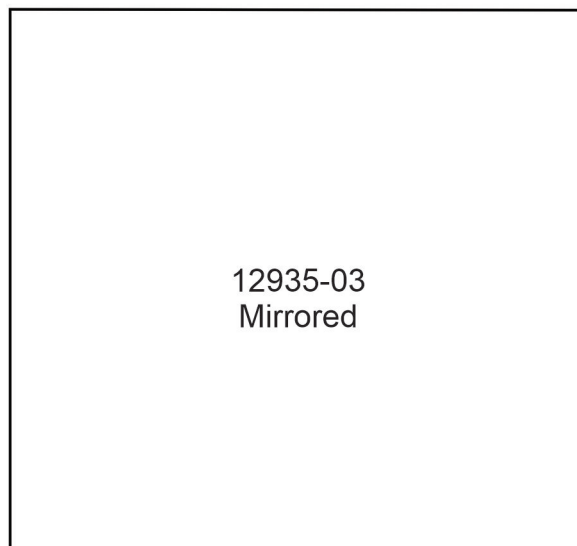

12935-03
Mirrored

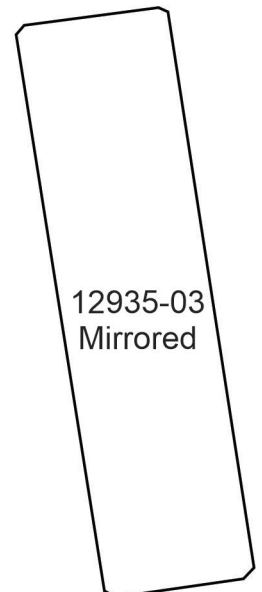

12935-03
Mirrored

MIRRORED PATTERNS



Print at 100%. No scaling. This box measures 1" x 1". Use the box as an accuracy guide when printing templates.

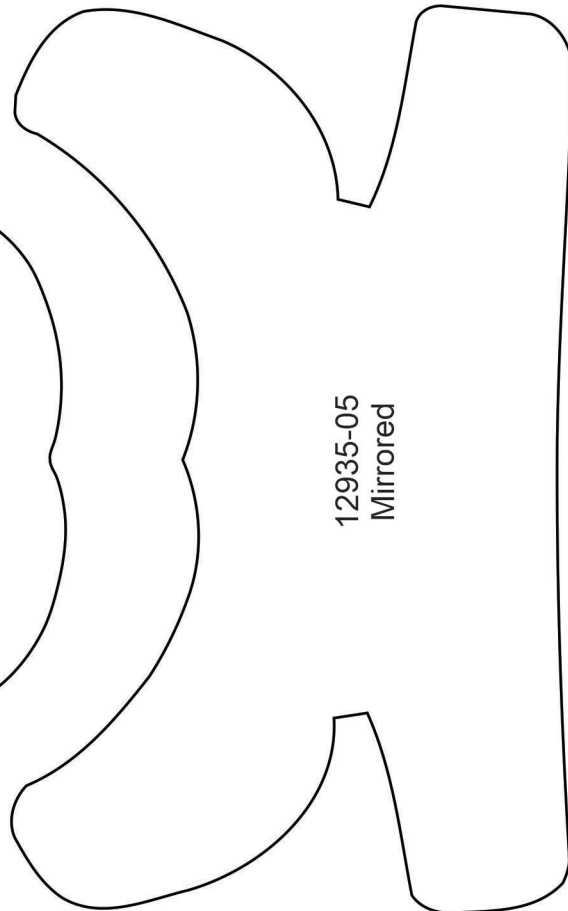
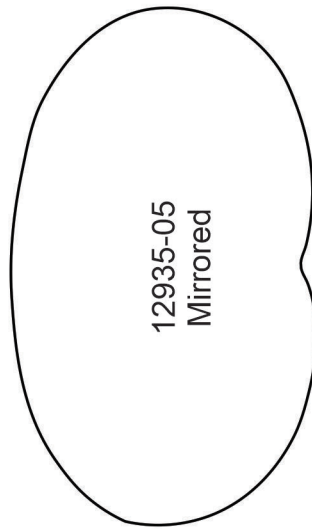
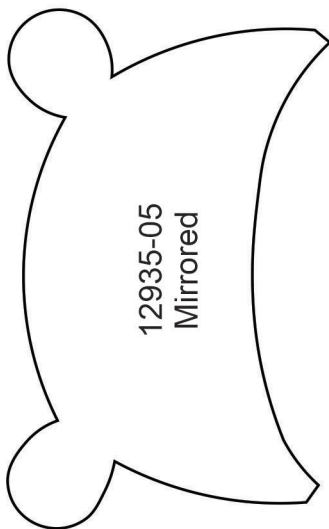

MIRRORED PATTERNS



Print at 100%. No scaling. This box measures 1" x 1". Use the box as an accuracy guide when printing templates.

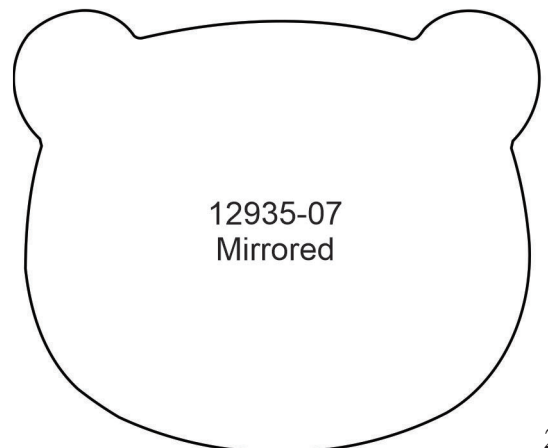
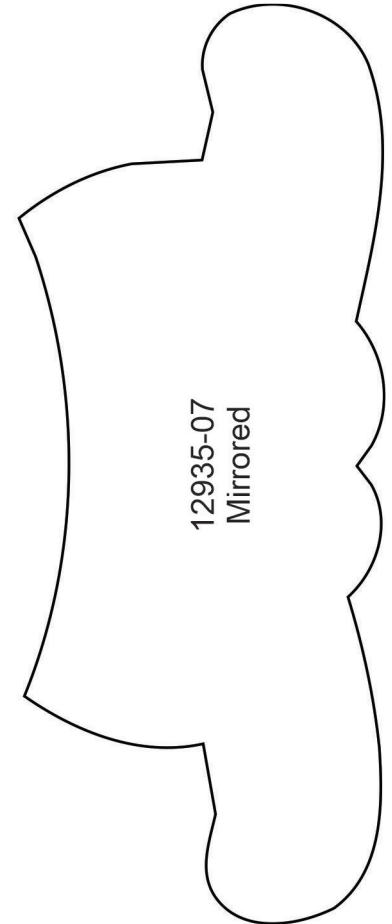
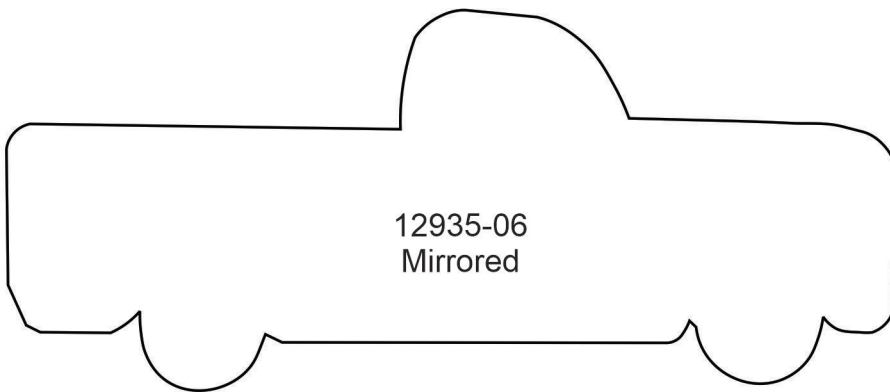
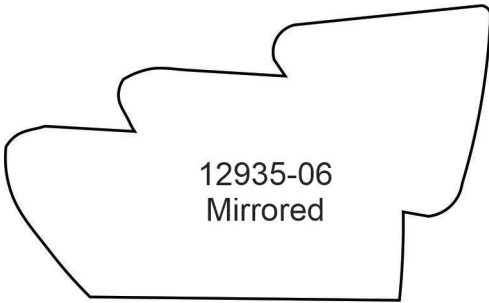

MIRRORED PATTERNS



Print at 100%. No scaling. This box measures 1" x 1". Use the box as an accuracy guide when printing templates.

