



Mascot Appliques



Collection No. 13035
15 Designs

MATERIALS



Isacord Thread Colors

- 0015 White
- 0504 Mimosa
- 0555 Light Sage
- 0731 Applesauce
- 1123 Caramel Cream
- 1200 Sunset Orange
- 1321 Dark Orange
- 1903 Lipstick
- 1950 Tropical Pink
- 2101 Country Red
- 2721 Very Berry
- 3353 Light Midnight
- 3355 Dark Indigo
- 3652 Baby Blue
- 3762 Country Blue
- 5500 Limedrop

Note: One spool of 1000 meter thread is adequate for the project unless otherwise noted.



MATERIALS



Stabilizers

- OEESD BadgeMaster WashAway
- OEESD Fuse and Seal

Fabrics/Textiles

- PolyPatch Twill in desired mascot colors

Notions & Tools

- OEESD Grippy Grid
- OEESD Expert Embroidery Tape TearAway
- OEESD Expert Embroidery Tape WashAway
- OEESD Perfect Embroidery Press Cloth

Isacord Thread Colors

- Per the thread chart



SUMMARY



13035-01



Design Size:
4.17 X 3.62 in.

13035-02



Design Size:
4.07 X 4.06 in.

13035-03



Design Size:
3.71 X 3.70 in.

13035-04



Design Size:
3.98 X 3.75 in.

13035-05



Design Size:
3.88 X 4.03 in.

13035-06



Design Size:
3.96 X 4.54 in.



SUMMARY



13035-07



Design Size:
3.47 X 4.40 in.

13035-08



Design Size:
3.98 X 5.24 in.

13035-09



Design Size:
4.58 X 4.28 in.

13035-10



Design Size:
4.18 X 3.57 in.

13035-11



Design Size:
4.94 X 3.38 in.

13035-12



Design Size:
4.05 X 4.03 in.

13035-13



Design Size:
3.83 X 3.75 in.

13035-14



Design Size:
4.08 X 3.92 in.

13035-15



Design Size:
3.73 X 3.97 in.



General Instructions

The patch instructions, included in the collection, are general instructions. For demonstration purposes, a sample design that best demonstrates the technique is shown. Design 13035-13 is shown here. Fabric and thread requirements will vary by design, but the general technique is the same. Applique technique shown is cut in place. Pre-cut applique patterns are included at the end of the instructions.

Note: Some thread colors in the instructions have been changed or digitally enhanced for better visibility.

Step 1

- Cut the Poly Patch Twill Fabric 1/4" - 1/2" larger than the applique patterns. The applique patterns are included at the end of the instructions.

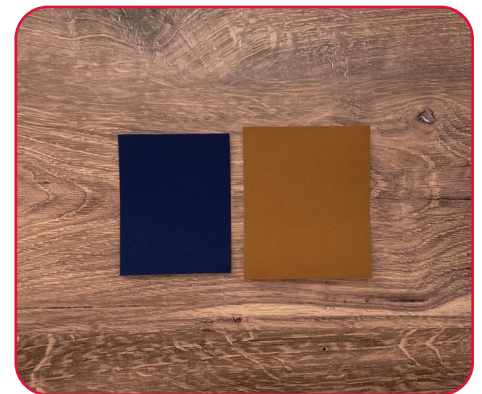

EMBROIDERY- PATCH



Step 2

- Using the OESD Grippy Grid, hoop two layers of BadgeMaster.

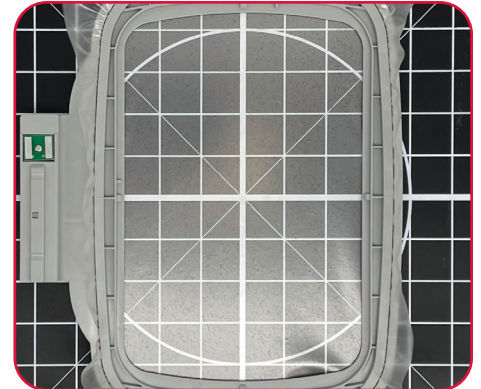

Step 3

- Load the selected design into the machine.
- Example design is 13035-13.
- Thread the machine per the thread chart.
- Place the hoop on the machine.
- Stitch Machine Step 1, Dark Blue Fabric Placement Stitch.



Step 4

- Remove the hoop from the machine, but NOT the project from the hoop.
- Completely cover the placement stitch with the dark blue Poly Patch Twill applique fabric.
- Tape in place with OESD Expert Embroidery Tape TearAway to secure.



EMBROIDERY- PATCH



□ Step 5

- Return the hoop to the machine.
- Stitch Machine Step 2, Cut Line and Tackdown.



□ Step 6

- Remove the hoop from the machine, but NOT the project from the hoop.
- Trim the excess fabric as close to the cut line as possible. If the outermost stitches (cut line) are cut, the inner stitches (tackdown) will hold the applique in place.

 **Tip: If the stabilizer is cut or a hole is created while trimming the fabric, use OEESD Expert Embroidery Tape WashAway as a patch.**

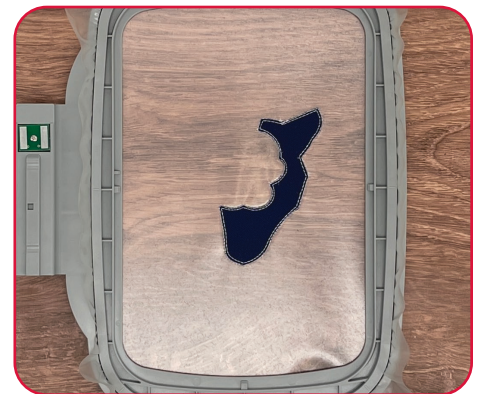

EMBROIDERY- PATCH



Step 7

- Return the hoop to the machine.
- Stitch Machine Step 2, Brown Fabric Placement Stitch.



Step 8

- Remove the hoop from the machine, but NOT the project from the hoop.
- Completely cover the placement stitch with the brown Poly Patch Twill applique fabric.
- Tape in place to secure.

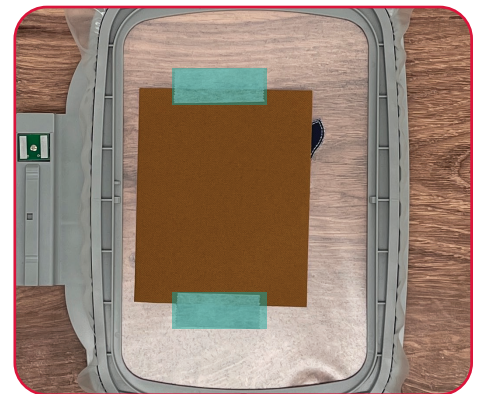

Step 9

- Return the hoop to the machine.
- Stitch Machine Step 4, Cut Line and Tackdown.



EMBROIDERY- PATCH



Step 10

- Remove the hoop from the machine, but NOT the project from the hoop.
- Trim the excess fabric as close to the cut line as possible.



Step 11

- Return the hoop to the machine.
- Stitch Machine Steps 5 – 8, **stopping before the last machine step.**



Step 12

- Stitch Machine Step 9, Cover Stitch **with matching bobbin thread.**



EMBROIDERY- PATCH



□ Step 13

- When the design is complete, remove the project from the hoop.
- Trim the stabilizer 1/4" - 1/2" outside the design or if perforated enough, BadgeMaster can be gently torn away from the design, one layer at a time.



FINISHING TOUCHES



□ Step 14

- Rinse the patch in warm running water until the design is only slightly tacky.
- Place right side down on a non-stick surface to dry. Parchment paper or a cooling rack work well. Dry completely.
- Once dry, press right side down on an OEESD Perfect Embroidery Press Cloth.



□ Step 15

- Trace the outline of the patch or print the mirrored version of the applique pattern on the paper side of Fuse and Seal.

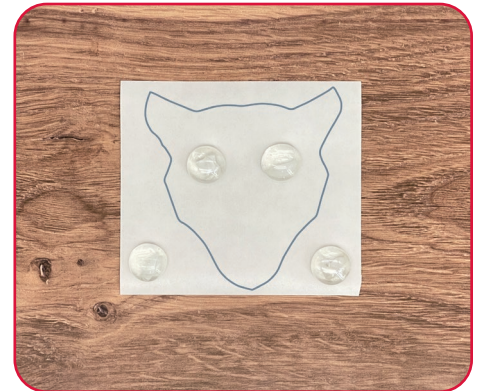

FINISHING TOUCHES

Step 16

- Trim the Fuse and Seal just inside the outline.
- Iron the Fuse and Seal to the wrong side of the patch, following the package instructions.
- Cool completely.



Step 17

- When ready to apply the patch, remove the paper backing from the Fuse and Seal.
- Place the patch on the project and press to adhere.



FINISHING TOUCHES



Step 18

- The project is complete. Enjoy!



PRINTING INSTRUCTIONS



ATTENTION

When printing this document, any page scaling or page fitting options in your print dialog box must be turned OFF or set to NONE so that your files will print out at their actual size. Images not printed at actual size will not function as intended.

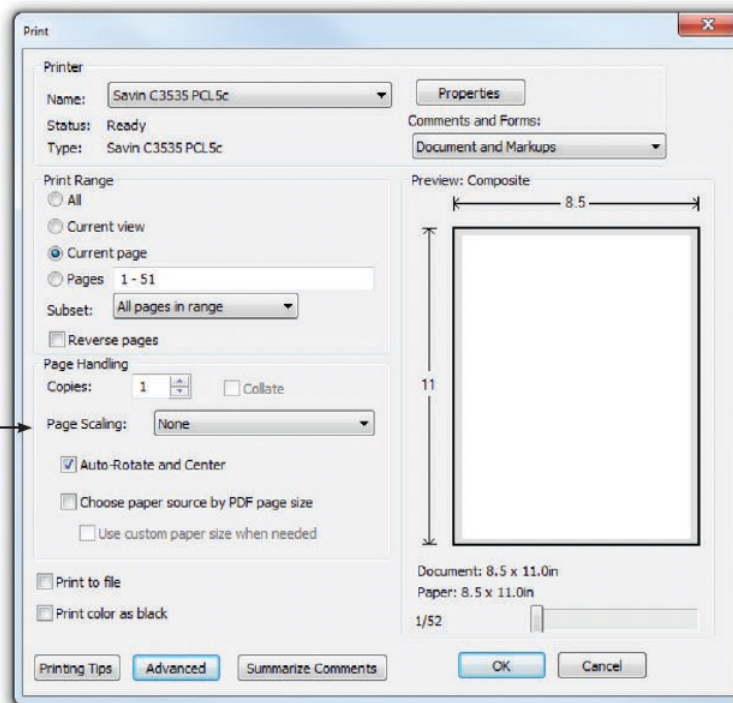

TO SAVE PAPER

Only print the desired image by navigating to the image's page, go to File > Print and select "Current page" in the print dialog box. Repeat for each desired image.

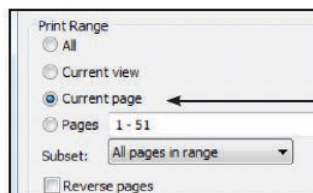

APPLIQUE PATTERNS



Print at 100%. No scaling. This box measures 1" x 1". Use the box as an accuracy guide when printing templates.

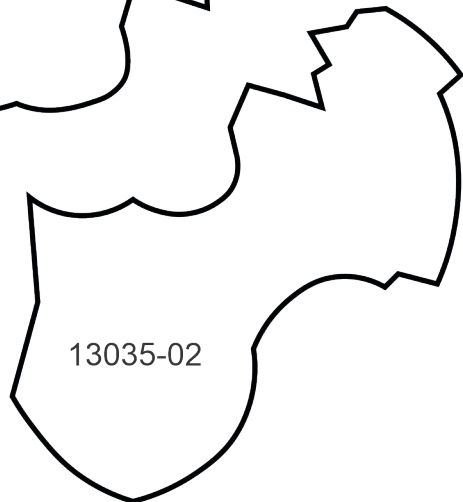
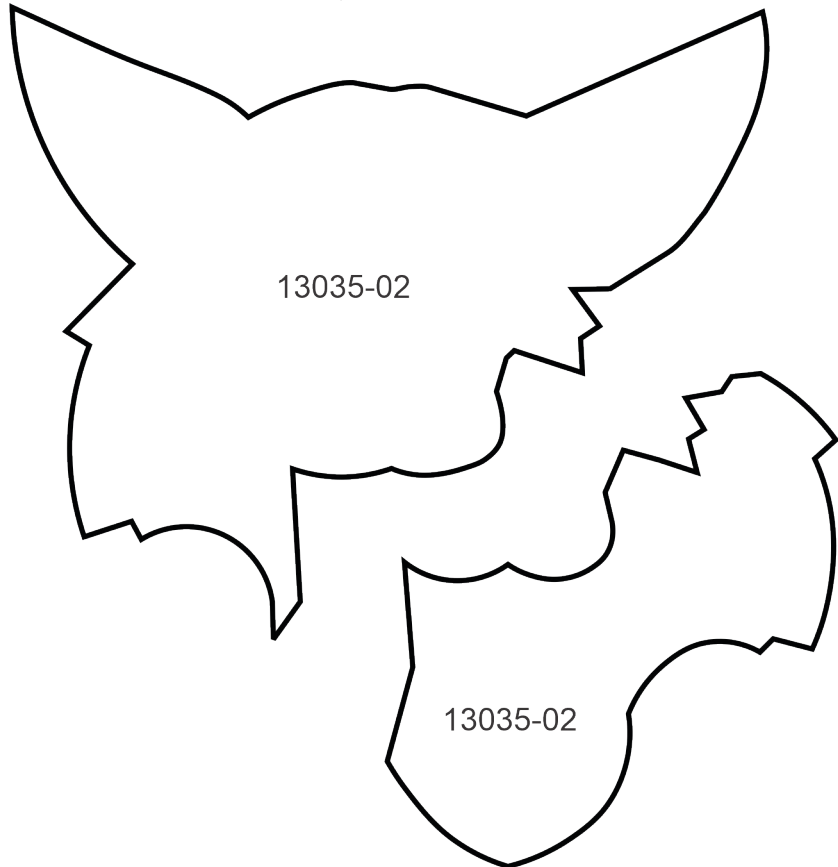
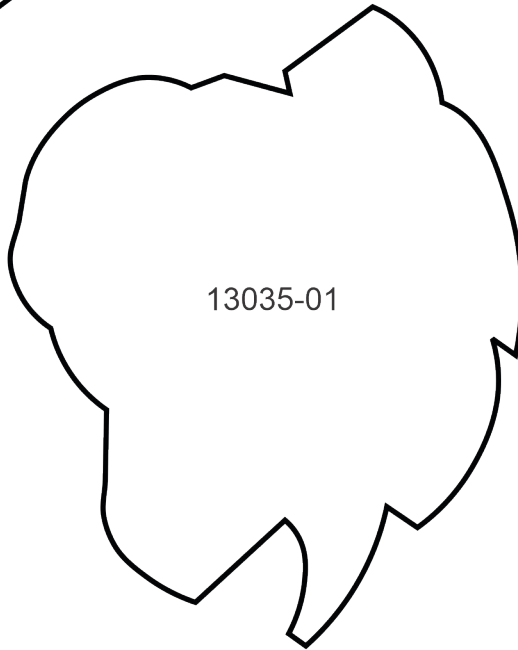
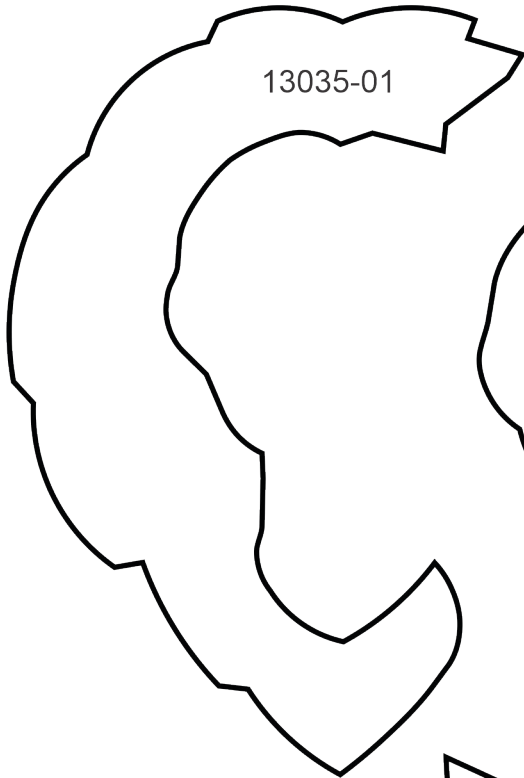

APPLIQUE PATTERNS



Print at 100%. No scaling. This box measures 1" x 1". Use the box as an accuracy guide when printing templates.

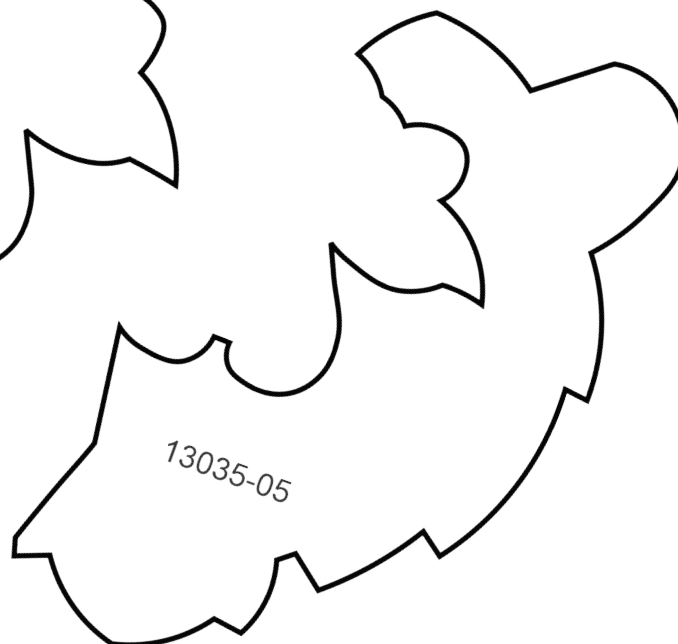
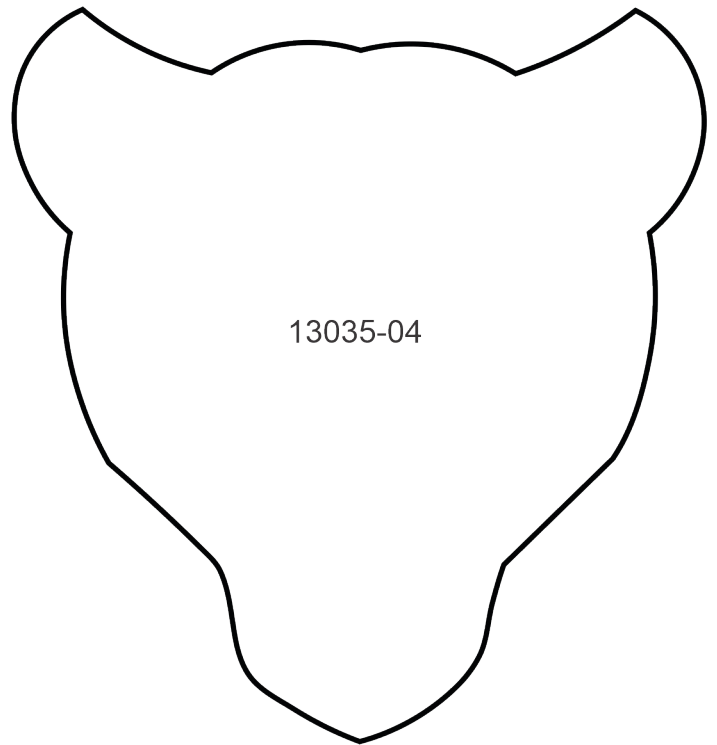
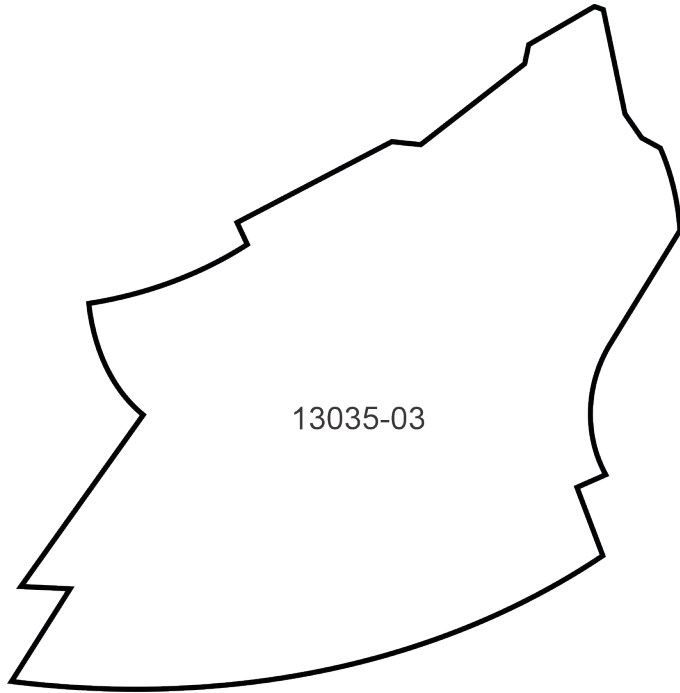

APPLIQUE PATTERNS



Print at 100%. No scaling. This box measures 1" x 1". Use the box as an accuracy guide when printing templates.

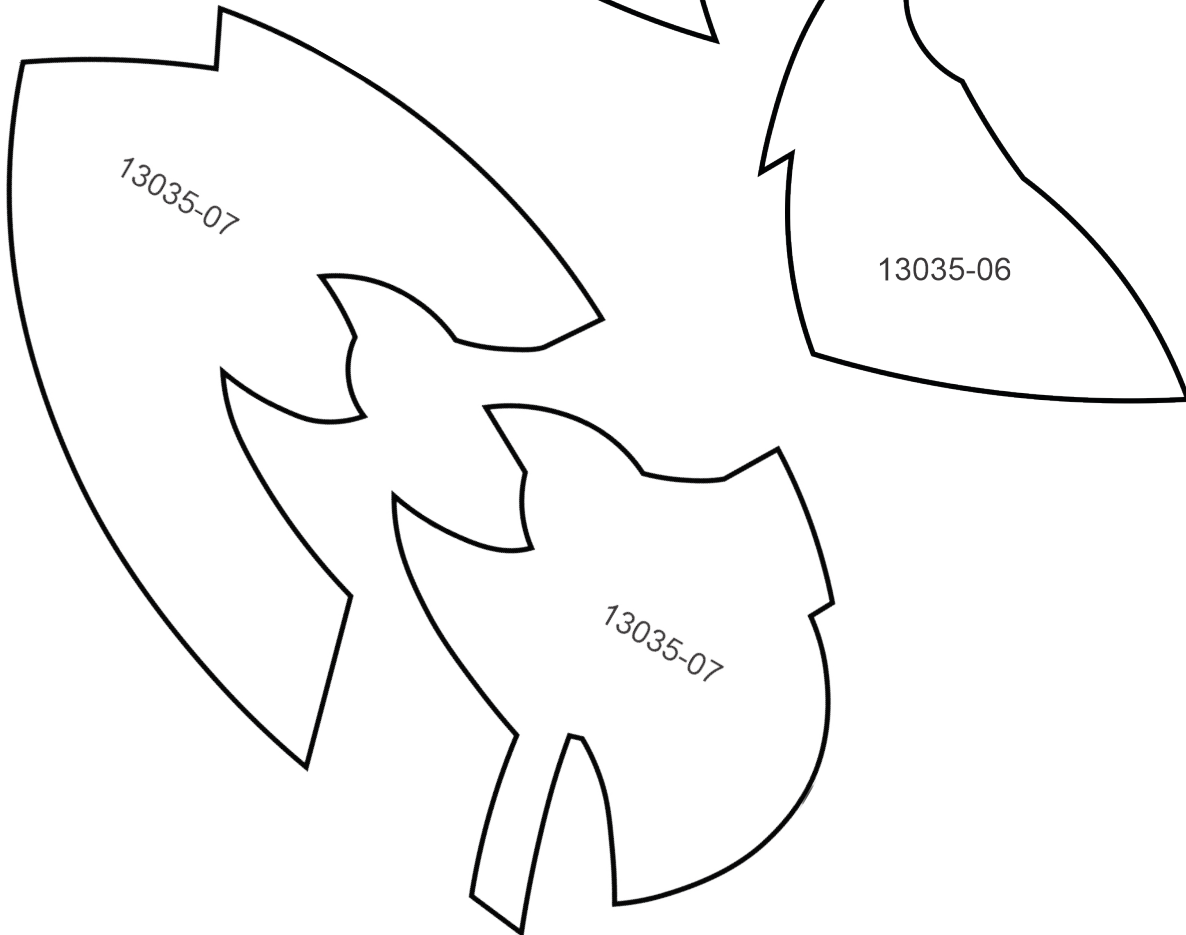

APPLIQUE PATTERNS



Print at 100%. No scaling. This box measures 1" x 1". Use the box as an accuracy guide when printing templates.

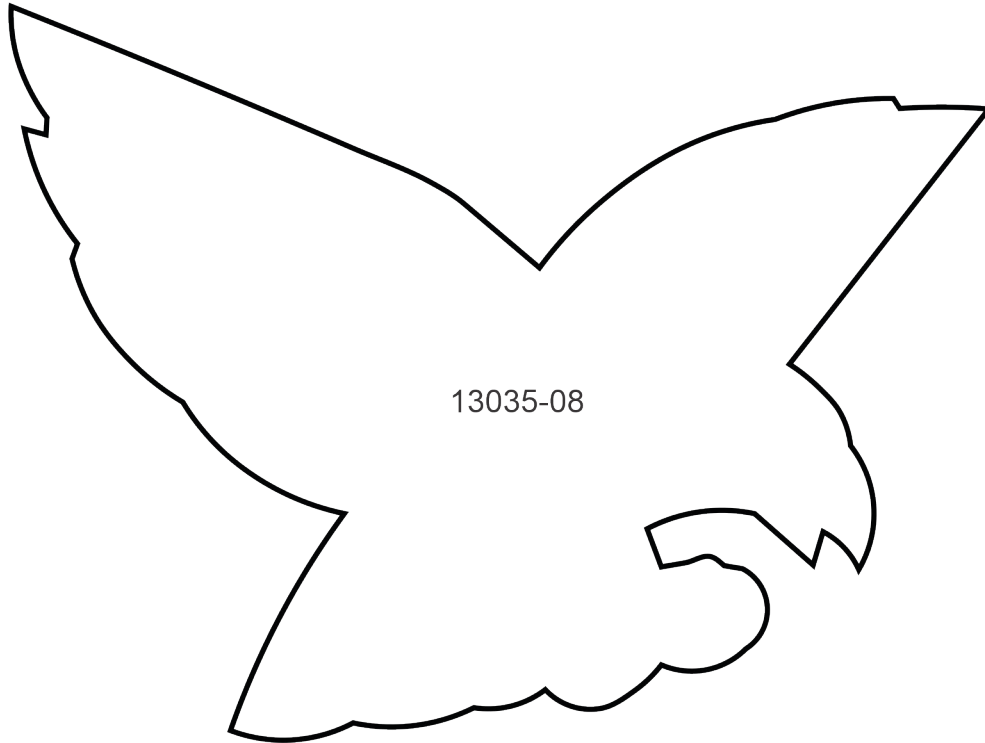

13035-08

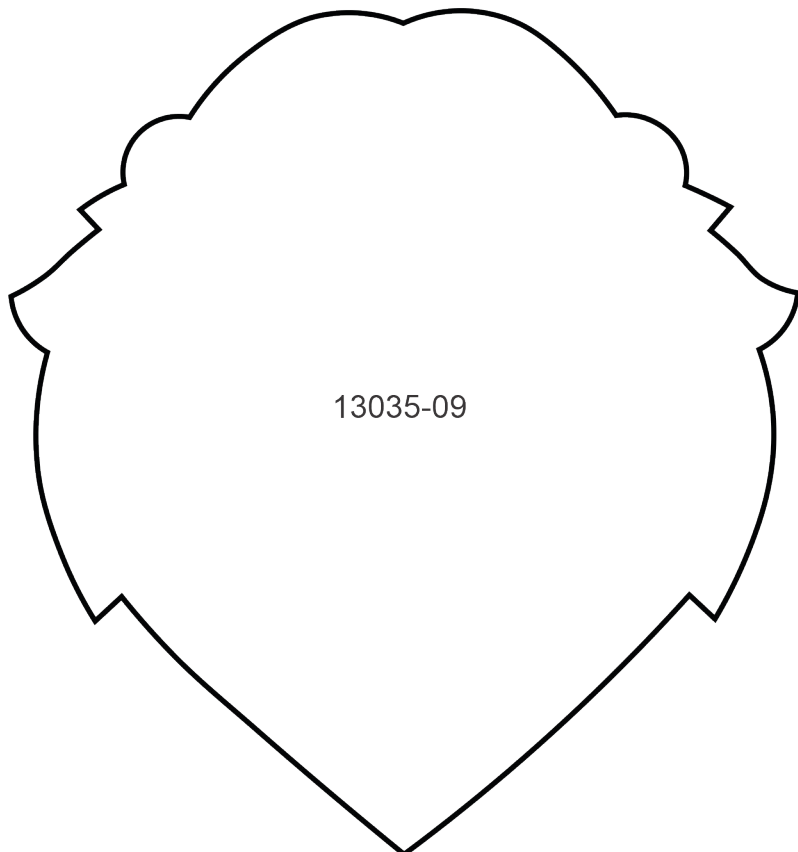

13035-09

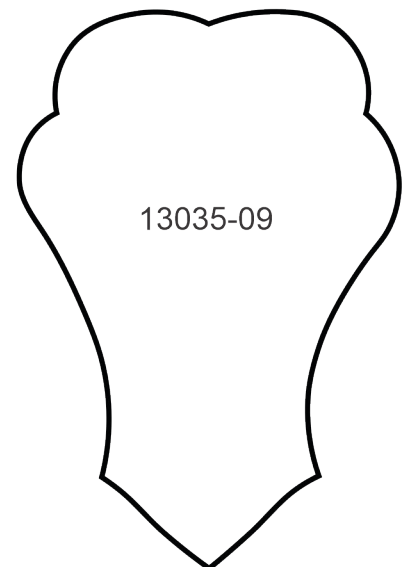

13035-09

APPLIQUE PATTERNS



Print at 100%. No scaling. This box measures 1" x 1". Use the box as an accuracy guide when printing templates.

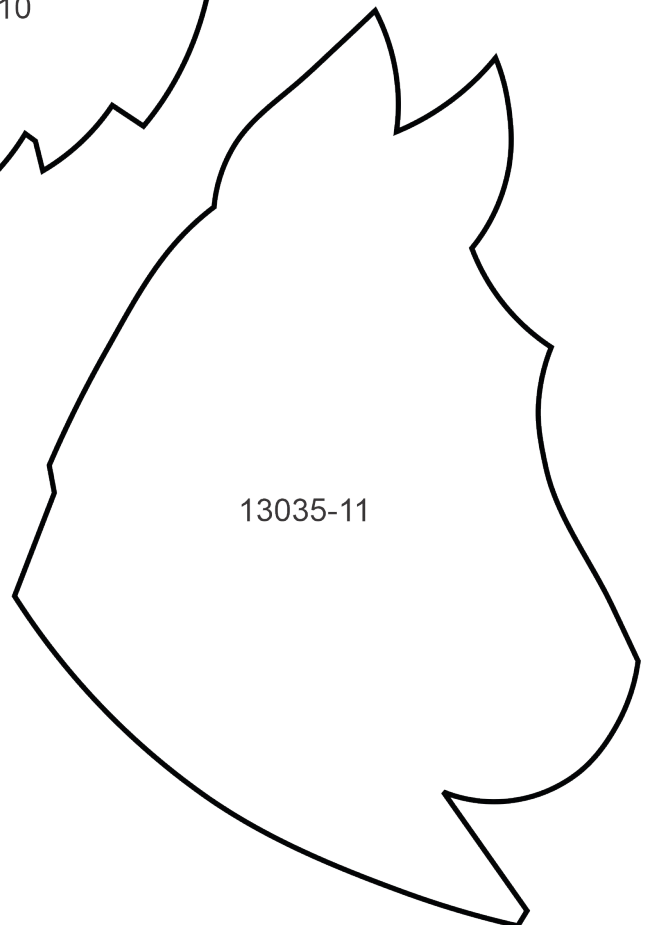
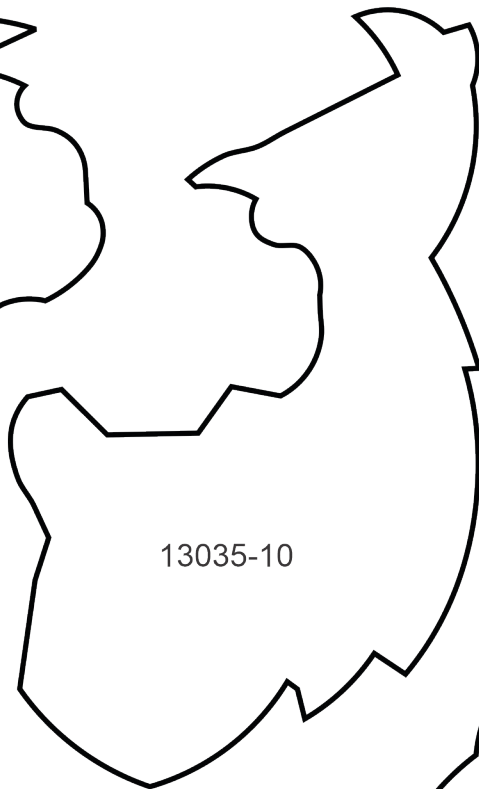
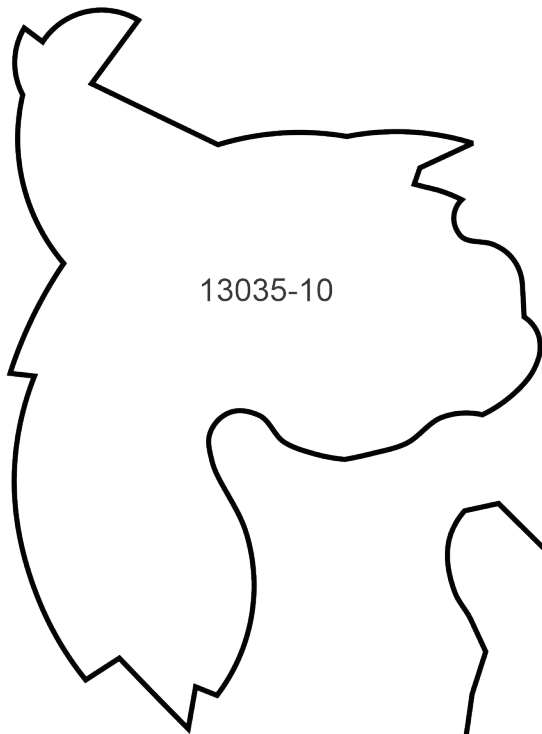

APPLIQUE PATTERNS



Print at 100%. No scaling. This box measures 1" x 1". Use the box as an accuracy guide when printing templates.

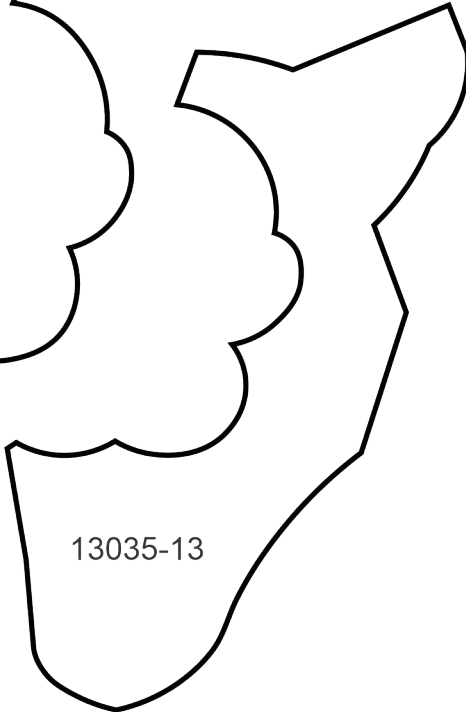
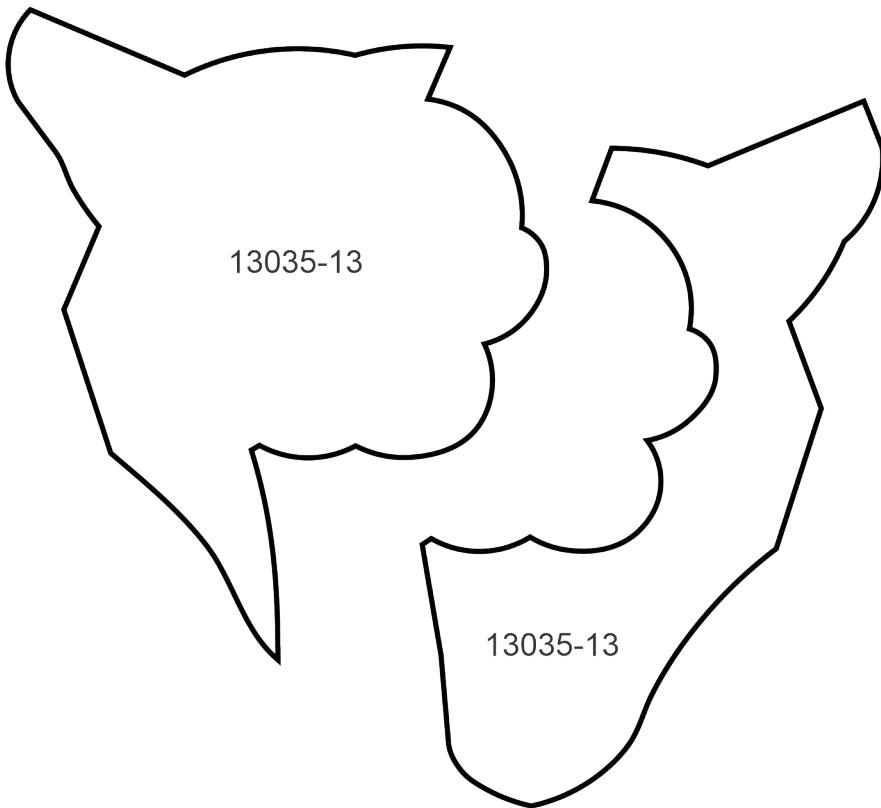
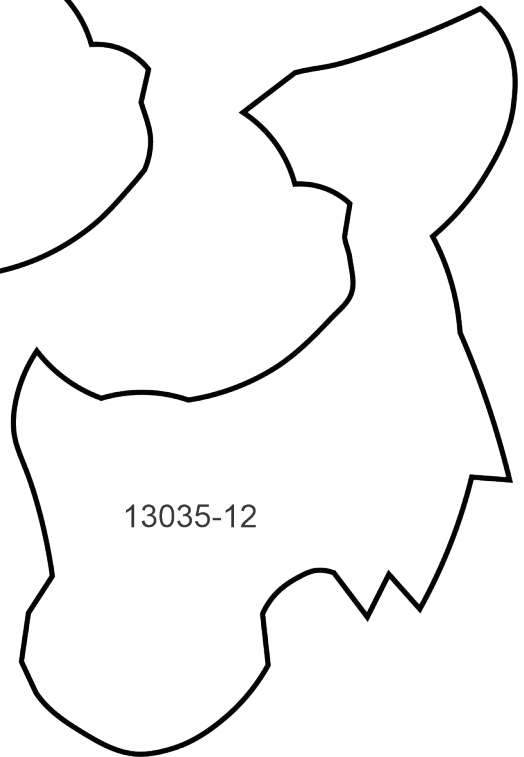
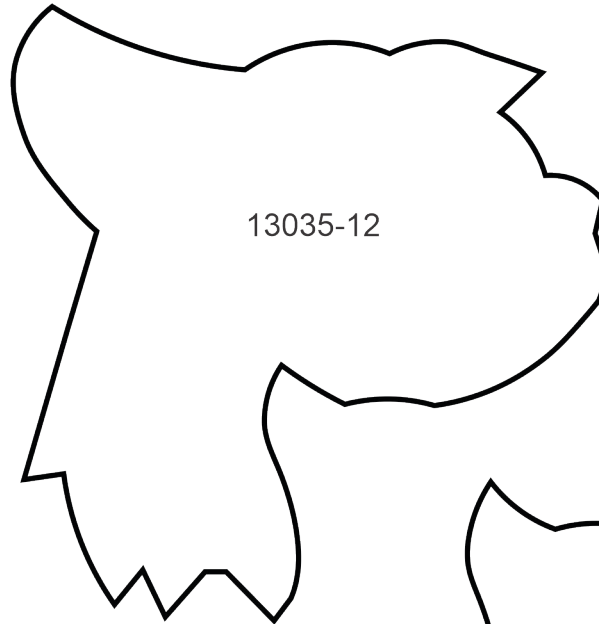

APPLIQUE PATTERNS



Print at 100%. No scaling. This box measures 1" x 1". Use the box as an accuracy guide when printing templates.

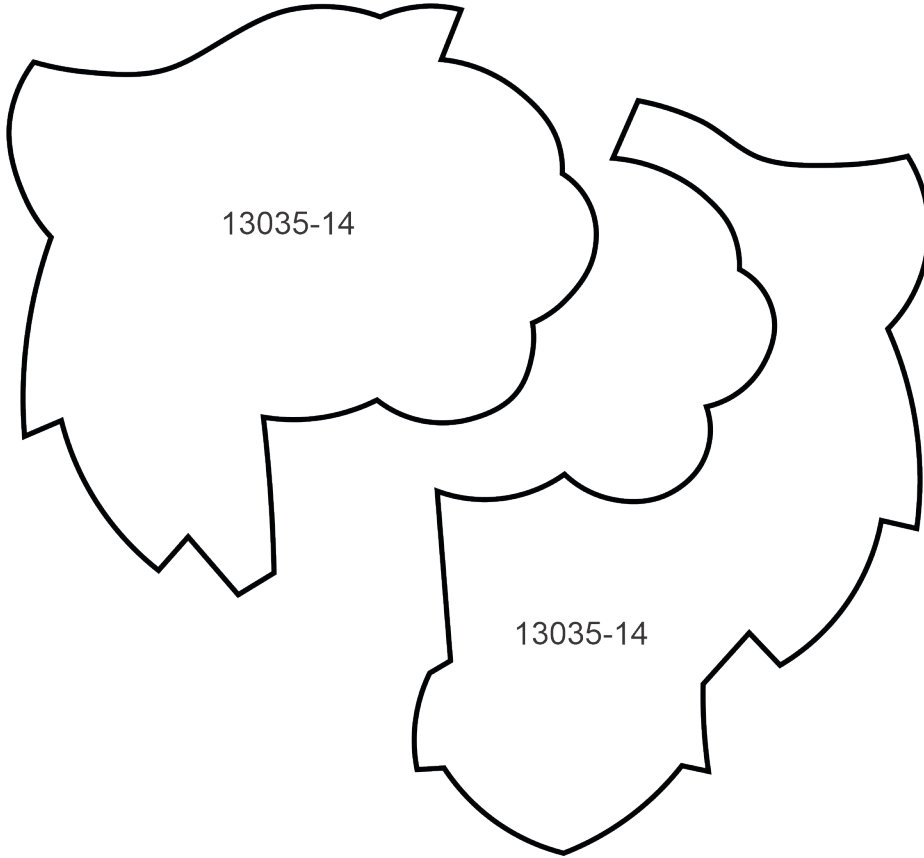

13035-14

13035-14

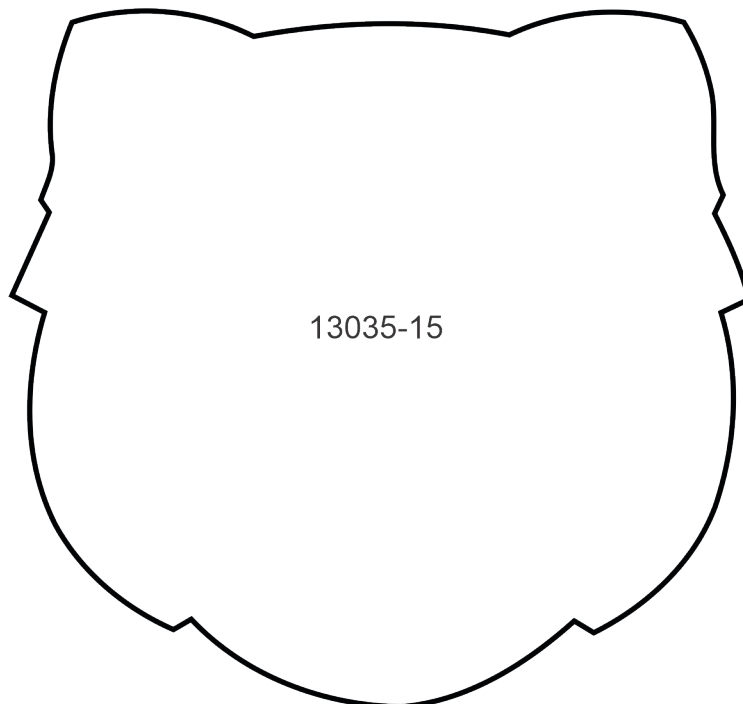

13035-15

MIRRORED PATTERNS



Print at 100%. No scaling. This box measures 1" x 1". Use the box as an accuracy guide when printing templates.

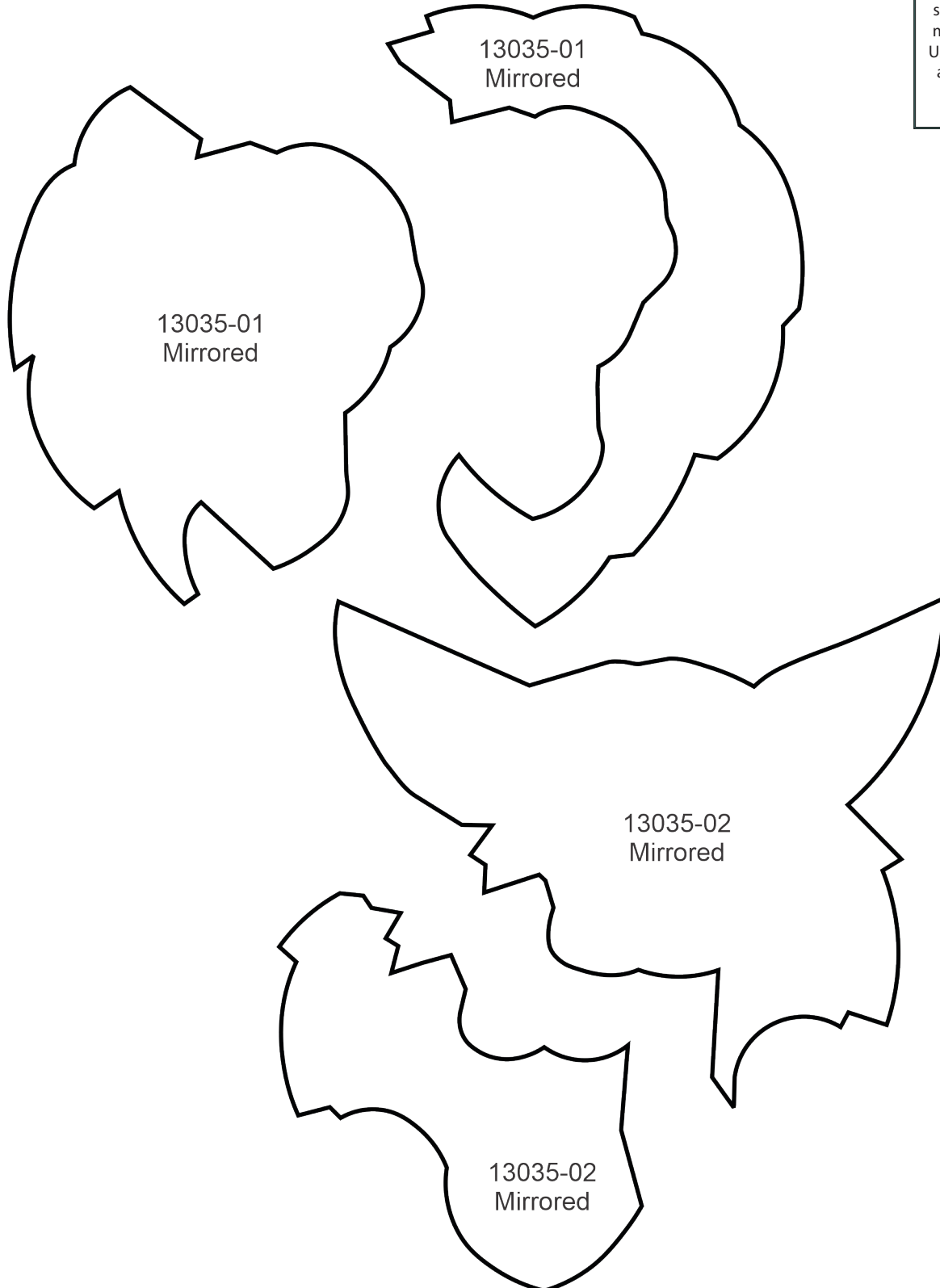

MIRRORED PATTERNS

Print at 100%. No scaling. This box measures 1" x 1". Use the box as an accuracy guide when printing templates.

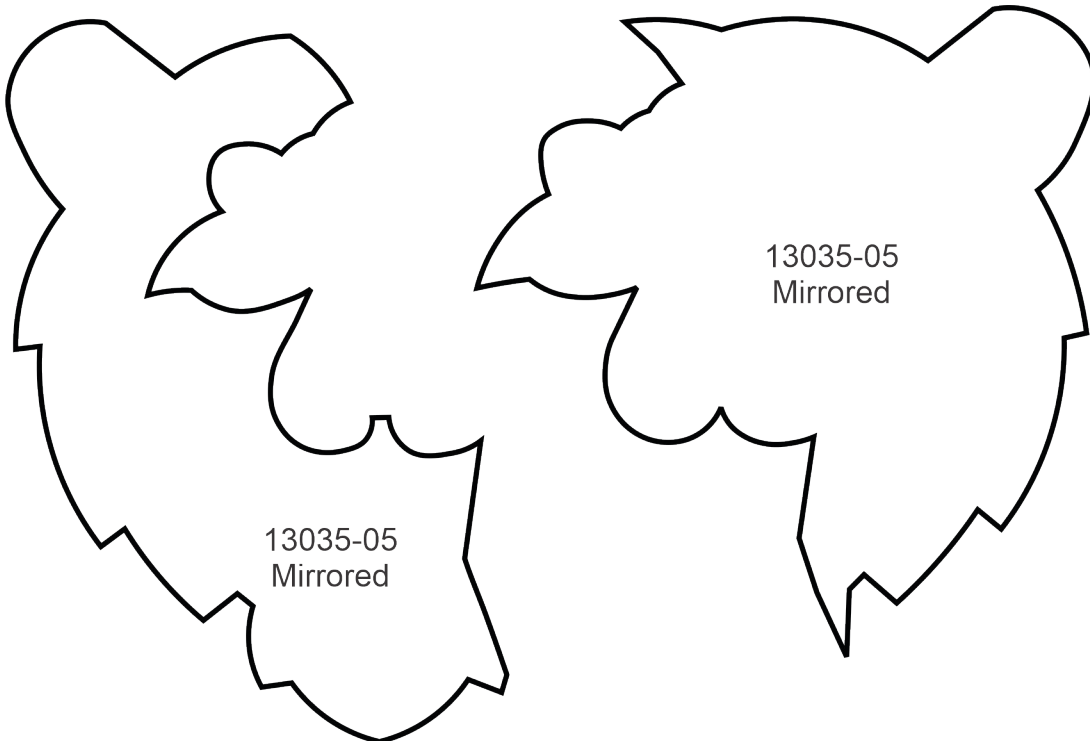
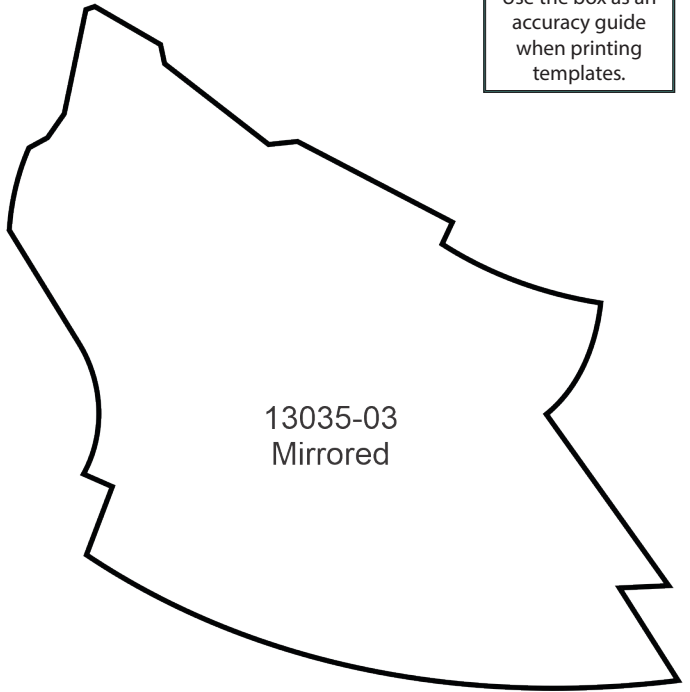
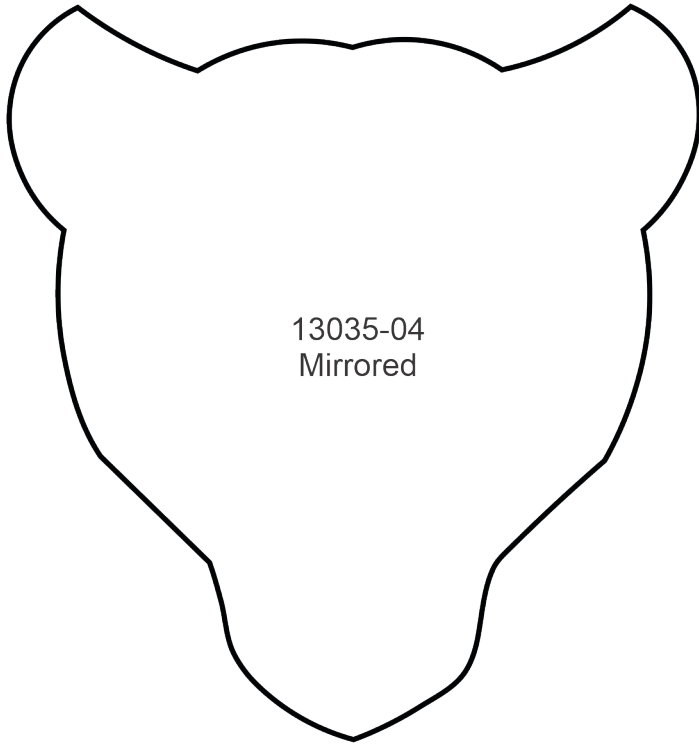

MIRRORED PATTERNS

Print at 100%. No scaling. This box measures 1" x 1". Use the box as an accuracy guide when printing templates.

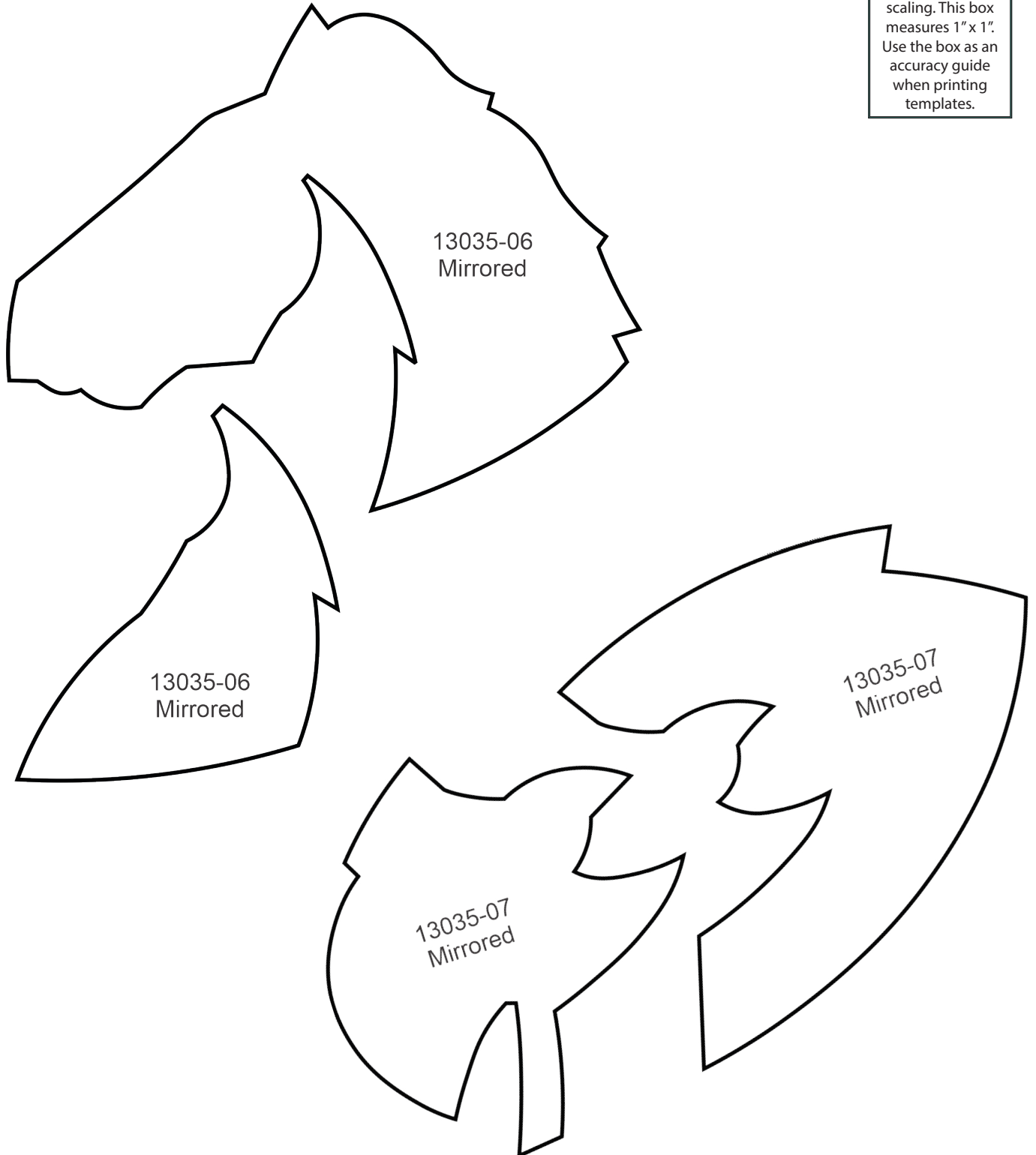

MIRRORED PATTERNS



Print at 100%. No scaling. This box measures 1" x 1". Use the box as an accuracy guide when printing templates.

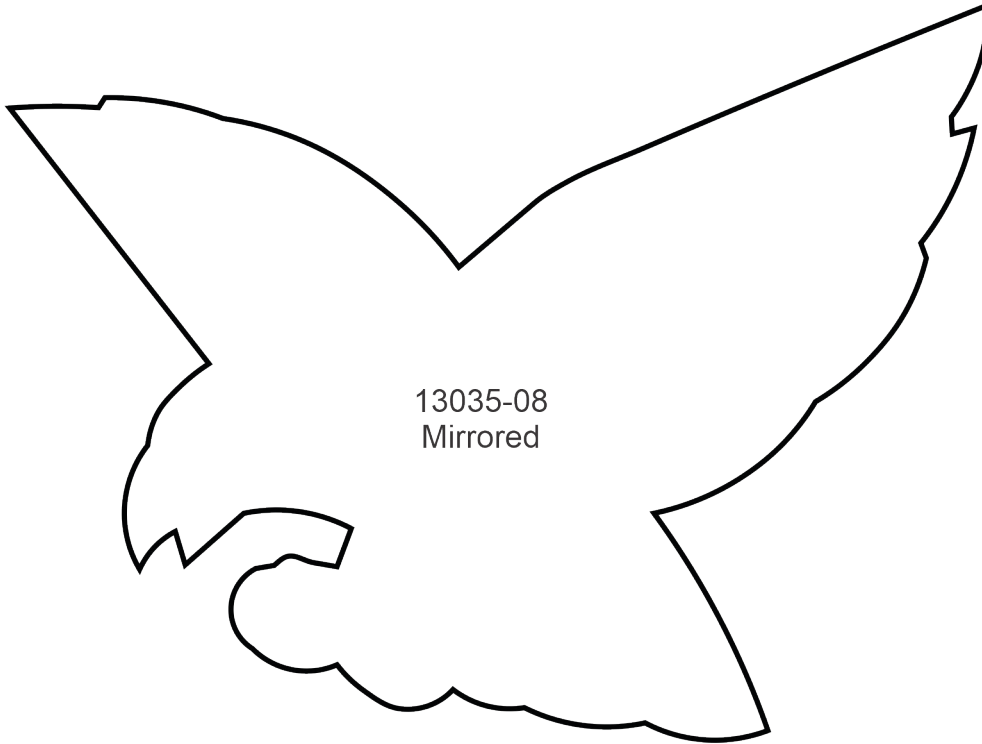

13035-08
Mirrored



13035-09
Mirrored

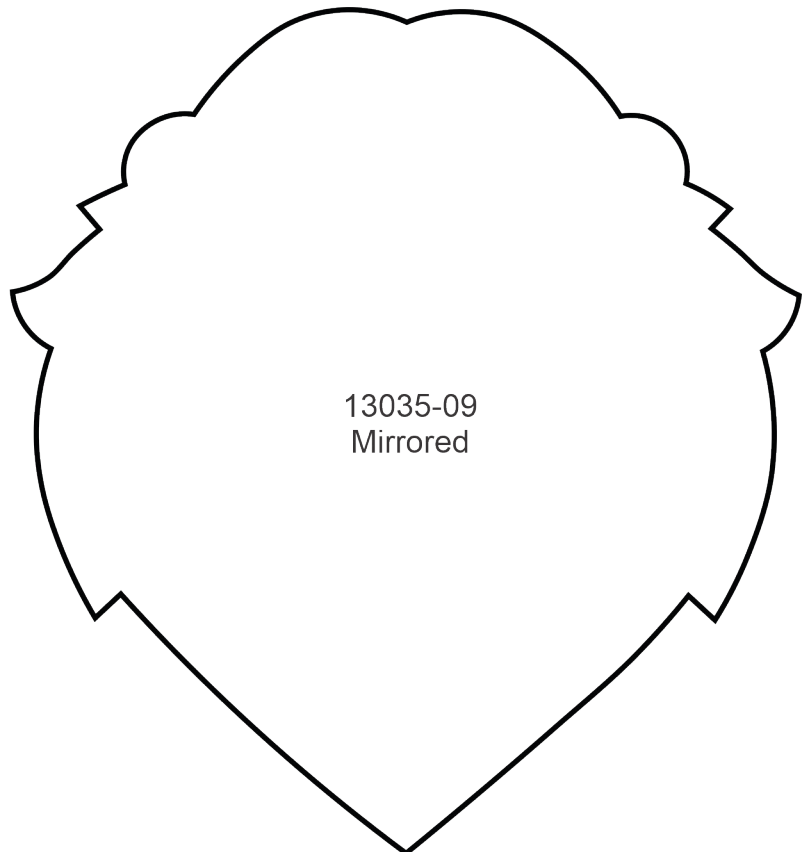

13035-09
Mirrored

MIRRORED PATTERNS



Print at 100%. No scaling. This box measures 1" x 1". Use the box as an accuracy guide when printing templates.

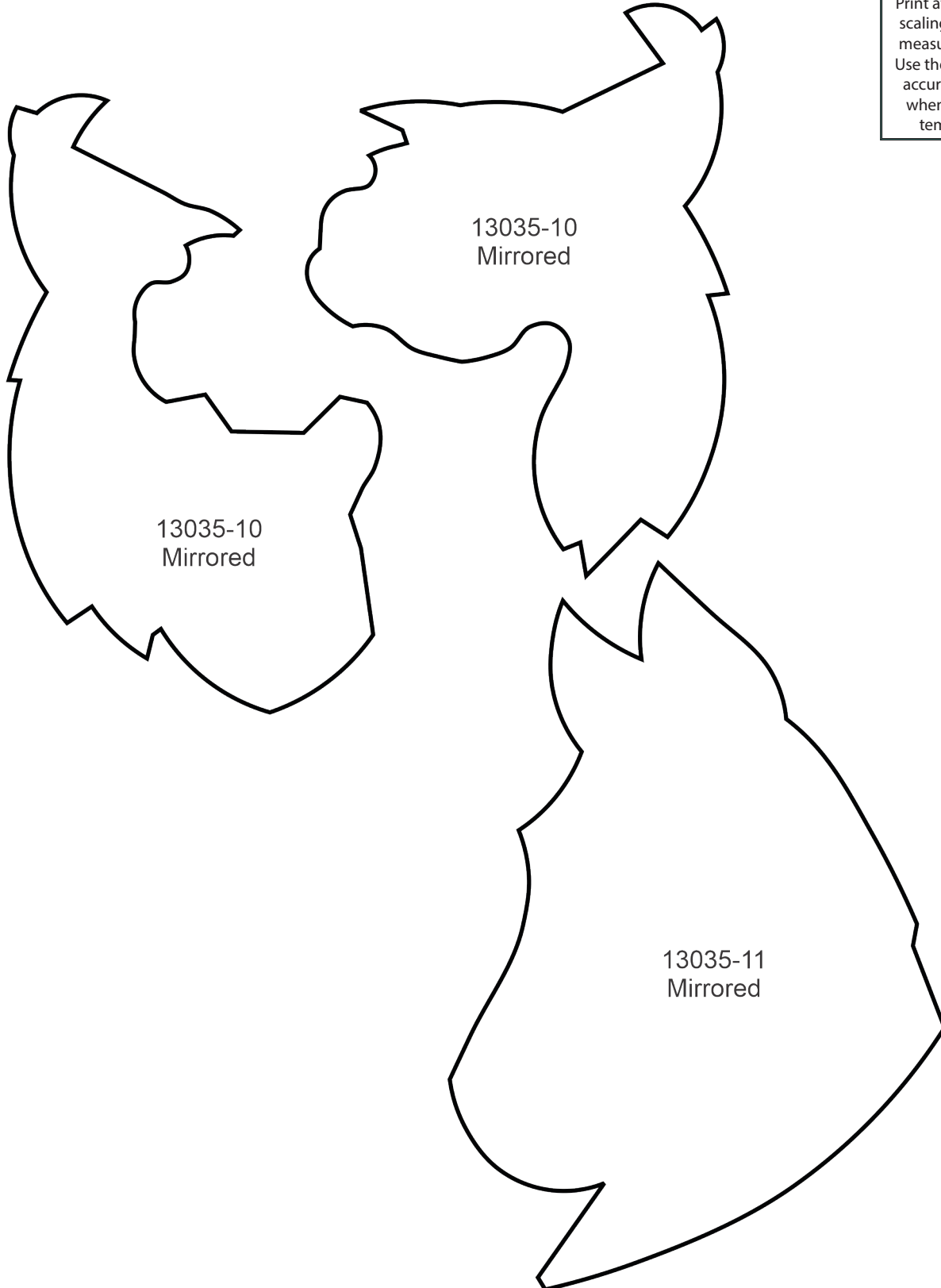

MIRRORED PATTERNS



Print at 100%. No scaling. This box measures 1" x 1". Use the box as an accuracy guide when printing templates.



MIRRORED PATTERNS



Print at 100%. No scaling. This box measures 1" x 1". Use the box as an accuracy guide when printing templates.

