

#12512

- 14 applique designs
- 1 freestanding lace design
- Project instructions included



1
DESIGNS

Freestanding Gingerbread House

THREAD LIST



Isacord Thread Colors

- 0015 White
- 1061 Taupe
- 3040 Lavender
- 4430 Island Waters
- 2220 Tropicana
- 5912 Erin Green
- 1900 Geranium
- 5613 Light Kelly

DESIGNS



Note: Some designs in this collection may have been created using unique special stitches and/or techniques. To preserve design integrity when rescaling or rotating designs in your software, always rescale or rotate designs using the handles directly on-screen.

*Fabric Required



12512-01 Front Wall FSA

Size Inches: Size mm: Stitch Count:
 4.92 X 6.47 in. 124.97 X 164.34 mm 37,419 St.

- 1. Wall Placement Stitch 0015
- 2. Window Cut Outs, Wall Cut Line & Tackdown..... 0015
- 3. Door Placement Stitch 0015
- 4. Wreath Cut Out, Door Cut Line & Tackdown..... 0015
- 5. Tan Linework 1061
- 6. Purple Candy 3040
- 7. Blue Candy..... 4430
- 8. Pink Candy..... 2220
- 9. Green Candy..... 5912
- 10. White Lace & Detail..... 0015
- 11. Dark Green Candy Stripes 5613
- 12. Green Door & Window Trim 5912
- 13. Pink Candy Stripes..... 2220
- 14. Red Candy Stripes & Window Trim..... 1900
- 15. White Cover Stitch & Detail..... 0015

Note: Some designs in this collection may have been created using unique special stitches and/or techniques. To preserve design integrity when rescaling or rotating designs in your software, always rescale or rotate designs using the handles directly on-screen.

***Fabric Required**



12512-02 Back Wall FSA

Size Inches: 4.92 X 6.47 in. Size mm: 124.97 X 164.34 mm Stitch Count: 36,056 St.

- 1. Wall Placement Stitch 0015
- 2. Window Cut Out, Wall Cut Line & Tackdown 0015
- 3. Green Candy Placement Stitch 5613
- 4. Green Candy Cut Line & Tackdown 5613
- 5. Green Candy Stripes..... 5613
- 6. Green Candy Cover Stitch & Stripes..... 5912
- 7. Tan Linework 1061
- 8. White Lace & Detail..... 0015
- 9. Blue Candy..... 4430
- 10. Light Green Candy & Window Trim..... 5912
- 11. Pink Candy & Stripes 2220
- 12. Red Candy, Stripes & Window Trim 1900
- 13. Purple Candy & Stripes..... 3040
- 14. White Cover Stitch & Detail..... 0015

***Fabric Required**



12512-03 Right Wall FSA

Size Inches: 5.47 X 4.45 in. Size mm: 138.94 X 113.03 mm Stitch Count: 30,422 St.

- 1. Right Wall Placement Stitch 0015
- 2. Window Cut Outs, Right Wall Cut Line & Tackdown..... 0015
- 3. White Lace 0015
- 4. Tan Linework..... 1061
- 5. Light Green Candy & Window Trim..... 5912
- 6. Purple Candy 3040
- 7. Blue Candy..... 4430
- 8. Pink Candy & Stripes 2220
- 9. Red Candy, Stripes & Window Trim 1900
- 10. White Cover Stitch & Detail..... 0015

Note: Some designs in this collection may have been created using unique special stitches and/or techniques. To preserve design integrity when rescaling or rotating designs in your software, always rescale or rotate designs using the handles directly on-screen.

***Fabric Required**

12512-04 Left Wall FSA

Size Inches: Size mm: Stitch Count:
 5.47 X 4.45 in. 138.94 X 113.03 mm 30,231 St.



- 1. Left Wall Placement Stitch 0015
- 2. Window Cut Out, Left Wall Cut Line & Tackdown .. 0015
- 3. Tan Linework 1061
- 4. Red Candy Placement Stitch 0015
- 5. Red Candy Cut Line & Tackdown 0015
- 6. Red Candy Stripes 1900
- 7. Red Candy Cover Stitch & Stripes 2220
- 8. White Lace & Detail..... 0015
- 9. Green Candy & Window Trim..... 5912
- 10. Purple Candy 3040
- 11. Blue Candy..... 4430
- 12. Pink Candy & Stripes 2220
- 13. Red Candy & Stripes..... 1900
- 14. White Cover Stitch & Detail..... 0015

***Fabric Required**

12512-05 Right Roof FSA

Size Inches: Size mm: Stitch Count:
 6.58 X 4.34 in. 167.13 X 110.24 mm 40,088 St.

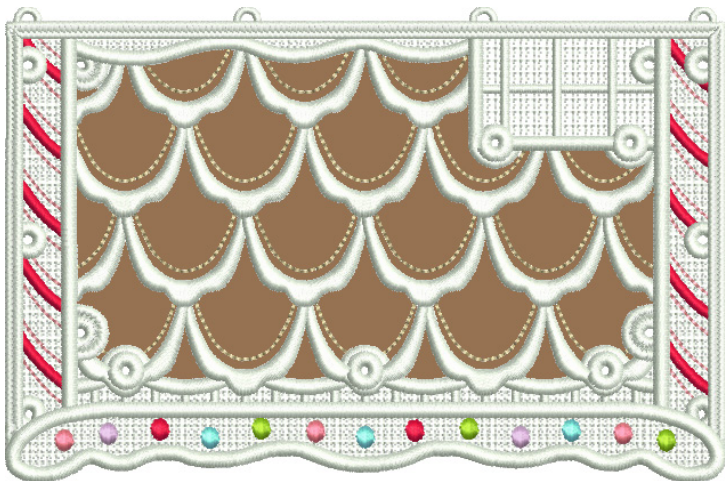

- 1. Right Roof Placement Stitch 0015
- 2. Right Roof Cut Line & Tackdown 0015
- 3. Tan Linework 1061
- 4. White Lace 0015
- 5. Pink Candy & Stripes 2220
- 6. Red Candy & Stripes..... 1900
- 7. Green Candy..... 5912
- 8. Purple Candy 3040
- 9. Blue Candy..... 4430
- 10. White Cover Stitch & Detail..... 0015

Note: Some designs in this collection may have been created using unique special stitches and/or techniques. To preserve design integrity when rescaling or rotating designs in your software, always rescale or rotate designs using the handles directly on-screen.

***Fabric Required**

12512-06 Left Roof FSA

Size Inches: Size mm: Stitch Count:
 6.58 X 4.42 in. 167.13 X 112.27 mm 40,266 St.

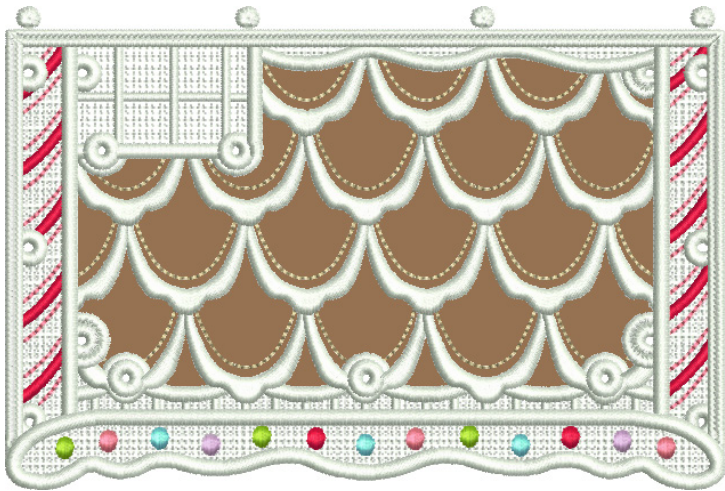

- 1. Left Roof Placement Stitch..... 0015
- 2. Left Roof Cut Line & Tackdown..... 0015
- 3. Tan Linework..... 1061
- 4. White Lace..... 0015
- 5. Pink Candy & Stripes..... 2220
- 6. Red Candy & Stripes..... 1900
- 7. Green Candy..... 5912
- 8. Purple Candy..... 3040
- 9. Blue Candy..... 4430
- 10. White Cover Stitch & Detail..... 0015

***Fabric Required**

12512-07 Chimney FSA

Size Inches: Size mm: Stitch Count:
 1.84 X 6.81 in. 46.74 X 172.97 mm 15,670 St.

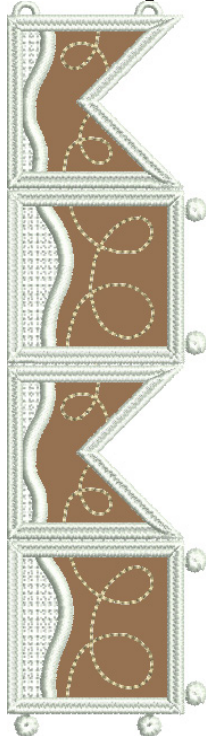

- 1. Chimney Placement Stitch..... 0015
- 2. Chimney Cut Lines & Tackdown..... 0015
- 3. Tan Linework..... 1061
- 4. White Cover Stitch & Detail..... 0015

Note: Some designs in this collection may have been created using unique special stitches and/or techniques. To preserve design integrity when rescaling or rotating designs in your software, always rescale or rotate designs using the handles directly on-screen.

***Fabric Required**

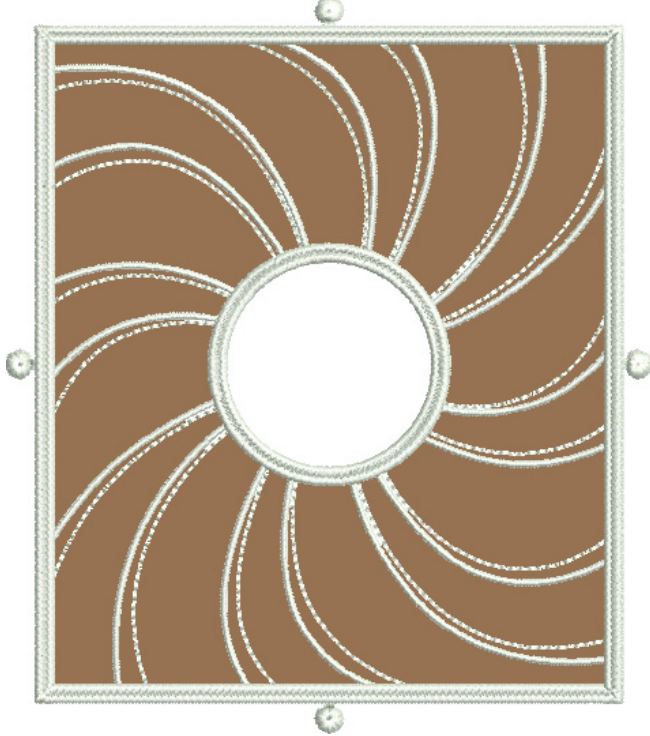

12512-08 Floor FSA

Size Inches: Size mm: Stitch Count:
 4.95 X 5.64 in. 125.73 X 143.26 mm 15,672 St.

- 1. Floor Placement Stitch0015
- 2. Candle Cut Out , Floor Cut Line & Tackdown0015
- 3. White Cover Stitch & Detail.....0015

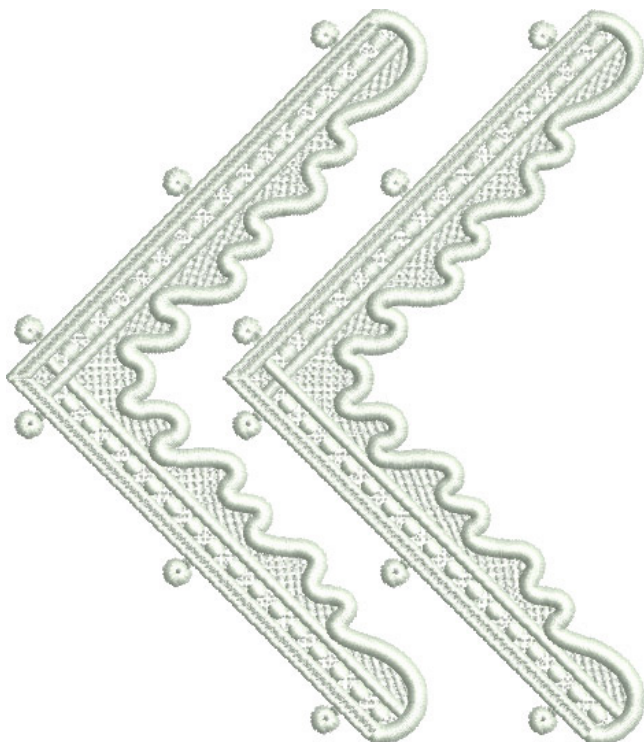

12512-09 Icicles FSL

Size Inches: Size mm: Stitch Count:
 4.87 X 5.61 in. 123.70 X 142.49 mm 27,553 St.

- 1. Single Color Design0015

Note: Some designs in this collection may have been created using unique special stitches and/or techniques. To preserve design integrity when rescaling or rotating designs in your software, always rescale or rotate designs using the handles directly on-screen.

***Fabric Required**

12512-10 Wreath FSA

Size Inches: Size mm: Stitch Count:
 1.41 X 1.41 in. 35.81 X 35.81 mm 2,412 St.



- 1. Wreath Placement Stitch..... 5912
- 2. Center Cut Out, Wreath Cut Line & Tackdown..... 5912
- 3. Cover Stitch..... 5912
- 4. Bow 2220
- 5. Berries..... 1900
- 6. White Linework..... 0015

***Fabric Required**

12512-11 Mini Candies FSA

Size Inches: Size mm: Stitch Count:
 .91 X 4.86 in. 23.11 X 123.44 mm 4,367 St.



- 1. Candy Placement Stitches 0015
- 2. Candy Cut Lines & Tackdown 0015
- 3. Top Candy Pink Swirls 2220
- 4. Top Candy Cover Stitch 0015
- 5. Top Candy Red Swirls..... 1900
- 6. Middle Candy Purple Swirls 3040
- 7. Middle Candy Cover Stitch..... 0015
- 8. Middle Candy Green Swirls..... 5912
- 9. Bottom Candy Green Swirls..... 5912
- 10. Bottom Candy Cover Stitch..... 0015
- 11. Bottom Candy Blue Swirls..... 4430

Note: Some designs in this collection may have been created using unique special stitches and/or techniques. To preserve design integrity when rescaling or rotating designs in your software, always rescale or rotate designs using the handles directly on-screen.

***Fabric Required**



12512-12 Mini Buttons FSA

Size Inches: Size mm: Stitch Count:
 1.03 X 3.23 in. 26.16 X 82.04 mm 2,574 St.

- 1. Button Placement Stitch..... 0015
- 2. Button Cut Lines & Tackdown 0015
- 3. Top Button Cover Stitch & Linework..... 5912
- 4. Top Button White Linework 0015
- 5. Bottom Button Cover Stitch & Linework..... 2220
- 6. Bottom Button White Linework..... 0015



***Fabric Required**

12512-13 Candy Heart FSA

Size Inches: Size mm: Stitch Count:
 1.29 X 1.27 in. 32.77 X 32.26 mm 2,055 St.

- 1. Heart Placement Stitch 1900
- 2. Heart Cut Line & Tackdown..... 1900
- 3. Pink Cover Stitch & Linework..... 2220
- 4. White Swirls & Linework..... 0015



Note: Some designs in this collection may have been created using unique special stitches and/or techniques. To preserve design integrity when rescaling or rotating designs in your software, always rescale or rotate designs using the handles directly on-screen.

***Fabric Required**

12512-14 Button FSA

Size Inches:	Size mm:	Stitch Count:
1.28 X 1.28 in.	32.51 X 32.51 mm	1,590 St.



- 1. Button Placement Stitch.....2220
- 2. Button Cut Line & Tackdown2220
- 3. Pink Cover Stitch & Linework.....2220
- 4. White Linework.....0015

***Fabric Required**

12512-15 Candy FSA

Size Inches:	Size mm:	Stitch Count:
1.28 X 1.28 in.	32.51 X 32.51 mm	2,043 St.



- 1. Candy Placement Stitch.....2220
- 2. Candy Cut Line & Tackdown2220
- 3. Pink Cover Stitch & Stripes2220
- 4. Red Stripes1900

EMBROIDERY



STEP 1

- The same technique will be used for 12512-02 and 12512-04.
- Prep fabric by applying 2 sheets of StabilStick TearAway to the wrong side of the fabric.
- **Note** - this stabilizes your fabric so it isn't too limp and produces a nice, crisp project.



STEP 2

- Hoop two sheets of AquaMesh.
- Stitch Wall Placement Stitch.
- **Note** - we've stitched our placement stitch in brown for visibility

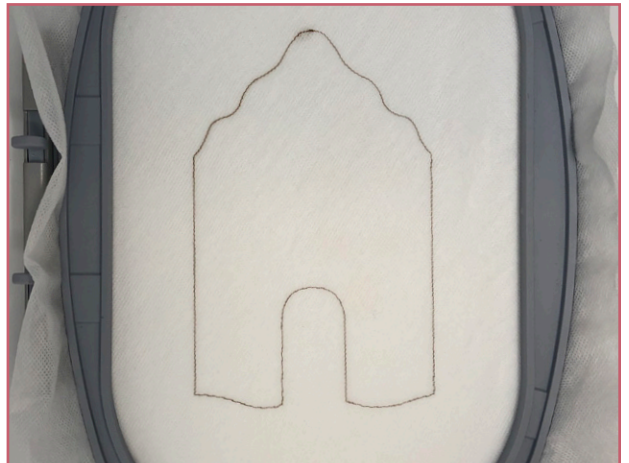

STEP 3

- Place fabric over placement stitch and make sure to cover stitches completely.
- Stitch Window Cut Outs, Wall Cut Line & Tackdown.
- **Optional** - use TearAway tape to hold items in place.

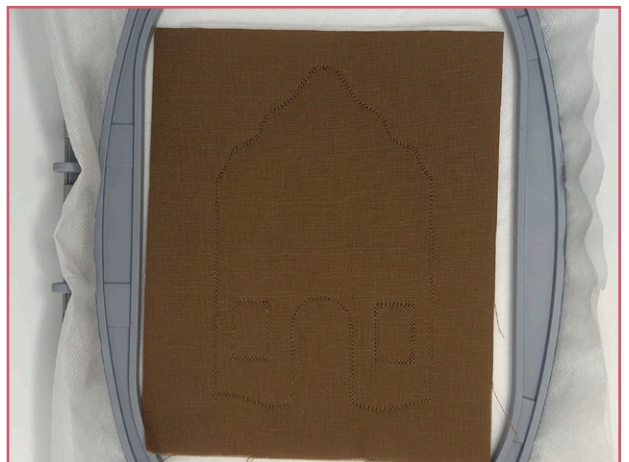

EMBROIDERY



STEP 4

- If tape was used, remove tape, carefully.
- Remove hoop from machine, **DO NOT** unhoop fabric/stabilizer.
- Trim along cut line.



STEP 5

- Stitch Door Placement Stitch.
- Place fabric over door as pictured, make sure to cover door opening completely.
- Stitch Wreath Cut Out, Door Cut Line & Tackdown.
- **Optional** - use TearAway tape to hold items in place.



STEP 6

- If tape was used, remove tape, carefully.
- Remove hoop from machine, **DO NOT** unhoop fabric/stabilizer.
- Trim along cut line.



EMBROIDERY



STEP 7

- Stitch Tan Linework.



STEP 8

- Stitch Purple Candy.



STEP 9

- Stitch Blue Candy.



EMBROIDERY



STEP 10

- Stitch Pink Candy.



STEP 11

- Stitch Green Candy.



STEP 12

- Stitch White Lace & Detail.



EMBROIDERY



STEP 13

- Stitch Dark Green Candy Stripes.



STEP 14

- Stitch Green Door & Window Trim.



STEP 15

- Stitch Pink Candy Stripes.



EMBROIDERY



STEP 16

- Stitch Red Candy Stripes & Window Stripes.



STEP 17

- Stitch White Cover Stitch & Detail.



STEP 18

- Remove from hoop, trim AquaMesh $\frac{1}{4}$ "- $\frac{1}{2}$ " away from fabric, be careful **NOT** to cut your eyelets or buttonettes!
- Wash away stabilizer and let dry.
- **Note** - for instructions and tips, see last page.



EMBROIDERY



STEP 1

- The same technique will be used for 12512-03, 12512-05, 12512-06, 12512-07, 12512-10, 12512-11, 12512-12, 12512-13, 12512-14, and 12512-15.
- Prep fabric by applying 2 sheets of StabilStick TearAway to the wrong side of the fabric.
- **Note** - this stabilizes your fabric so it isn't too limp and produces a nice, crisp project.



STEP 2

- Hoop two sheets of AquaMesh.
- Stitch Floor Placement Stitch.

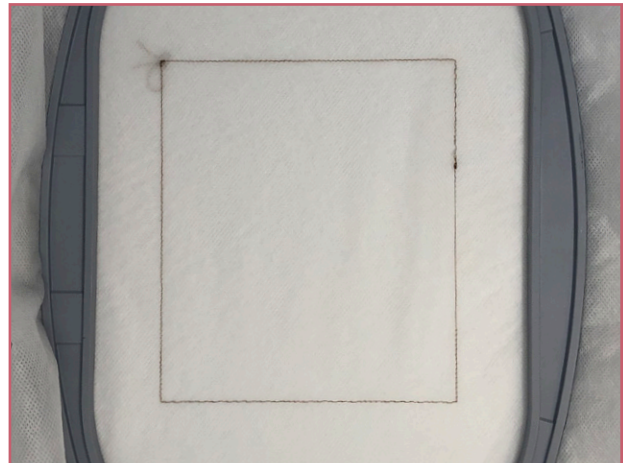

STEP 3

- Place fabric over placement stitch and make sure to cover stitches completely.
- Stitch Candle Cutout, Floor Cut Line & Tackdown.
- **Optional** - use TearAway tape to hold items in place.

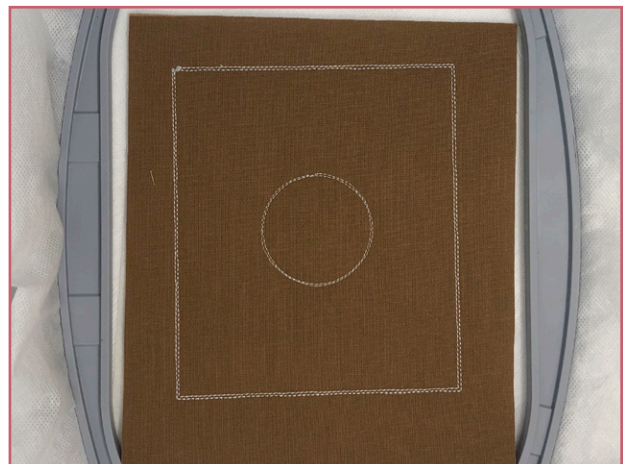

EMBROIDERY



STEP 4

- Remove tape, carefully.
- Remove hoop from machine, **DO NOT** unhoop fabric/stabilizer.
- Trim along cut line.



STEP 5

- Stitch White Cover Stitch & Detail.



STEP 6

- Remove from hoop, trim AquaMesh $\frac{1}{4}$ "- $\frac{1}{2}$ " away from fabric, be careful **NOT** to cut your eyelets or buttonettes!
- Wash away stabilizer and let dry.
- **Note** - for instructions and tips, see last page.

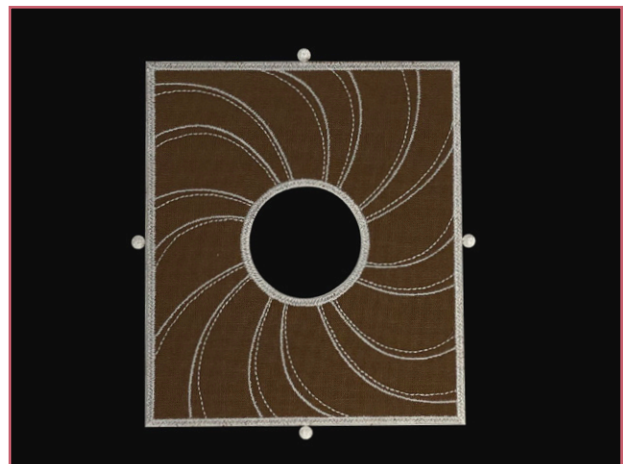

EMBROIDERY



STEP 1

- For freestanding lace instructions and tips, see last page.



INSTRUCTIONS



Freestanding Gingerbread House - Summary Requires

- Front Wall FSA - 12512-01
- Back Wall FSA - 12512-02
- Right Wall FSA - 12512-03
- Left Wall FSA - 12512-04
- Right Roof FSA - 12512-05
- Left Roof FSA - 12512-06
- Chimney FSA - 12512-07
- Floor FSA - 12512-08
- Icicles FSL - 12512-09

Optional

- Wreath FSA – 12512-10
- Mini Candies FSA – 12512-11
- Mini Buttons FSA – 12512-12
- Candy Heart FSA – 12512-13
- Button FSA – 12512-14
- Candy FSA – 12512-15

Supplies

- Embroidery thread
- Fabric for appliqué
- Embroidery machine
- Stabilizer
- *Optional* - Alligator Clamps and Button Clips



Follow the *General Freestanding Lace Guidelines* and *Cut in Place Appliqué Instructions* and stitch the nine pieces required as listed in the summary above.

Adding *Optional* FSA Pieces

- Glue or stitch on the *Optional* FSA pieces as desired. **Photo 1**

Build Gingerbread House Walls

- Attach the front wall (12512-01) to the right wall (12512-03) by inserting the three buttonettes along the right side of the front wall into the three eyelets on the left side of the right wall. **Photo 2**
- Repeat this process with the back wall (12512-02) and left wall (12512-04), until the wall structure is complete.
- Set aside assembled Gingerbread House wall structure.

Build Gingerbread House Roof and Chimney and Attach to Walls

- Connect right roof (12512-05) and left roof (12512-06) together by inserting buttonettes from the left side of one piece into the eyelets from the right side of the other piece.
- Attach the constructed roof to the gingerbread wall structure by inserting the buttonettes along the top of each wall section into the coordinating eyelets located toward the bottom of each roof piece. The buttonettes will be pulled up through the roof pieces. The chimney will be towards the back of the gingerbread house. **Photo 3**
- Connect the two buttonettes into the eyelets to form the chimney (12512-07). Attach the constructed roof to the gingerbread wall structure by inserting the three buttonettes along the top edge of the right wall section into the three



INSTRUCTIONS



- eyelets located near the bottom edge of the right roof section. The buttonettes will be pulled up through the roof slices. The chimney should be at the back of the house.
- Attach the chimney to the back of the gingerbread house roof by inserting the four buttonettes along the bottom of the chimney into the coordinating eyelets located on either side of the back of the roof structure. **NOTE:** It is easier to reach in from the inside with a pair of alligator clamps and pull the buttonettes through the eyelets. **Photo 4**



Attach Gingerbread House Floor to Walls

- Connect the floor (12512-08) to all walls by inserting the floor buttonettes through the centered eyelets. **Photo 5**

Attach Icicles to Gingerbread House

- Attach the Icicles (12512-09) to the Front and Back roof overhang by inserting the buttonettes along the icicles into the coordinating eyelets located on the edge of the roof. The buttonettes will be pulled up through the roof pieces. **Photo 6**



Your Freestanding Gingerbread House is complete!

INSTRUCTIONS



Cut in Place Appliqué Instructions

1. Hoop your fabric and backing.
2. Sew the *Placement* stitch. **PHOTO 1**
3. Place a piece of applique fabric over the placement stitch so that it is completely covered.
4. Sew the *Cut Line & Tackdown*.
5. Carefully cut away the excess applique fabric. **PHOTO 2**
6. Sew the remainder of the design and repeat for any remaining pieces. **PHOTO 3**

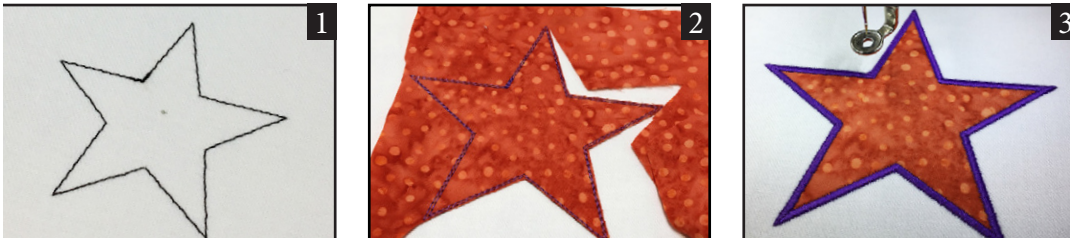

General Freestanding Lace Guidelines

Supplies:

Embroidery Thread:

- Use the same embroidery thread in the bobbin as the needle.

Needles:

- Use an Organ 80/12 Titanium needle for extended needle life.

Stabilizer:

- Use OESD AquaMesh stabilizer.

Handy Hints:

For Stiffer Lace:

- DO NOT rinse away all of the stabilizer for a “stiffer” lace. Note that the thread may appear a shade darker if stabilizer is not removed completely.
- If you happen to wash too much out, easily re-stiffen by diluting some stabilizer scraps in water and dipping the item in the solution.

For Very Soft Lace:

- Cut away excess stabilizer. Remove remaining stabilizer by rinsing under warm running water until all traces of the stabilizer are gone. **NOTE:** If lace should become too limp to work with, dissolve stabilizer scraps in warm water and apply to the lace.

Drying Lace:

- The lace looks best when left to dry completely. Lay lace piece with right side down to dry. This will minimize the tendency for the lace to curl. Be sure to flatten the piece out entirely and allow ample time to dry.

General Instructions

1. Hoop two layers of OESD AquaMesh Stabilizer.
2. Attach the hoop to the machine and select the design of your choice.
3. Stitch the design.
4. Remove the hoop from the machine and the design from the hoop. Trim excess stabilizer from the design.
5. Rinse away remaining stabilizer and allow it to dry.

Handy Hints:

For 3D Lace Projects:

- If item becomes too limp to work with, iron the lace pieces on the wrong side while applying spray starch. After ironing, spray again with starch and allow to dry completely. This will stiffen the lace pieces nicely and aid in construction.
- A pair of tweezers, hemostats, stiletto or a tiny crochet hook can be extremely helpful when inserting the buttonettes into the eyelets. (Please see **Diagram 1** for explanation of “buttonette” and “eyelet”.)
- Insert the tip of the alligator clamps, tweezers, hemostats or crochet hook into the eyelet, grasp the buttonette and pull through the eyelet. Or a stiletto could be used to push the buttonette through the eyelet.

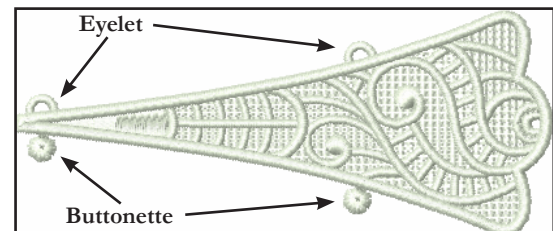
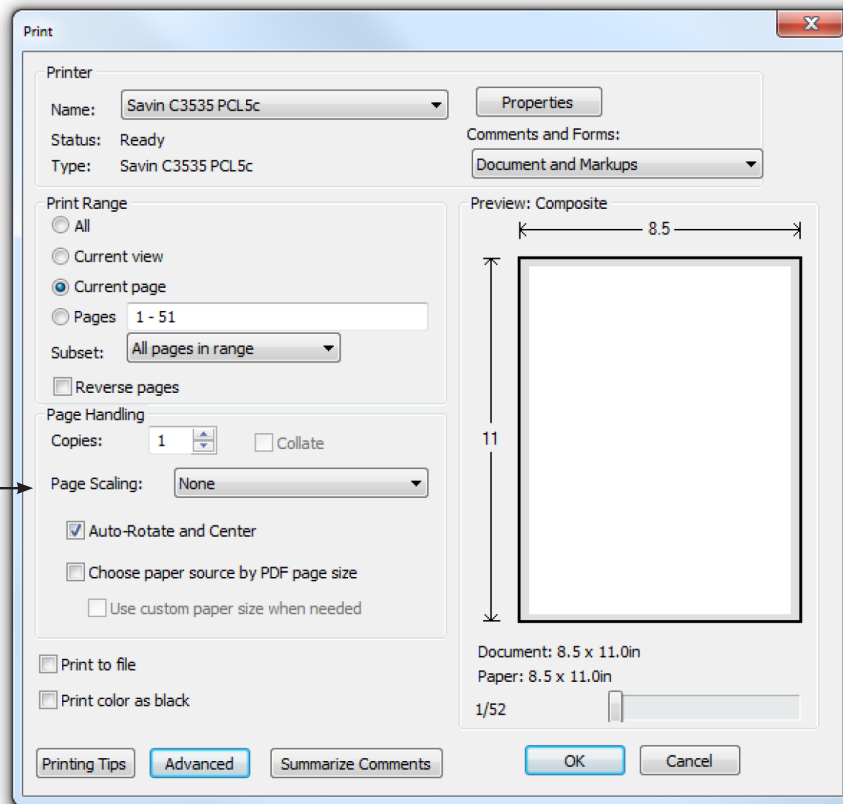

Diagram 1

ATTENTION

When printing this document, any page scaling or page fitting options in your print dialog box must be turned OFF or set to NONE so that your files will print out at their actual size. Images not printed at actual size will not function as intended.



TO SAVE PAPER

Only print the desired image by navigating to the image's page, go to File > Print and select "Current page" in the print dialog box. Repeat for each desired image.

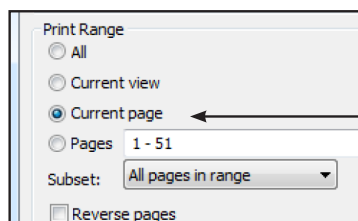

APPLIQUE PATTERNS



Print at 100%. No scaling. This box measures 1" x 1". Use the box as an accuracy guide when printing templates.

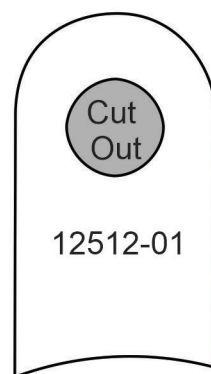
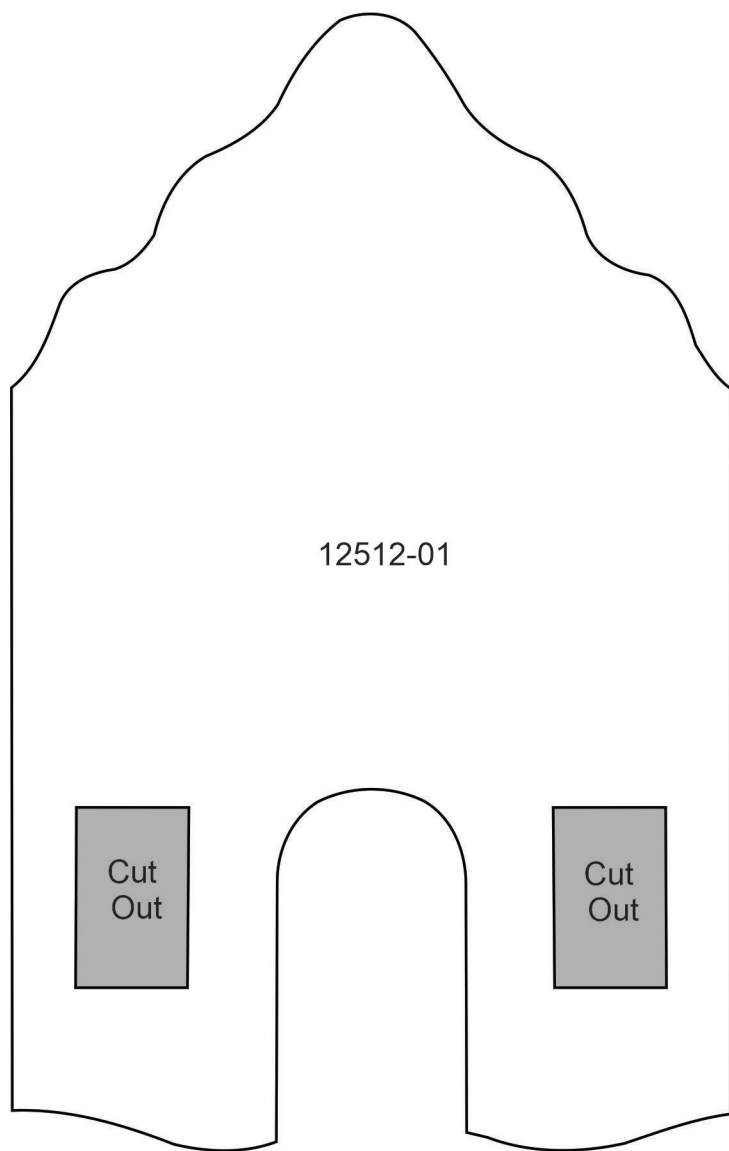

APPLIQUE PATTERNS



Print at 100%. No scaling. This box measures 1" x 1". Use the box as an accuracy guide when printing templates.

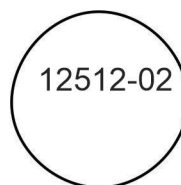
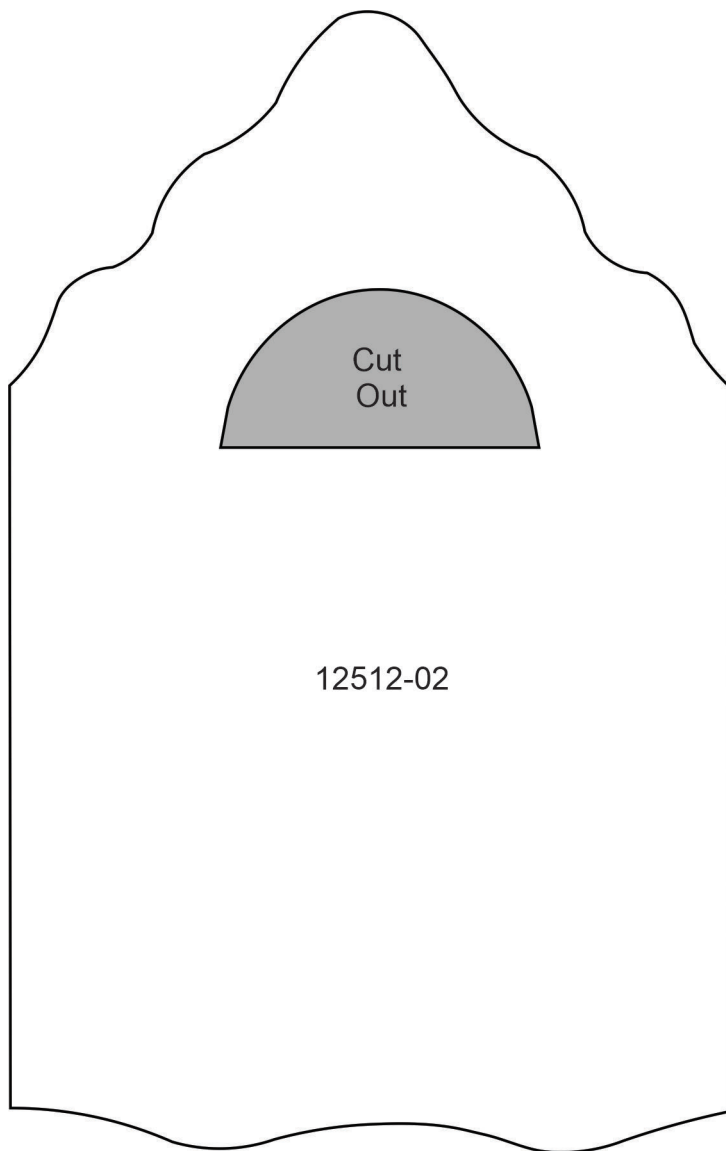

APPLIQUE PATTERNS



Print at 100%. No scaling. This box measures 1" x 1". Use the box as an accuracy guide when printing templates.

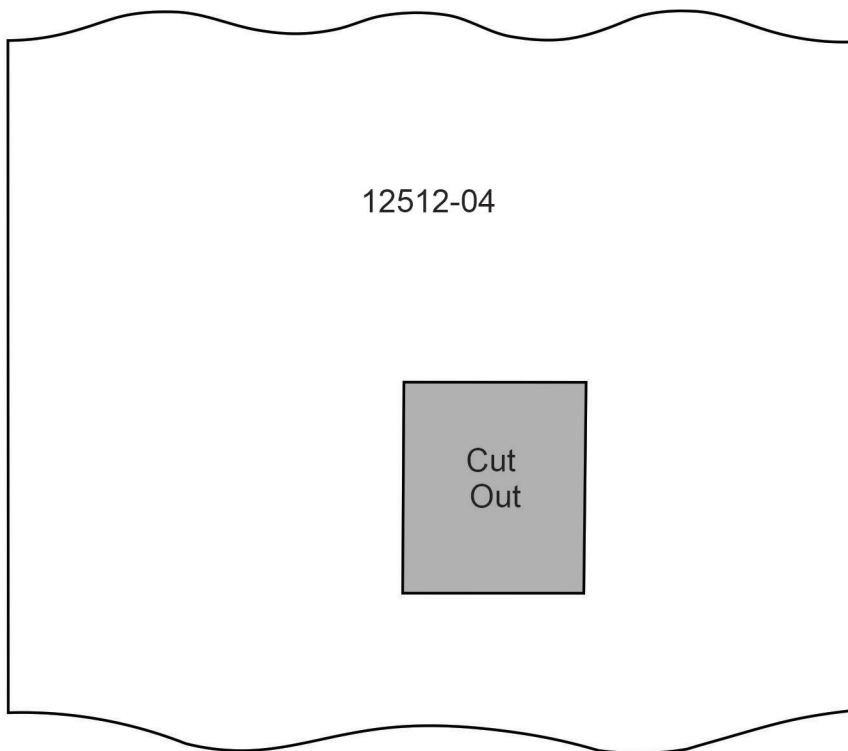
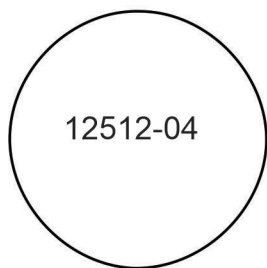
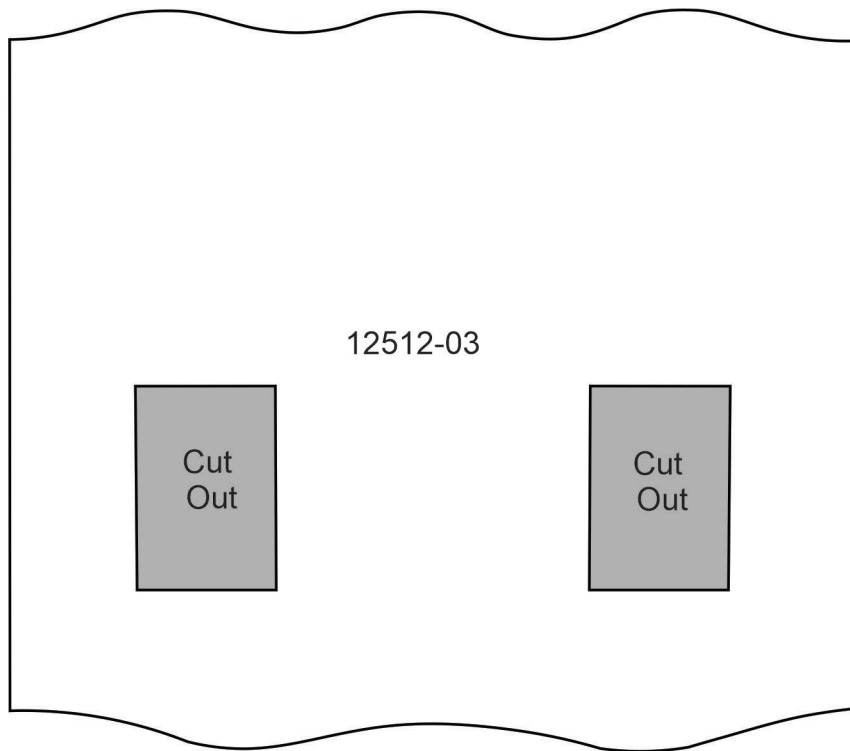

APPLIQUE PATTERNS



Print at 100%. No scaling. This box measures 1" x 1". Use the box as an accuracy guide when printing templates.

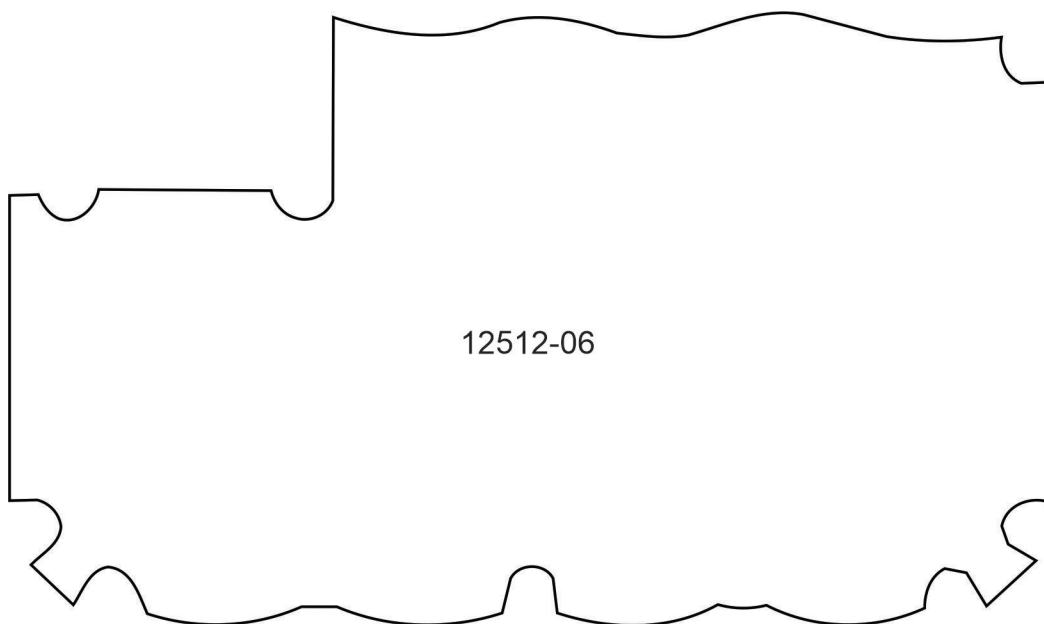
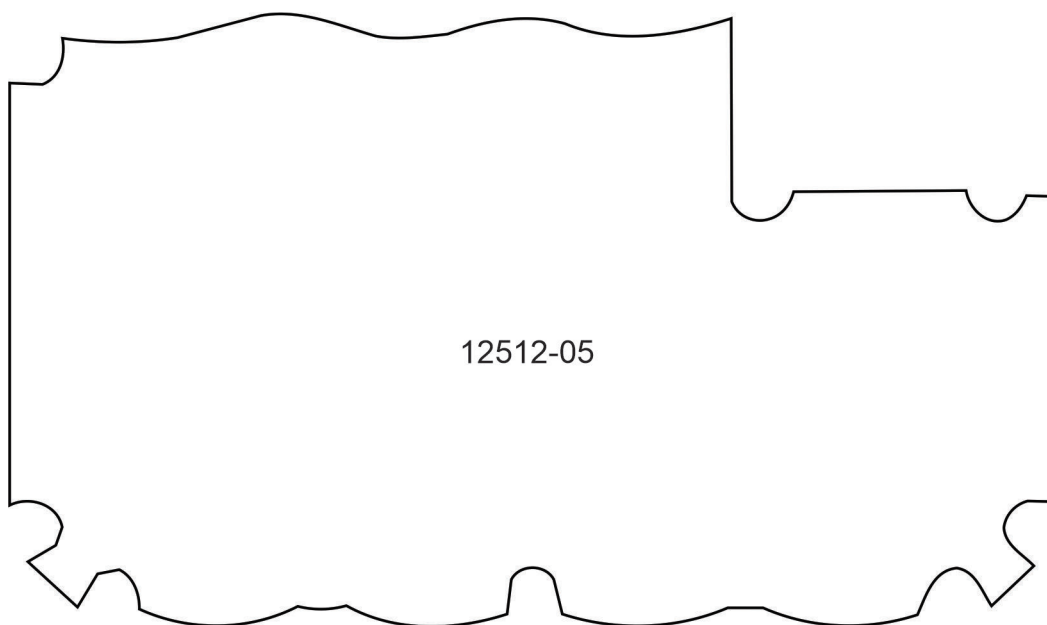

APPLIQUE PATTERNS



Print at 100%. No scaling. This box measures 1" x 1". Use the box as an accuracy guide when printing templates.

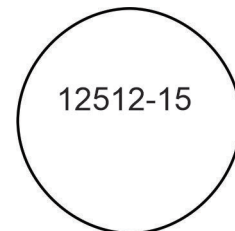
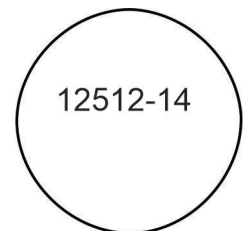
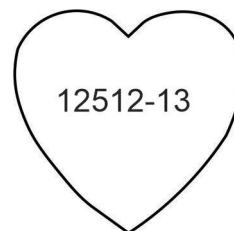
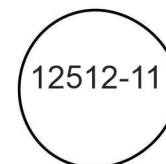
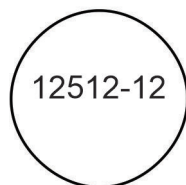
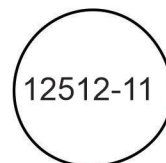
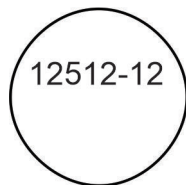
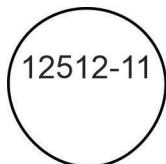
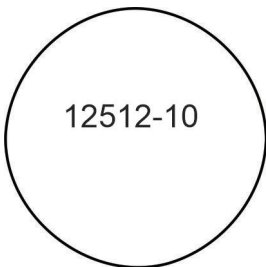
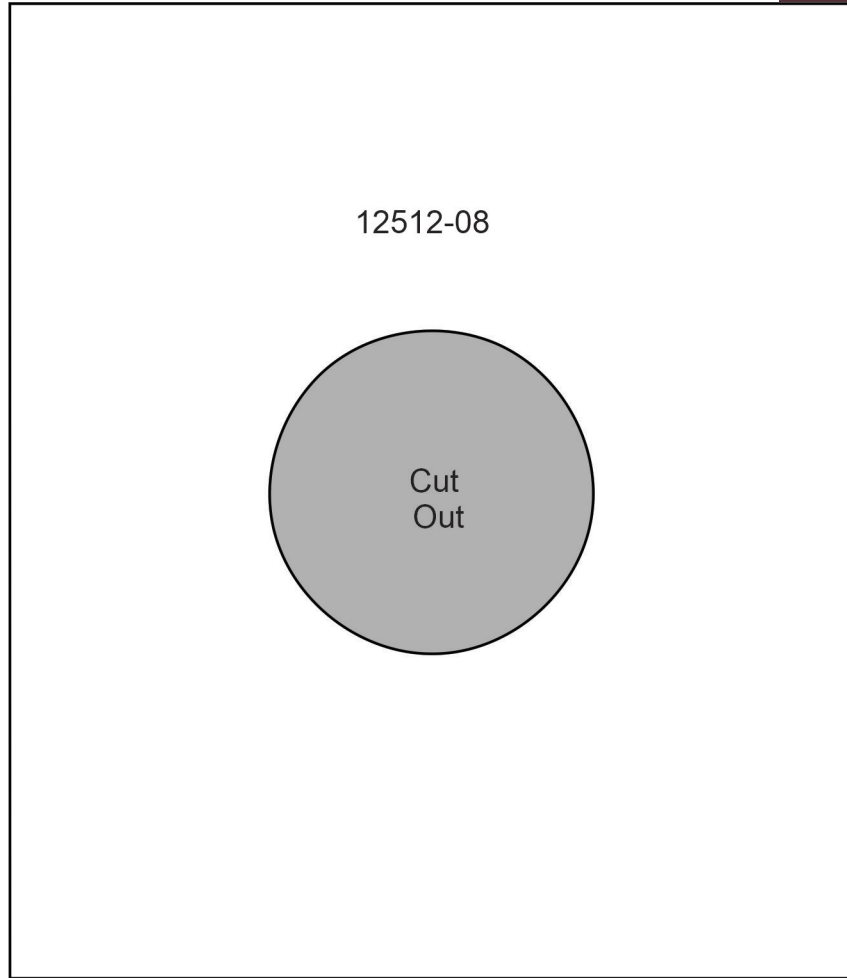
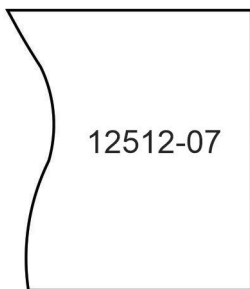
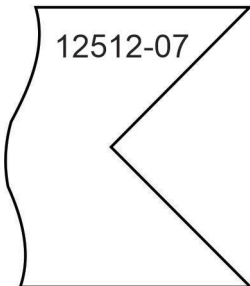
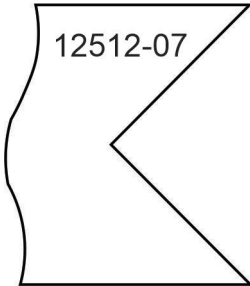

MIRRORED PATTERNS



Print at 100%. No scaling. This box measures 1" x 1". Use the box as an accuracy guide when printing templates.

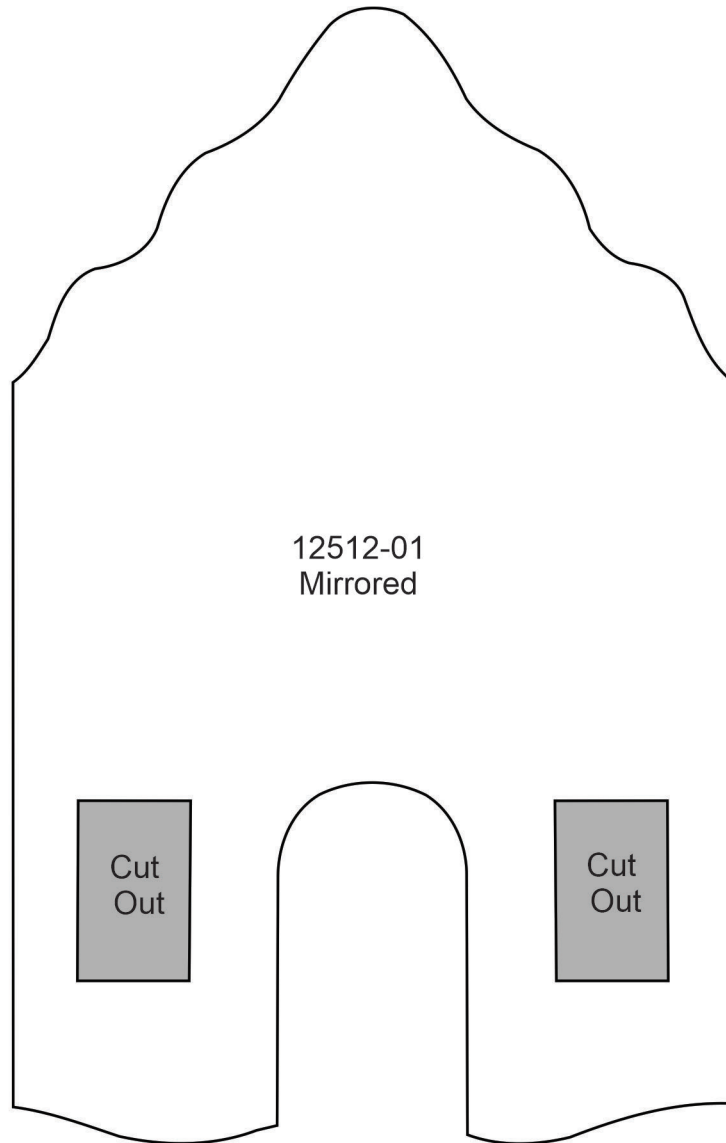
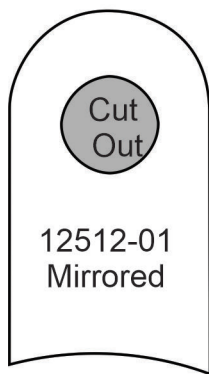

MIRRORED PATTERNS



Print at 100%. No scaling. This box measures 1" x 1". Use the box as an accuracy guide when printing templates.

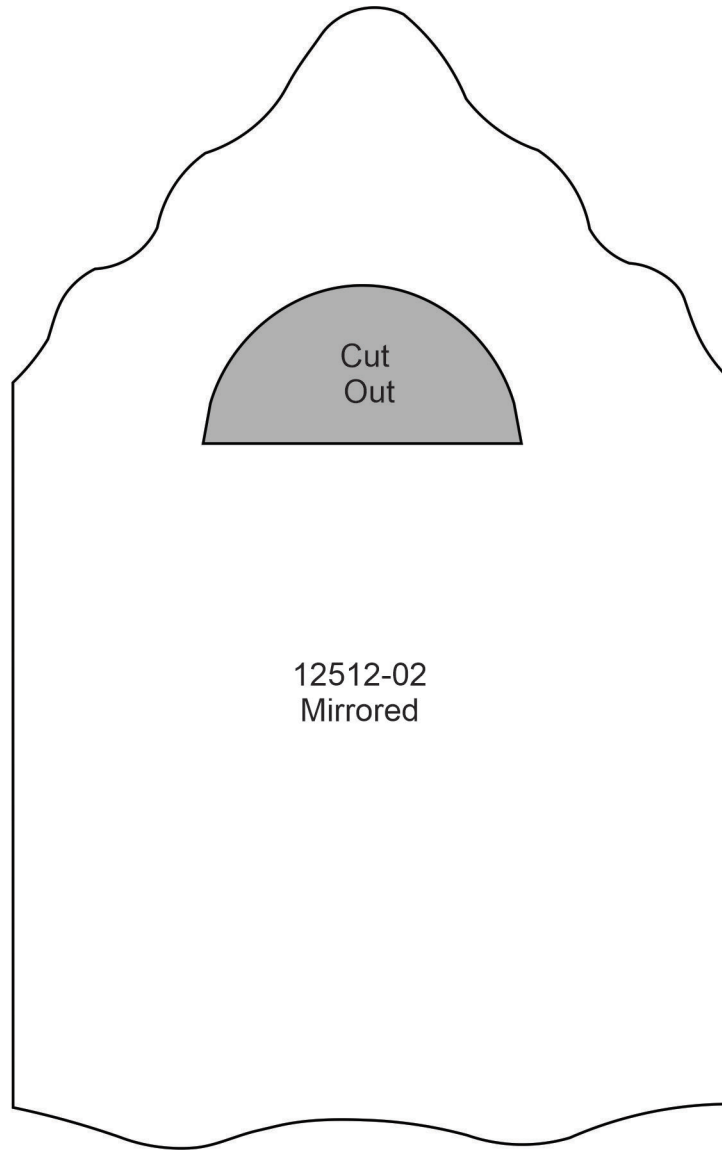

MIRRORED PATTERNS



Print at 100%. No scaling. This box measures 1" x 1". Use the box as an accuracy guide when printing templates.

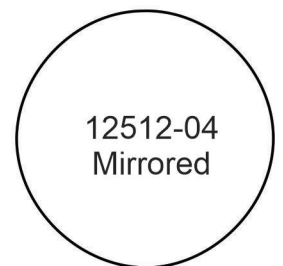
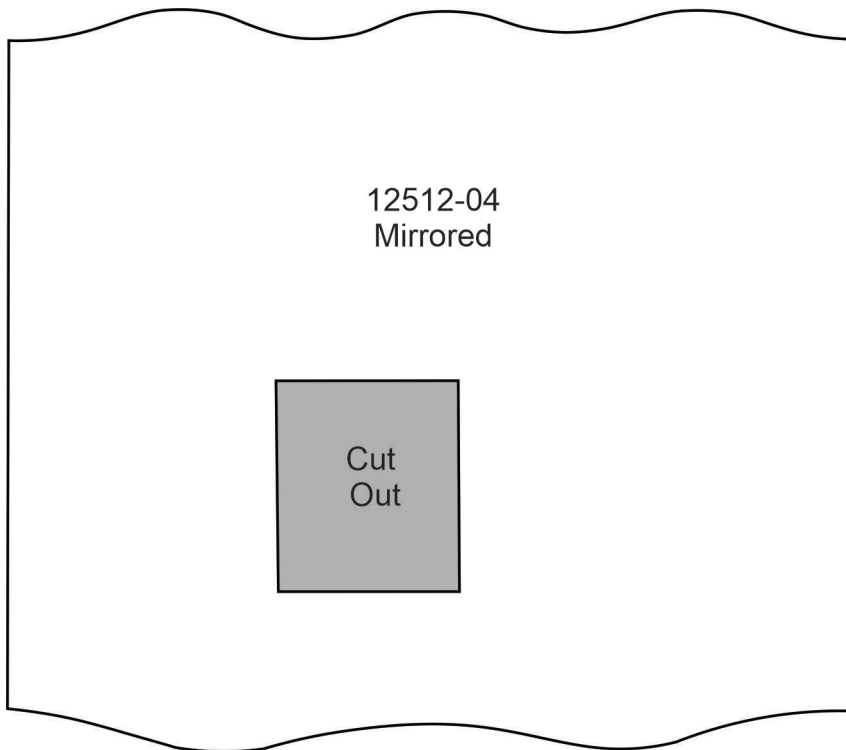
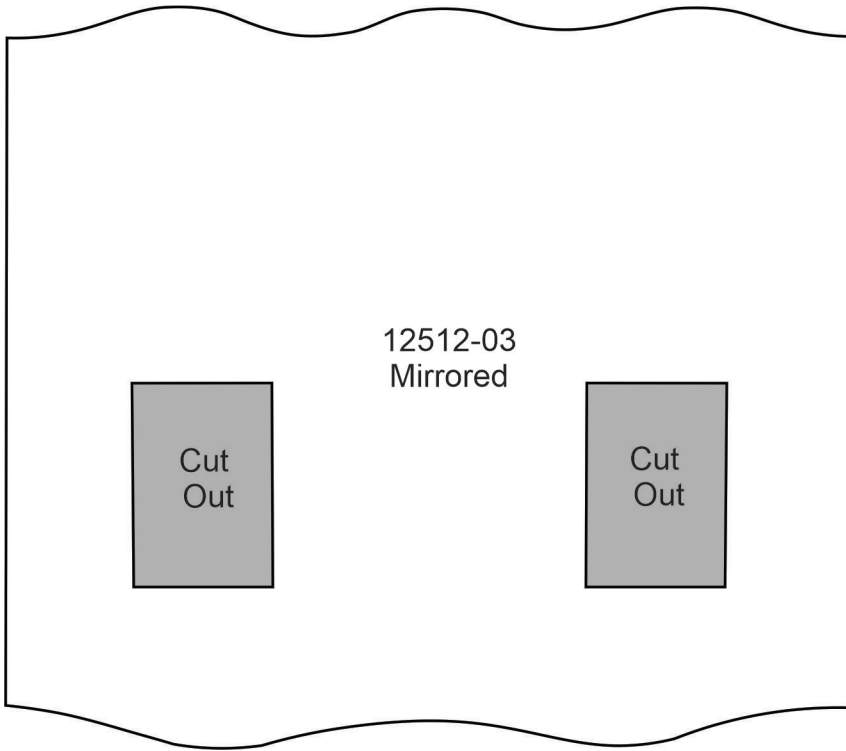

MIRRORED PATTERNS



Print at 100%. No scaling. This box measures 1" x 1". Use the box as an accuracy guide when printing templates.

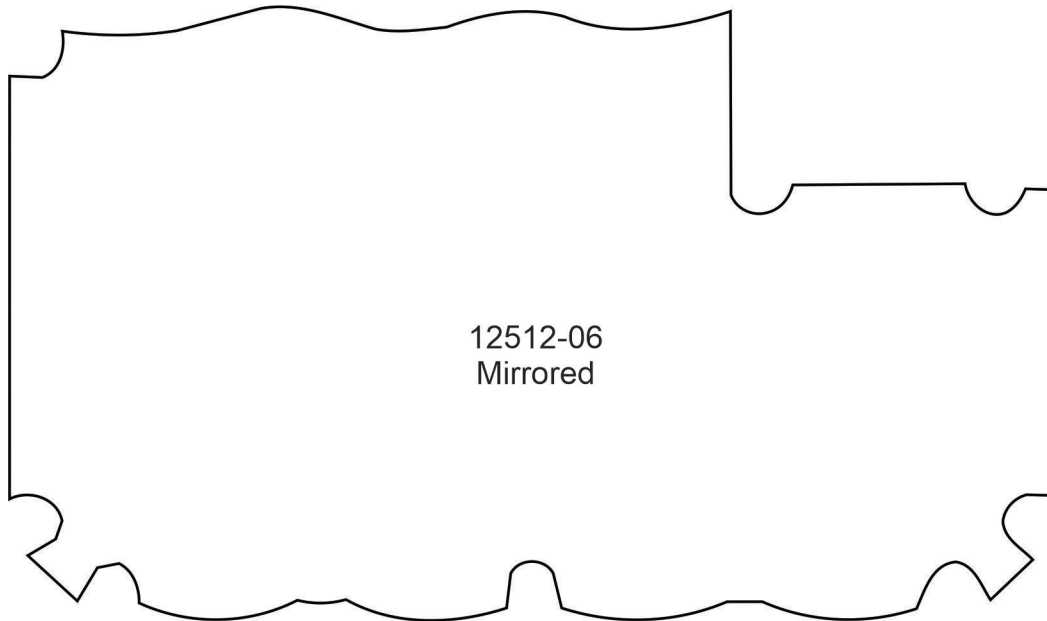
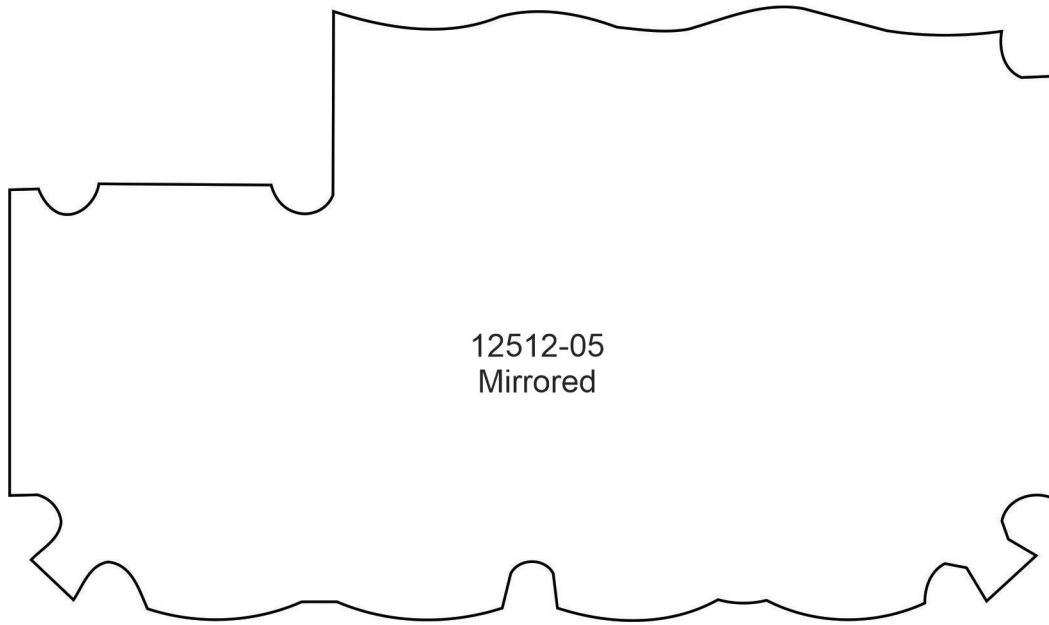

MIRRORED PATTERNS



Print at 100%. No scaling. This box measures 1" x 1". Use the box as an accuracy guide when printing templates.

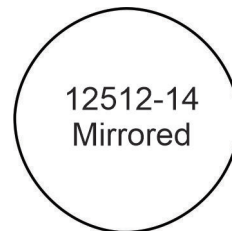
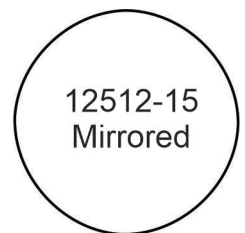
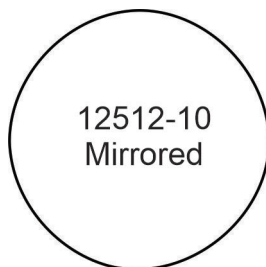
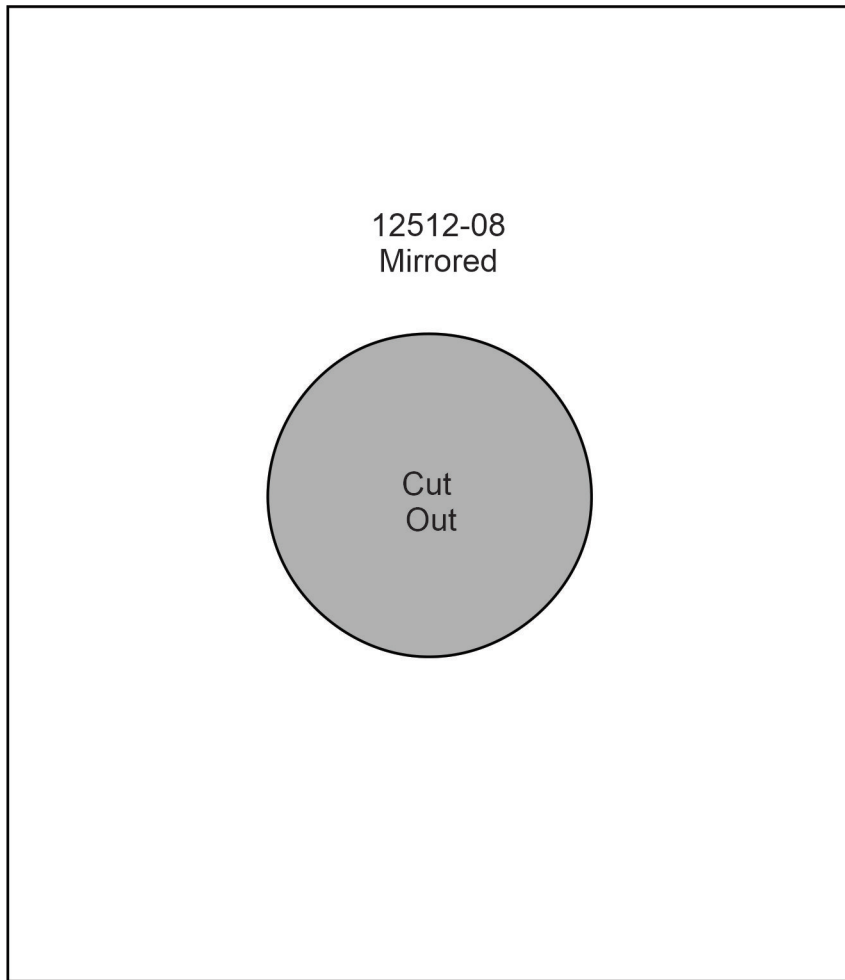
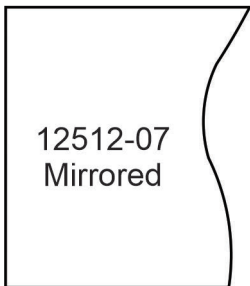
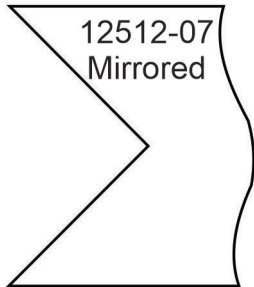
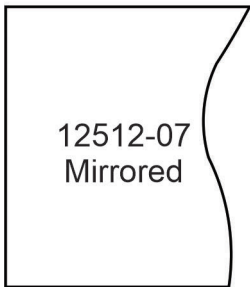
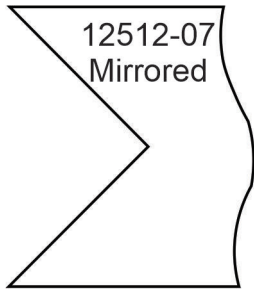



#51234
1 DESIGN



FREESTANDING SUGAR CHALET

It is a violation of Copyright law to make and distribute copies of electronic designs or artwork.
Electronic designs are licensed to the original purchaser for use at one location. ©2020 OESD, LLC. All rights reserved.

MATERIALS



Isacord Thread Colors

0015 White - 2 spools
0310 Yellow - 1 spool
1030 Passion Fruit - 1 spool
1141 Tan - 1 spool
1900 Geranium - 1 spool
2640 Frosted Plum - 1 spool
3030 Amethyst - 1 spool
5220 Silver Sage - 1 spool

DESIGNS



Note: Some designs in this collection may have been created using unique special stitches and/or techniques. To preserve design integrity when rescaling or rotating designs in your software, always rescale or rotate designs using the handles directly on-screen.

FABRIC REQUIRED



51234-01 Front Wall FSA

Size Inches: **6.91 X 5.43 in.** Size mm: **175.5 X 137.9 mm** Stitch Count: **24713 St.**

- 1. Brown Fabric Placement Stitch.....0015
- 2. Cut Line and Tackdown.....0015
- 3. Pink Fabric Placement Stitch.....0015
- 4. Cut Line and Tackdown.....0015
- 5. Window.....0015
- 6. Pink Stripes and Candy.....2640
- 7. Yellow Candy.....0310
- 8. Orange Detail.....1030
- 9. White Detail.....0015
- 10. Red Stripes/ Door and Window1900
- 11. Green Candy.....5220
- 12. Purple Candy3030
- 13. Tan Swirls1141
- 14. White Detail.....0015
- 15. Cover Stitch and Lace0015

FABRIC REQUIRED



51234-02 Back Wall FSA

Size Inches: **6.91 X 5.43 in.** Size mm: **175.5 X 137.9 mm** Stitch Count: **22550 St.**

- 1. Brown Fabric Placement Stitch.....0015
- 2. Cut Line and Tackdown.....0015
- 3. White Fabric Placement Stitch.....0015
- 4. Cut Line and Tackdown.....0015
- 5. Window.....0015
- 6. Red Detail1900
- 7. Pink Detail.....2640
- 8. Yellow Candy.....0310
- 9. Green Detail5220
- 10. Purple Detail.....3030
- 11. Orange Candy.....1030
- 12. Tan Swirls1141
- 13. White Detail.....0015
- 14. Cover Stitch and Lace0015

DESIGNS



Note: Some designs in this collection may have been created using unique special stitches and/or techniques. To preserve design integrity when rescaling or rotating designs in your software, always rescale or rotate designs using the handles directly on-screen.

FABRIC REQUIRED

51234-03 Side Wall 1 FSA

Size Inches: Size mm: Stitch Count:
1.56 X 4.51 in. 39.6 X 114.6 mm 9771 St.

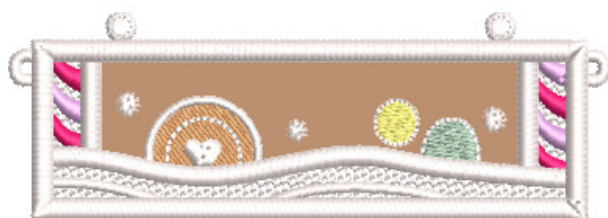

- 1. Brown Fabric Placement Stitch.....0015
- 2. Cut Line and Tackdown.....0015
- 3. Grid0015
- 4. Red Stripes1900
- 5. Pink Stripes 2640
- 6. Yellow Candy.....0310
- 7. Green Candy5220
- 8. Orange Candy.....1030
- 9. White Detail.....0015
- 10. Cover Stitch and Lace0015

FABRIC REQUIRED

51234-04 Side Wall 2 FSA

Size Inches: Size mm: Stitch Count:
1.57 X 4.51 in. 39.9 X 114.6 mm 8841 St.

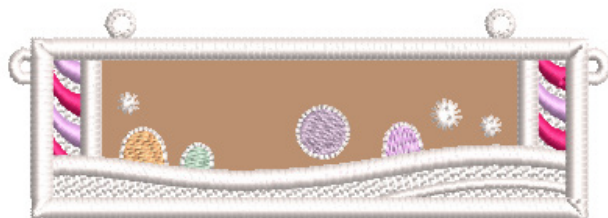

- 1. Brown Fabric Placement Stitch.....0015
- 2. Cut Line and Tackdown.....0015
- 3. Grid0015
- 4. Pink Stripes and Candy 2640
- 5. Red Stripes1900
- 6. Orange Candy.....1030
- 7. Green Candy5220
- 8. Purple Candy3030
- 9. White Detail.....0015
- 10. Cover Stitch and Lace0015

DESIGNS



Note: Some designs in this collection may have been created using unique special stitches and/or techniques. To preserve design integrity when rescaling or rotating designs in your software, always rescale or rotate designs using the handles directly on-screen.

FABRIC REQUIRED

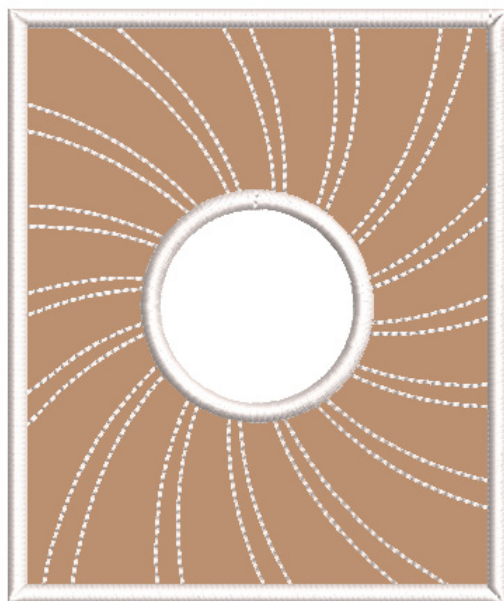

51234-05 Foundation FSA

Size Inches: Size mm: Stitch Count:
4.97 X 4.16 in. 126.2 X 105.7 mm 8755 St.

- 1. Brown Fabric Placement Stitch.....0015
- 2. Cut Line and Tackdown.....0015
- 3. White Detail.....0015
- 4. Cover Stitch and Lace0015

FABRIC REQUIRED

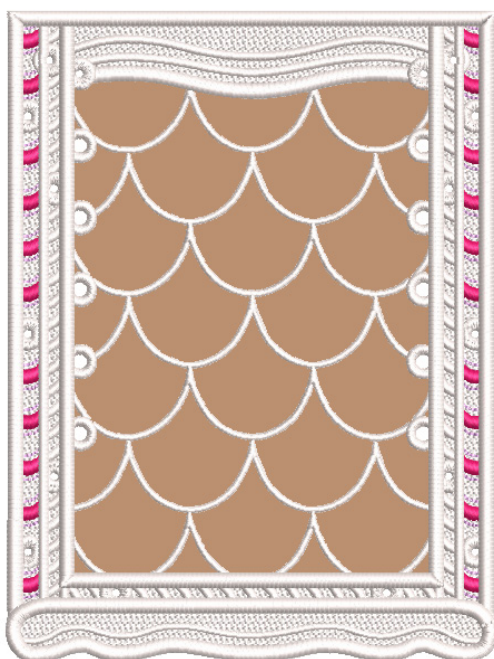

51234-06 Roof FSA

Size Inches: Size mm: Stitch Count:
6.84 X 5.16 in. 173.7 X 131.1 mm 47206 St.

- 1. Brown Fabric Placement Stitch.....0015
- 2. Cut Line and Tackdown.....0015
- 3. Grid0015
- 4. Red Stripes1900
- 5. Pink Stripes 2640
- 6. Roof Detail.....0015
- 7. Cover Stitch and Lace0015

DESIGNS



Note: Some designs in this collection may have been created using unique special stitches and/or techniques. To preserve design integrity when rescaling or rotating designs in your software, always rescale or rotate designs using the handles directly on-screen.

FABRIC REQUIRED

51234-07 Shingles 1 FSA

Size Inches: Size mm: Stitch Count:
1.89 X 4.06 in. 48.0 X 103.1 mm 9135 St.

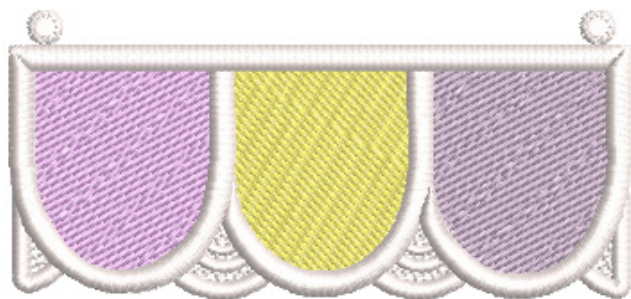

- 1. White Fabric Placement Stitch0015
- 2. Cut Line and Tackdown.....0015
- 3. Purple Shingle3030
- 4. Yellow Shingle0310
- 5. Pink Shingle..... 2640
- 6. White Lace and Cover Stitch0015

FABRIC REQUIRED

51234-08 Shingles 2 FSA

Size Inches: Size mm: Stitch Count:
1.89 X 4.06 in. 48.0 X 103.1 mm 7759 St.

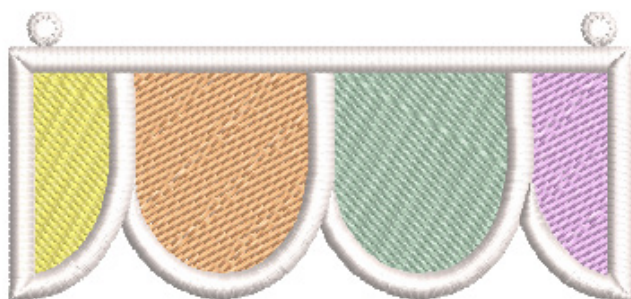

- 1. White Fabric Placement Stitch0015
- 2. Cut Line and Tackdown.....0015
- 3. Pink Shingle..... 2640
- 4. Green Shingle.....5220
- 5. Orange Shingle1030
- 6. Yellow Shingle0310
- 7. Cover Stitch and Lace0015

DESIGNS



Note: Some designs in this collection may have been created using unique special stitches and/or techniques. To preserve design integrity when rescaling or rotating designs in your software, always rescale or rotate designs using the handles directly on-screen.

FABRIC REQUIRED

51234-09 Shingles 3 FSA

Size Inches: Size mm: Stitch Count:
1.88 X 4.06 in. 47.8 X 103.1 mm 7038 St.



- 1. White Fabric Placement Stitch0015
- 2. Cutline and Tackdown0015
- 3. Yellow Shingle0310
- 4. Pink Shingle..... 2640
- 5. Green Shingle.....5220
- 6. Cover Stitch and Lace0015

FABRIC REQUIRED

51234-10 Shingles 4 FSA

Size Inches: Size mm: Stitch Count:
1.89 X 4.06 in. 48.0 X 103.1 mm 7668 St.

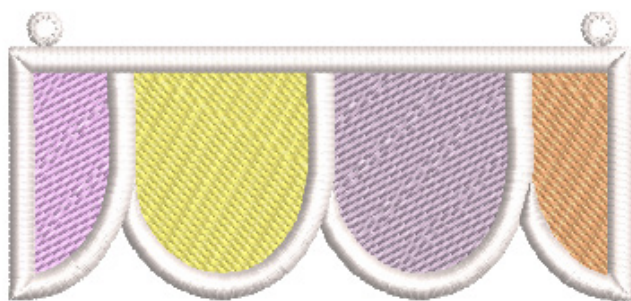

- 1. White Fabric Placement Stitch0015
- 2. Cut Line and Tackdown.....0015
- 3. Orange Shingle1030
- 4. Purple Shingle3030
- 5. Yellow Shingle0310
- 6. Pink Shingle..... 2640
- 7. Cover Stitch and Lace0015

DESIGNS



Note: Some designs in this collection may have been created using unique special stitches and/or techniques. To preserve design integrity when rescaling or rotating designs in your software, always rescale or rotate designs using the handles directly on-screen.

FABRIC REQUIRED

51234-11 Shingles 5 FSA

Size Inches: Size mm: Stitch Count:
1.88 X 4.06 in. 47.8 X 103.1 mm 7024 St.



- 1. White Fabric Placement Stitch0015
- 2. Cut Line and Tackdown.....0015
- 3. Pink Shingle..... 2640
- 4. Green Shingle.....5220
- 5. Orange Shingle1030
- 6. Cover Stitch and Lace0015

FABRIC REQUIRED

51234-12 Shingles 6 FSA

Size Inches: Size mm: Stitch Count:
1.89 X 4.06 in. 48.0 X 103.1 mm 7759 St.

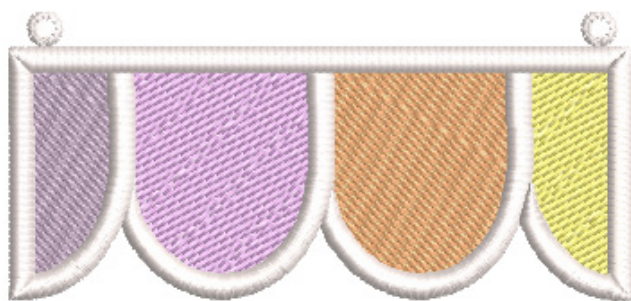

- 1. White Fabric Placement Stitch0015
- 2. Cut Line and Tackdown.....0015
- 3. Yellow Shingle0310
- 4. Orange Shingle1030
- 5. Pink Shingle..... 2640
- 6. Purple Shingle3030
- 7. Cover Stitch and Lace0015

DESIGNS



Note: Some designs in this collection may have been created using unique special stitches and/or techniques. To preserve design integrity when rescaling or rotating designs in your software, always rescale or rotate designs using the handles directly on-screen.

FABRIC REQUIRED

51234-13 Shingles Top FSA

Size Inches: **3.29 X 4.68 in.** Size mm: **83.6 X 118.9 mm** Stitch Count: **21268 St.**

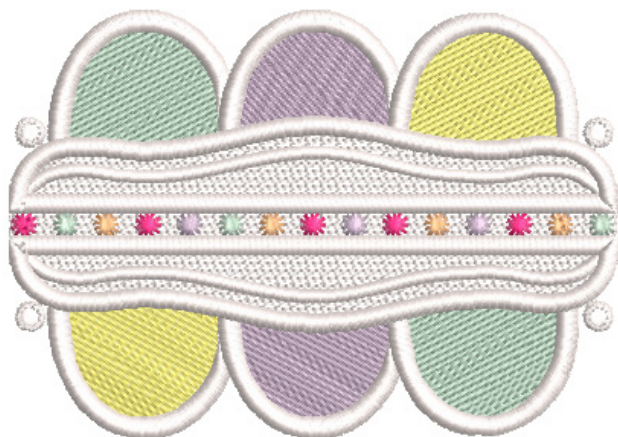

- 1. White Fabric Placement Stitch0015
- 2. Cut Line and Tackdown.....0015
- 3. Grid0015
- 4. Green Shingles and Dots5220
- 5. Orange Dots.....1030
- 6. Red Dots.....1900
- 7. Purple Shingles and Dots3030
- 8. Yellow Shingles0310
- 9. Cover Stitch.....0015

51234-14 Icicles FSL

Size Inches: **6.06 X 5.24 in.** Size mm: **153.9 X 133.1 mm** Stitch Count: **18357 St.**

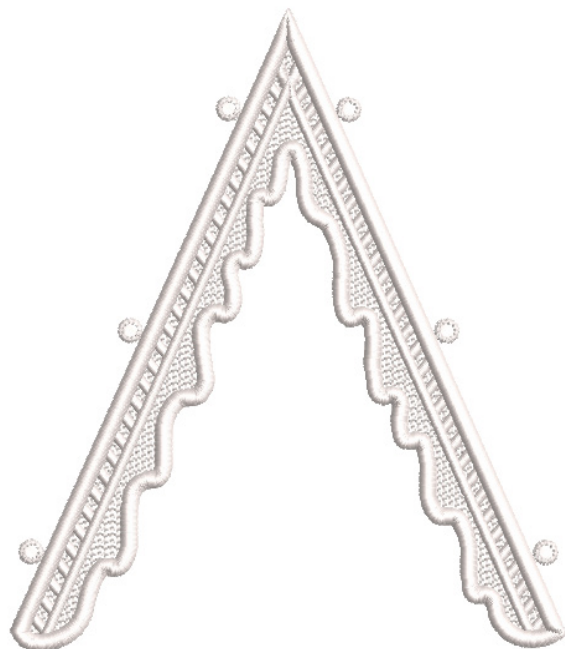

- 1. Single Color Design0015

DESIGNS



Note: Some designs in this collection may have been created using unique special stitches and/or techniques. To preserve design integrity when rescaling or rotating designs in your software, always rescale or rotate designs using the handles directly on-screen.

FABRIC REQUIRED

51234-15 Candy 1 FSA

Size Inches: **1.41 X 1.42 in.** Size mm: **35.8 X 36.1 mm** Stitch Count: **2563 St.**



- 1. White Fabric Placement Stitch1900
- 2. Cut Line and Tackdown.....1900
- 3. Red Swirls1900
- 4. Cover Stitch..... 2640
- 5. Purple Detail.....3030

FABRIC REQUIRED

51234-16 Button 1 FSA

Size Inches: **1.24 X 1.23 in.** Size mm: **31.5 X 31.2 mm** Stitch Count: **1611 St.**



- 1. Pink Fabric Placement Stitch0015
- 2. Cut Line and Tackdown.....0015
- 3. Cover Stitch.....0015
- 4. Red Detail1900
- 5. Purple Detail.....3030

DESIGNS



Note: Some designs in this collection may have been created using unique special stitches and/or techniques. To preserve design integrity when rescaling or rotating designs in your software, always rescale or rotate designs using the handles directly on-screen.

FABRIC REQUIRED

51234-17 Candy 2 FSA

Size Inches: Size mm: Stitch Count:
1.74 X 1.73 in. **44.2 X 43.9 mm** **3124 St.**



- 1. White Fabric Placement Stitch3030
- 2. Cut Line and Tackdown.....3030
- 3. Red Swirl.....1900
- 4. Cover Stitch.....3030
- 5. Pink Detail..... 2640

FABRIC REQUIRED

51234-18 Snowflake FSA

Size Inches: Size mm: Stitch Count:
1.76 X 1.62 in. **44.7 X 41.1 mm** **3209 St.**

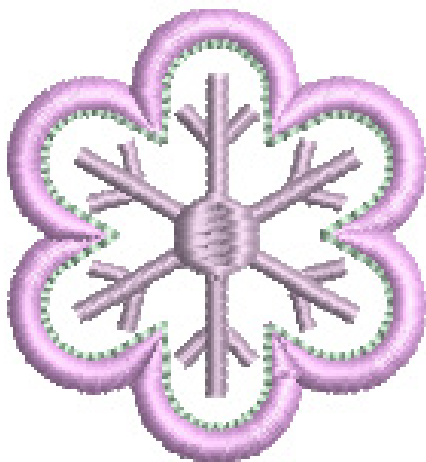

- 1. White Fabric Placement Stitch 2640
- 2. Cut Line and Tackdown..... 2640
- 3. Cover Stitch..... 2640
- 4. Purple Snowflake3030
- 5. Green Detail5220

DESIGNS



Note: Some designs in this collection may have been created using unique special stitches and/or techniques. To preserve design integrity when rescaling or rotating designs in your software, always rescale or rotate designs using the handles directly on-screen.

FABRIC REQUIRED

51234-19 Candy 3 FSA

Size Inches: Size mm: Stitch Count:
1.27 X 1.26 in. **32.3 X 32.0 mm** **2289 St.**

- 1. White Fabric Placement Stitch0310
- 2. Cut Line and Tackdown.....0310
- 3. Green Swirls5220
- 4. Yellow Detail and Cover Stitch0310
- 5. Purple Detail.....3030

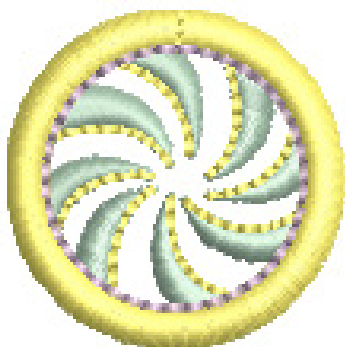

FABRIC REQUIRED

51234-20 Button 2 FSA

Size Inches: Size mm: Stitch Count:
1.07 X 1.07 in. **27.2 X 27.2 mm** **1026 St.**

- 1. Pink Fabric Placement Stitch0015
- 2. Cut Line and Tackdown.....0015
- 3. White Detail.....0015
- 4. Cover Stitch.....5220
- 5. Yellow Detail.....0310

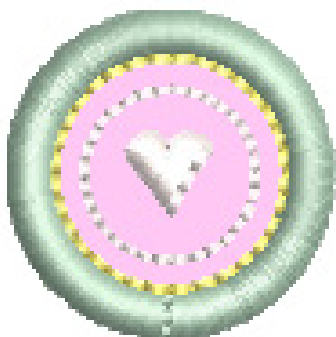

MATERIALS



Embroidery

- 6" x 10" hoop required for some designs

Stabilizer

- AquaMesh
- BadgeMaster
- StabilStick CutAway(for stiffening applique)

Fabric/Notions

- **Note:** Fabric requirements are estimates and may result in overage depending on hooping.
- 1/4-yard light brown for gingerbread pieces
- 1/8-yard white for tiles, back wall and accessories
- Scrap pink for door and accessories
- Isacord threads per thread chart
- Perfect Embroidery Press Cloth
- Perfect Punch Tool, or 3mm eyelet cutter
- Alligator Clamps (recommended)
- Snips
- Applique scissors
- Expert Embroidery Tape WashAway (recommended)
- Sewing machine required, with edgestitch foot or open toed foot (recommended)

SUMMARY



51234-01



Requires 1 Design

51234-02



Requires 1 Design

51234-03



Requires 1 Design

51234-04



Requires 1 Design

51234-05

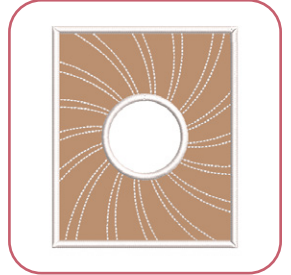

Requires 1 Design

51234-06

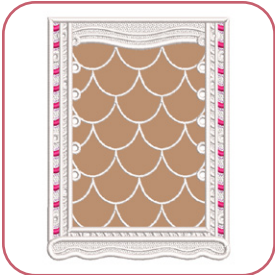

Requires 2 Designs

51234-07

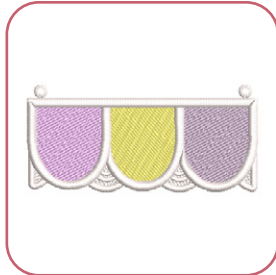

Requires 2 Designs

51234-08



Requires 2 Designs

51234-09

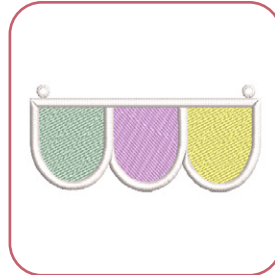

Requires 2 Designs

51234-10

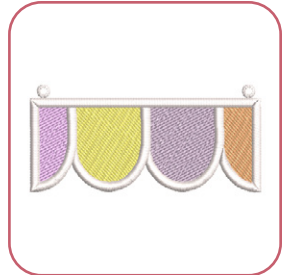

Requires 2 Designs

51234-11



Requires 2 Designs

51234-12

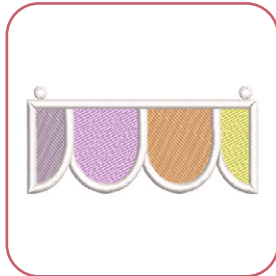

Requires 2 Designs

51234-13

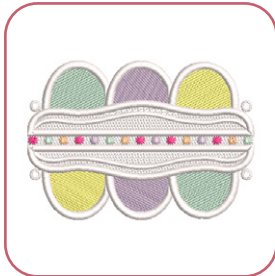

Requires 1 Design

51234-14

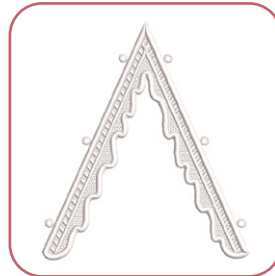

Requires 2 Designs

51234-15



Optional Design

51234-16



Optional Design

51234-17



Optional Design

51234-18

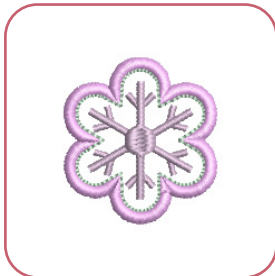

Optional Design

51234-19



Optional Design

51234-20



Optional Design

EMBROIDERY



Step 1

- Prep all applique fabric with two layers of StabilStick CutAway applied to the back of the fabric to provide stability.
- All FSA (Freestanding Applique) designs use similar instructions, but less complicated than design 51234-01 which follows.



Step 2

- Hoop 1 layer of AquaMesh with 1 layer of BadgeMaster.
- Load the machine with white thread.
- Load design 51234-01.



Step 3

- Attach the hoop to the machine.
- Stitch color 1, Brown Fabric Placement Stitch.



EMBROIDERY



Step 4

- Remove the hoop from the machine, but not the project from the hoop.
- Cut a piece of prepared brown fabric slightly larger than the placement stitch.
- Place the fabric over the placement line. Tape in place to secure.



Step 5

- Stitch Color 2, Cut Line and Tackdown.
- Remove the hoop from the machine, but not the fabric from the hoop.
- Closely trim away excess fabric only from the outer edge of the tackdown.
- Trim the window fabric away through all thicknesses of fabric and stabilizer.



Step 6

- Cover the window opening with Expert Embroidery Tape WashAway.
- Note: This process makes it easier to remove the fabric from an inside hole. The tape provides stabilization for the window stitches. Alternatively a piece of AquaMesh Plus may be used, or AquaMesh or BadgeMaster in combination with temporary adhesive spray.
- Return the hoop to the machine.

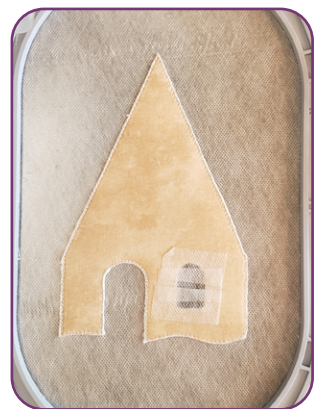

EMBROIDERY



Step 7

- Stitch color 3, Pink Fabric Placement Stitch.
- Place prepared pink fabric over the placement stitch. Tape to secure.



Step 8

- Stitch color 4, Cut Line and Tackdown.
- Gently remove the hoop from the machine, but not the project from the hoop. Trim away excess pink fabric close to the tackdown line.
- Return the hoop to the machine.
- Finish stitching the design using the thread chart as a guide.
- Use the same method to stitch all the FSA designs needed to build the structure. Design 14 is FSL, freestanding lace, and does not require any fabric.



ASSEMBLY



Step 1

- Rinse all design pieces in warm running water until the water-soluble stabilizers are no longer visible.
- Dry flat, face down on a non-stick surface such as a cookie sheet, cooling grid, or wax paper. Do not dry on a terry towel or similar since the wet pieces are may stick to the towel fibers.
- Press all dried pieces face down on a Perfect Embroidery Press Cloth with steam. Allow to cool in place before moving them.



Step 2

- Layout pieces 01-05, as shown.



Step 3

- At the sewing machine, stitch each side to the base with a serpentine (multi-step zigzag) stitch in white thread.



ASSEMBLY



Step 4

- Fold up the sides, perpendicular to the base. Press the crease if desired.
- Attach the sides to each other by pulling the buttonettes on the Front Wall and Back Wall through the eyelets on the two Side Walls, as shown. Set aside.



Step 5

- With the OESD Perfect Punch Tool or a 3mm eyelet cutter, cut out the 10 holes on each roof section O6 as shown.

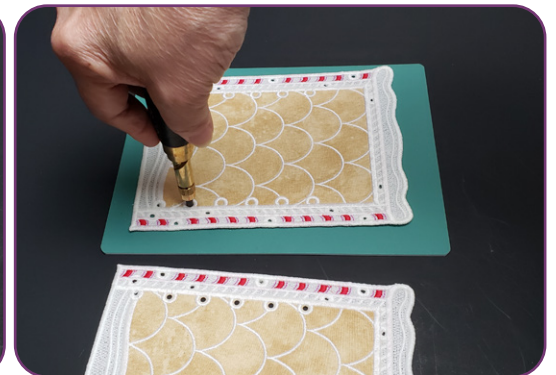
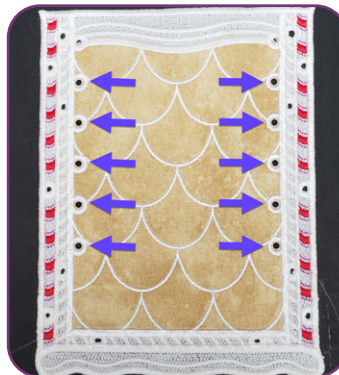

Step 6

- Layout the tiles, designs O7-12, in ascending order, as shown.



ASSEMBLY



Step 7

- Starting at the bottom of the roof, pull the buttonettes on Tiles 07 through the recently punched eyelets as shown. Continue with each tile section in numerical order.
- Repeat for the other roof section.



Step 8

- Attach design 13, Shingles Top, to both sections of the roof, as shown.



Step 9

- Attach the Front, Back and each Side section to the roof, as shown.

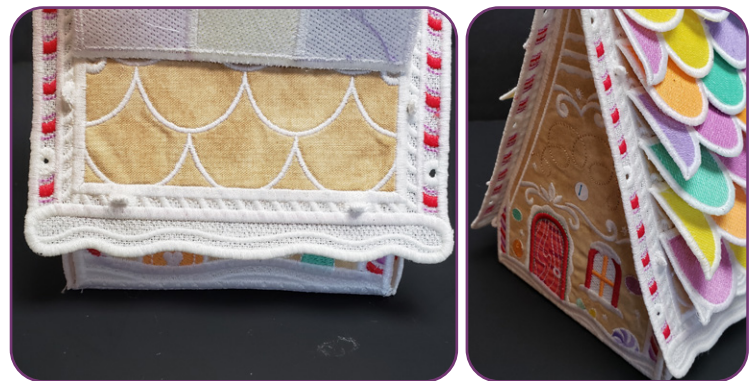

ASSEMBLY



Step 10

- Finally attach each Icicle section, design 14, under the roof eaves by pulling the icicle buttonettes up through the outer most three eyelets on each side of the roof, front and back.



Step 11

- The Sugar Chalet assembly is now complete.
- Use the candy, button, and snowflake designs as additional adornment on the chalet, scattered around the display or as a stepping-stone path to the door.



INSTRUCTIONS



Supplies:

Embroidery Thread:

- Use the same embroidery thread in the bobbin as the needle.

Needles:

- Use an Organ 80/12 Titanium needle for extended needle life.

Stabilizer:

- Use OESD AquaMesh stabilizer.

Handy Hints:

For Stiffer Lace:

- DO NOT rinse away all of the stabilizer for a “stiffer” lace. Note that the thread may appear a shade darker if stabilizer is not removed completely.
- If you happen to wash too much out, easily re-stiffen by diluting some stabilizer scraps in water and dipping the item in the solution.

For Very Soft Lace:

- Cut away excess stabilizer. Remove remaining stabilizer by rinsing under warm running water until all traces of the stabilizer are gone. **NOTE:** If lace should become too limp to work with, dissolve stabilizer scraps in warm water and apply to the lace.

Drying Lace:

- The lace looks best when left to dry completely. Lay lace piece with right side down to dry. This will minimize the tendency for the lace to curl. Be sure to flatten the piece out entirely and allow ample time to dry.

General Instructions

1. Hoop two layers of OESD AquaMesh Stabilizer.
2. Attach the hoop to the machine and select the design of your choice.
3. Stitch the design.
4. Remove the hoop from the machine and the design from the hoop. Trim excess stabilizer from the design.
5. Rinse away remaining stabilizer and allow it to dry.

Handy Hints:

For 3D Lace Projects:

- If item becomes too limp to work with, iron the lace pieces on the wrong side while applying spray starch. After ironing, spray again with starch and allow to dry completely. This will stiffen the lace pieces nicely and aid in construction.
- A pair of tweezers, hemostats, stiletto or a tiny crochet hook can be extremely helpful when inserting the buttonettes into the eyelets. (Please see **Diagram 1** for explanation of “buttonette” and “eyelet”.)
- Insert the tip of the alligator clamps, tweezers, hemostats or crochet hook into the eyelet, grasp the buttonette and pull through the eyelet. Or a stiletto could be used to push the buttonette through the eyelet.

Diagram 1

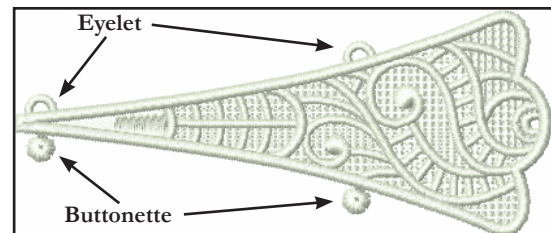

INSTRUCTIONS



ATTENTION

When printing this document, any page scaling or page fitting options in your print dialog box must be turned OFF or set to NONE so that your files will print out at their actual size. Images not printed at actual size will not function as intended.

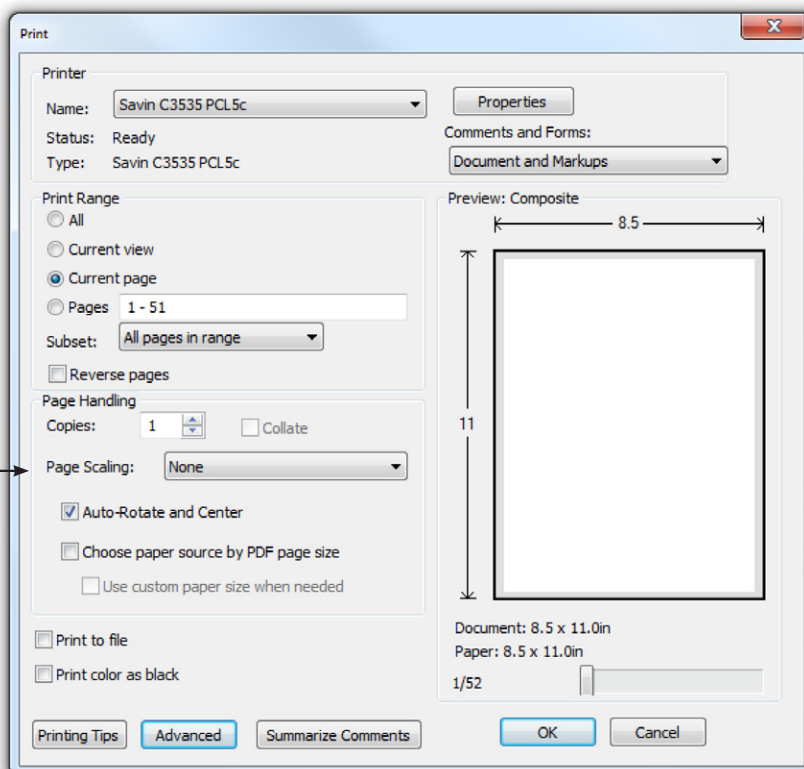

TO SAVE PAPER

Only print the desired image by navigating to the image's page, go to File > Print and select "Current page" in the print dialog box. Repeat for each desired image.

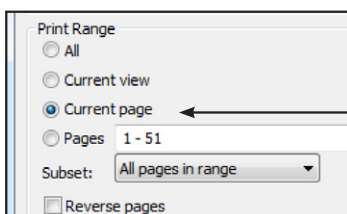

APPLIQUE PATTERNS

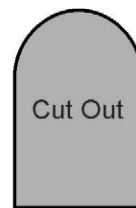
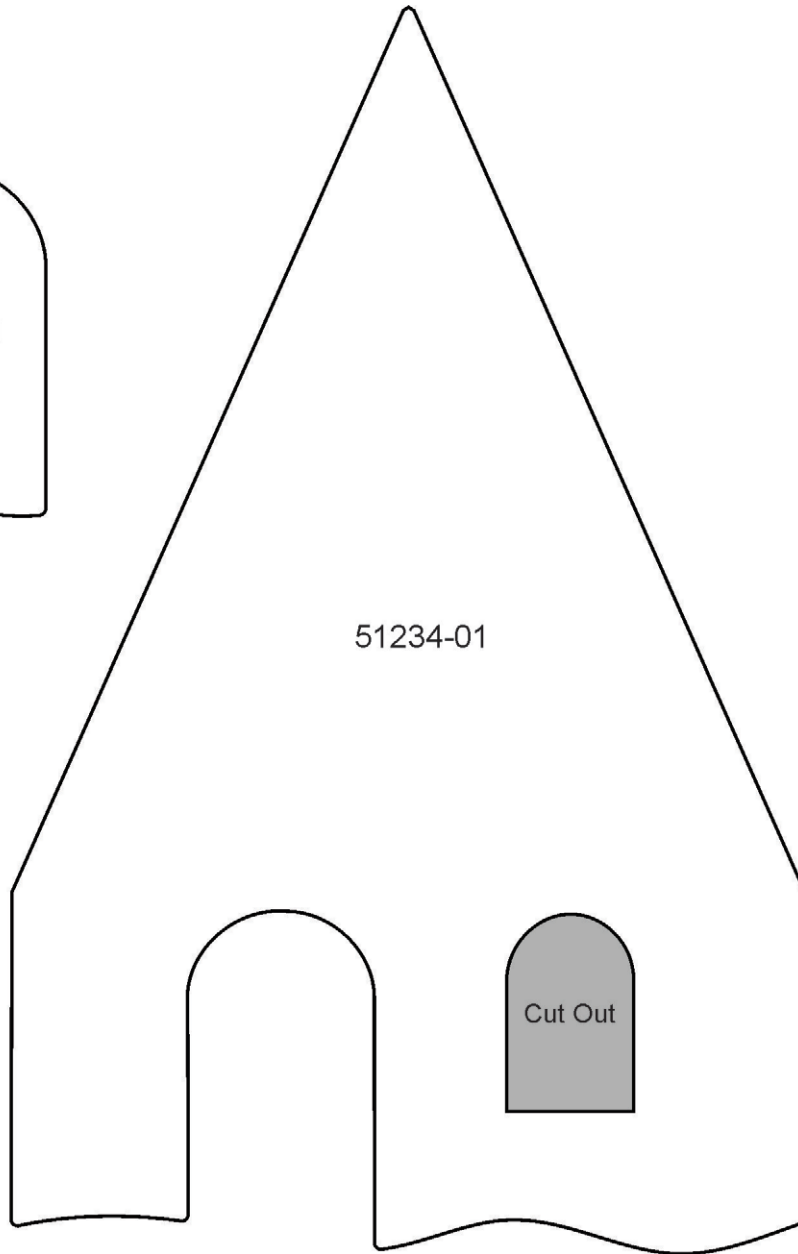

APPLIQUE PATTERNS

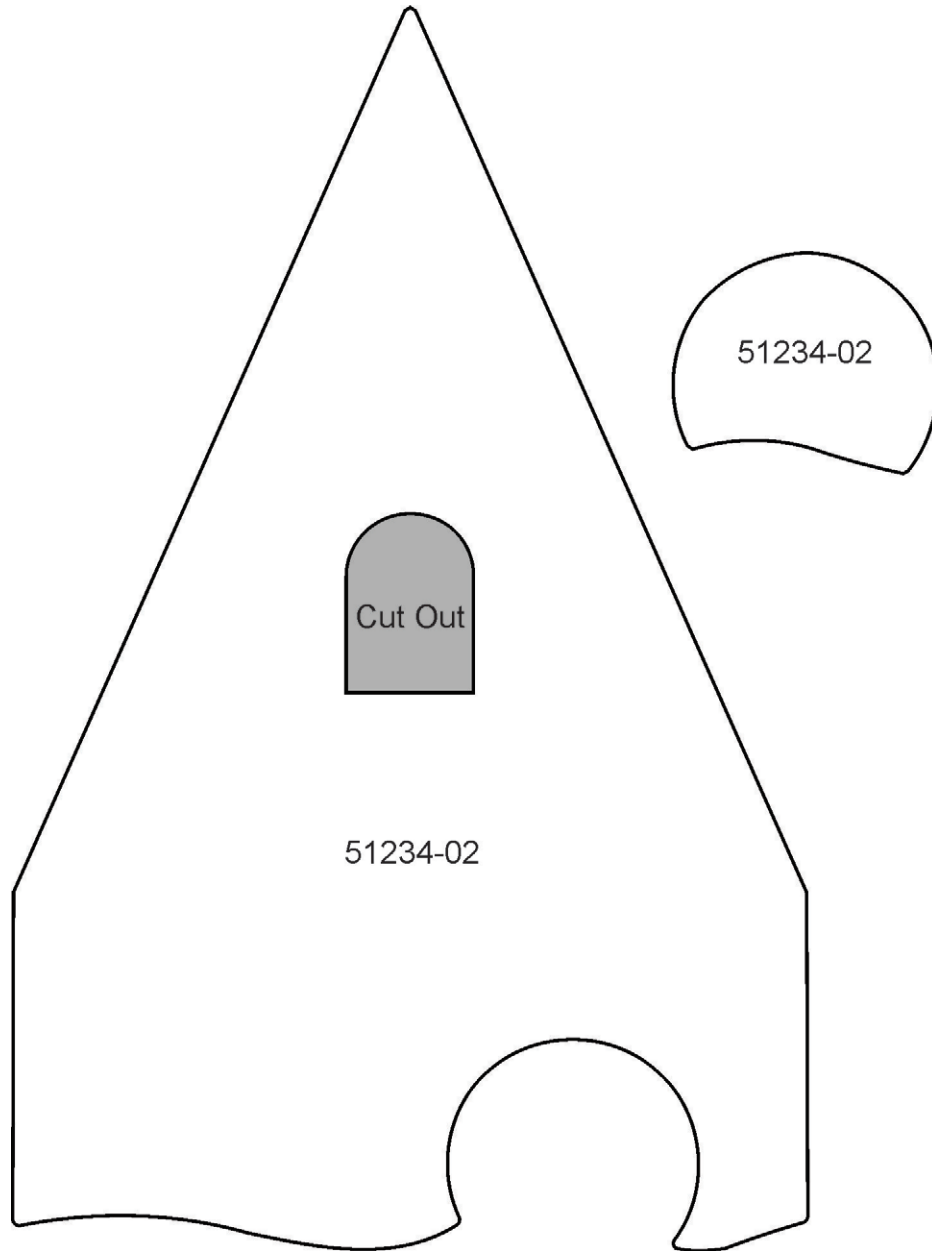

APPLIQUE PATTERNS

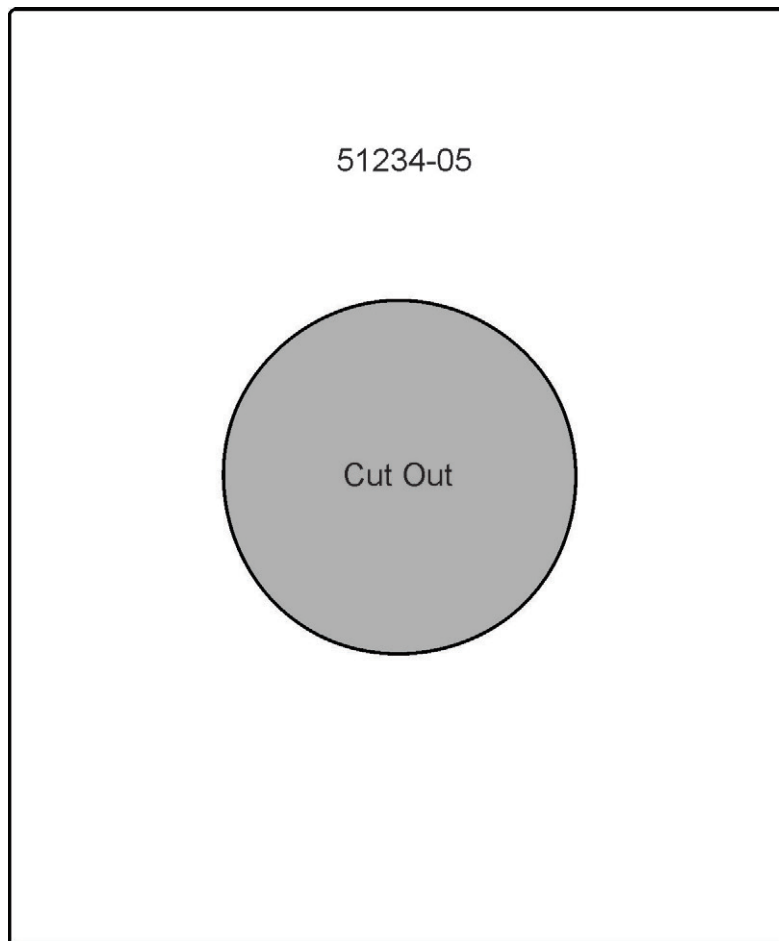
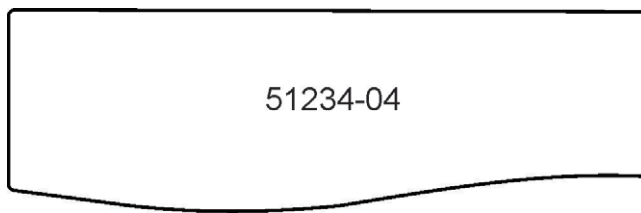
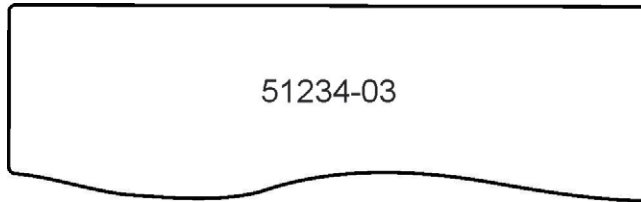

APPLIQUE PATTERNS

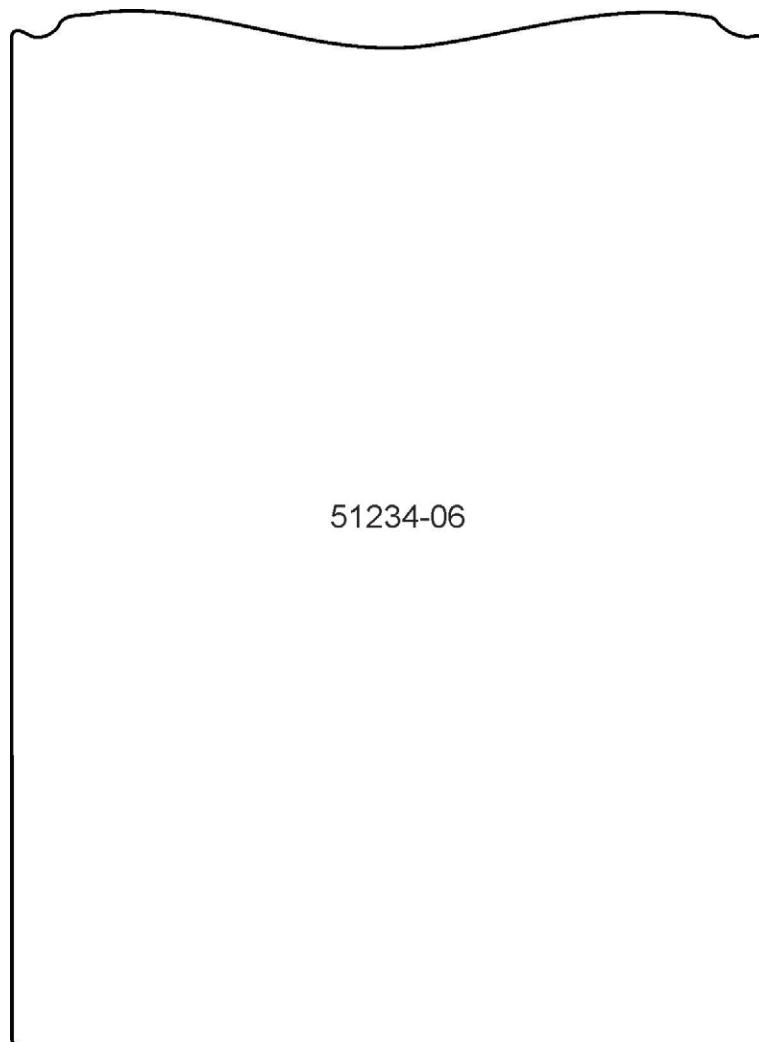

51234-06

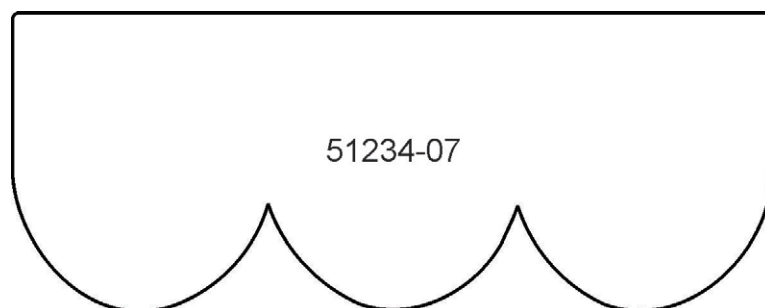

51234-07

APPLIQUE PATTERNS

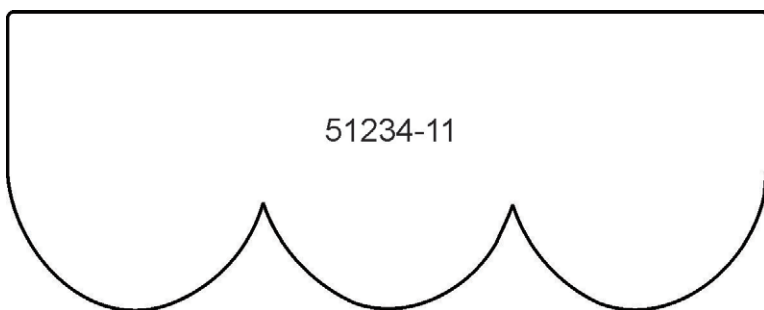
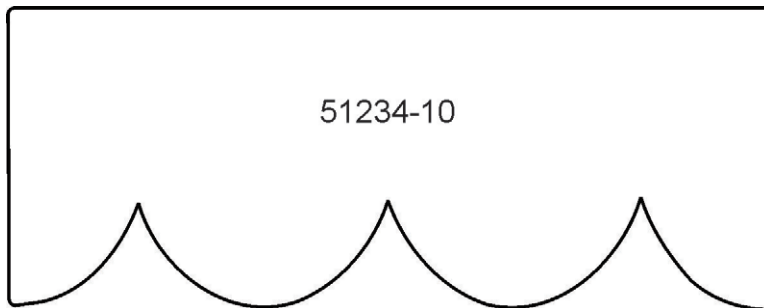
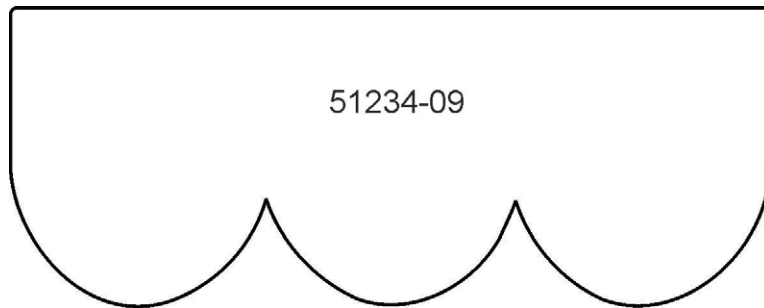
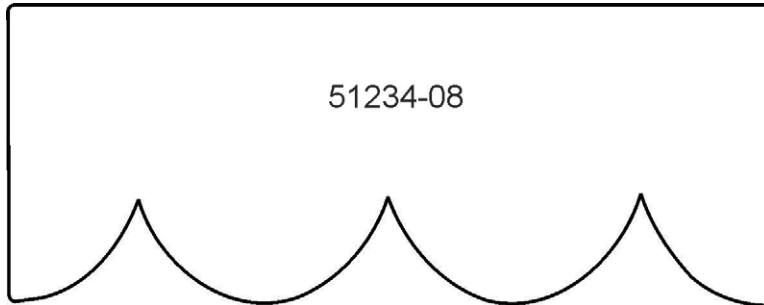

APPLIQUE PATTERNS

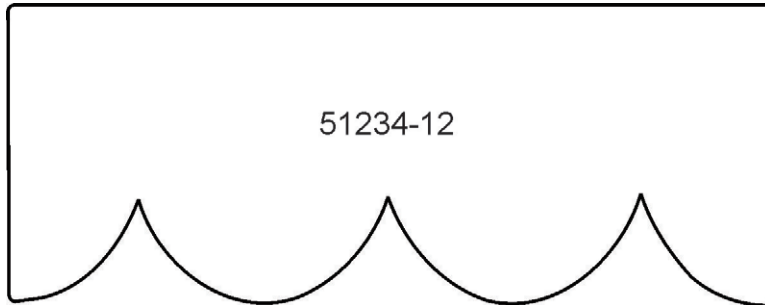

51234-12

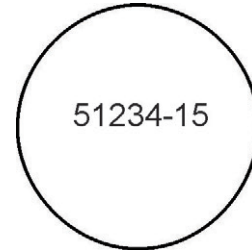

51234-15

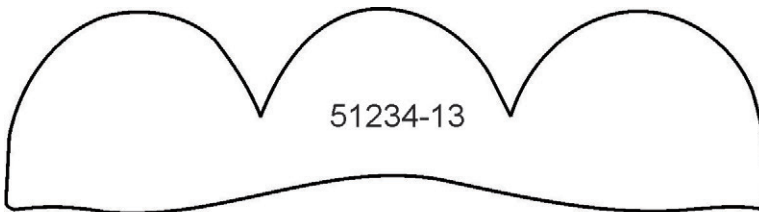

51234-13

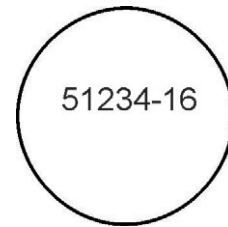

51234-16

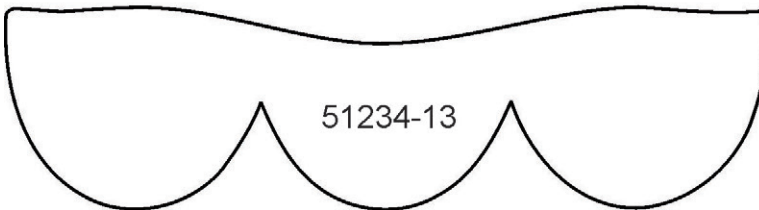

51234-13

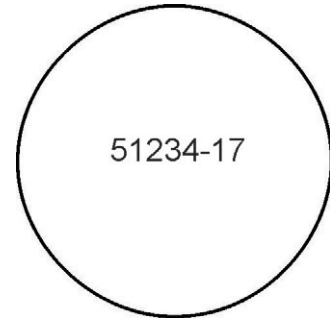

51234-17



51234-18

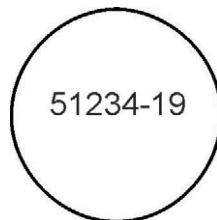

51234-19

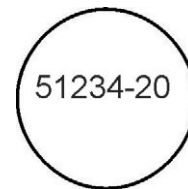

51234-20

MIRRORED PATTERNS

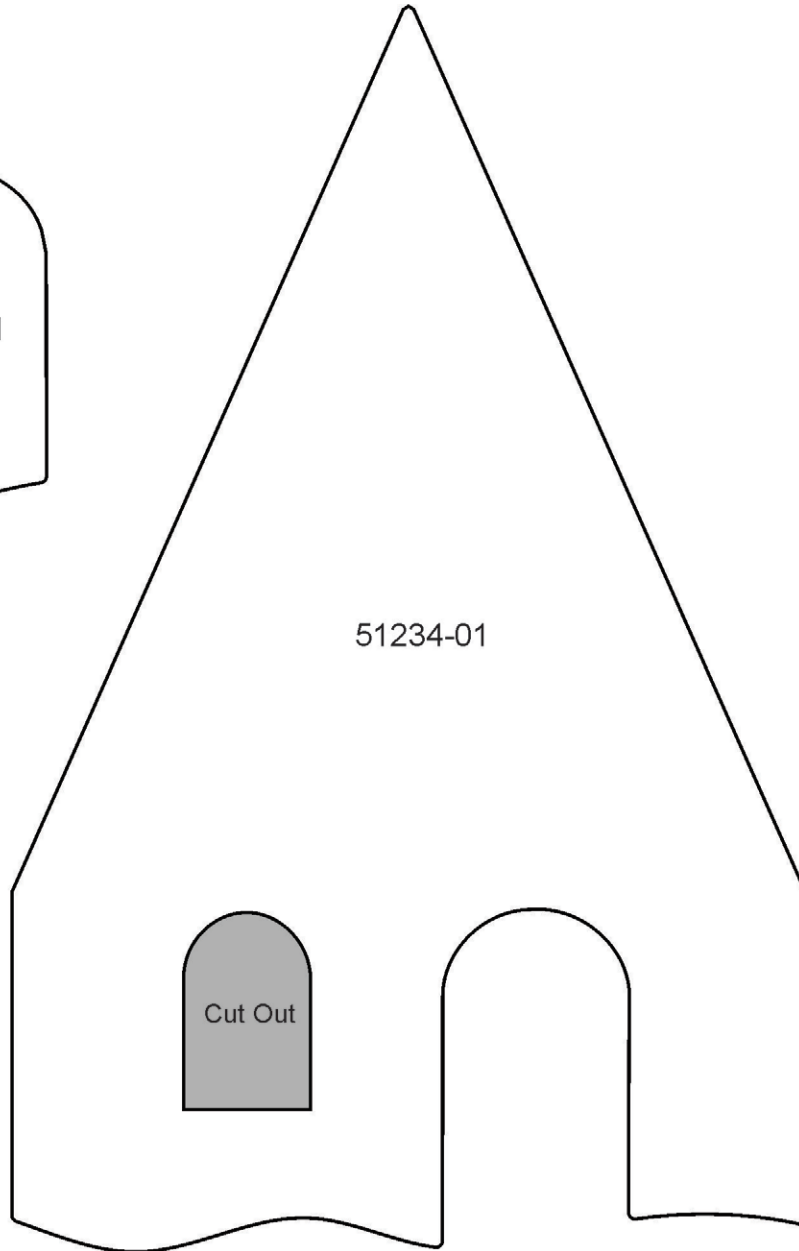
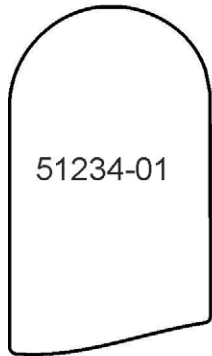

MIRRORED PATTERNS

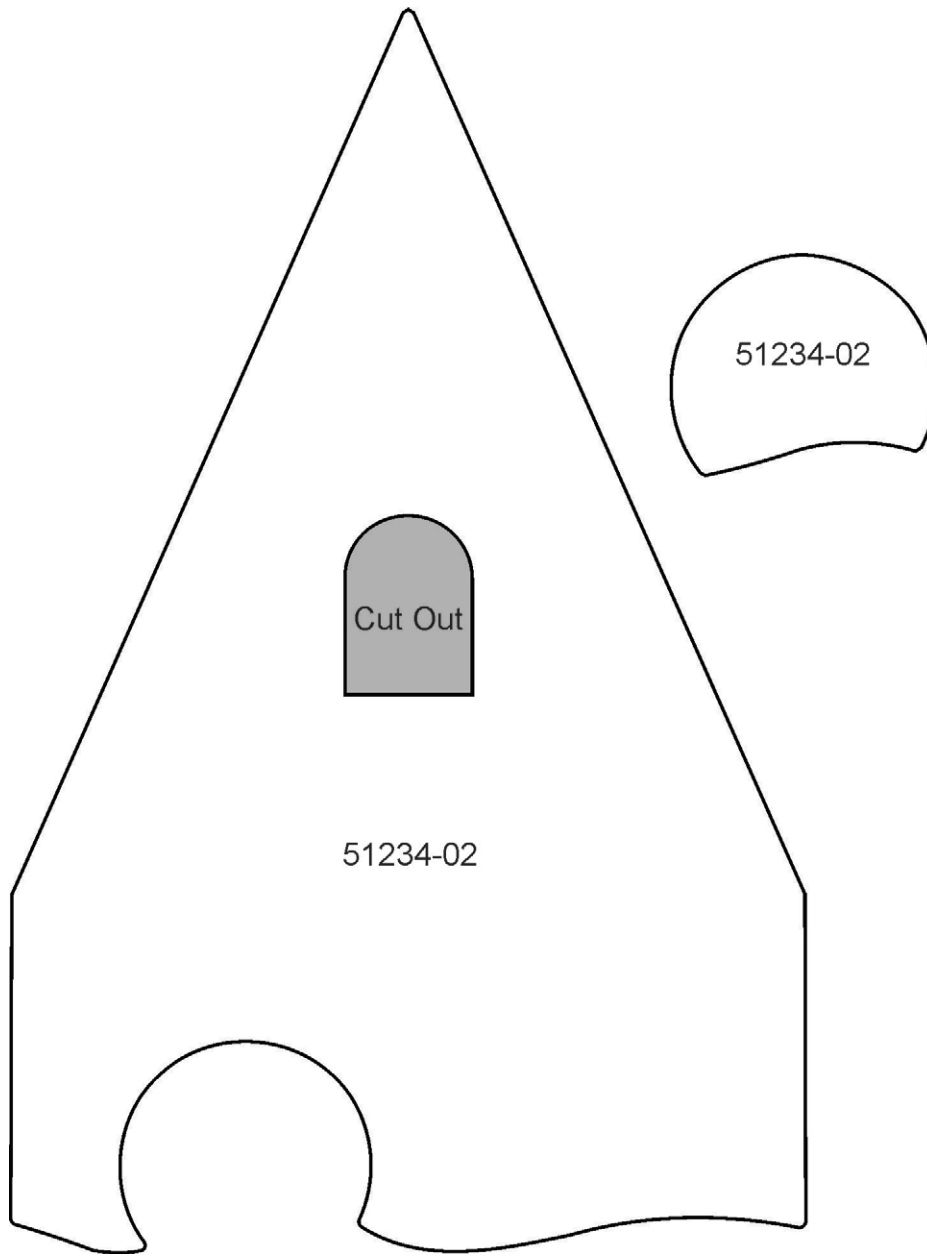

MIRRORED PATTERNS



51234-03

51234-04

51234-05

Cut Out

MIRRORED PATTERNS

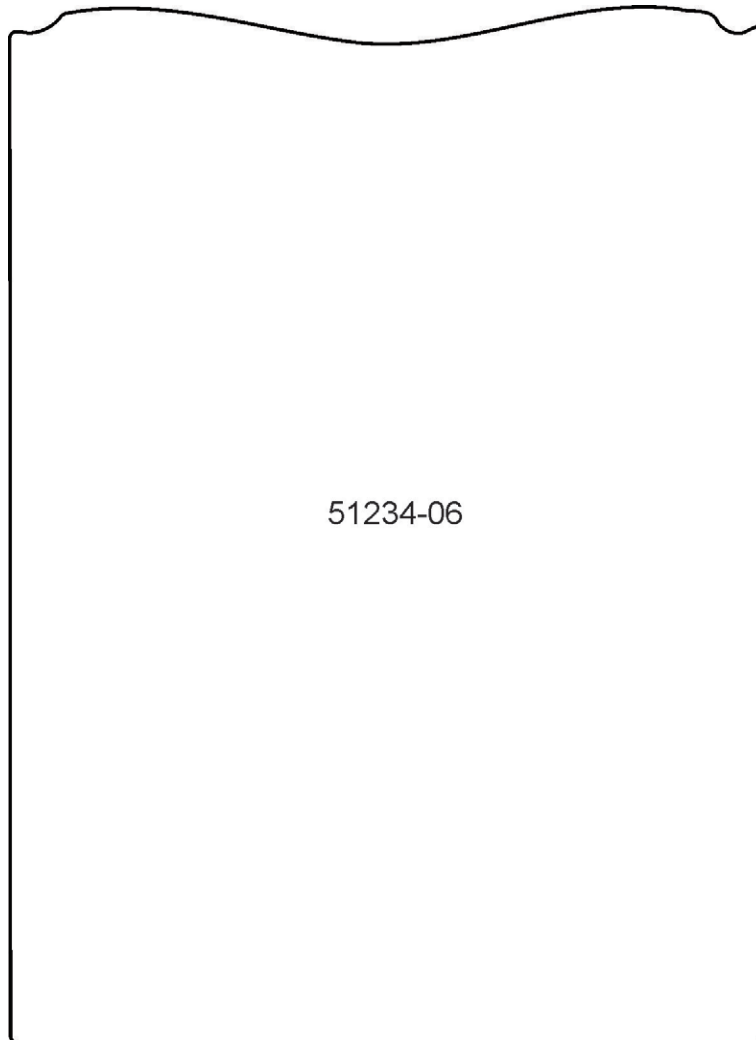

51234-06

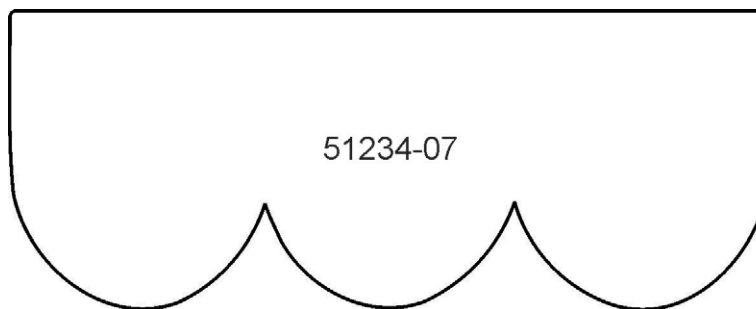

51234-07

MIRRORED PATTERNS

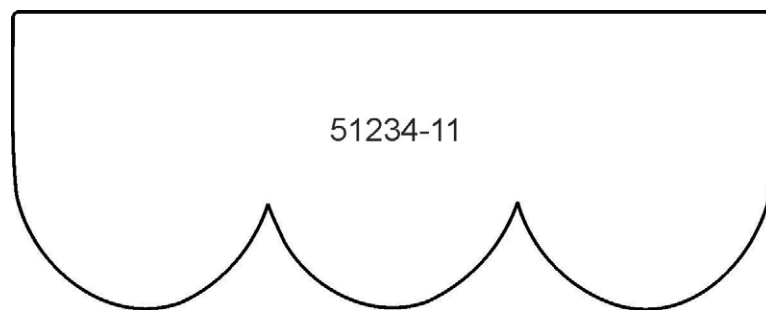
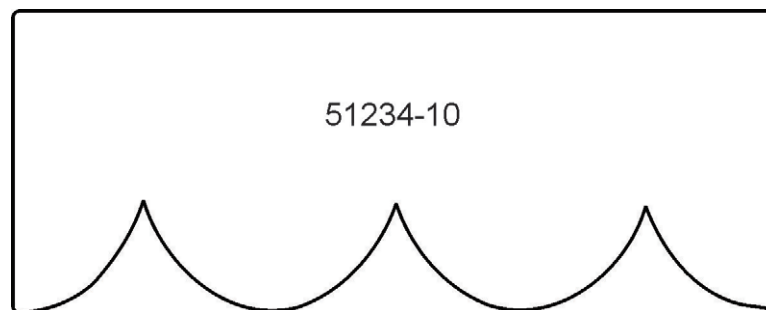
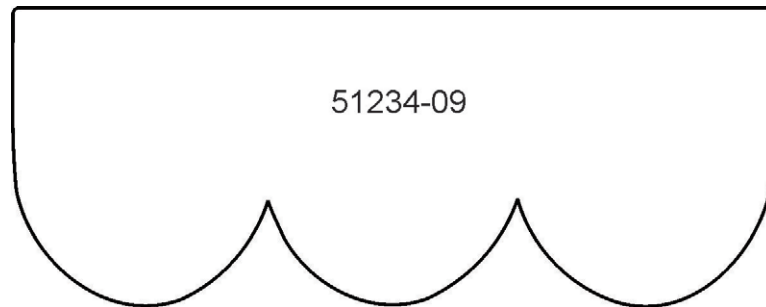
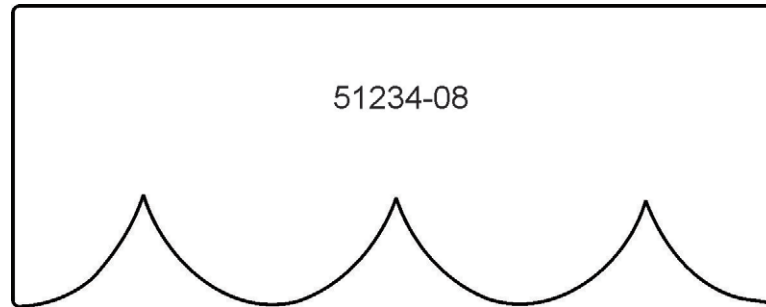

MIRRORED PATTERNS

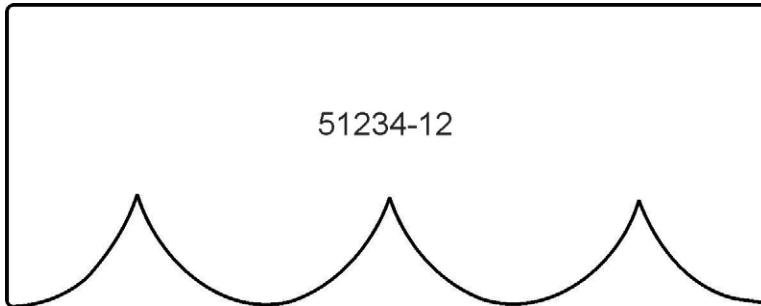

51234-12

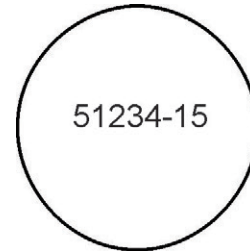

51234-15

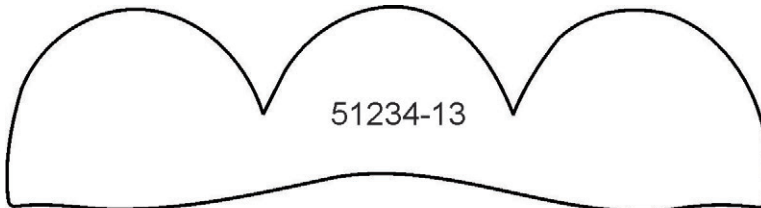

51234-13

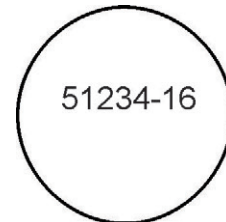

51234-16

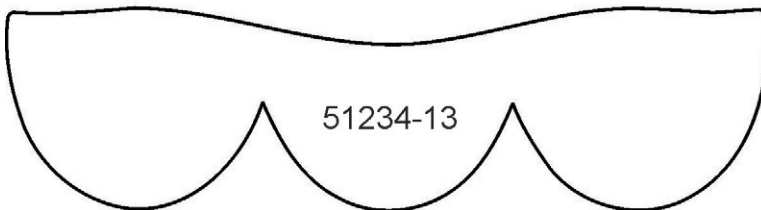

51234-13

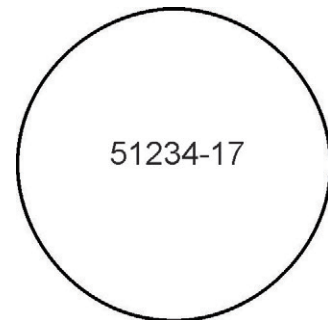

51234-17



51234-18

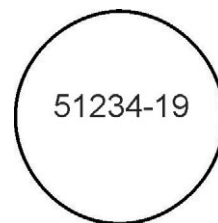

51234-19

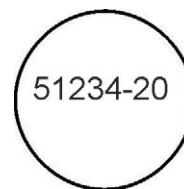

51234-20



#51257
3 DESIGNS



FREESTANDING CANDY COTTAGE

It is a violation of Copyright law to make and distribute copies of electronic designs or artwork.
Electronic designs are licensed to the original purchaser for use at one location. ©2021 OESD, LLC. All rights reserved.

MATERIALS



Isacord Thread Colors

- 0015 White (2 spools)
- 1133 Peru
- 1753 Strawberries N' Cream
- 2155 Pink Tulip
- 4430 Island Waters
- 5440 Mint

*** Project instructions included after design list.**

Note: One spool of 1000 meter thread is adequate for the project unless otherwise noted.

FABRIC REQUIRED



51257-01 Front Wall FSA

Size Inches: Size mm: Stitch Count:
5.99 X 4.62 in. 152.2 X 117.2 mm 27376 St.

- 1. Brown Fabric Placement Stitch 0015
- 2. Cut Line and Tackdown 0015
- 3. Green Fabric Placement Stitch 0015
- 4. Cut Line and Tackdown 0015
- 5. White Lace Fill 0015
- 6. Tan Detail 1133
- 7. Pink Lace 1753
- 8. Green Lace and Detail 5440
- 9. Light Pink Lace and Detail 2155
- 10. Light Blue Detail 4430
- 11. White Detail 0015
- 12. White Lace and Detail 0015

DESIGNS



Note: Some designs in this collection may have been created using unique special stitches and/or techniques. To preserve design integrity when rescaling or rotating designs in your software, always rescale or rotate designs using the handles directly on-screen.

FABRIC REQUIRED

51257-02 Left Wall FSA

Size Inches: Size mm: Stitch Count:
3.00 X 4.06 in. 76.2 X 103.1 mm 21421 St.



- 1. Brown Fabric Placement Stitch 0015
- 2. Cut Line and Tackdown 0015
- 3. White Lace Fill 0015
- 4. White Detail 0015
- 5. Light Pink Lace and Detail 2155
- 6. Pink Lace and Detail 1753
- 7. Green Lace and Detail 5440
- 8. Light Pink Candy Cane 2155
- 9. Light Blue Detail 4430
- 10. White Detail 0015
- 11. White Lace and Detail 0015

DESIGNS



Note: Some designs in this collection may have been created using unique special stitches and/or techniques. To preserve design integrity when rescaling or rotating designs in your software, always rescale or rotate designs using the handles directly on-screen.

FABRIC REQUIRED



51257-03 Back Wall FSA

Size Inches: Size mm: Stitch Count:
6.06 X 4.75 in. 154.0 X 120.7 mm 28522 St.

<input type="checkbox"/>	1. Brown Fabric Placement Stitch	0015
<input type="checkbox"/>	2. Cut Line and Tackdown	0015
<input type="checkbox"/>	3. Green Fabric Placement Stitch	0015
<input type="checkbox"/>	4. Cut Line and Tackdown	0015
<input type="checkbox"/>	5. White Lace Fill	0015
<input type="checkbox"/>	6. Tan Detail	1133
<input type="checkbox"/>	7. Light Pink Lace and Detail	2155
<input type="checkbox"/>	8. Pink Lace and Detail	1753
<input type="checkbox"/>	9. Light Blue Detail	4430
<input type="checkbox"/>	10. Green Lace and Detail	5440
<input type="checkbox"/>	11. Pink Detail	2155
<input type="checkbox"/>	12. Light Blue Detail	4430
<input type="checkbox"/>	13. White Detail	0015
<input type="checkbox"/>	14. Pink Detail	1753
<input type="checkbox"/>	15. White Detail	0015
<input type="checkbox"/>	16. White Lace and Detail	0015

DESIGNS



Note: Some designs in this collection may have been created using unique special stitches and/or techniques. To preserve design integrity when rescaling or rotating designs in your software, always rescale or rotate designs using the handles directly on-screen.

FABRIC REQUIRED

51257-04 Inner Wall FSA

Size Inches: Size mm: Stitch Count:
3.00 X 4.30 in. 76.3 X 109.2 mm 20552 St.

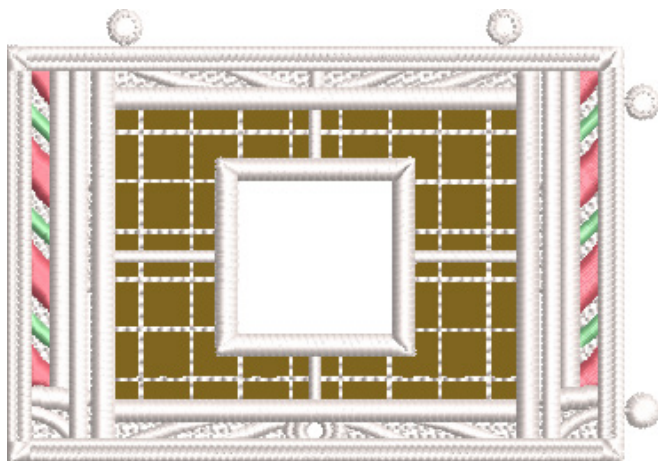

- 1. Brown Fabric Placement Stitch 0015
- 2. Cut Line and Tackdown 0015
- 3. Lace 0015
- 4. Pink Stripes 1753
- 5. Green Stripes 5440
- 6. Cover Stitch 0015

FABRIC REQUIRED

51257-05 Roof 1 FSA

Size Inches: Size mm: Stitch Count:
4.68 X 5.32 in. 118.9 X 135.0 mm 27078 St.

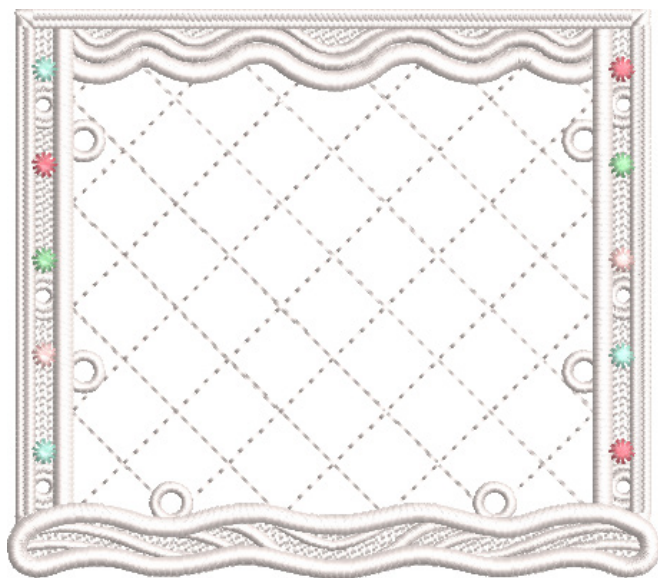

- 1. White Felt Placement Stitch 0015
- 2. Cut Line and Tackdown 0015
- 3. White Lace Fill 0015
- 4. White Lace and Detail 0015
- 5. Pink Dots 1753
- 6. Light Pink Dots 2155
- 7. Light Blue Dots 4430
- 8. Green Dots 5440

DESIGNS



Note: Some designs in this collection may have been created using unique special stitches and/or techniques. To preserve design integrity when rescaling or rotating designs in your software, always rescale or rotate designs using the handles directly on-screen.

FABRIC REQUIRED

51257-06 Roof 2 FSA

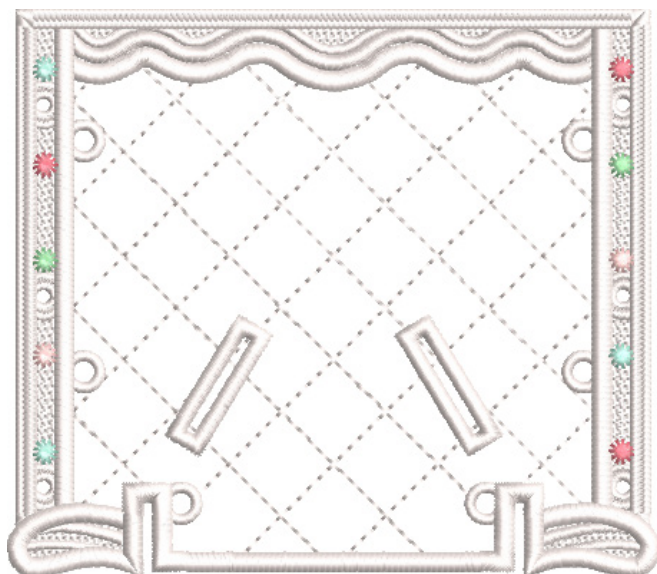

Size Inches: Size mm: Stitch Count:
4.66 X 5.32 in. 118.4 X 135.2 mm 26585 St.

- 1. White Felt Placement Stitch 0015
- 2. Cut Line and Tackdown 0015
- 3. White Lace Fill 0015
- 4. White Lace and Detail 0015
- 5. Light Blue Dots 4430
- 6. Green Dots 5440
- 7. Pink Dots 1753
- 8. Light Pink Dots 2155

FABRIC REQUIRED

51257-07 Front Walls FSA



Size Inches: Size mm: Stitch Count:
7.73 X 5.02 in. 196.3 X 127.4 mm 47260 St.

- 1. Brown Fabric Placement Stitch 0015
- 2. Cut Line and Tackdown 0015
- 3. White Lace Fill 0015
- 4. Light Blue Detail 4430
- 5. Light Pink Detail 2155
- 6. White Detail 0015
- 7. Green Detail 5440
- 8. Light Blue Detail 4430
- 9. Light Pink Detail 2155
- 10. Pink Lace and Detail 1753
- 11. Light Pink Detail 2155
- 12. White Detail 0015
- 13. Green Detail 5440
- 14. White Lace and Detail 0015

DESIGNS



Note: Some designs in this collection may have been created using unique special stitches and/or techniques. To preserve design integrity when rescaling or rotating designs in your software, always rescale or rotate designs using the handles directly on-screen.

FABRIC REQUIRED

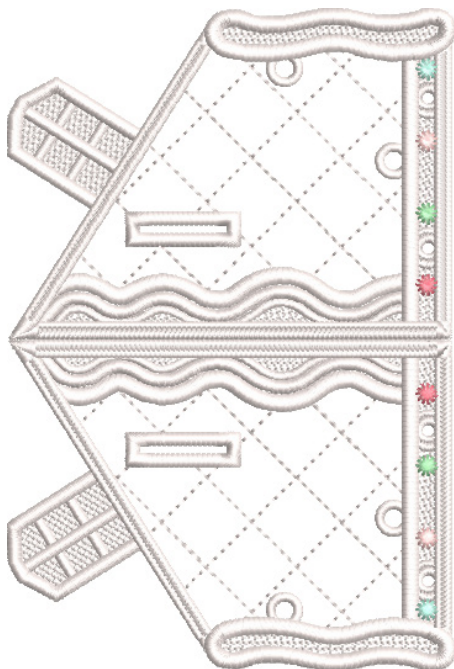

51257-08 Roof 3 FSA

Size Inches: Size mm: Stitch Count:
6.32 X 4.24 in. 160.4 X 107.8 mm 33998 St.

- 1. White Felt Placement Stitch 0015
- 2. Cut Line and Tackdown 0015
- 3. White Lace Fill 0015
- 4. White Lace and Detail 0015
- 5. Pink Dots 1753
- 6. Green Dots 5440
- 7. Light Pink Dots 2155
- 8. Light Blue Dots 4430

FABRIC REQUIRED

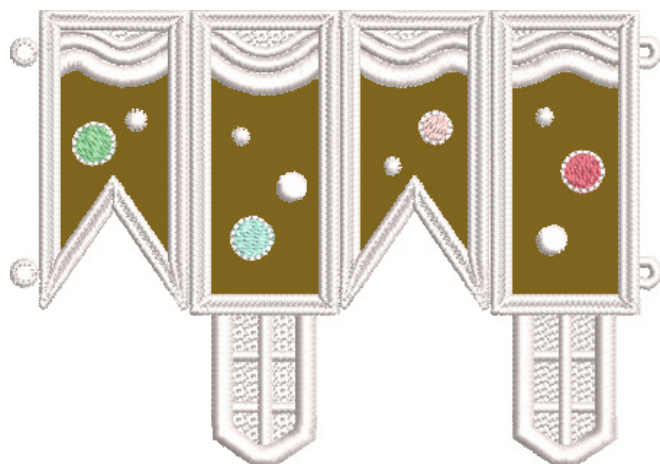

51257-09 Chimney FSA

Size Inches: Size mm: Stitch Count:
3.69 X 5.26 in. 93.7 X 133.6 mm 22502 St.

- 1. Brown Fabric Placement Stitch 0015
- 2. Cut Line and Tackdown 0015
- 3. White Lace 0015
- 4. Green Dot 5440
- 5. Light Blue Dot 4430
- 6. Light Pink Dot 2155
- 7. Pink Dot 1753
- 8. White Detail 0015
- 9. White Lace and Detail 0015

DESIGNS



Note: Some designs in this collection may have been created using unique special stitches and/or techniques. To preserve design integrity when rescaling or rotating designs in your software, always rescale or rotate designs using the handles directly on-screen.

51257-10 Icicles 1 FSL

Size Inches: Size mm: Stitch Count:
4.43 X 4.44 in. 112.6 X 112.7 mm 11621 St.

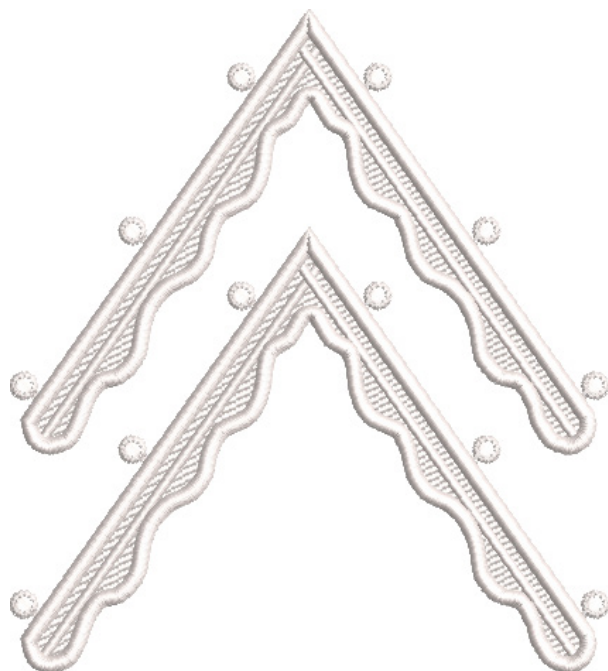

- 1. Bottom Lace Fill..... 0015
- 2. Bottom Lace and Detail..... 0015
- 3. Top Lace Fill..... 0015
- 4. Top Lace and Detail..... 0015

51257-11 Icicles 2 FSL

Size Inches: Size mm: Stitch Count:
2.26 X 3.42 in. 57.3 X 86.9 mm 5144 St.

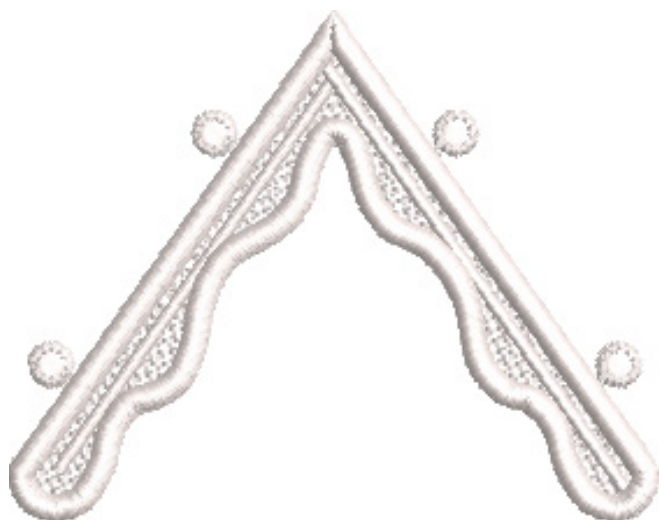

- 1. Lace Fill..... 0015
- 2. Lace and Detail..... 0015

DESIGNS



Note: Some designs in this collection may have been created using unique special stitches and/or techniques. To preserve design integrity when rescaling or rotating designs in your software, always rescale or rotate designs using the handles directly on-screen.

FABRIC REQUIRED

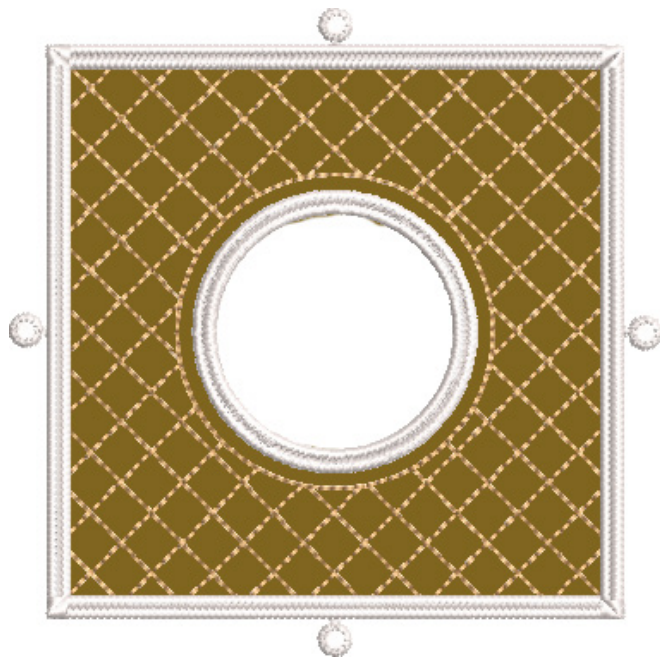

51257-12 Foundation 1 FSA

Size Inches: Size mm: Stitch Count:
5.52 X 4.95 in. 140.2 X 125.8 mm 19288 St.

- 1. Brown Fabric Placement Stitch 1133
- 2. Cut Line and Tackdown 1133
- 3. Tan Detail 1133
- 4. White Lace 0015

FABRIC REQUIRED



51257-13 Foundation 2 FSA

Size Inches: Size mm: Stitch Count:
2.59 X 3.28 in. 65.8 X 83.2 mm 6127 St.

- 1. Brown Fabric Placement Stitch 1133
- 2. Cut Line and Tackdown 1133
- 3. Tan Detail 1133
- 4. White Lace 0015

DESIGNS



Note: Some designs in this collection may have been created using unique special stitches and/or techniques. To preserve design integrity when rescaling or rotating designs in your software, always rescale or rotate designs using the handles directly on-screen.

FABRIC REQUIRED

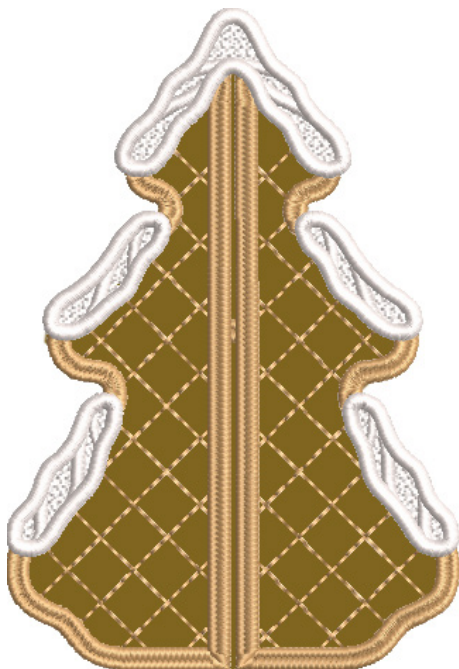

51257-14 Tree Section 1 FSA

Size Inches: Size mm: Stitch Count:
5.53 X 3.75 in. 140.3 X 95.2 mm 17325 St.

- 1. Brown Fabric Placement Stitch 0015
- 2. Cut Line and Tackdown 0015
- 3. Snow Lace Fill 0015
- 4. Tree Lace and Detail 1133
- 5. Snow Lace..... 0015

FABRIC REQUIRED



51257-15 Tree Section 2 FSA

Size Inches: Size mm: Stitch Count:
5.46 X 3.77 in. 138.8 X 95.7 mm 17542 St.

- 1. Brown Fabric Placement Stitch 0015
- 2. Cut Line and Tackdown 0015
- 3. Snow Lace Fill 0015
- 4. Tree Lace and Detail 1133
- 5. Snow Lace..... 0015

DESIGNS



Note: Some designs in this collection may have been created using unique special stitches and/or techniques. To preserve design integrity when rescaling or rotating designs in your software, always rescale or rotate designs using the handles directly on-screen.

51257-16 Small Tree Section 1 FSL

Size Inches: Size mm: Stitch Count:
4.53 X 3.07 in. 115.0 X 78.0 mm 25482 St.

- 1. Tree Lace Fill..... 1133
- 2. Snow Lace Fill..... 0015
- 3. Tree Lace 1133
- 4. Snow Lace..... 0015



51257-17 Small Tree Section 2 FSL

Size Inches: Size mm: Stitch Count:
4.45 X 3.07 in. 113.0 X 78.0 mm 25772 St.

- 1. Tree Lace Fill..... 1133
- 2. Snow Lace Fill..... 0015
- 3. Tree Lace 1133
- 4. Snow Lace..... 0015



MATERIALS



Stabilizers

- OESD AquaMesh WashAway
- OESD BadgeMaster WashAway
- OESD StabilStick CutAway

Fabrics/Textiles

- 1/4 yard tan cotton fabric
- 1 - 9" x 12" sheet white felt
- Note: Fabric sizes are estimates and may result in overage.

Notion & Tools

- OESD Alligator Clamps
- OESD Button Clips
- OESD Perfect Punch Tool
- OESD Perfect Embroidery Press Cloth
- Expert Embroidery Tape WashAway

Isacord Thread Colors

- Per thread chart
- For Cottage - match bobbin thread to top thread on last color change only.
- For Trees - match bobbin thread to top thread on all colors.

SUMMARY



Completed Size: 6.25" x 7.75" x 5.25"

51257-01



Requires 1 Design

51257-02



Requires 1 Design

51257-03



Requires 1 Design

51257-04

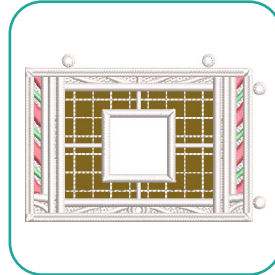

Requires 1 Design

51257-05

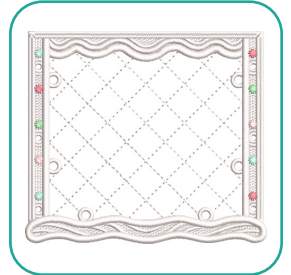

Requires 1 Design

51257-06

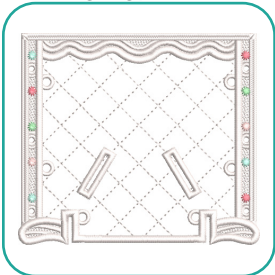

Requires 1 Design

51257-07



Requires 1 Design

51257-08

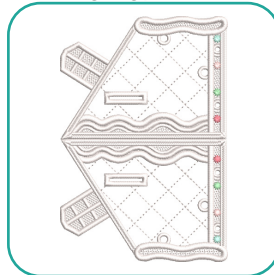

Requires 1 Design

51257-09

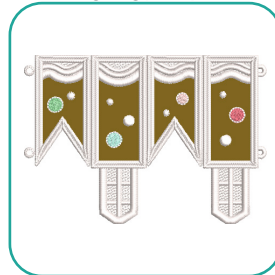

Requires 1 Design

51257-10

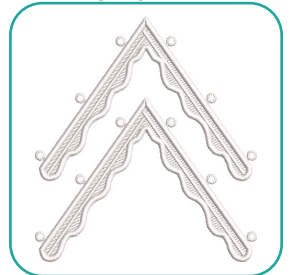

Requires 1 Design

51257-11

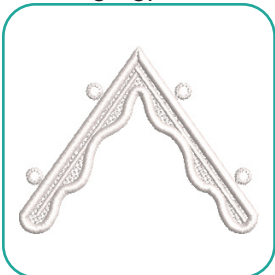

Requires 1 Design

51257-12

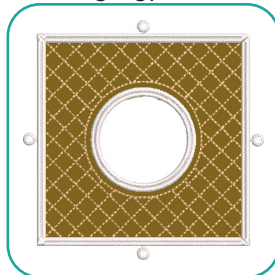

Requires 1 Design

51257-13

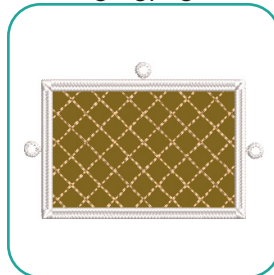

Requires 1 Design

SUMMARY



Completed Size: 4.5" x 3" x 3"



Completed Size: 5.5" x 3.75" x 3.75"

51257-14



Requires 1 Design

51257-15



Requires 1 Design

51257-16



Requires 1 Design

51257-17



Requires 1 Design

Notes

The freestanding applique instructions, included in the collection, are general instructions. For demonstration purposes, a sample design that best demonstrates the technique is shown. Fabric and thread requirements will vary by design, but the general technique is the same.

For Cottage - match bobbin thread to top thread on last color change only.

For Trees - match bobbin thread to top thread on all colors.

Note: Some thread colors in instructions have been changed or digitally enhanced for better visibility.

Step 1

- Adhere two layers of StabilStick CutAway to the wrong side of all applique fabrics to provide stiffness to the finished structure.



Step 2

- Hoop one layer of AquaMesh and one layer of BadgeMaster for all designs.



Step 3

- Stitch Machine Step 1, Brown Fabric Placement Stitch.



Step 4

- Remove the hoop from the machine, but NOT the project from the hoop.
- Place the hoop on a flat surface.
- Completely cover the placement stitch with the prepared fabric.
- Tape in place to secure.

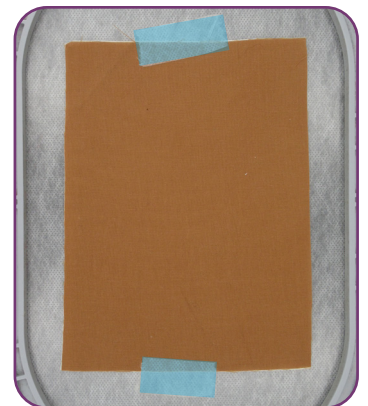

Step 5

- Return the hoop to the machine.
- Stitch Machine Step 2, Cut Line and Tackdown.



Step 6

- Remove the hoop from the machine, but NOT the project from the hoop.
- Trim the excess fabric as close to the cut line stitching as possible. If the outermost stitches are cut, the inner stitches will still hold the applique in place.
- Tip: If the AquaMesh is cut or a hole is created while trimming the fabric, use OESD Expert Embroidery Tape WashAway or AquaMesh Plus as a patch.



Step 7

- Return the hoop to the machine.
- Stitch Machine Step 3, Green Fabric Placement Stitch.



Step 8

- Remove the hoop from the machine, but NOT the project from the hoop.
- Place the hoop on a flat surface.
- Place the prepared applique fabric, right side up, completely covering the placement stitch.
- Tape in place to secure.



Step 9

- Return the hoop to the machine.
- Stitch Machine Step 4, Cut Line and Tackdown.



Step 10

- Remove the hoop from the machine, but NOT the project from the hoop.
- Trim the excess fabric as close to the cut line stitching as possible.



Step 11

- Return the hoop to the machine and stitch the remaining colors according to the thread chart.



Step 12

- When design is complete, remove the project from the hoop and trim the stabilizer 1/4" - 1/2" outside the design.



ASSEMBLY CANDY COTTAGE



Step 13

- Rinse each piece in warm running water until the design is only slightly sticky.
- Lay face down on a non-stick surface to dry. Parchment paper or a cooling rack work well. This prevents the piece from curling.
- When dry, press each piece, right side down, on a Perfect Embroidery Press Cloth.

Step 14

- Before assembly, use a utility knife and cut through all the layers of the tab entry. Take care to not cut the satin stitching.
- Use the Perfect Punch Tool with the 3mm attachment, to punch holes in the eyelets indicated in the cutting guidelines.

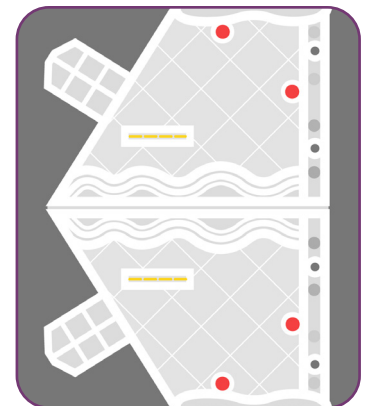
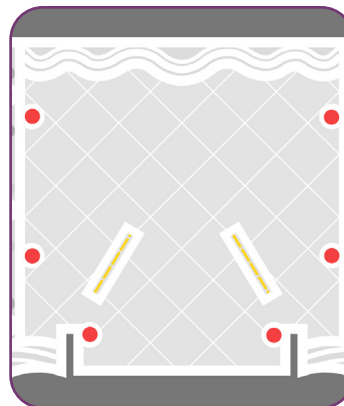

Step 15

- Line up the wall pieces, 51257-01, 51257-02, 51257-03 and 51257-04, to connect.
- Thread the sewing machine with matching thread in the top and bobbin.
- An open toe or edge stitch foot is helpful.
- Stitch together using a multi-step zigzag stitch (also known as a serpentine stitch).
- Back stitch at the beginning and end to secure.
- Trim thread tails.
- Fold and press to shape.



ASSEMBLY CANDY COTTAGE



Step 16

- Match the eyelets and buttonettes on walls 51257-03 to 51257-04. Pull each buttonette through the corresponding eyelet, using button clips to temporarily hold them in place, as needed.



Step 17

- Line up roof pieces 51257-05 and 51257-06 to connect.
- Load the sewing machine with matching thread in the top and bobbin.
- Stitch together using a multi-step zigzag.
- Back stitch at the beginning and end to secure.
- Trim thread tails.



Step 18

- Match the roof eyelets to the buttonettes from 51257-10 Icicles. Pull each buttonette through the corresponding eyelet.

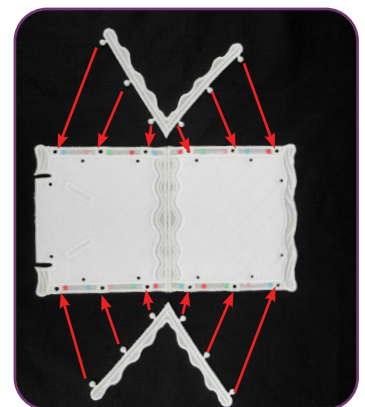

ASSEMBLY CANDY COTTAGE



Step 19

- Match the roof eyelets to the house buttonettes. Pull each buttonette through the corresponding eyelet.

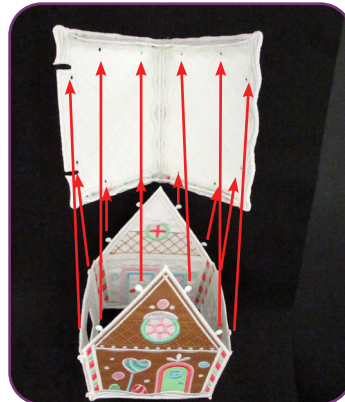

Step 20

- Match the eyelets and buttonettes of the chimney 51257-09. Pull each buttonette through the corresponding eyelet.

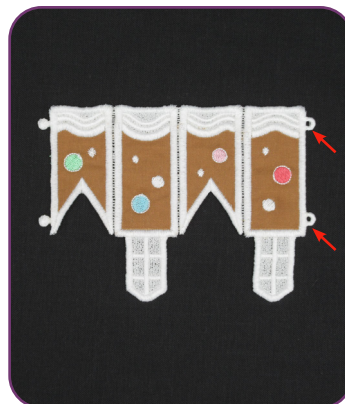

Step 21

- Insert the chimney tabs into the corresponding roof tab entry points.

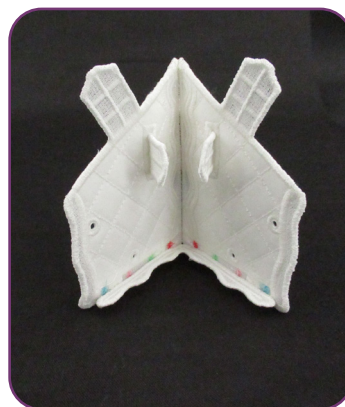

ASSEMBLY CANDY COTTAGE



Step 22

- Match the roof eyelets to the wall buttonettes on 51257-07. Pull each buttonette through the corresponding eyelet.



Step 23

- Insert the tabs into the corresponding tab entry points.

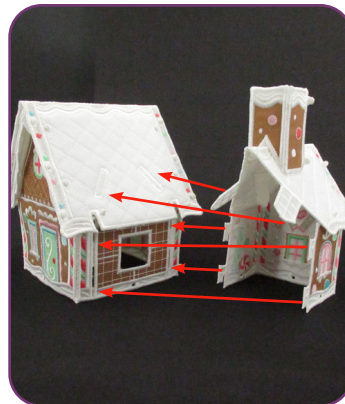

Step 24

- Match the house eyelets to the buttonettes on 51257-12. Pull each buttonette through the corresponding eyelet, using button clips to temporarily hold them in place, as needed.

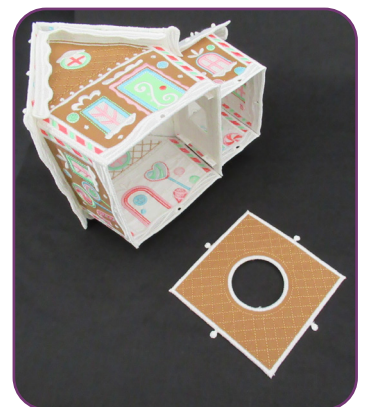

ASSEMBLY CANDY COTTAGE



Step 25

- Match the house eyelets to the buttonettes on 51257-13. Pull each buttonette through the corresponding eyelet, using button clips to temporarily hold them in place, as needed.



Step 26

- Freestanding Candy Cottage is complete.



EMBROIDERY APPLIQUE TREE



Step 1

- Hoop one layer of OESD AquaMesh and one layer of OESD BadgeMaster.



Step 2

- Adhere two layers of StabilStick CutAway to the wrong side of all applique fabrics, to provide stiffness to the finished structure.



Step 3

- Load selected design into the machine.
- Design in the example is 51257-14.
- Thread the machine per the thread chart.
- Stitch Machine Step 1, Brown Fabric Placement Stitch.
- Match the bobbin thread to the upper thread for all colors.



EMBROIDERY APPLIQUE TREE



Step 4

- Remove the hoop from the machine, but NOT the project from the hoop.
- Place the hoop on a flat surface.
- Completely cover the placement stitch with the prepared fabric.
- Tape in place to secure.

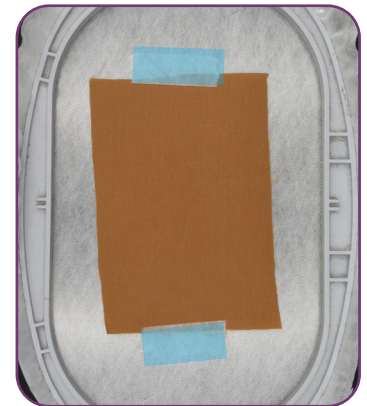

Step 5

- Turn the hoop over and place the fabric, right side up, completely covering the placement stitch.
- Carefully tape to secure. Avoid pushing too hard on the stabilizer to prevent it from dislodging from the hoop.
- Return the hoop to the machine.



Step 6

- Stitch Machine Step 2, Cut Line and Tackdown.



EMBROIDERY APPLIQUE TREE



Step 7

- Remove the hoop from the machine, but NOT the project from the hoop.
- Place the hoop on a flat surface.
- Trim the excess fabric as close to the cut line stitching as possible.

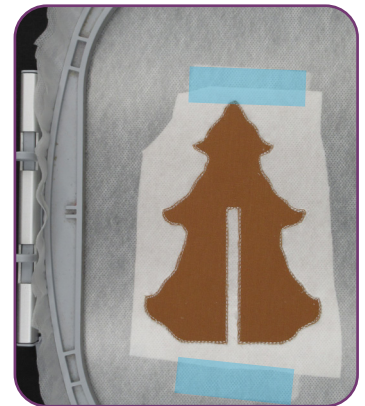

Step 8

- Turn the hoop over and trim the excess fabric as close to the cut line stitching as possible.



Step 9

- Return the hoop to the machine and stitch the remaining steps per the thread chart.
- Remember to match the bobbin thread to the upper thread for all colors.



EMBROIDERY APPLIQUE TREE



Step 10

- When the design is complete, remove the project from the hoop and trim the stabilizer 1/4" - 1/2" outside the design.
- Rinse each piece in warm running water until the design is only slightly tacky.
- Place right side down on a non-stick surface to dry. Parchment paper or a cooling rack work well to prevent curling. Dry completely.
- Once dry, press right side down on a Perfect Embroidery Press Cloth.



ASSEMBLY TREES



Step 11

- Choose the tree upper and corresponding bottom style.
- The Tree Section 1 FSA (51257-14) with the open end on the upper half is the tree bottom.
- The Tree Section 2 FSA (51257-15) with the open end on the lower half is the tree top.

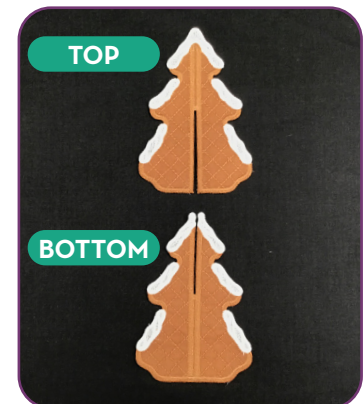

Step 12

- Slide the tree top (51257-15) into the open end of the lower part of the tree (51257-14).



GENERAL FREESTANDING LACE GUIDE



Stabilizer

- OESD AquaMesh
- OESD BadgeMaster

Notion/Tools

- 80/12 Embroidery Ballpoint Titanium needle for extended needle life
- OESD Alligator Clamps
- OESD Button Clips
- OESD Perfect Point and Press Tool

Isacord Thread Colors

- All OESD designs are digitized with Isacord 40 wt. polyester thread as the top thread and in the bobbin.
- Refer to the thread chart for color specifications.
- Match bobbin thread color to the top thread.

Instructions

Step 1 - Hoop

For FSL structures, hoop one layer of OESD AquaMesh and one layer of OESD BadgeMaster. BadgeMaster contains more starch so, combined with the AquaMesh, the lace is more rigid.

For other FSL, where a softer lace is desired, hoop two layers of AquaMesh.

Step 2 - Embroider

Stitch the design per the thread chart with matching thread in the bobbin at each color change.

When complete, remove from the hoop and trim away excess stabilizer about 1/4"-1/2" from the stitching.

Step 3 - Rinse

Rinse remaining stabilizer out in warm running water.

For stiffer lace and FSL structures, DO NOT rinse away all of the stabilizer. The lace should be just slightly tacky.

For softer lace, rinse until all traces of the stabilizer is removed.

Step 4 - Dry

Lay right side down flat on a non-stick surface, such as a cookie rack, parchment paper or Teflon sheet. This minimizes the tendency for the lace to curl.

Let the pieces dry completely before proceeding with any assembly.

Step 5 - Press

Once completely dry, press right side down on a OESD Perfect Embroidery Press Cloth.

Step 6 - Assemble Structure

Note: Specific assembly instructions for a design/collection may be found in the thread chart pdf following the individual design color charts.

Lace must be COMPLETELY DRY before assembly. Wetting the buttonettes or eyelets to assemble is not recommended and may result in them stretching and coming "unbuttoned" when dry.

Use a pair of OESD Alligator Clamps to insert the buttonettes into the eyelets. Insert the tip of the OESD Alligator Clamps into the eyelet, grasp the buttonette and pull through the eyelet. Alternatively, use a stiletto or tweezers to push the buttonette through the eyelet.

Helpful Tips

Limp Lace

If the design is not stiff enough, press the lace pieces on the wrong side while applying spray starch. After ironing, spray again with starch and allow to dry completely. This will stiffen the lace pieces nicely and aid in construction. Or easily re-stiffen by diluting some stabilizer scraps in water (or use liquid starch) and dipping the item in the solution. Lay flat to dry.

Eyelets Too Small

If any of the eyelets appear closed or too small to penetrate with Alligator Clamps, they may be stretched by inserting the small end of the OESD Perfect Point and Press Tool into the eyelet opening and stretching it open wide enough to accommodate the OESD Alligator Clamps.

Button Clips

During the assembly process, some structures pull on buttonettes that have already been inserted and could pull them out altogether. Putting a Button Clip on the assembled buttonette will keep it in position during the assembly process. Remove the Button Clips when the assembly is complete.

Alternative Construction Option

In some cases, the buttonettes may be pulled to the inside of a project, instead of being visible on the outside.

Insert the OESD Alligator Clamps through the eyelet from the wrong, or inside, of the lace and grasp the corresponding buttonette. Pull the buttonette to the wrong side of the lace.

Pulling the buttonettes to the inside may cause stress on the ones already done. Button clips may be placed on the completed buttonette(s) to prevent them from pulling out of the eyelet.

PUNCH TOOL GUIDES



51257-05

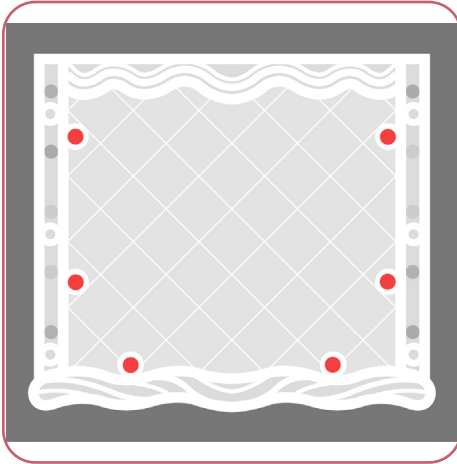

51257-06

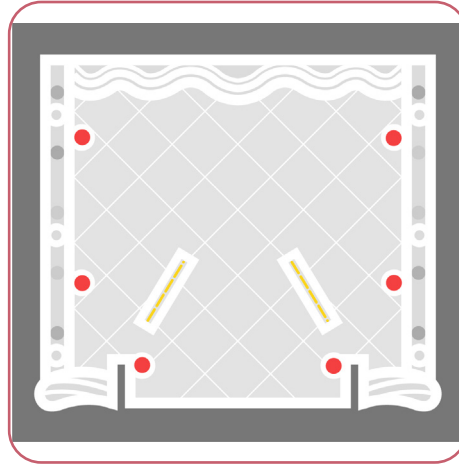

51257-08

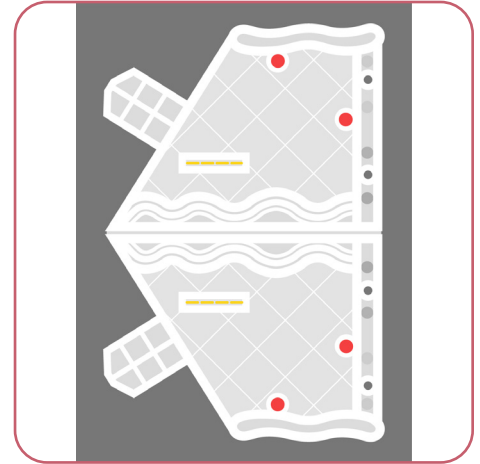

- = 2 MM
- = 3 MM
- = 4 MM

CRAFT KNIFE



PRINTING INSTRUCTIONS



ATTENTION

When printing this document, any page scaling or page fitting options in your print dialog box must be turned OFF or set to NONE so that your files will print out at their actual size. Images not printed at actual size will not function as intended.

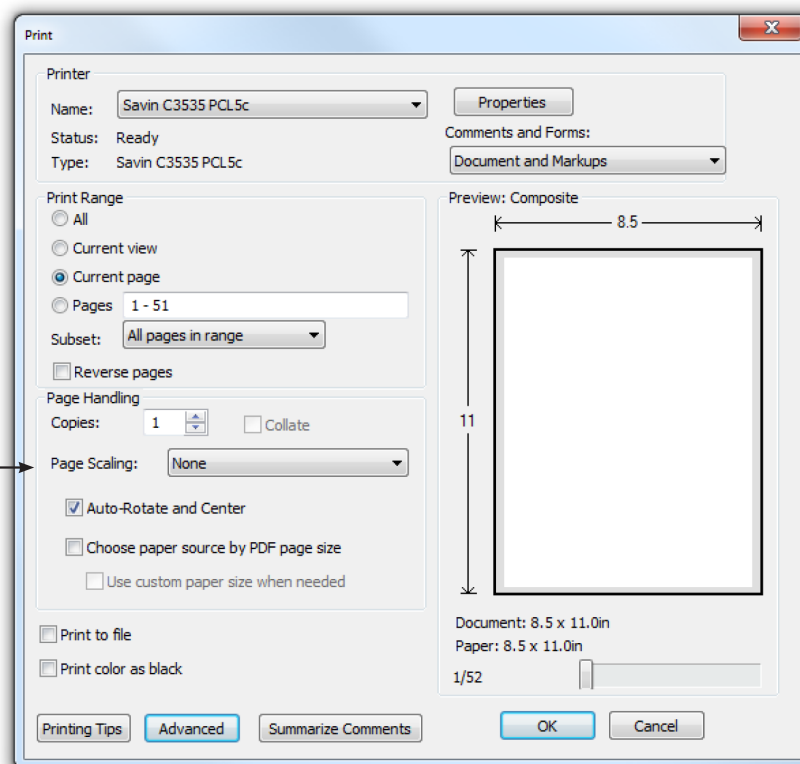

TO SAVE PAPER

Only print the desired image by navigating to the image's page, go to File > Print and select "Current page" in the print dialog box. Repeat for each desired image.

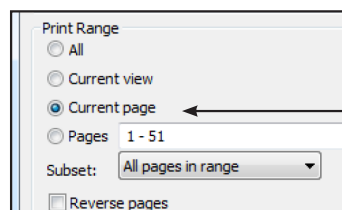

APPLIQUE PATTERNS



Print at 100%. No scaling. This box measures 1" x 1". Use the box as an accuracy guide when printing templates.

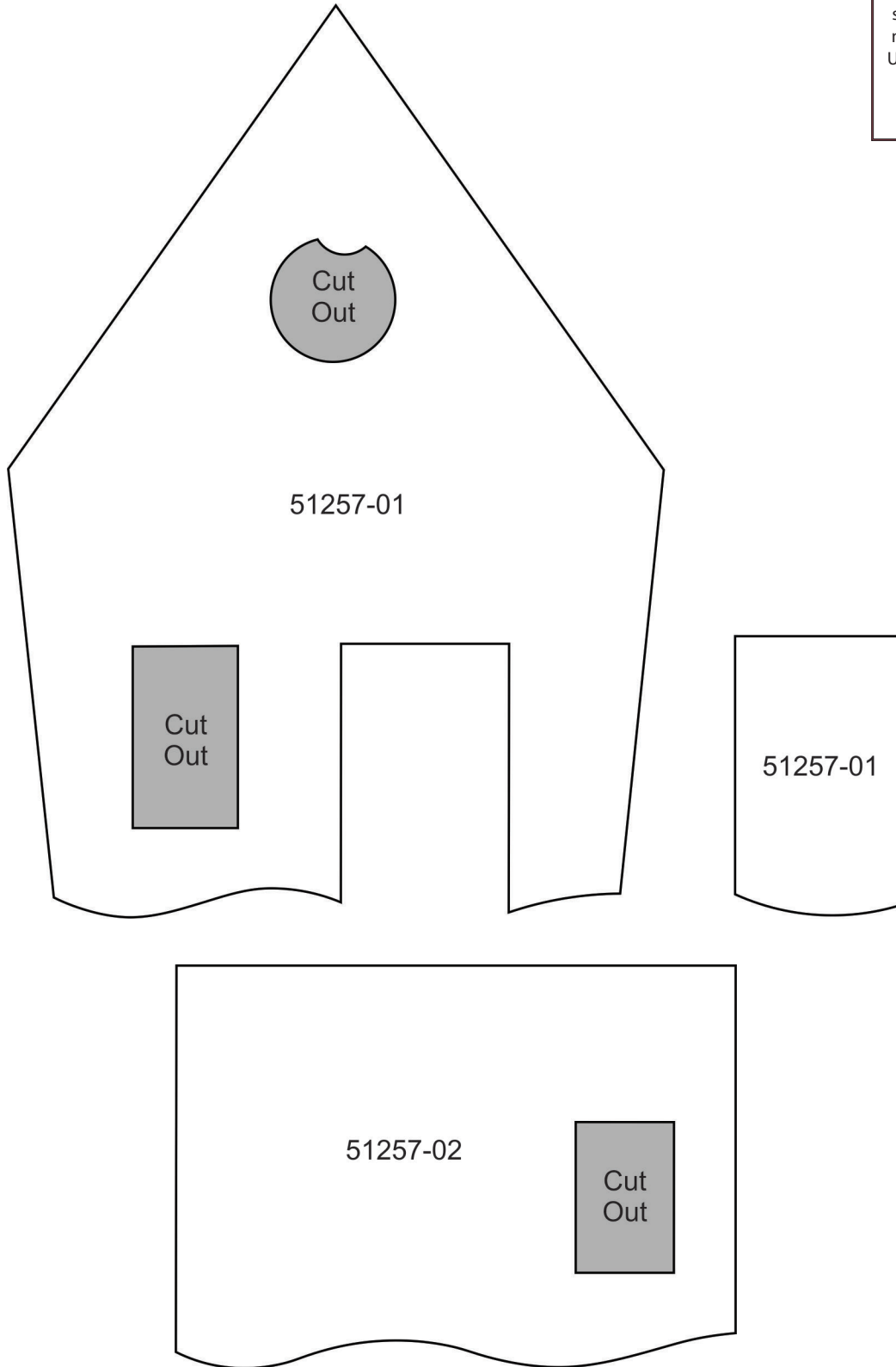

APPLIQUE PATTERNS



Print at 100%. No scaling. This box measures 1" x 1". Use the box as an accuracy guide when printing templates.

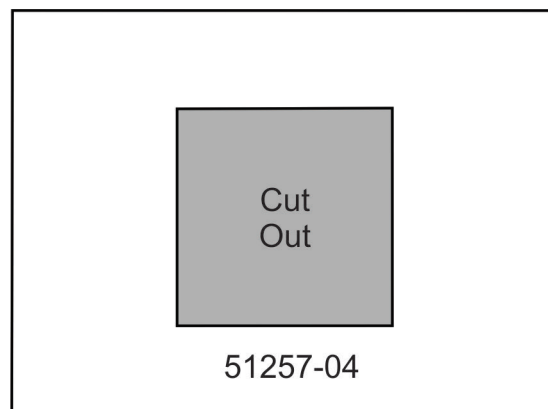
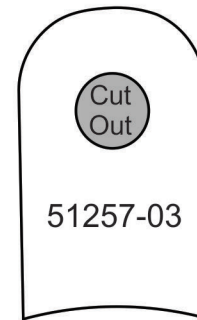
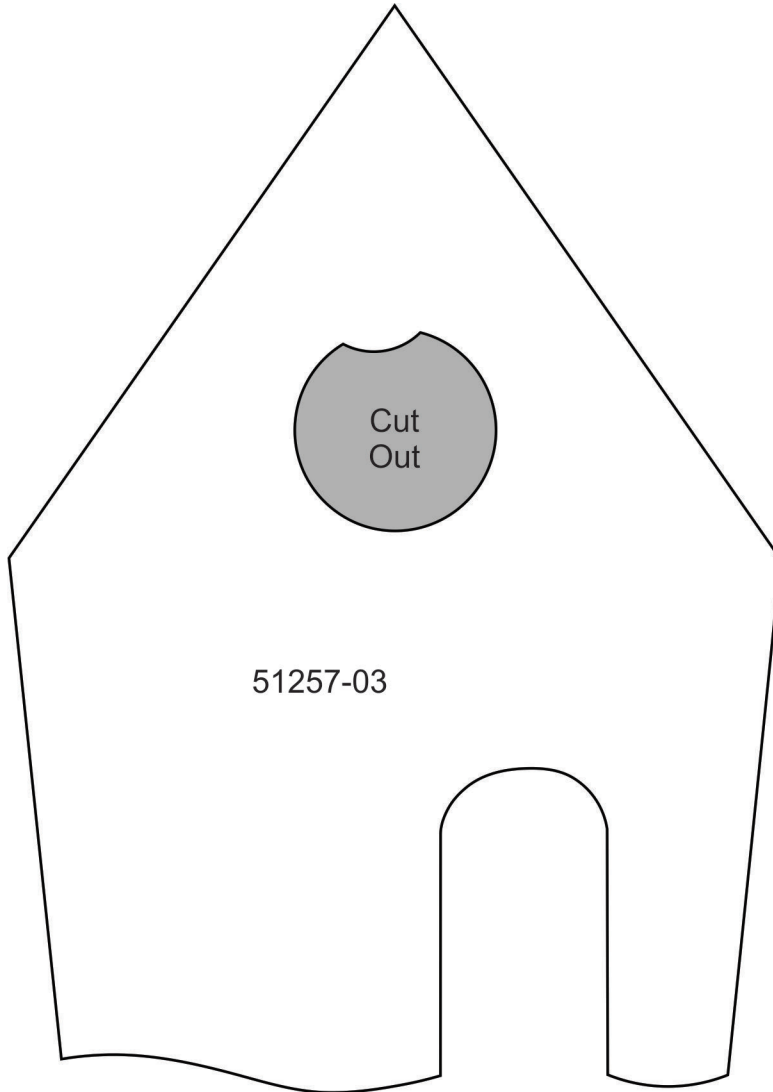

APPLIQUE PATTERNS

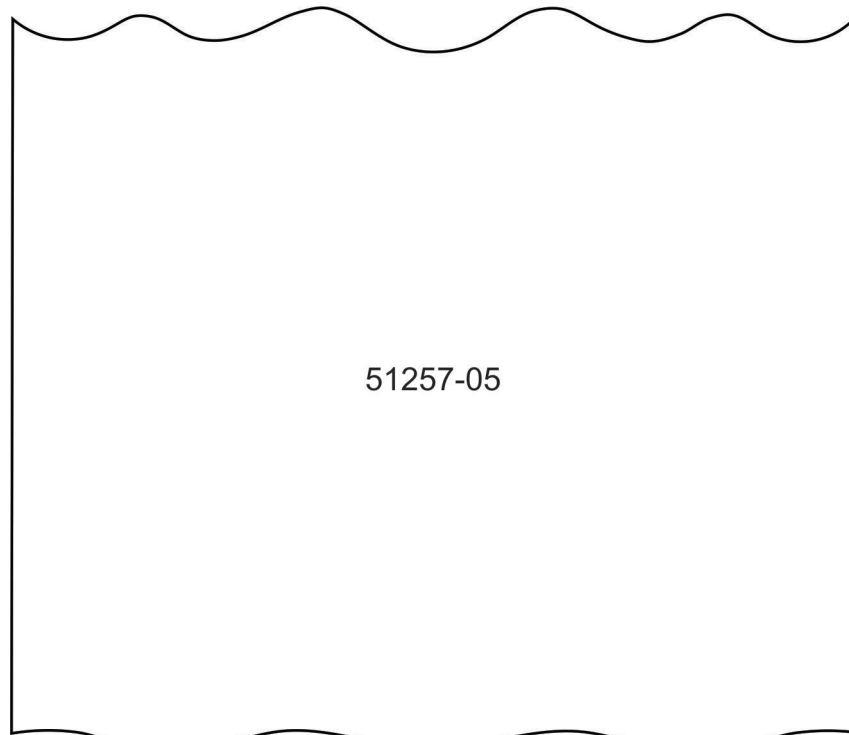

51257-05

Print at 100%. No scaling. This box measures 1" x 1". Use the box as an accuracy guide when printing templates.

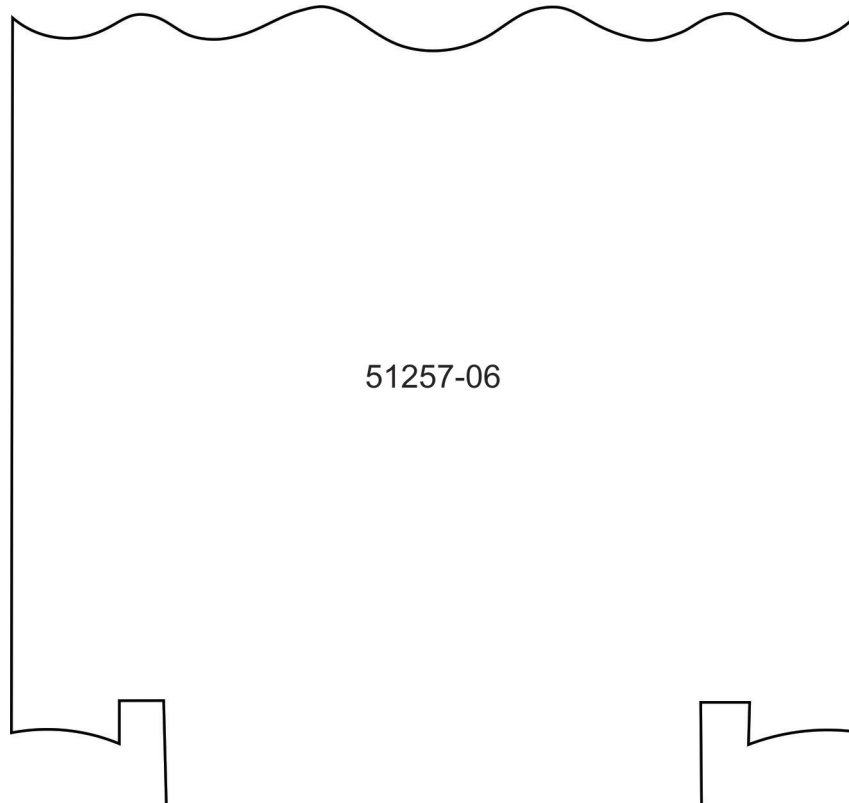

51257-06

APPLIQUE PATTERNS



Print at 100%. No scaling. This box measures 1" x 1". Use the box as an accuracy guide when printing templates.

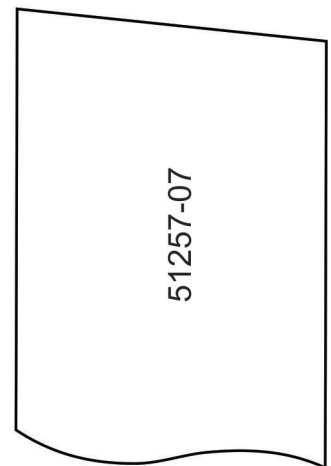
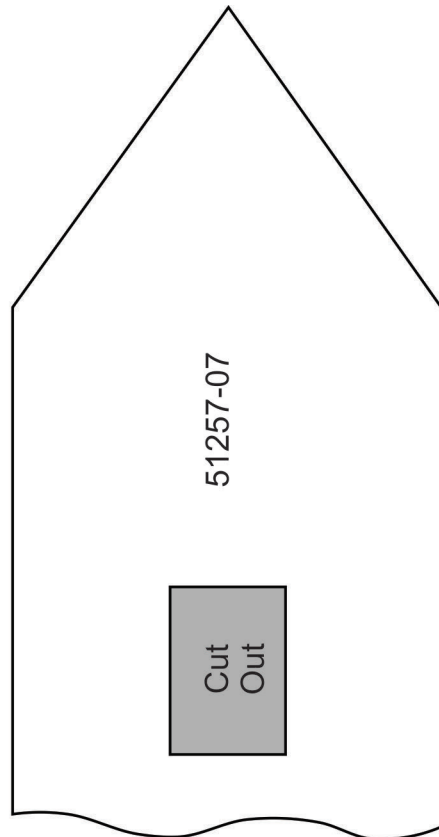
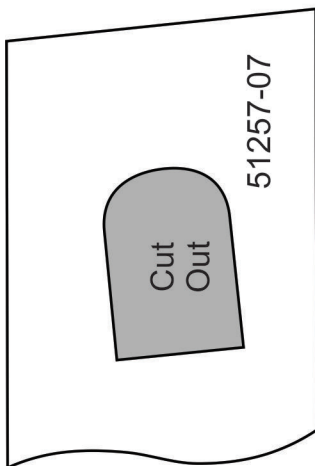
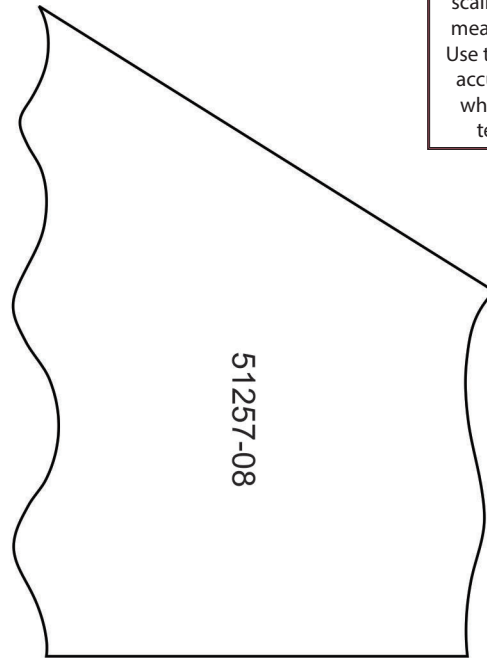
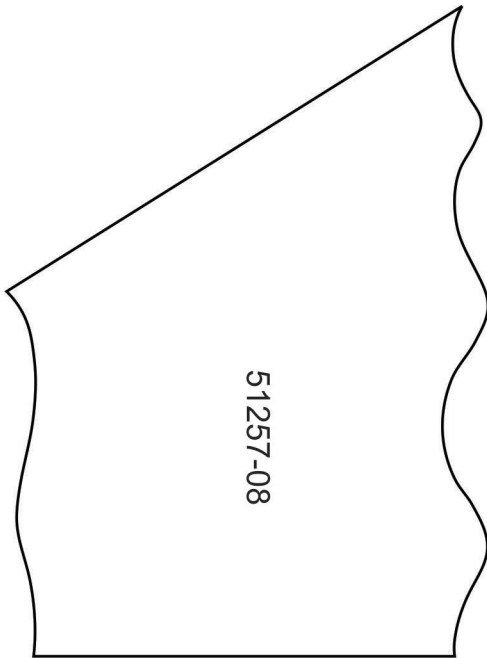

APPLIQUE PATTERNS



Print at 100%. No scaling. This box measures 1" x 1". Use the box as an accuracy guide when printing templates.

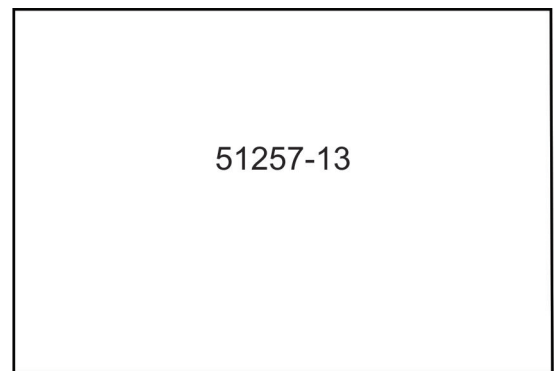
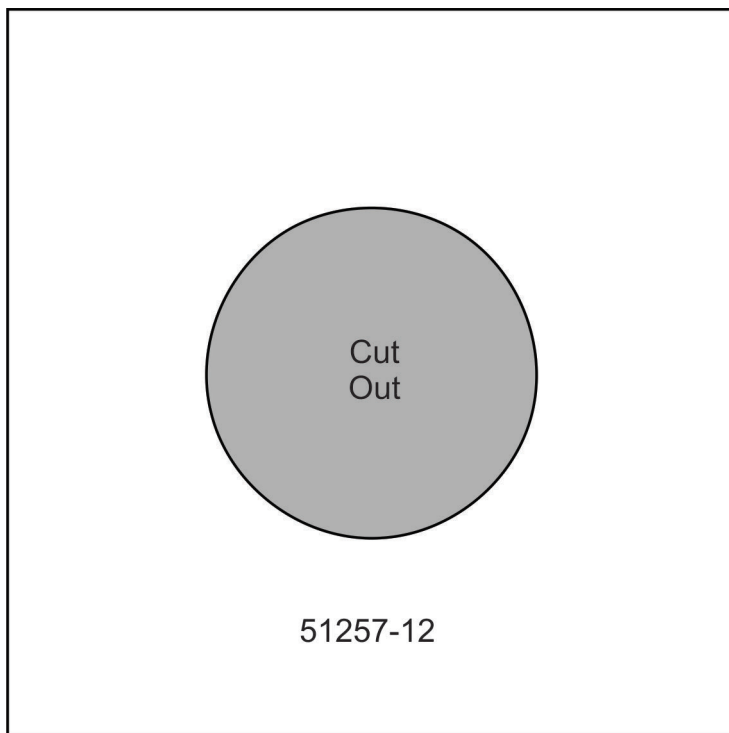
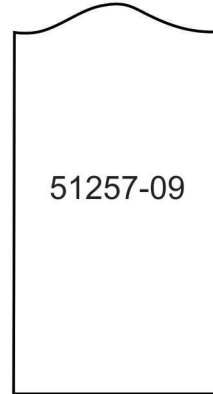
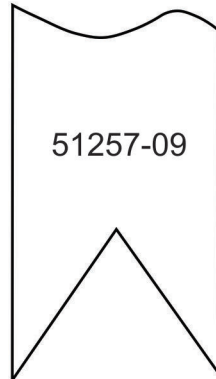
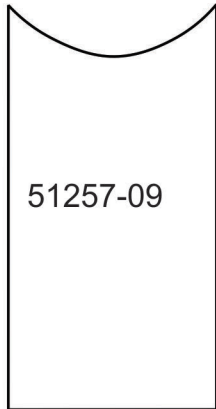

APPLIQUE PATTERNS



Print at 100%. No scaling. This box measures 1" x 1". Use the box as an accuracy guide when printing templates.

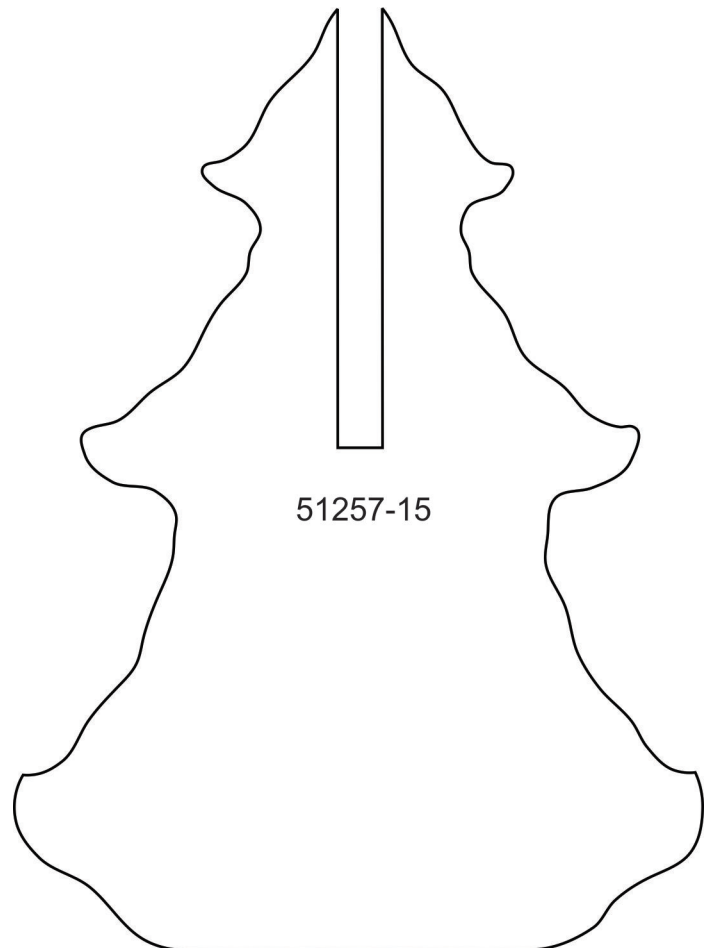
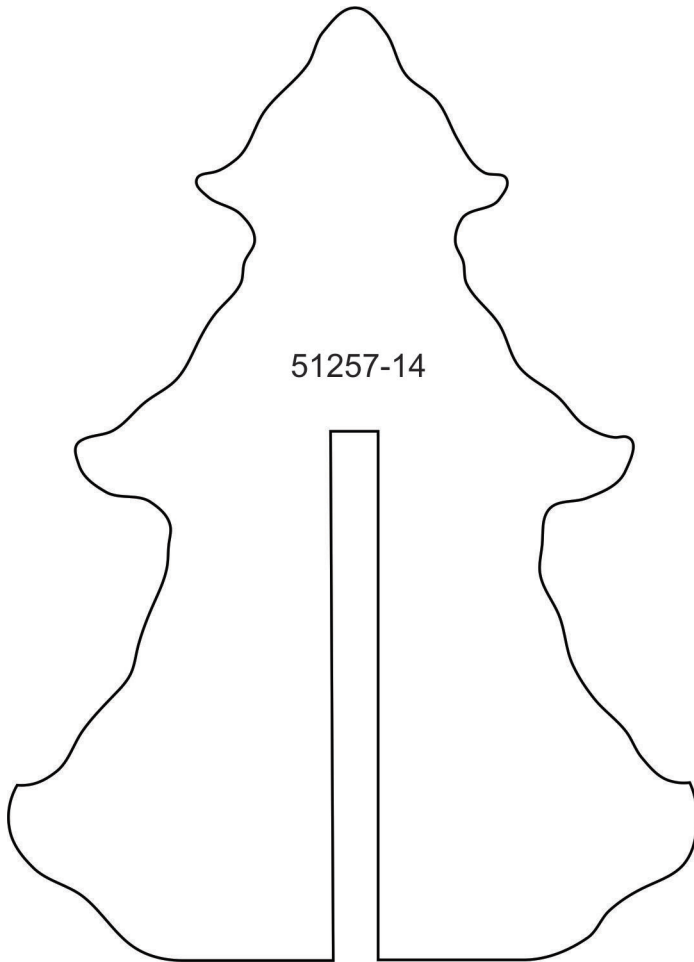

MIRRORED PATTERNS



Print at 100%. No scaling. This box measures 1" x 1". Use the box as an accuracy guide when printing templates.

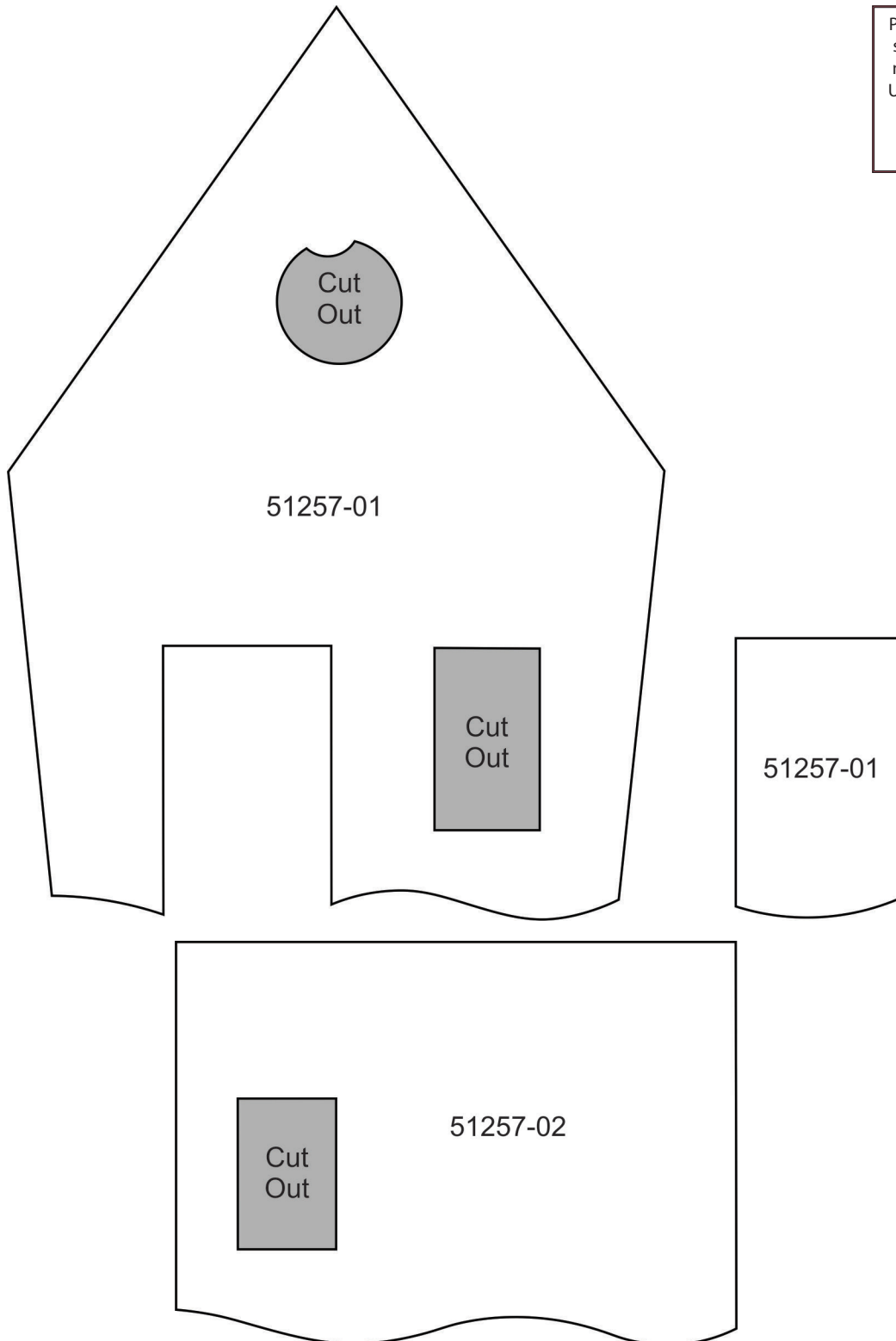

MIRRORED PATTERNS



Print at 100%. No scaling. This box measures 1" x 1". Use the box as an accuracy guide when printing templates.

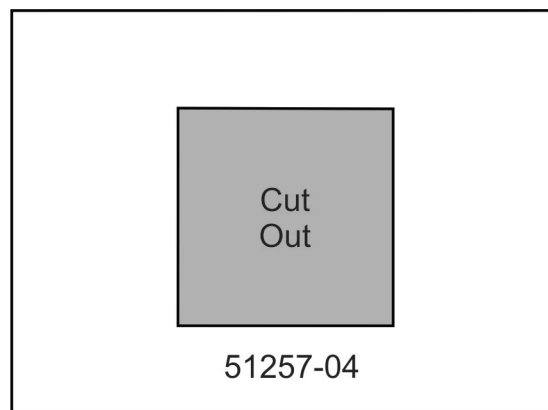
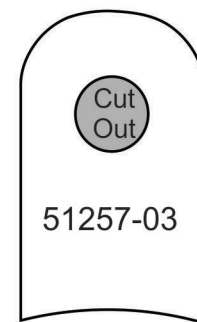
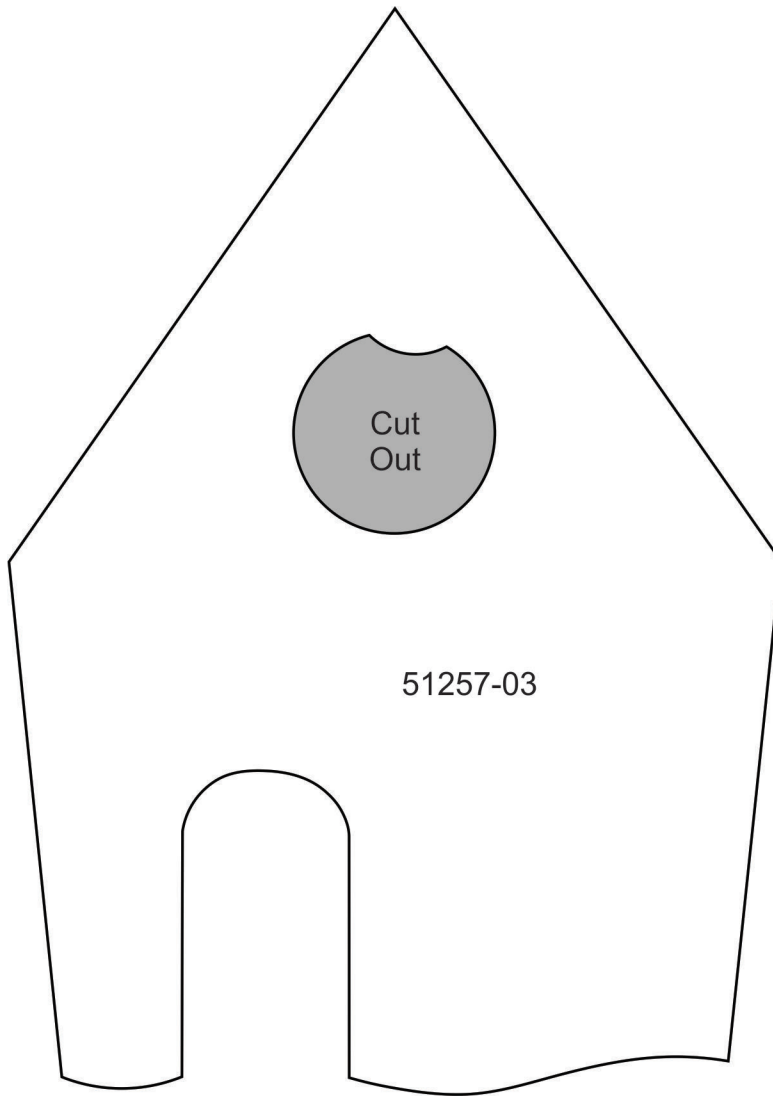

MIRRORED PATTERNS

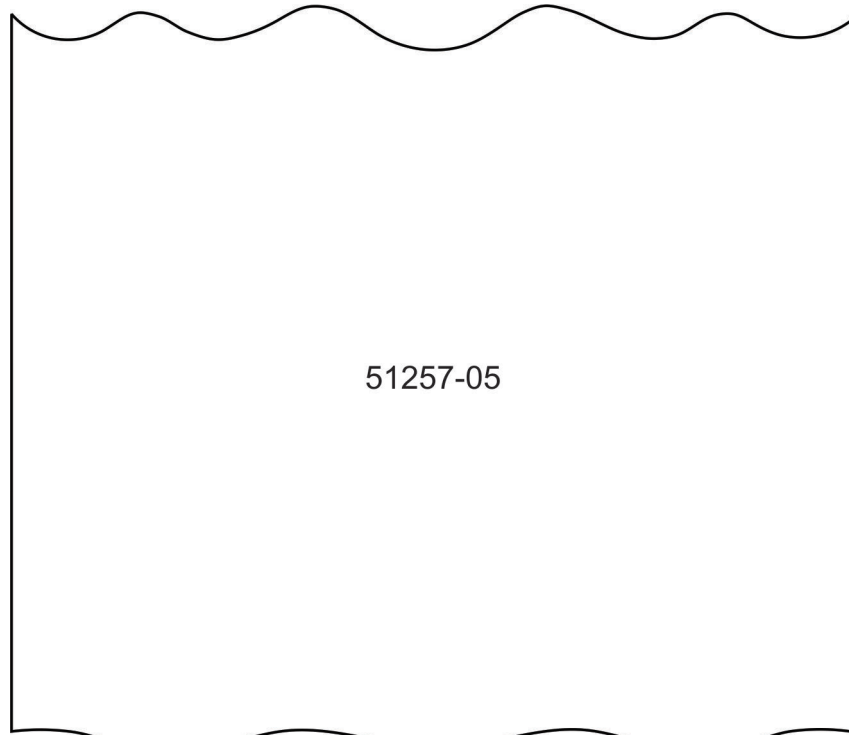

51257-05

Print at 100%. No scaling. This box measures 1" x 1". Use the box as an accuracy guide when printing templates.

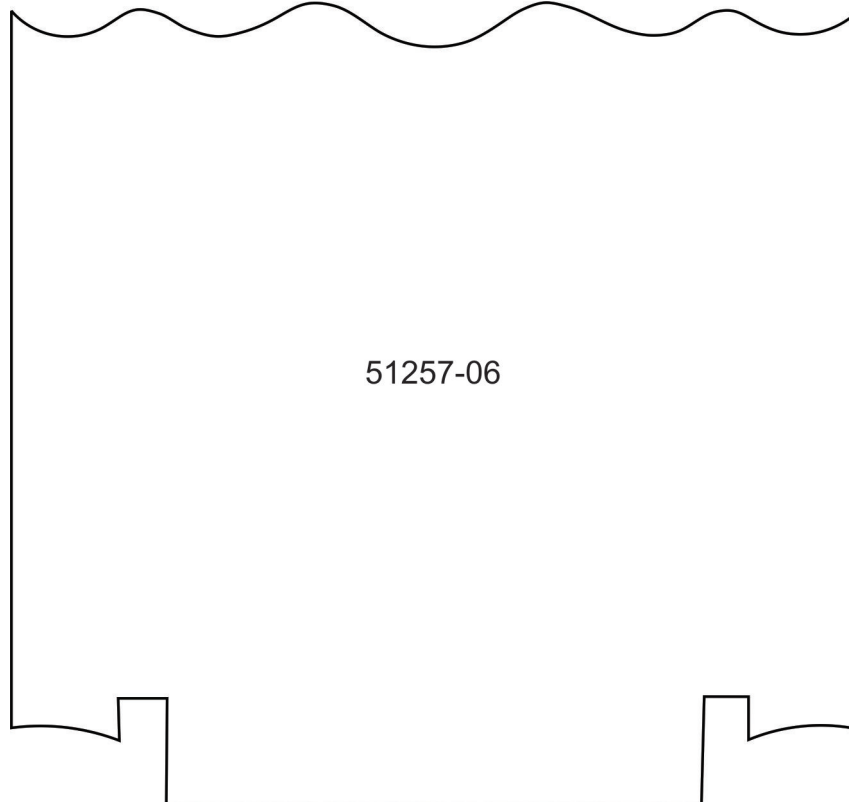

51257-06

MIRRORED PATTERNS



Print at 100%. No scaling. This box measures 1" x 1". Use the box as an accuracy guide when printing templates.

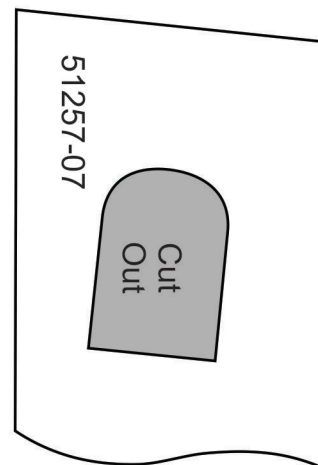
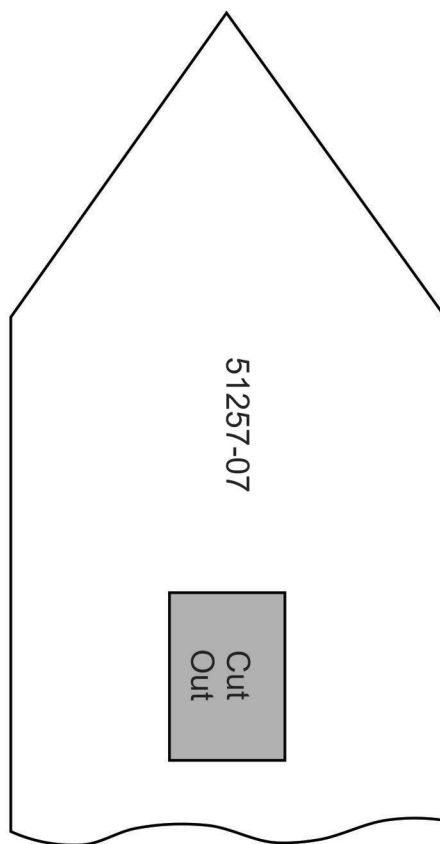
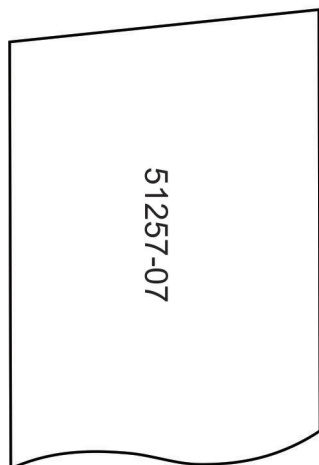
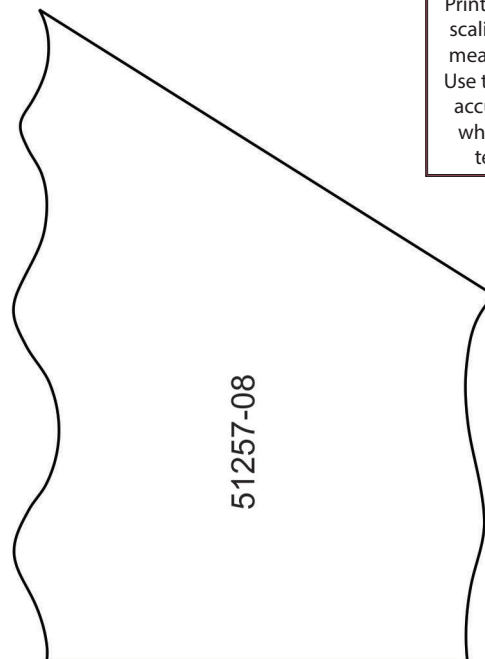
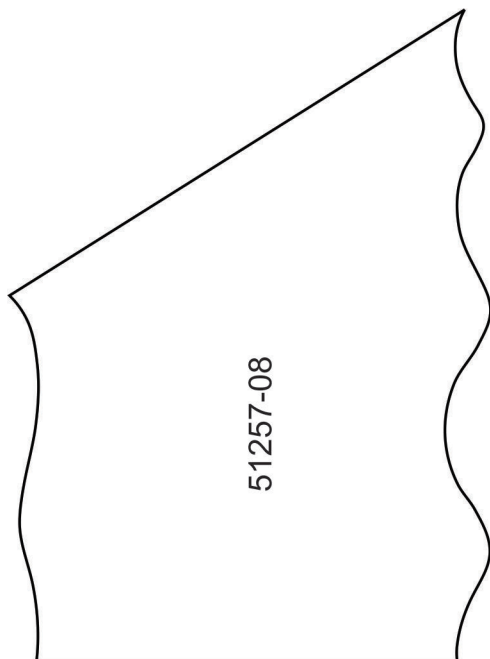

MIRRORED PATTERNS



Print at 100%. No scaling. This box measures 1" x 1". Use the box as an accuracy guide when printing templates.

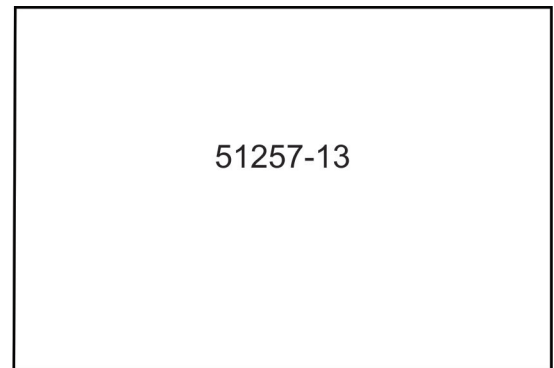
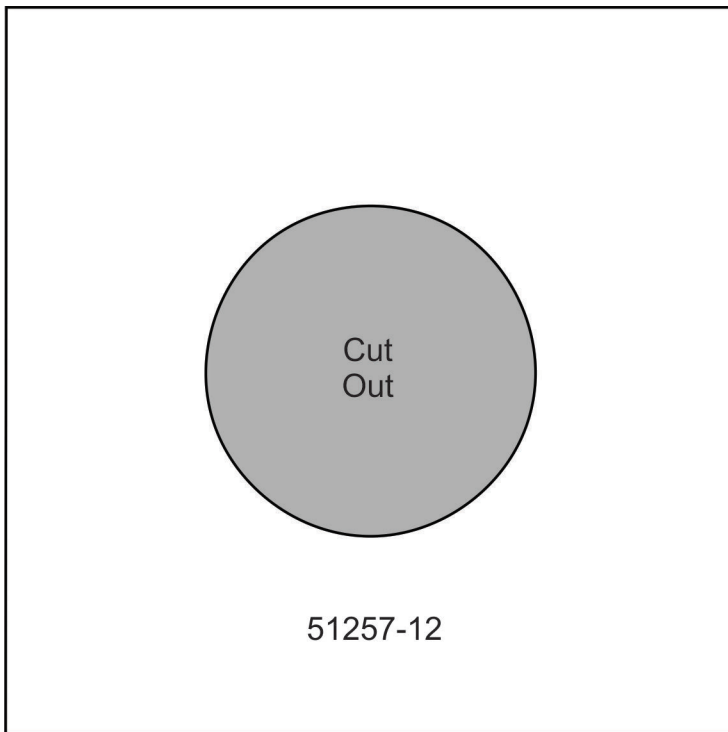
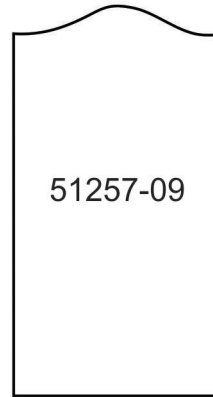
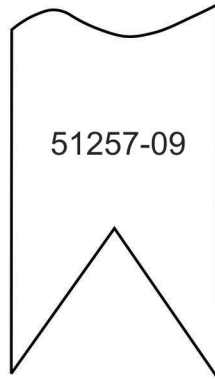
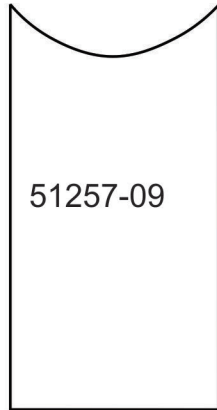
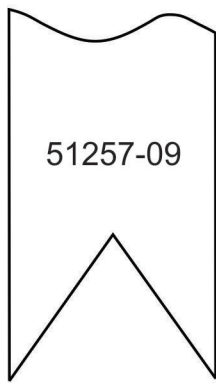

MIRRORED PATTERNS



Print at 100%. No scaling. This box measures 1" x 1". Use the box as an accuracy guide when printing templates.

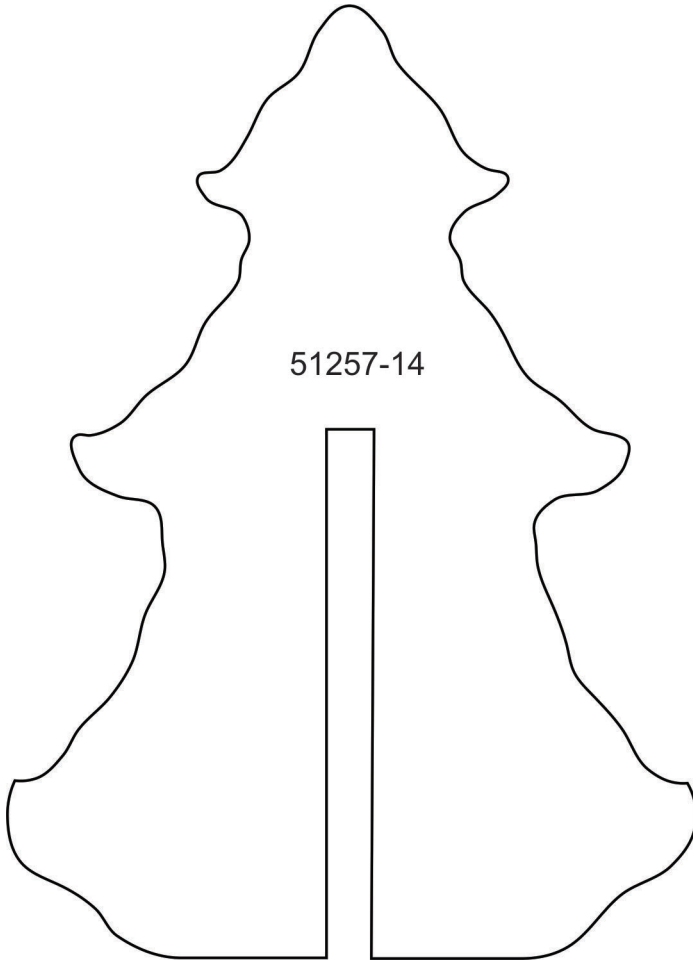

51257-14

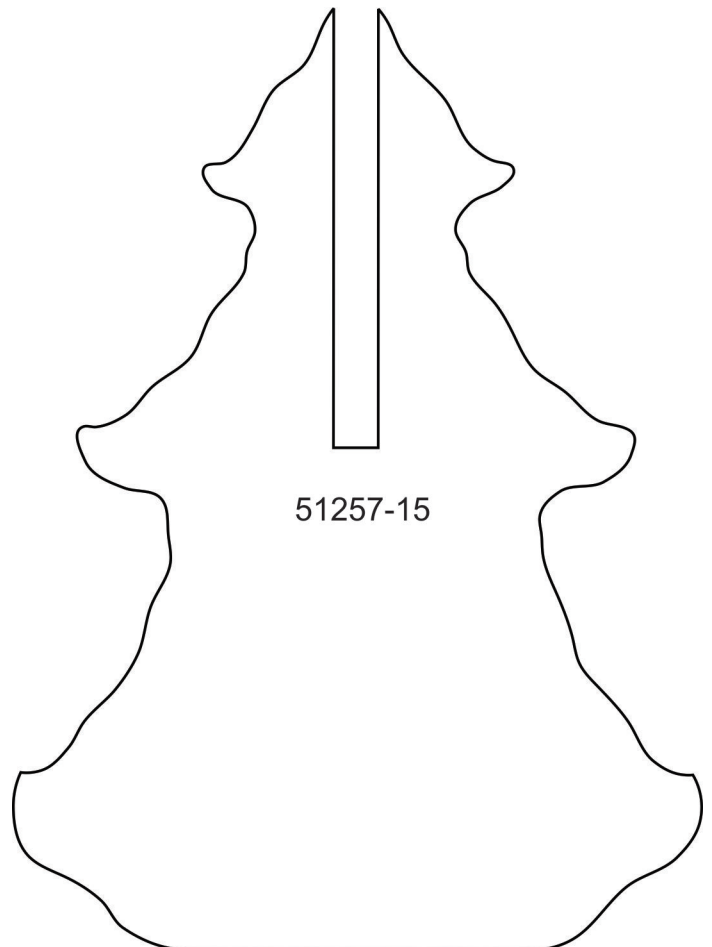

51257-15



#51280
1 DESIGN

Freestanding Cookie Cabin



It is a violation of Copyright law to make and distribute copies of electronic designs or artwork.
Electronic designs are licensed to the original purchaser for use at one location. ©2022 OESD, LLC. All rights reserved.

MATERIALS



Isacord Thread Colors

0015 White - 2 Spools
1141 Tan
1805 Strawberry

2560 Azalea Pink
5440 Mint
5515 Kelly

*** Project instructions included after design list.**

Note: One spool of 1000 meter thread is adequate for the project unless otherwise noted.

Table of Contents

Interactive Menu

Click to Navigate

Designs	03
Collection Supplies	11
Summary	12
Embroidery	13
Freestanding Lace Guide	23
Punch Tool Guide	24
Printing Instructions	25
Applique Patterns	26
Mirrored Patterns	32

DESIGNS



Note: Some designs in this collection may have been created using unique special stitches and/or techniques. To preserve design integrity when rescaling or rotating designs in your software, always rescale or rotate designs using the handles directly on-screen.

FABRIC REQUIRED



51280-01 Back Wall FSA

Size Inches: 5.49 X 4.51 in. Size mm: 139.5 X 114.5 mm Stitch Count: 32676 St.

- 1. Brown Fabric Placement Stitch 0015
- 2. Cut Line and Tackdown 0015
- 3. Red Fabric Placement Stitch 0015
- 4. Cut Line and Tackdown 0015
- 5. White Lace and Detail 0015
- 6. Tan Detail 1141
- 7. Pink Lace and Detail 2560
- 8. Red Lace and Detail 1805
- 9. Mint Lace and Detail 5440
- 10. Green Lace and Detail 5515
- 11. Cover Stitch and Lace Detail 0015

FABRIC REQUIRED



51280-02 Left Wall FSA

Size Inches: 4.49 X 4.80 in. Size mm: 114.0 X 122.0 mm Stitch Count: 38179 St.

- 1. Brown Fabric Placement Stitch 0015
- 2. Cut Line and Tackdown 0015
- 3. White Lace and Detail 0015
- 4. Tan Detail 1141
- 5. Pink Lace and Detail 2560
- 6. Mint Lace and Detail 5440
- 7. Green Lace and Detail 5515
- 8. Red Lace and Detail 1805
- 9. Cover Stitch and Lace Detail 0015

DESIGNS



Note: Some designs in this collection may have been created using unique special stitches and/or techniques. To preserve design integrity when rescaling or rotating designs in your software, always rescale or rotate designs using the handles directly on-screen.

FABRIC REQUIRED

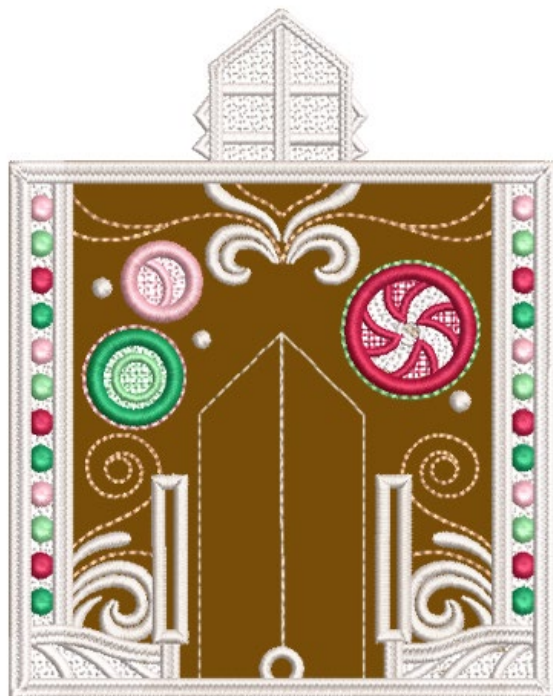

51280-03 Front Wall FSA

Size Inches: Size mm: Stitch Count:
5.49 X 4.34 in. 139.5 X 110.2 mm 27376 St.

- 1. Brown Fabric Placement Stitch 0015
- 2. Cut Line and Tackdown 0015
- 3. White Lace and Detail 0015
- 4. Tan Detail 1141
- 5. Pink Lace and Detail 2560
- 6. Red Lace and Detail 1805
- 7. Mint Lace and Detail 5440
- 8. Green Detail 5515
- 9. Cover Stitch and Lace Detail 0015

FABRIC REQUIRED



51280-04 Right Wall FSA

Size Inches: Size mm: Stitch Count:
4.49 X 5.04 in. 114.0 X 127.9 mm 37392 St.

- 1. Brown Fabric Placement Stitch 0015
- 2. Cut Line and Tackdown 0015
- 3. White Lace and Detail 0015
- 4. Tan Detail 1141
- 5. Pink Lace and Detail 2560
- 6. Mint Lace and Detail 5440
- 7. Green Lace and Detail 5515
- 8. Red Lace and Detail 1805
- 9. Cover Stitch and Lace Detail 0015

DESIGNS



Note: Some designs in this collection may have been created using unique special stitches and/or techniques. To preserve design integrity when rescaling or rotating designs in your software, always rescale or rotate designs using the handles directly on-screen.

FABRIC REQUIRED

51280-05 Front Door FSA



Size Inches: Size mm: Stitch Count:
3.49 X 5.30 in. **88.7 X 134.7 mm** **21126 St.**

- 1. Brown Fabric Placement Stitch 0015
- 2. Cut Line and Tackdown 0015
- 3. Red Fabric Placement Stitch 0015
- 4. Cut Line and Tackdown 0015
- 5. White Lace and Detail 0015
- 6. Tan Detail 1141
- 7. Pink Lace and Detail 2560
- 8. Red Lace and Detail 1805
- 9. Green Lace and Detail 5515
- 10. Mint Lace and Detail..... 5440
- 11. Cover Stitch and Lace Detail..... 0015

51280-06 Front Door Roof FSL

Size Inches: Size mm: Stitch Count:
0.96 X 3.76 in. **24.4 X 95.5 mm** **7539 St.**

- 1. Single Color Design..... 0015

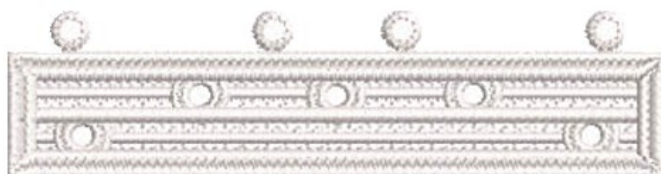

DESIGNS



Note: Some designs in this collection may have been created using unique special stitches and/or techniques. To preserve design integrity when rescaling or rotating designs in your software, always rescale or rotate designs using the handles directly on-screen.

51280-07 Front Door Snow FSL

Size Inches: Size mm: Stitch Count:
1.67 X 2.62 in. 42.4 X 66.5 mm 5835 St.

- 1. Single Color Design..... 0015



FABRIC REQUIRED

51280-08 Attic Floor FSA

Size Inches: Size mm: Stitch Count:
5.21 X 4.86 in. 132.4 X 123.5 mm 12880 St.

- 1. Brown Fabric Placement Stitch 0015
- 2. Cut Line and Tackdown 0015
- 3. Cover Stitch and Detail..... 0015

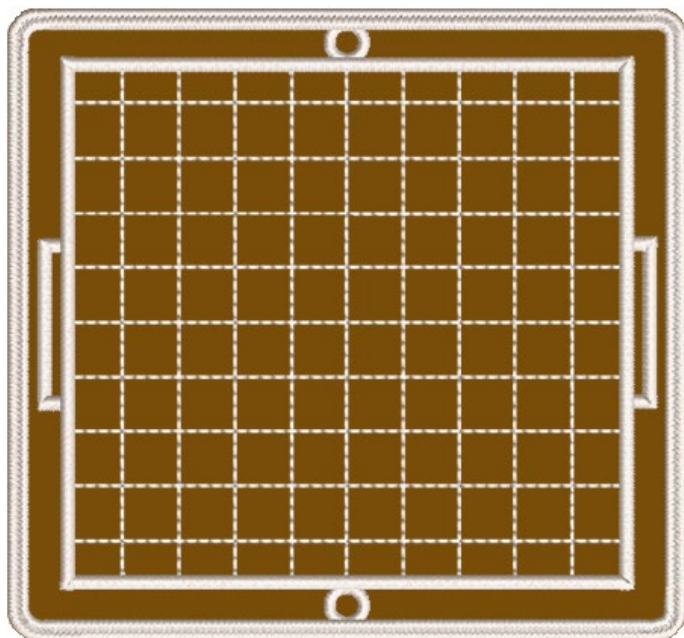

DESIGNS



Note: Some designs in this collection may have been created using unique special stitches and/or techniques. To preserve design integrity when rescaling or rotating designs in your software, always rescale or rotate designs using the handles directly on-screen.

FABRIC REQUIRED

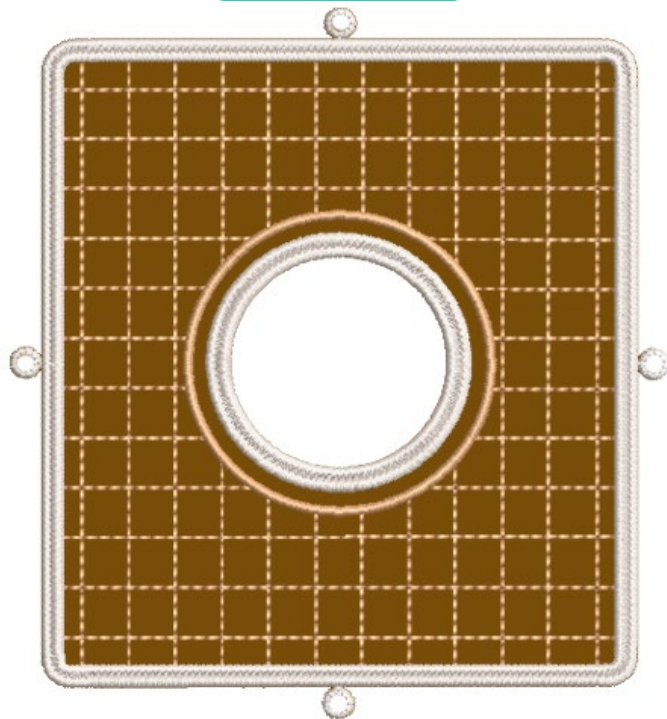

51280-09 Foundation FSA

Size Inches: Size mm: Stitch Count:
5.27 X 4.79 in. **133.9 X 121.8 mm** **12069 St.**

- 1. Brown Fabric Placement Stitch 1141
- 2. Cut Line and Tackdown 1141
- 3. Tan Detail 1141
- 4. Cover Stitch and Lace Detail 0015

FABRIC REQUIRED



51280-10 Roof 1 FSA

Size Inches: Size mm: Stitch Count:
6.51 X 4.62 in. **165.4 X 117.5 mm** **42150 St.**

- 1. Brown Fabric Placement Stitch 1141
- 2. Cut Line and Tackdown 1141
- 3. Tan Detail 1141
- 4. White Lace and Detail 0015
- 5. Mint Lace and Detail 5440
- 6. Green Lace and Detail 5515
- 7. Red Lace and Detail 1805
- 8. Pink Detail 2560
- 9. Cover Stitch and Lace Detail 0015

DESIGNS



Note: Some designs in this collection may have been created using unique special stitches and/or techniques. To preserve design integrity when rescaling or rotating designs in your software, always rescale or rotate designs using the handles directly on-screen.

FABRIC REQUIRED

51280-11 Roof 2 FSA

Size Inches: Size mm: Stitch Count:
6.51 X 4.62 in. 165.4 X 117.5 mm 44698 St.

- 1. Brown Fabric Placement Stitch 1141
- 2. Cut Line and Tackdown 1141
- 3. Tan Detail 1141
- 4. White Lace and Detail 0015
- 5. Pink Lace and Detail 2560
- 6. Red Lace and Detail 1805
- 7. Mint Lace and Detail 5440
- 8. Green Detail 5515
- 9. Cover Stitch and Lace Detail 0015



FABRIC REQUIRED

51280-12 Front Gable FSA

Size Inches: Size mm: Stitch Count:
3.58 X 5.08 in. 91.0 X 128.9 mm 17841 St.

- 1. Brown Fabric Placement Stitch 0015
- 2. Cut Line and Tackdown 0015
- 3. White Detail 0015
- 4. Tan Detail 1141
- 5. Pink Lace and Detail 2560
- 6. Mint Lace and Detail 5440
- 7. Green Lace and Detail 5515
- 8. Red Detail 1805
- 9. Cover Stitch and Lace Detail 0015



DESIGNS



Note: Some designs in this collection may have been created using unique special stitches and/or techniques. To preserve design integrity when rescaling or rotating designs in your software, always rescale or rotate designs using the handles directly on-screen.

FABRIC REQUIRED

51280-13 Back Gable FSA

Size Inches:	Size mm:	Stitch Count:
3.58 X 5.08 in.	91.0 X 128.9 mm	18081 St.

- 1. Brown Fabric Placement Stitch 0015
- 2. Cut Line and Tackdown 0015
- 3. White Detail 0015
- 4. Tan Detail 1141
- 5. Pink Lace and Detail 2560
- 6. Red Lace and Detail 1805
- 7. Mint Detail 5440
- 8. Cover Stitch and Lace Detail 0015



51280-14 Roof Snow 1 FSL

Size Inches:	Size mm:	Stitch Count:
5.69 X 3.78 in.	144.6 X 95.9 mm	15436 St.

- 1. White Lace and Detail 0015
- 2. Red Lace Detail 1805
- 3. Mint Lace Detail 5440
- 4. Pink Lace Detail 2560

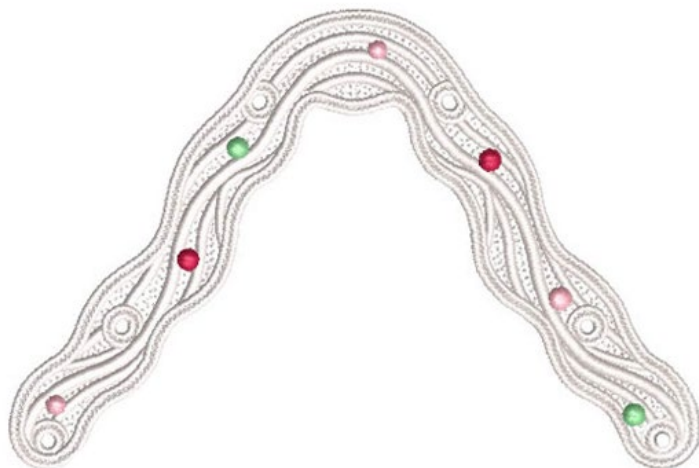

DESIGNS



Note: Some designs in this collection may have been created using unique special stitches and/or techniques. To preserve design integrity when rescaling or rotating designs in your software, always rescale or rotate designs using the handles directly on-screen.

51280-15 Roof Snow 2 FSL

Size Inches: Size mm: Stitch Count:
5.69 X 3.77 in. 144.6 X 95.7 mm 15398 St.

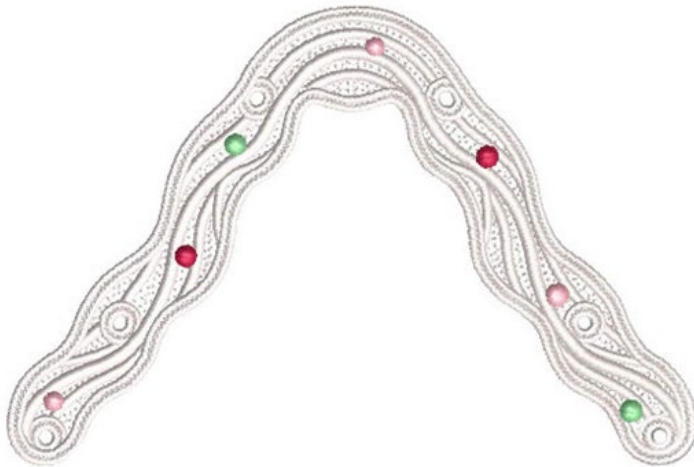

- 1. White Lace and Detail 0015
- 2. Red Lace Detail 1805
- 3. Mint Lace Detail 5440
- 4. Pink Lace Detail 2560

MATERIALS



Stabilizers

- OESD AquaMesh WashAway
- OESD BadgeMaster WashAway
- OESD StabilStick CutAway

Fabrics/Textiles

- Brown quilter's cotton 1/4 yard
- Red quilter's cotton 5" x 5"
- **Note:** Fabric sizes are estimates and may result in overage.

Notion & Tools

- OESD Alligator Clamps
- OESD Button Clips
- OESD Expert Embroidery Tape WashAway
- OESD Expert Embroidery Tape TearAway
- OESD Perfect Punch Tool
- OESD Perfect Embroidery Press Cloth
- Embroidery Needle Sharp 75/11

Isacord Thread Colors

- Per thread chart
- Match the bobbin thread to the upper thread.

SUMMARY



Completed Size: 7.25" H x 4.25" W x 5.5" D

51280-01



Requires 1 Design

51280-02



Requires 1 Design

51280-03



Requires 1 Design

51280-04



Requires 1 Design

51280-05



Requires 1 Design

51280-06



Requires 1 Design

51280-07



Requires 1 Design

51280-08

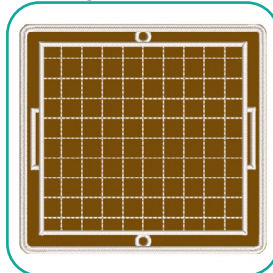

Requires 1 Design

51280-09

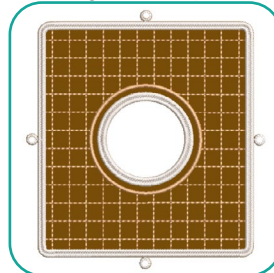

Requires 1 Design

51280-10

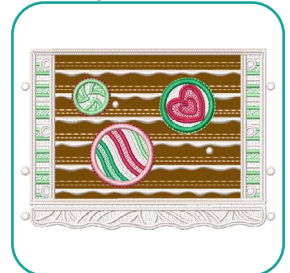

Requires 1 Design

51280-11



Requires 1 Design

51280-12



Requires 1 Design

51280-13



Requires 1 Design

51280-14

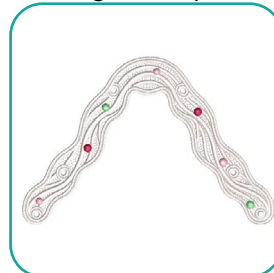

Requires 1 Design

51280-15

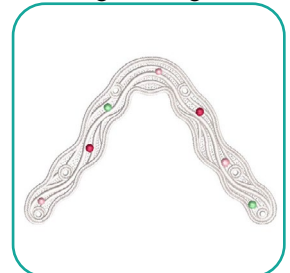

Requires 1 Design

EMBROIDERY



General Instructions

The freestanding applique instructions, included in the collection, are general instructions. For demonstration purposes, a sample design that best demonstrates the technique is shown. Fabric and thread requirements will vary by design, but the general technique is the same.

All designs are stitched with matching thread, top and bobbin.

Note: Some thread colors in instructions have been changed or digitally enhanced for better visibility.

□ Step 1

- Hoop one layer of AquaMesh and one layer of BadgeMaster for all designs.



□ Step 2

- Adhere two layers of StabilStick CutAway to the wrong side of all applique fabrics, to provide stiffness to the finished structure.
- Cut the prepared applique fabrics 1/4" -1/2" larger than the templates that are included at the end of the instructions.



EMBROIDERY



Step 3

- Load selected design into the machine.
- Example design is 51280-05.
- Thread the machine per the thread chart.
- Place hoop on the machine.
- Stitch Machine Step 1, Brown Fabric Placement Stitch.

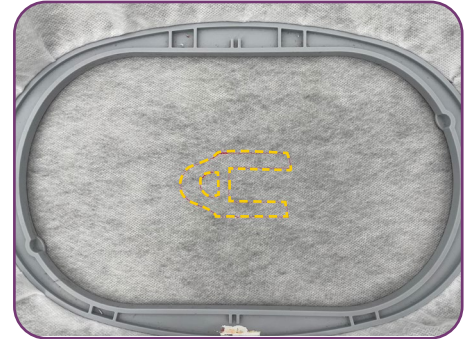

Step 4

- Remove the hoop from the machine, but NOT the project from the hoop.
- Place the hoop on a flat surface.
- Completely cover the placement stitch with the prepared fabric.
- Tape in place to secure.

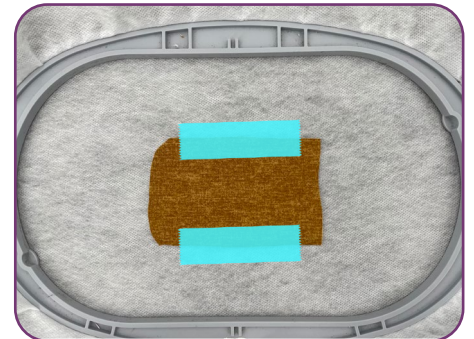

Step 5

- Return the hoop to the machine.
- Stitch Machine Step 2, Cut Line and Tackdown.

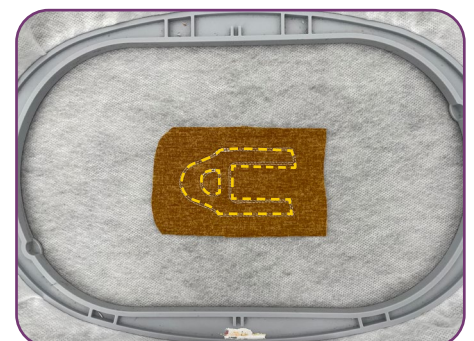

EMBROIDERY



□ Step 6

- Remove the hoop from the machine, but NOT the project from the hoop.
- Trim the excess fabric as close to the cut line as possible. If the outermost stitches (cut line) are cut, the inner stitches (tackdown) will hold the applique in place.
- Tip: If the stabilizer is cut or a hole is created while trimming the fabric, use OESD Expert Embroidery Tape WashAway as a patch.



□ Step 7

- Return the hoop to the machine.
- Stitch Machine Step 3, Red Placement Stitch.

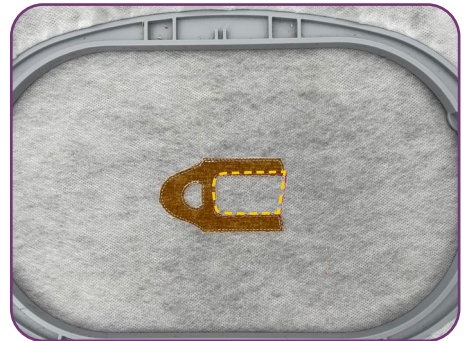

□ Step 8

- Remove the hoop from the machine, but NOT the project from the hoop.
- Place the hoop on a flat surface.
- Completely cover the placement stitch with the prepared fabric.
- Tape in place to secure.

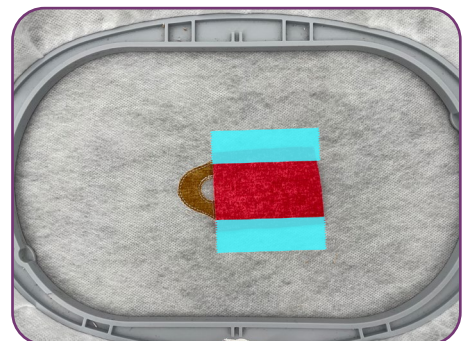

EMBROIDERY



□ Step 9

- Return the hoop to the machine.
- Stitch Machine Step 3, Cut Line and Tackdown.



□ Step 10

- Remove the hoop from the machine, but NOT the project from the hoop.
- Trim the excess fabric as close to the cut line as possible.



□ Step 11

- Return the hoop to the machine.
- Stitch the remaining machine steps per the thread chart, with matching bobbin thread.



EMBROIDERY



□ Step 12

- When the design is complete, remove the project from the hoop and trim the stabilizer 1/4" - 1/2" outside the design.



□ Step 13

- Rinse each piece under warm running water until the design is only slightly tacky.

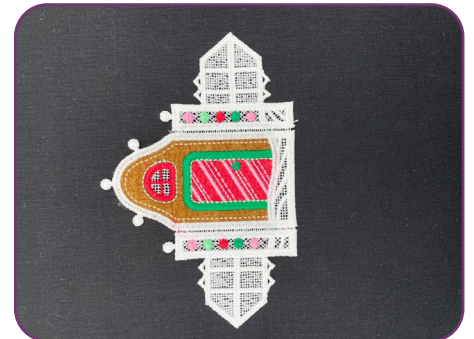

□ Step 14

- Lay right side down on a non-stick surface to dry. Parchment paper or a cooling rack work well to prevent curling. Let dry completely.
- Once dry, press right side down on a Perfect Embroidery Press Cloth.

ASSEMBLY



Step 15

- Before assembly, use a craft knife to cut through all the layers of the tab entries.
- Use the OESD Punch Tool with the 3mm attachment to create the eyelets indicated on the punch tool guide on page 24.
- **Tip:** Take care to not cut the satin stitching.

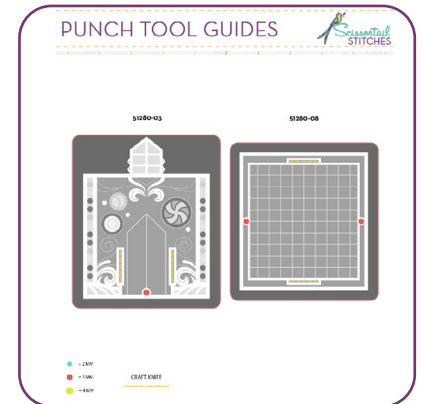

Step 16

- Line up the wall pieces 51280-01, 51280-02, 51280-03, 51280-04 to connect.
- Thread the sewing machine with matching thread in the top and bobbin.
- Stitch together using a multi-step zigzag stitch (also known as a serpentine stitch).
- Backstitch at the beginning and end to secure.
- Trim thread tails.
- Fold and press into shape.



Step 17

- Line up roof pieces 51280-10 and 51280-11 to connect.
- Stitch together using a multi-step zigzag.
- Backstitch at the beginning and end to secure.
- Trim thread tails.
- Set aside.



ASSEMBLY



Step 18

- Match the eyelets and buttonettes on walls (51280-01 to 51280-04).
- Use Alligator Clamps to pull each buttonette through the corresponding eyelet, using button clips to temporarily hold them in place, as needed.



Step 19

- Match the eyelets and lock tabs of the Attic Floor FSA (51280-08) to the base structure.
- Pull tabs and buttonettes through the corresponding openings.

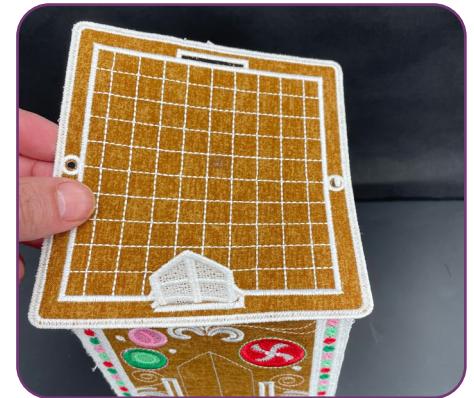

Step 20

- Match the eyelets of the Front Door Roof FSL (51280-06) to Front Door FSA (51280-05). Position the Front Door Roof FSL so the buttonettes are facing away from the locking tabs.

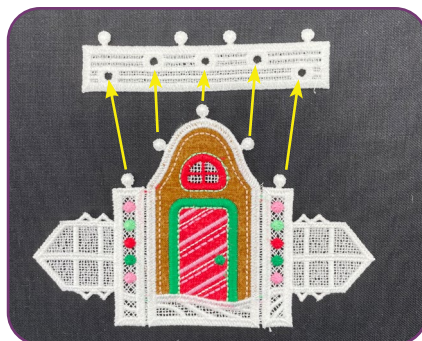

ASSEMBLY



Step 21

- Match the eyelets of the Front Door Snow FSL (51280-07) to the buttonettes of the Door Roof FSL (51280-06).



Step 22

- Match the locking tabs of the Front Door FSA (51280-05) into the tab entries of the Front Wall FSA (51280-03).
- Tip:** Pull the lock tabs from the bottom of the structure.



Step 23

- Match the house structure eyelets to the buttonettes on Foundation FSA (51280-09).
- Pull each buttonette through the corresponding eyelet, using button clips to temporarily hold them in place, as needed.

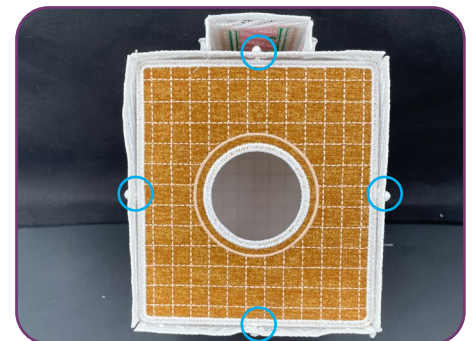

ASSEMBLY



Step 24

- Match the roof eyelets to the Front Gable FSA (51280-12) and Back Gable FSA (51280-13).

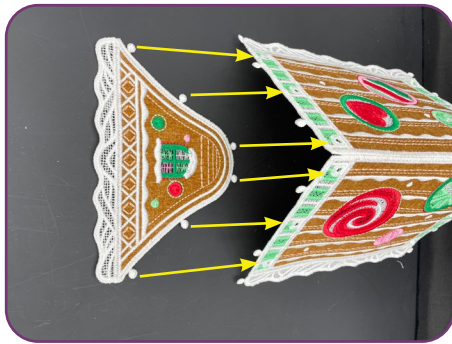

Step 25

- Match the roof snow eyelets to the buttonettes on both sides of the roof assembly (51280-14 & 51280-15).
- Pull each buttonette through the corresponding eyelet.

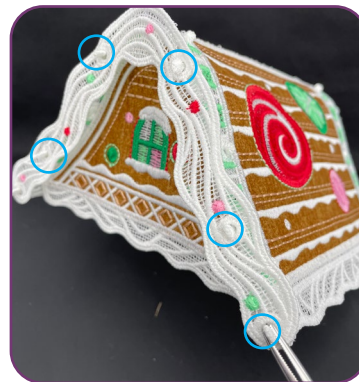
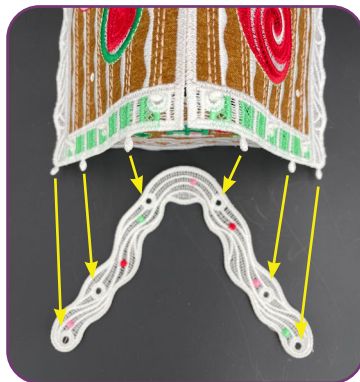

Step 26

- Place the roof on the house structure.
- Note: Roof is not connected to the structure.
- Tip: Place a tea light on the Attic Floor to illuminate the roof designs.



FINISHING TOUCHES



Step 27

- Add tealights or pixie lights to create a glow.



GENERAL FREESTANDING LACE GUIDE



Stabilizer

- OESD AquaMesh
- OESD BadgeMaster

Notion/Tools

- 80/12 Embroidery Ballpoint Titanium needle for extended needle life
- OESD Alligator Clamps
- OESD Button Clips
- OESD Perfect Point and Press Tool

Isacord Thread Colors

- All OESD designs are digitized with Isacord 40 wt. polyester thread as the top thread and in the bobbin.
- Refer to the thread chart for color specifications.
- Match bobbin thread color to the top thread.

Instructions

Step 1 - Hoop

For FSL structures, hoop one layer of OESD AquaMesh and one layer of OESD BadgeMaster. BadgeMaster contains more starch so, combined with the AquaMesh, the lace is more rigid.

For other FSL, where a softer lace is desired, hoop two layers of AquaMesh.

Step 2 - Embroider

Stitch the design per the thread chart with matching thread in the bobbin at each color change.

When complete, remove from the hoop and trim away excess stabilizer about 1/4"-1/2" from the stitching.

Step 3 - Rinse

Rinse remaining stabilizer out in warm running water.

For stiffer lace and FSL structures, DO NOT rinse away all of the stabilizer. The lace should be just slightly tacky.

For softer lace, rinse until all traces of the stabilizer is removed.

Step 4 - Dry

Lay right side down flat on a non-stick surface, such as a cookie rack, parchment paper or Teflon sheet. This minimizes the tendency for the lace to curl.

Let the pieces dry completely before proceeding with any assembly.

Step 5 - Press

Once completely dry, press right side down on a OESD Perfect Embroidery Press Cloth.

Step 6 - Assemble Structure

Note: Specific assembly instructions for a design/collection may be found in the thread chart pdf following the individual design color charts.

Lace must be COMPLETELY DRY before assembly. Wetting the buttonettes or eyelets to assemble is not recommended and may result in them stretching and coming "unbuttoned" when dry.

Use a pair of OESD Alligator Clamps to insert the buttonettes into the eyelets. Insert the tip of the OESD Alligator Clamps into the eyelet, grasp the buttonette and pull through the eyelet. Alternatively, use a stiletto or tweezers to push the buttonette through the eyelet.

Helpful Tips

Limp Lace

If the design is not stiff enough, press the lace pieces on the wrong side while applying spray starch. After ironing, spray again with starch and allow to dry completely. This will stiffen the lace pieces nicely and aid in construction. Or easily re-stiffen by diluting some stabilizer scraps in water (or use liquid starch) and dipping the item in the solution. Lay flat to dry.

Eyelets Too Small

If any of the eyelets appear closed or too small to penetrate with Alligator Clamps, they may be stretched by inserting the small end of the OESD Perfect Point and Press Tool into the eyelet opening and stretching it open wide enough to accommodate the OESD Alligator Clamps.

Button Clips

During the assembly process, some structures pull on buttonettes that have already been inserted and could pull them out altogether. Putting a Button Clip on the assembled buttonette will keep it in position during the assembly process. Remove the Button Clips when the assembly is complete.

Alternative Construction Option

In some cases, the buttonettes may be pulled to the inside of a project, instead of being visible on the outside.

Insert the OESD Alligator Clamps through the eyelet from the wrong, or inside, of the lace and grasp the corresponding buttonette. Pull the buttonette to the wrong side of the lace.

Pulling the buttonettes to the inside may cause stress on the ones already done. Button clips may be placed on the completed buttonette(s) to prevent them from pulling out of the eyelet.

PUNCH TOOL GUIDES



51280-03

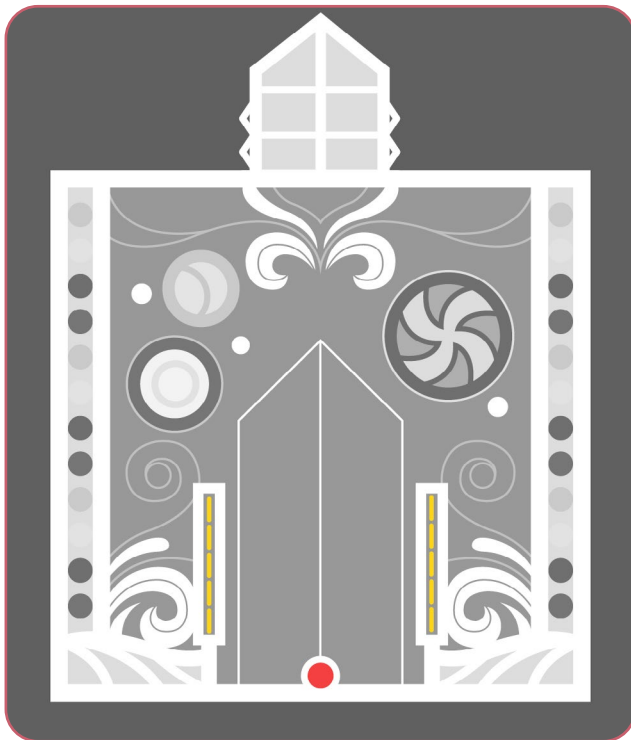

51280-08

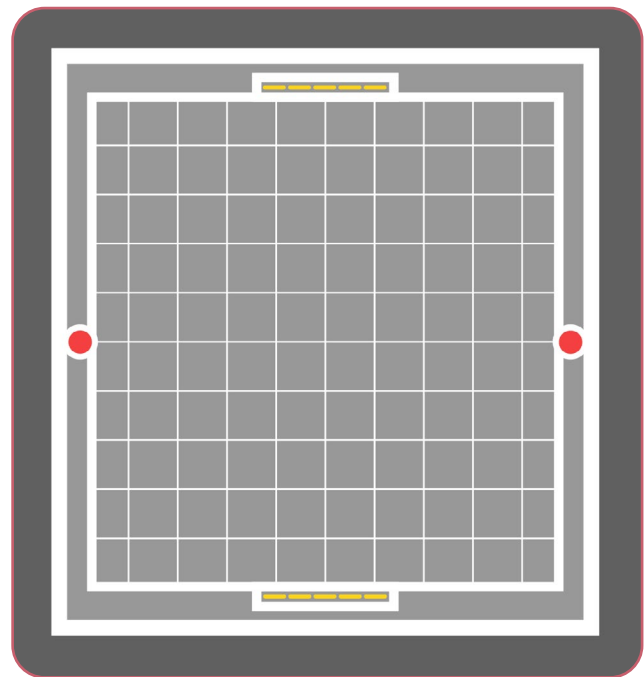

● = 2 MM

● = 3 MM

● = 4 MM

CRAFT KNIFE



PRINTING INSTRUCTIONS



ATTENTION

When printing this document, any page scaling or page fitting options in your print dialog box must be turned OFF or set to NONE so that your files will print out at their actual size. Images not printed at actual size will not function as intended.

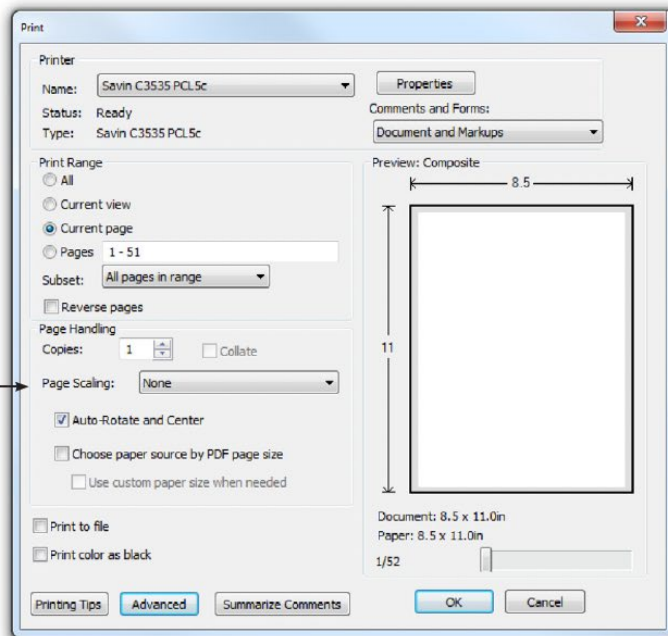

TO SAVE PAPER

Only print the desired image by navigating to the image's page, go to File > Print and select "Current page" in the print dialog box. Repeat for each desired image.

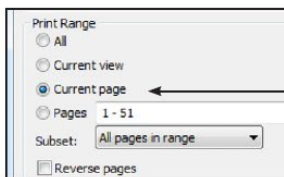

APPLIQUE PATTERNS



Print at 100%. No scaling. This box measures 1" x 1". Use the box as an accuracy guide when printing templates.

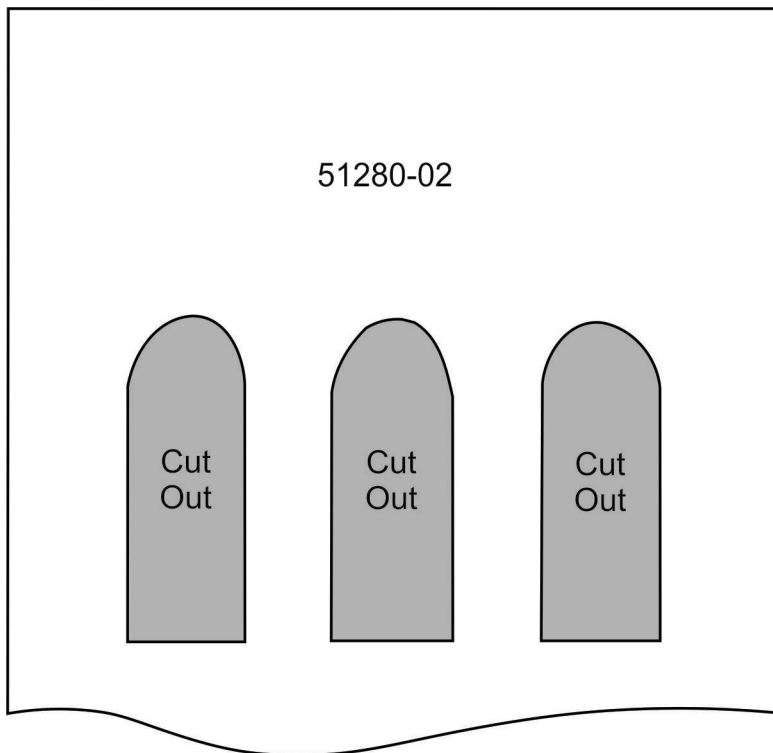
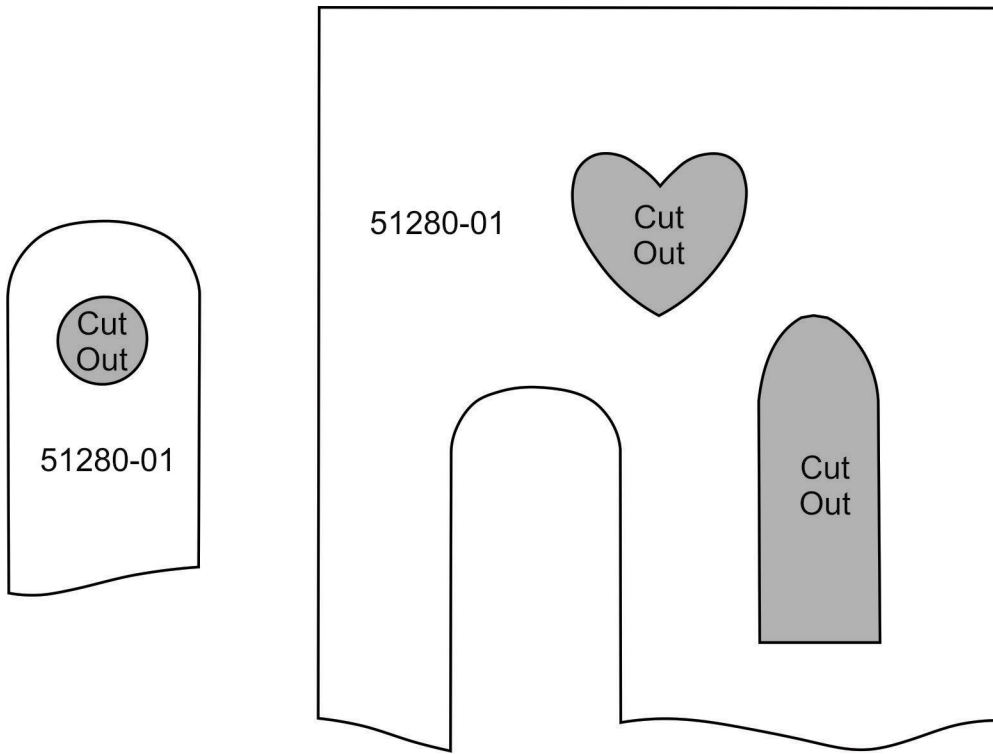

APPLIQUE PATTERNS



Print at 100%. No scaling. This box measures 1" x 1". Use the box as an accuracy guide when printing templates.

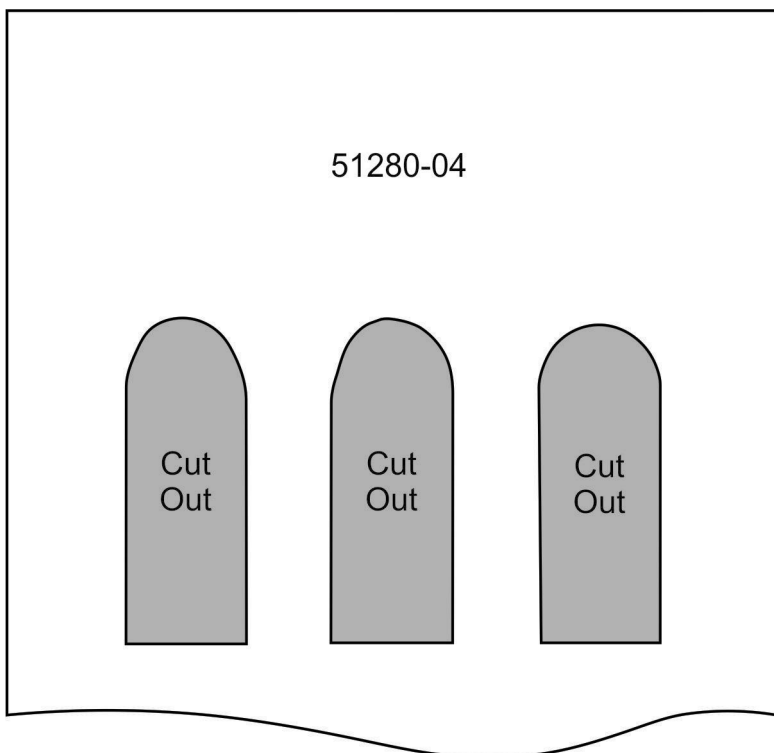
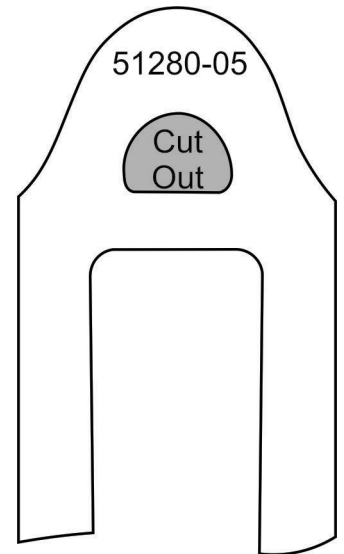
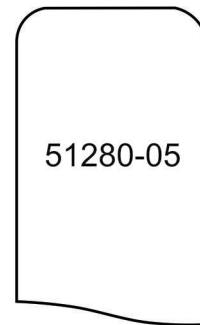
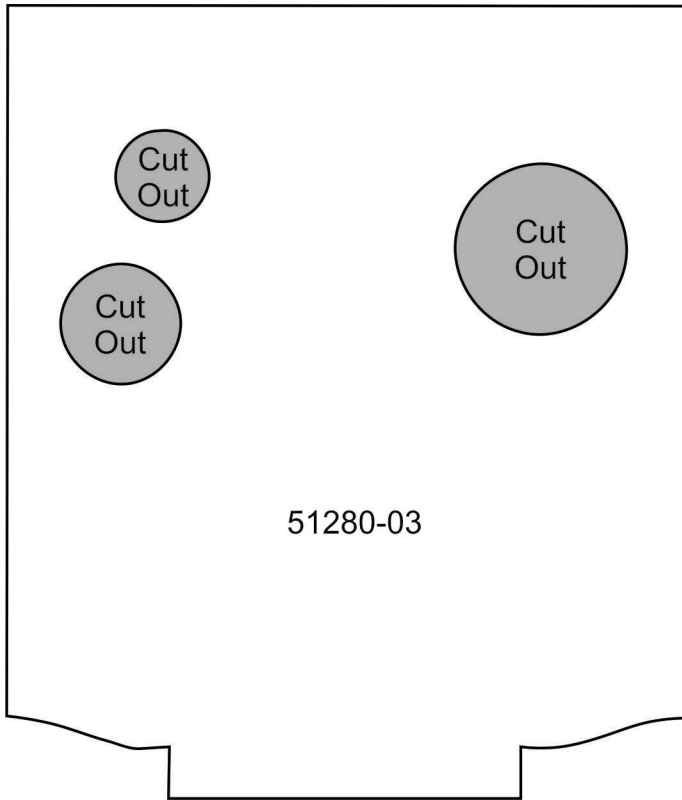

APPLIQUE PATTERNS



Print at 100%. No scaling. This box measures 1" x 1". Use the box as an accuracy guide when printing templates.

51280-08

APPLIQUE PATTERNS



Print at 100%. No scaling. This box measures 1" x 1". Use the box as an accuracy guide when printing templates.

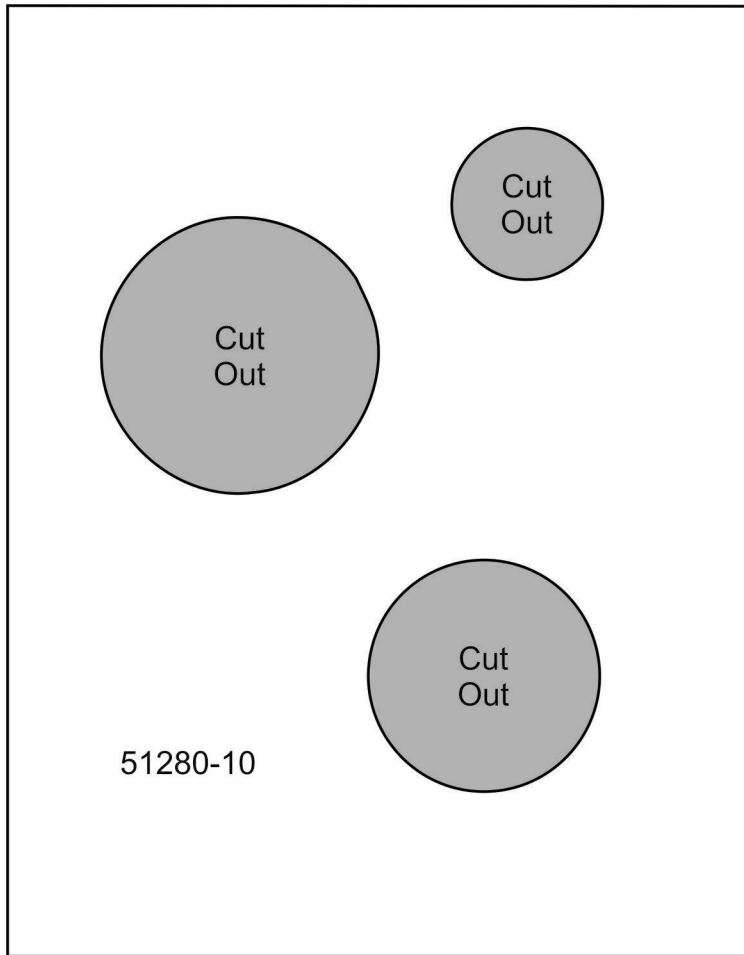

APPLIQUE PATTERNS



51280-09

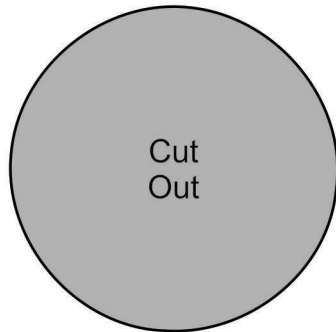

Print at 100%. No scaling. This box measures 1" x 1". Use the box as an accuracy guide when printing templates.

APPLIQUE PATTERNS



Print at 100%. No scaling. This box measures 1" x 1". Use the box as an accuracy guide when printing templates.

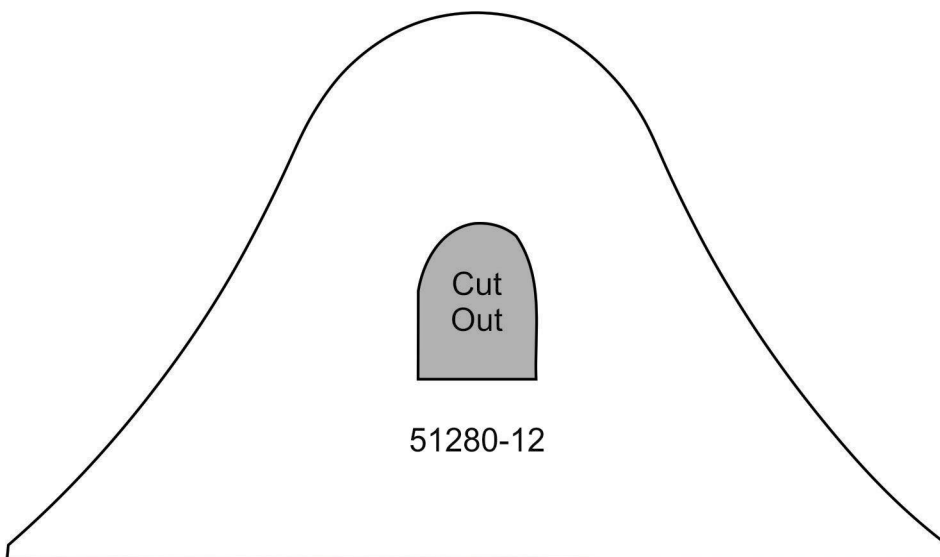
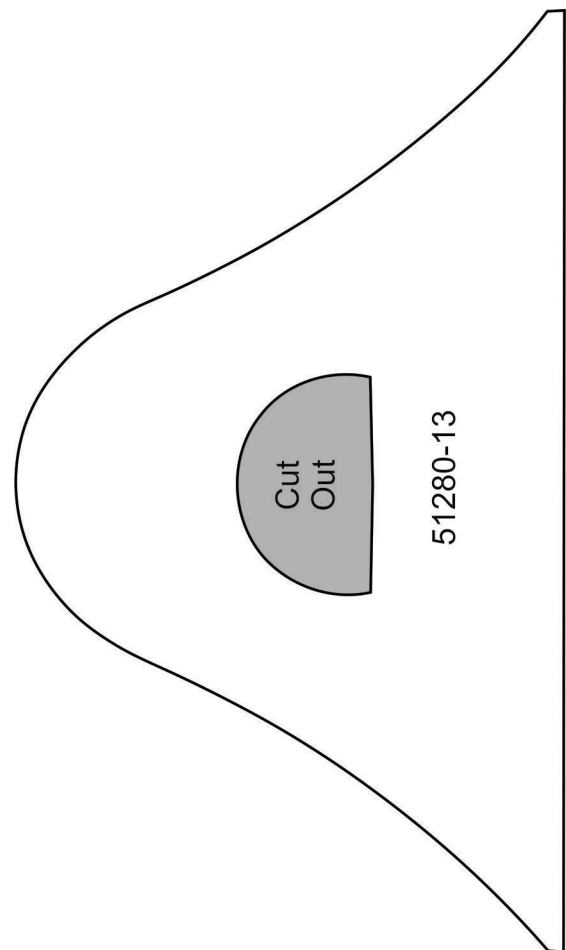
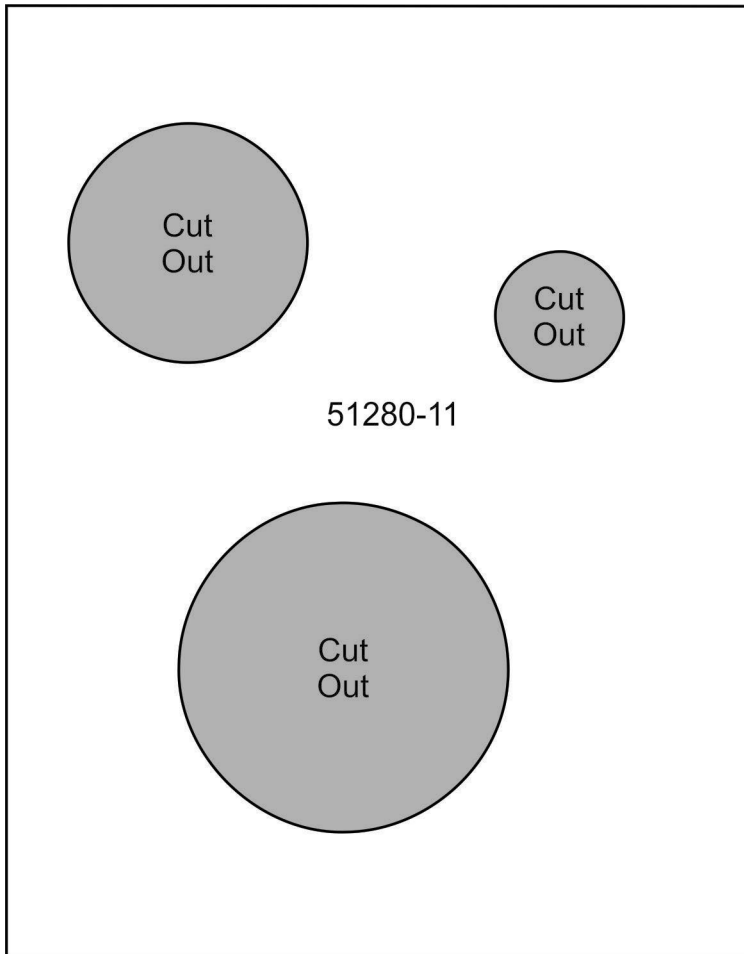

MIRRORED PATTERNS



Print at 100%. No scaling. This box measures 1" x 1". Use the box as an accuracy guide when printing templates.

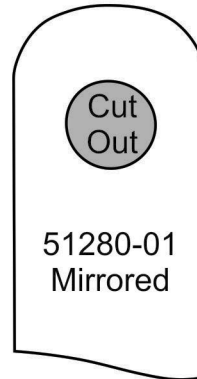
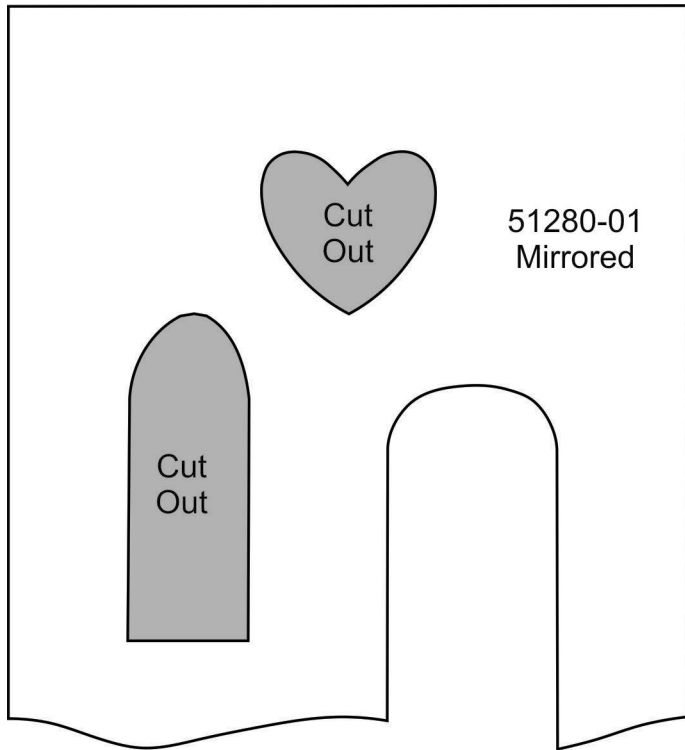

51280-02
Mirrored

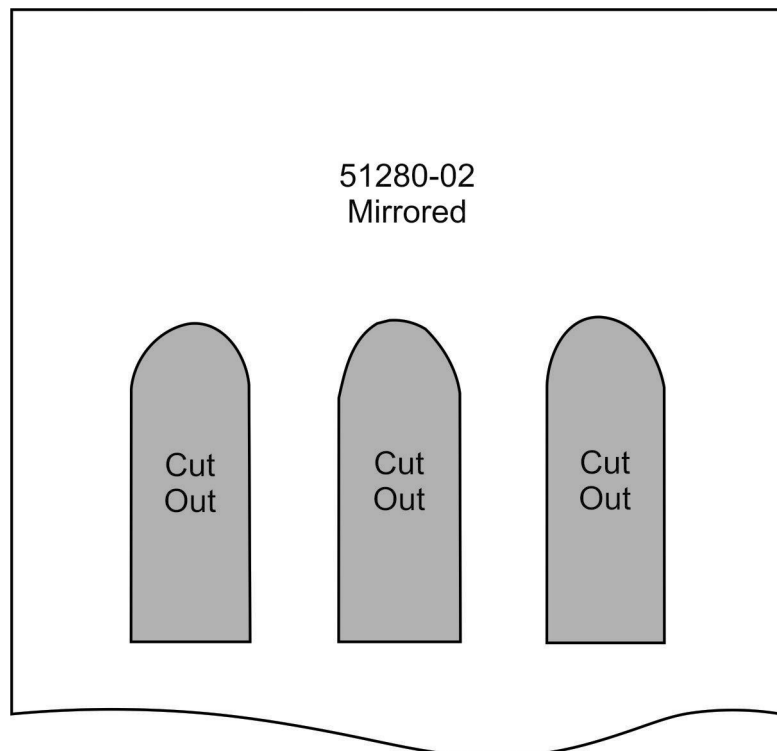

MIRRORED PATTERNS



Print at 100%. No scaling. This box measures 1" x 1". Use the box as an accuracy guide when printing templates.

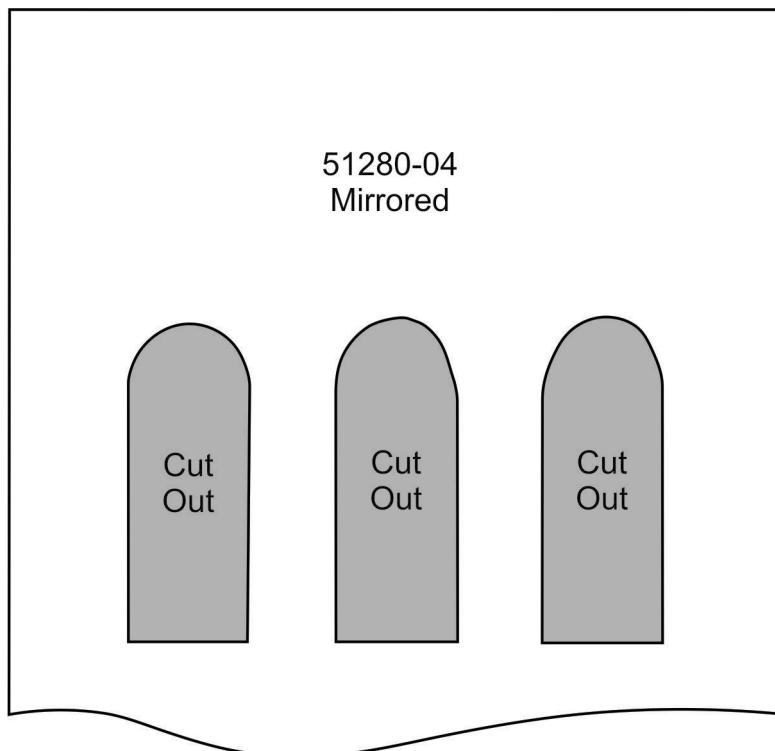
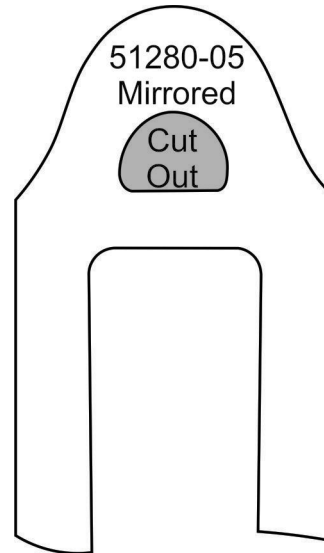
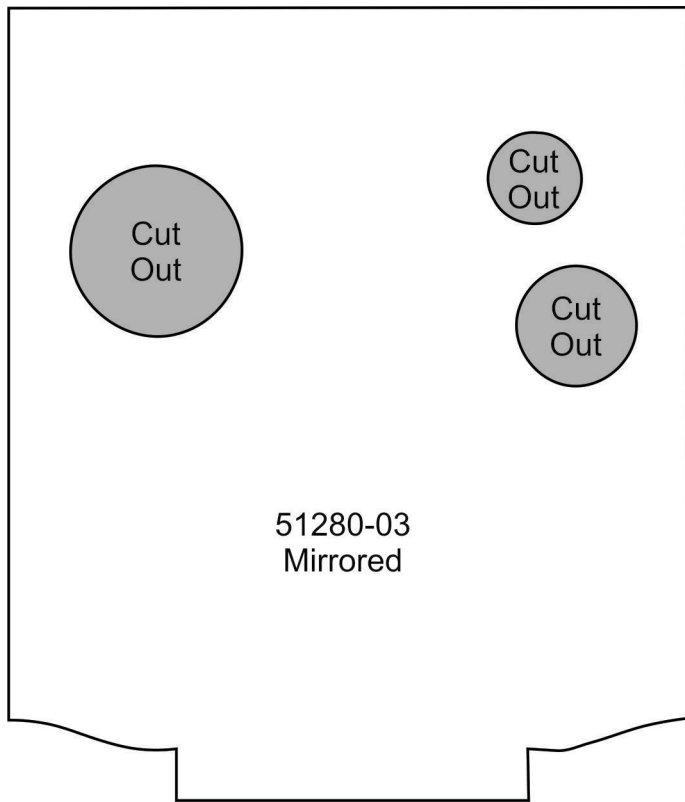

MIRRORED PATTERNS



Print at 100%. No scaling. This box measures 1" x 1". Use the box as an accuracy guide when printing templates.

51280-08
Mirrored

MIRRORED PATTERNS



51280-09
Mirrored

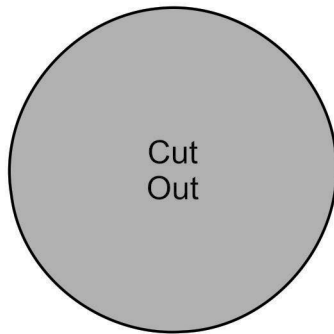

Print at 100%. No scaling. This box measures 1" x 1". Use the box as an accuracy guide when printing templates.

MIRRORED PATTERNS

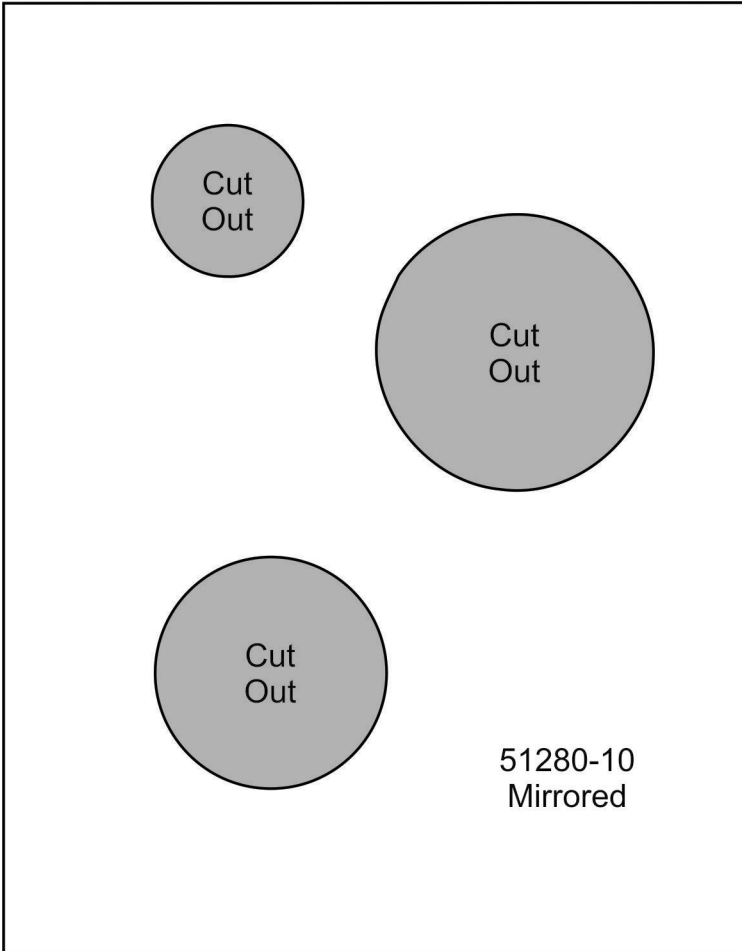

Print at 100%. No scaling. This box measures 1" x 1". Use the box as an accuracy guide when printing templates.

MIRRORED PATTERNS



Print at 100%. No scaling. This box measures 1" x 1". Use the box as an accuracy guide when printing templates.

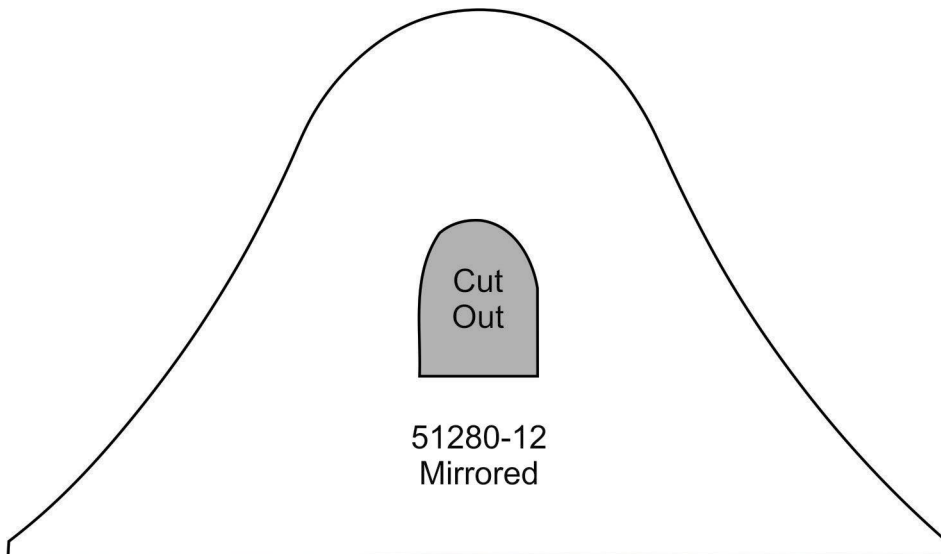
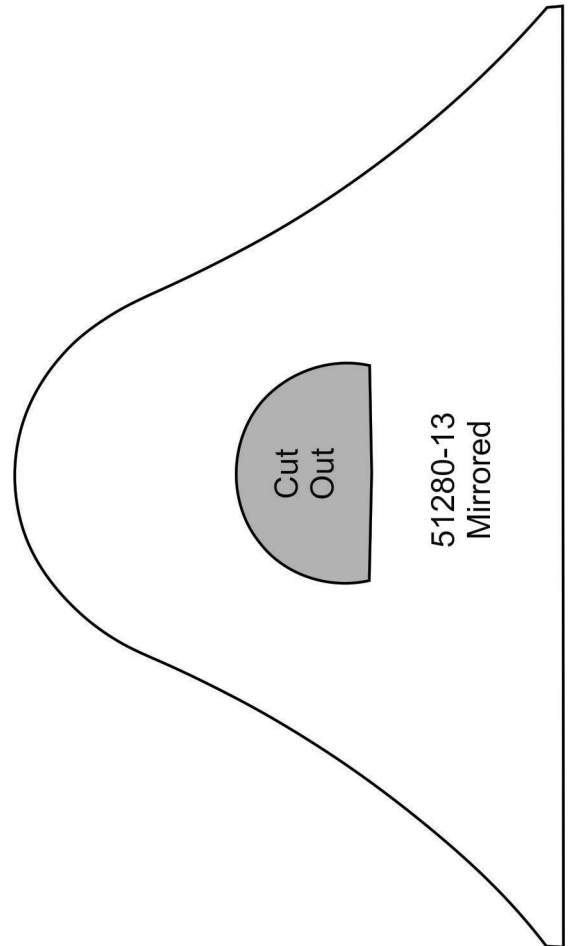
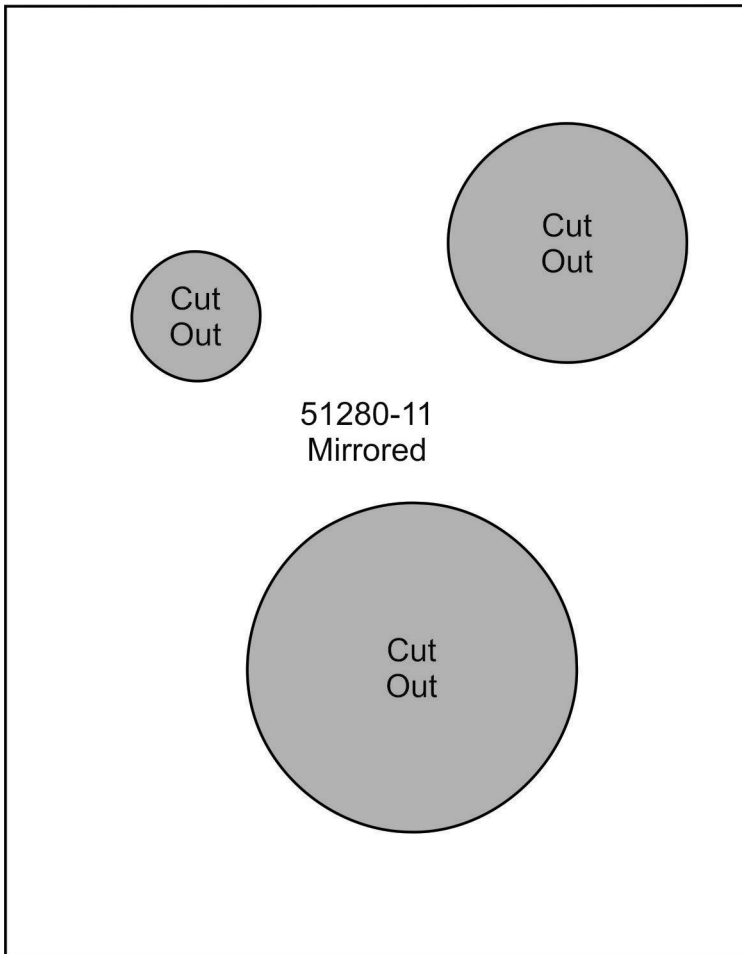



#51323
1 DESIGN/18 Files
PROJECT INSTRUCTIONS INCLUDED

FREESTANDING *Gingerbread Windmill*



It is a violation of Copyright law to make and distribute copies of electronic designs or artwork.
Electronic designs are licensed to the original purchaser for use at one location. ©2023 OESD, LLC. All rights reserved.

MATERIALS



Isacord Thread Colors

0015 White (2 Spools)
1141 Tan
1900 Geranium
2530 Rose
4430 Island Waters

Note: One spool of 1000 meter thread is adequate for the project unless otherwise noted.

MATERIALS



Stabilizers

- OESD AquaMesh WashAway
- OESD BadgeMaster WashAway
- OESD StabilStick CutAway
- OESD Applique Fuse and Fix
- OESD Fiber Form

Fabrics/Textiles

- Brown quilter's cotton 1/4 yard
- Red OESD Luxe Sparkle Vinyl
- White OESD Luxe Sparkle Vinyl
- Note: Fabric sizes are estimates and may result in overage.

Notion & Tools

- OESD Alligator Clamps
- OESD Button Clips
- OESD Expert Embroidery Tape TearAway
- OESD Expert Embroidery Tape WashAway
- OESD Perfect Punch Tool
- OESD Perfect Embroidery Press Cloth
- OESD Grippy GRID
- 1/4" Dowel cut to 5" long
- Embroidery Needle Sharp 75/11 (FSA)
- Embroidery Needle Ballpoint 80/12 (FSL)

Isacord Thread Colors

- Per thread chart
- Match the bobbin thread to the upper thread.

SUMMARY



Finished project size: Size 9" H x 5 1/2" W x 5 1/2" D

Bottom Side Wall 1
FSA
51323-01



Bottom Front Wall
FSA
51323-02



Bottom Side Wall 2
FSA
51323-03



Bottom Back Wall FSA
51323-04



Front Door Walls
FSA
51323-05



Requires 1 Design
Front Door Roof
FSA
51323-06

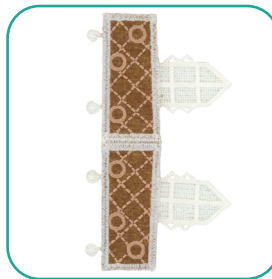

Requires 1 Design
Front Door Snow
FSL
51323-07



Requires 1 Design
Top Side Wall 1
FSA
51323-08



Requires 1 Design
Top Front Wall
FSA
51323-09



Requires 1 Design
Top Side Wall 2
FSA
51323-10



Requires 1 Design
Top Back Wall
FSA
51323-11



Requires 1 Design
Roof FSA
51323-12



Requires 1 Design
Roof Snow FSL
51323-13

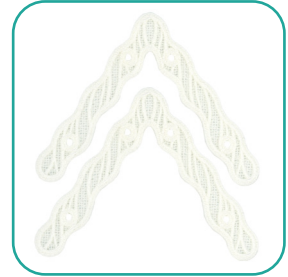

Requires 1 Design
Platform FSA
51323-14

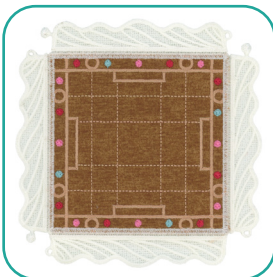

Requires 1 Design
Back Blades Holder FSL
51323-15



Requires 1 Design
Blades FSA
51323-16



Requires 1 Design
Front Blades Holder FSA
51323-17



Requires 1 Design
Foundation FSA
51323-18

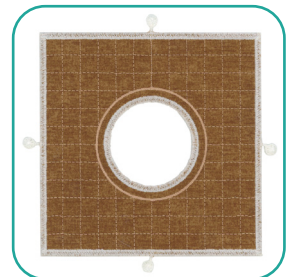

Requires 1 Design

Requires 1 Design

Requires 1 Design

Requires 1 Design

Requires 1 Design

It is a violation of Copyright law to make and distribute copies of electronic designs or artwork.

Electronic designs are licensed to the original purchaser for use at one location. ©2023 OESD, LLC. All rights reserved.

EMBROIDERY

General Instructions

The freestanding applique instructions, included in the collection, are general instructions. For demonstration purposes, a sample design that best demonstrates the technique is shown. Fabric and thread requirements will vary by design, but the general technique is the same. All designs are stitched with matching thread, top and bobbin.

Note: Some thread colors in instructions have been changed or digitally enhanced for better visibility.

Step 1

- Print the mirrored version of the templates (at 100% scale or 1:1 ratio) onto the paper side of Applique Fuse and Fix.
- Cut approximately 1/4"-1/2" outside the printed applique templates.

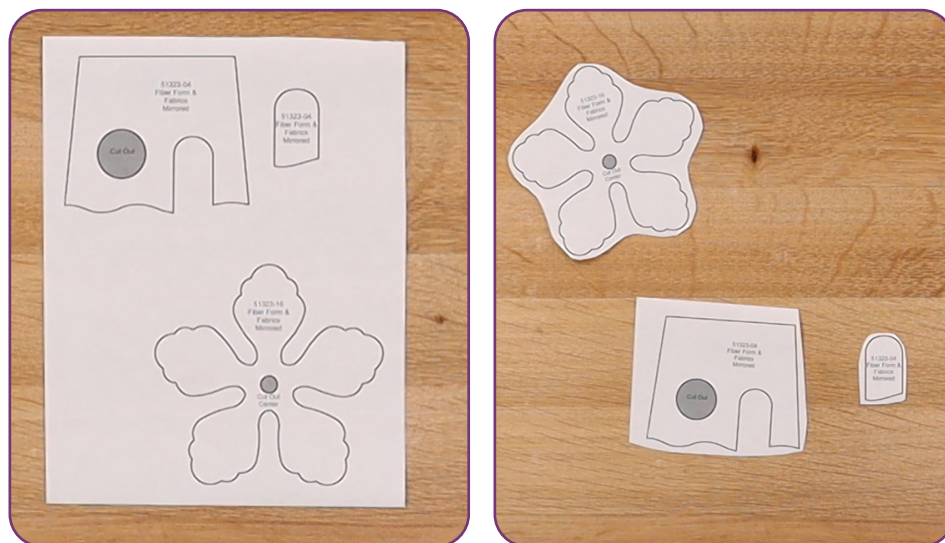

EMBROIDERY

Step 2

- Cut the Fiber Form 1/4"-1/2" larger than the applique templates.
- Fuse the trimmed templates to the back of the Fiber Form with the paper side of the printed template up. Hold the iron on the template for 10-15 seconds for a secure fuse.

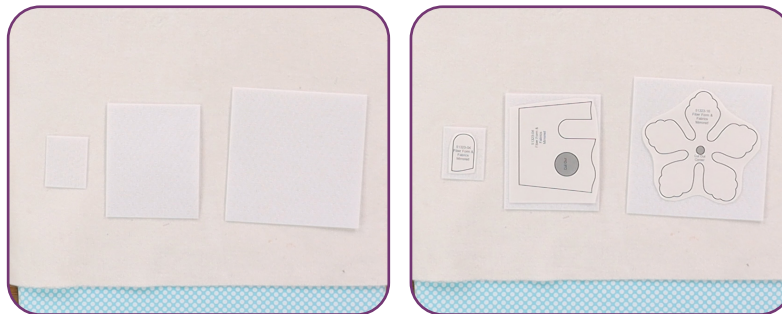

Step 3

- Trim the Fiber Form on the edge of the black outline.
- Set aside.



Step 4

- Adhere one layer of StabilStick CutAway to the wrong side of all applique fabrics, including the Luxe Sparkle Vinyl, to provide stiffness to the finished structure.
- Cut the prepared applique fabrics 1/4"-1/2" larger than the templates that are included at the end of the instructions.

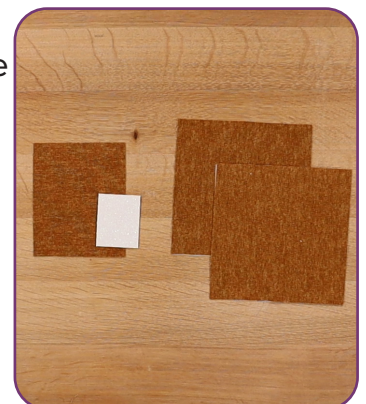

EMBROIDERY

□ Step 5

- Hoop one layer of AquaMesh and one layer of BadgeMaster for all designs.

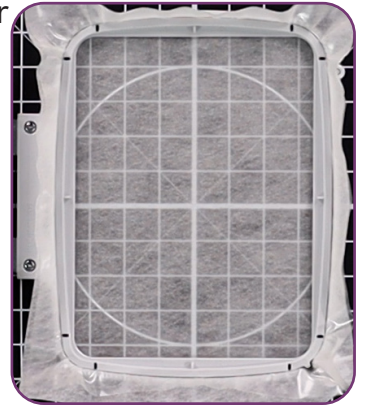

□ Step 6

- Load selected design into the machine.
- Example design is 51323-04.
- Thread the machine per the thread chart.
- Place hoop on the machine.
- Stitch Machine Step 1, Fiber Form and Brown Fabric Placement Stitch.

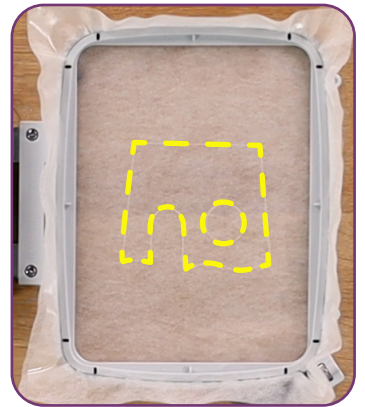

□ Step 7

- Remove the hoop from the machine, but NOT the project from the hoop.
- Lay the hoop on a flat surface.
- On the back of the Fiber Form, score and remove the paper backing to reveal the adhesive surface.
- Place the Fiber Form within the placement stitching.
- Finger press to secure.

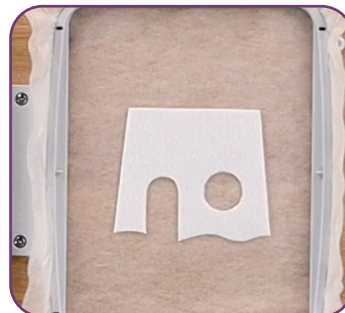

EMBROIDERY

□ Step 8

- Completely cover the Fiber Form and the placement stitch with the prepared applique fabric.
- Tape in place to secure.

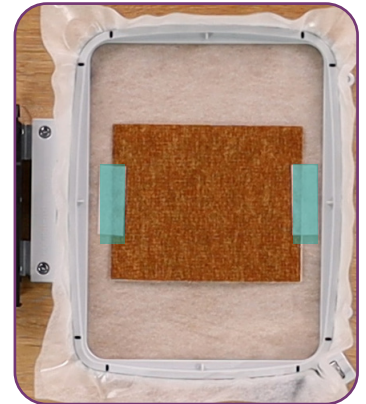

□ Step 9

- Return the hoop to the machine.
- Stitch Machine Step 2, Cut Line and Tackdown.

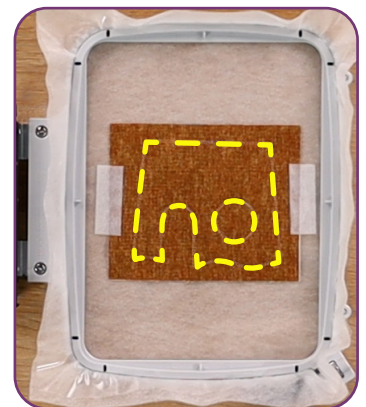

□ Step 10

- Remove the hoop from the machine, but NOT the project from the hoop.
- Trim the excess fabric as close to the cut line as possible. If the outermost stitches (cut line) are cut, the inner stitches (tackdown) will hold the applique in place.
Tip: If the stabilizer is cut or a hole is created while trimming the fabric, use OESD Expert Embroidery Tape WashAway as a patch.



EMBROIDERY

□ Step 11

- Return the hoop to the machine.
- Stitch Machine Step 3, White Vinyl Placement Stitch.

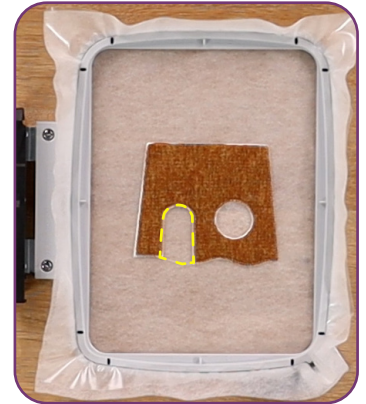

□ Step 12

- Remove the hoop from the machine, but NOT the project from the hoop.
- Lay the hoop on a flat surface.
- On the back of the Fiber Form, score and remove the paper backing to reveal the adhesive surface.
- Place the Fiber Form within the placement stitching.
- Finger press to secure.

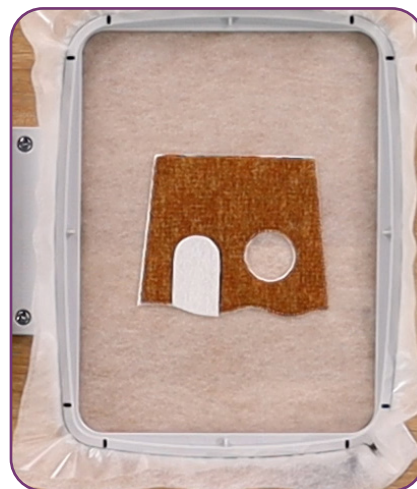

EMBROIDERY

□ Step 13

- Completely cover the Fiber Form and the placement stitch with the prepared Luxe Sparkle Vinyl.
- Tape in place to secure.



□ Step 14

- Return the hoop to the machine.
- Stitch Machine Step 4, Cut Line and Tackdown.

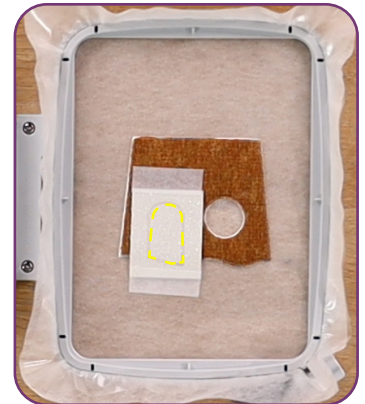

□ Step 15

- Remove the hoop from the machine, but NOT the project from the hoop.
- Trim the excess vinyl as close to the cut line as possible.



EMBROIDERY

□ Step 16

- Return the hoop to the machine.
- Stitch the remaining machine steps per the thread with matching bobbin thread.



□ Step 17

- When the design is complete, remove the project from the hoop and trim the stabilizer 1/4" - 1/2" outside the design.



EMBROIDERY - DOUBLE SIDED APPLIQUE



Design: 51323-16

□ Step 18

- Hoop one layer of AquaMesh and one layer of BadgeMaster for all designs.

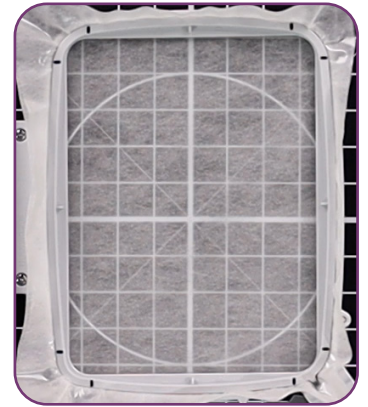

□ Step 19

- Load selected design into the machine.
- Example design is 51323-16.
- Thread the machine per the thread chart.
- Match the bobbin thread to the upper thread throughout.
- Stitch Machine Step 1, Fiber Form/Front Brown Fabric Placement Stitch.

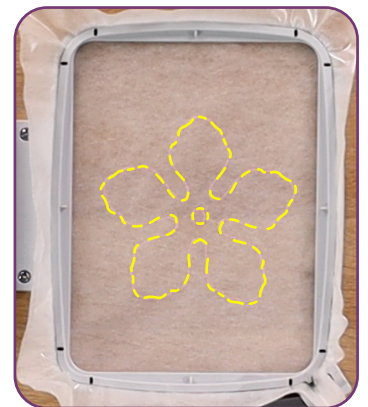

EMBROIDERY - DOUBLE SIDED APPLIQUE



□ Step 20

- Remove the hoop from the machine, but NOT the project from the hoop.
- Place the hoop on a flat surface.
- On the back of the Fiber Form, score and remove the paper backing to reveal the adhesive surface.
- Place the Fiber Form within the placement stitching.
- Finger press to secure.



□ Step 21

- Completely cover the Fiber Form and the placement stitch with the prepared applique fabric.
- Tape in place to secure.

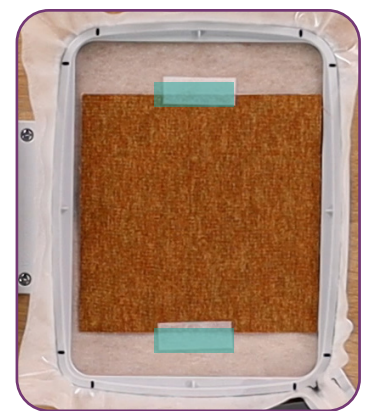

EMBROIDERY - DOUBLE SIDED APPLIQUE



□ Step 22

- Return the hoop to the machine.
- Stitch Machine Step 2, Cut Line and Tackdown.



□ Step 23

- Remove the hoop from the machine, but NOT the project from the hoop.
- Trim the excess fabric as close to the cut line as possible. If the outermost stitches (cut line) are cut, the inner stitches (tackdown) will hold the applique in place.
Tip: If the stabilizer is cut or a hole is created while trimming the fabric, use OESD Expert Embroidery Tape WashAway as a patch.



□ Step 24

- Return the hoop to the machine and stitch machine steps 3-5, per the thread chart.



EMBROIDERY - DOUBLE SIDED APPLIQUE

Step 25

- Remove the hoop from the machine, but NOT the project from the hoop.
- Turn the hoop over and place the prepared applique fabric, right side up, completely covering the design.
- Carefully tape to secure.

Tip: Avoid pushing too hard on the stabilizer to prevent it from dislodging from the hoop.

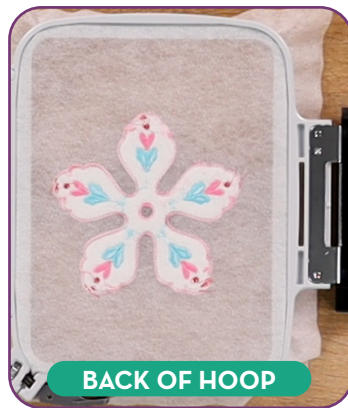

Step 26

- Return the hoop to the machine.
- Stitch Machine Step 6, Cut Line and Tackdown.



EMBROIDERY - DOUBLE SIDED APPLIQUE

□ Step 27

- Remove the hoop from the machine, but NOT the project from the hoop.
- Turn the hoop over and trim the excess fabric as close to the cut line as possible.



□ Step 28

- Return the hoop to the machine.
- Stitch the remaining machine steps per the thread with matching bobbin thread.



□ Step 29

- When the design is complete, remove the project from the hoop and trim the stabilizer 1/4" - 1/2" outside the design.



GENERAL FREESTANDING LACE GUIDE



Design:

51323-07, 51323-13, 51323-15

Stabilizer

- OESD AquaMesh
- OESD BadgeMaster

Notion/Tools

- 80/12 Embroidery Ballpoint Titanium needle for extended needle life
- OESD Alligator Clamps
- OESD Button Clips
- OESD Perfect Point and Press Tool

Isacord Thread Colors

- All OESD designs are digitized with Isacord 40 wt. polyester thread as the top thread and in the bobbin.
- Refer to the thread chart for color specifications.
- Match bobbin thread color to the top thread.

Instructions

Step 1 - Hoop

For FSL structures, hoop one layer of OESD AquaMesh and one layer of OESD BadgeMaster. BadgeMaster contains more starch so, combined with the AquaMesh, the lace is more rigid.

For other FSL, where a softer lace is desired, hoop two layers of AquaMesh.

Step 2 - Embroider

Stitch the design per the thread chart with matching thread in the bobbin at each color change.

When complete, remove from the hoop and trim away excess stabilizer about 1/4"-1/2" from the stitching.

Step 3 - Rinse

Rinse remaining stabilizer out in warm running water.

For stiffer lace and FSL structures, DO NOT rinse away all of the stabilizer. The lace should be just slightly tacky.

For softer lace, rinse until all traces of the stabilizer is removed.

Step 4 - Dry

Lay right side down flat on a non-stick surface, such as a cookie rack, parchment paper or Teflon sheet. This minimizes the tendency for the lace to curl.

Let the pieces dry completely before proceeding with any assembly.

Step 5 - Press

Once completely dry, press right side down on a OESD Perfect Embroidery Press Cloth.

Step 6 - Assemble Structure

Note: Specific assembly instructions for a design/collection may be found in the thread chart pdf following the individual design color charts.

Lace must be COMPLETELY DRY before assembly. Wetting the buttonettes or eyelets to assemble is not recommended and may result in them stretching and coming "unbuttoned" when dry.

Use a pair of OESD Alligator Clamps to insert the buttonettes into the eyelets. Insert the tip of the OESD Alligator Clamps into the eyelet, grasp the buttonette and pull through the eyelet. Alternatively, use a stiletto or tweezers to push the buttonette through the eyelet.

Helpful Tips

Limp Lace

If the design is not stiff enough, press the lace pieces on the wrong side while applying spray starch. After ironing, spray again with starch and allow to dry completely. This will stiffen the lace pieces nicely and aid in construction. Or easily re-stiffen by diluting some stabilizer scraps in water (or use liquid starch) and dipping the item in the solution. Lay flat to dry.

Eyelets Too Small

If any of the eyelets appear closed or too small to penetrate with Alligator Clamps, they may be stretched by inserting the small end of the OESD Perfect Point and Press Tool into the eyelet opening and stretching it open wide enough to accommodate the OESD Alligator Clamps.

Button Clips

During the assembly process, some structures pull on buttonettes that have already been inserted and could pull them out altogether. Putting a Button Clip on the assembled buttonette will keep it in position during the assembly process. Remove the Button Clips when the assembly is complete.

Alternative Construction Option

In some cases, the buttonettes may be pulled to the inside of a project, instead of being visible on the outside.

Insert the OESD Alligator Clamps through the eyelet from the wrong, or inside, of the lace and grasp the corresponding buttonette. Pull the buttonette to the wrong side of the lace.

Pulling the buttonettes to the inside may cause stress on the ones already done. Button clips may be placed on the completed buttonette(s) to prevent them from pulling out of the eyelet.

ASSEMBLY

□ Step 30

- Rinse each piece in warm running water until the design is only slightly tacky.
- Place right side down on a non-stick surface to dry. Parchment paper or a cooling rack work well to prevent curling. Dry completely.
- Once dry, press right side down on a Perfect Embroidery Press Cloth.



□ Step 31

- Before assembly, use a craft knife to cut through all the layers of the tab entries.
- Use the OESD Punch Tool with the 3mm attachment to create the eyelets indicated in the diagram.
Tip: Take care to not cut the satin stitching.
- Reference the Punch Tool Guide on page 27.

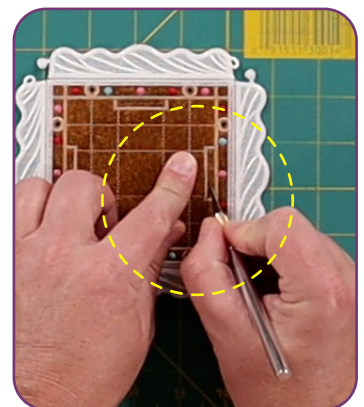

□ Step 32

- Line up the bottom wall pieces 51323-01, 51323-02, 51323-03, to connect.
- Thread the sewing machine with matching thread in the top and bobbin.
- Stitch together using a multi-step zigzag stitch (also known as a serpentine stitch).
- Back stitch at the beginning and end to secure.
- Trim thread tails.
- Fold and press into shape.

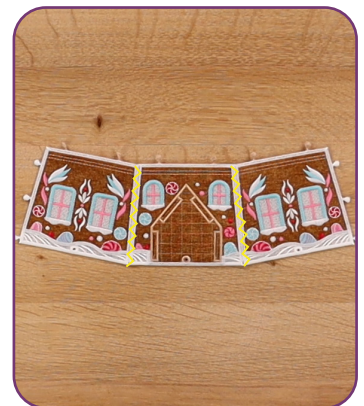

ASSEMBLY

□ Step 33

- Line up the top wall pieces 51323-08, 51323-09, 51323-10, to connect.
- Stitch together using a multi-step zigzag.
- Back stitch at the beginning and end to secure.
- Trim thread tails.
- Fold and press into shape.



□ Step 34

- Match the eyelets of the Front Door Roof FSA (51323-06) to Front Door Walls FSA (51323-05). Position the Front Door Roof FSA so the buttonettes are facing away from the locking tabs.
- Use Alligator Clamps to pull each buttonette through the corresponding eyelet, using button clips to temporarily hold them in place, as needed.



ASSEMBLY

□ Step 35

- Match the eyelets of the Front Door Snow FSL (51323-07) to the buttonettes of the Front Door Roof FSA (51323-06).
- Pull each buttonette through the corresponding eyelet.

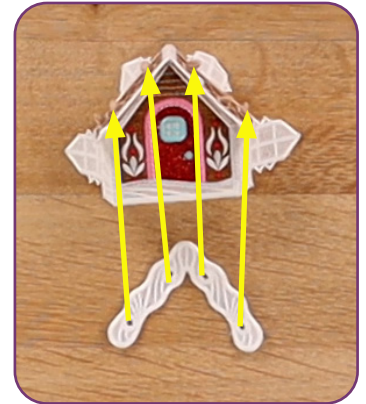

□ Step 36

- Insert the locking tabs of the Front Door Walls FSA (51323-05) and Front Door Roof FSA (51323-06) into the tab entries of the Bottom Front Wall FSA (51323-02).

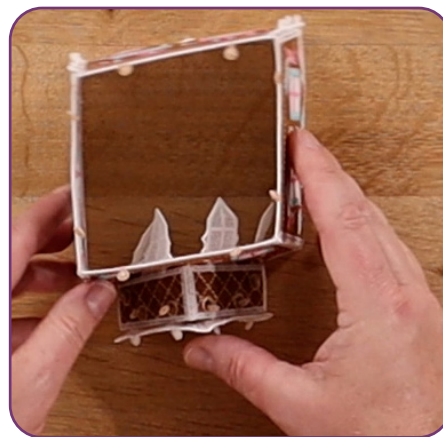
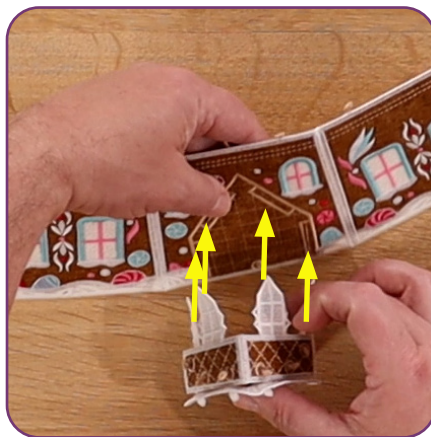

ASSEMBLY

Step 37

- Match the buttonettes of the bottom wall assembly to the eyelets of the Bottom Back Wall FSA (51323-04).
- Pull each buttonette through the corresponding eyelet.

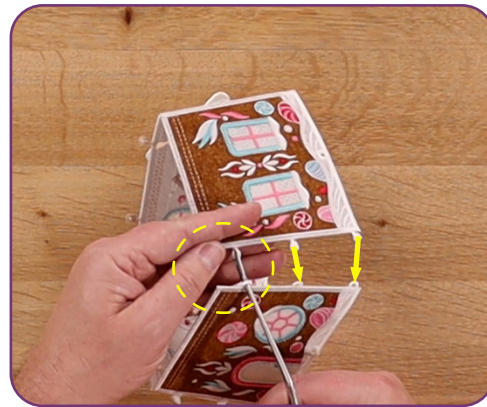

Step 38

- Match the buttonettes of the top wall assembly to the eyelets of the Top Back Wall FSA (51323-11).
- Pull each buttonette through the corresponding eyelet.

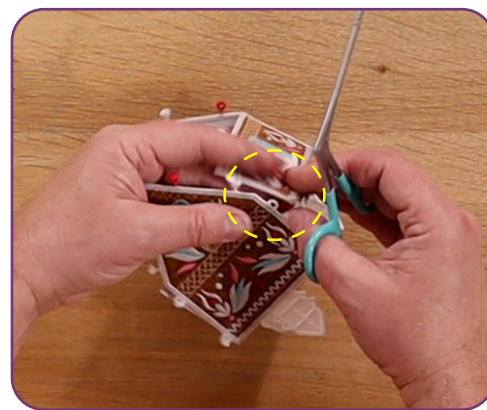

ASSEMBLY

Step 39

- Match the buttonettes of the top wall assembly to the eyelets of the Roof FSA (51323-12).
- Pull each buttonette through the corresponding eyelet.

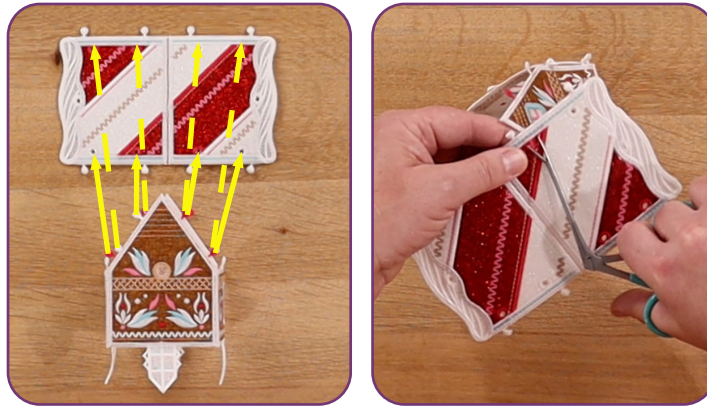

Step 40

- Match the Roof Snow FSL (51323-13) eyelets to the buttonettes on both sides of the Roof FSA (51323-12).
- Pull each buttonette through the corresponding eyelet.



ASSEMBLY

Step 41

- Match the buttonettes of the bottom wall assembly to the eyelets of the Platform FSA (51323-14).
- Pull each buttonette through the corresponding eyelet.

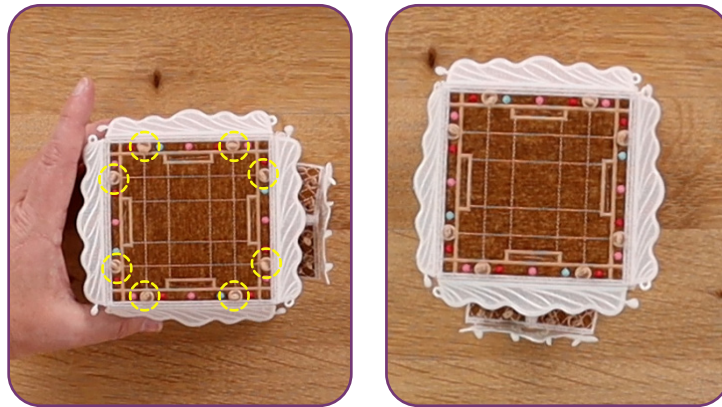

Step 42

- Bend at the folds and connect the buttonettes on the Platform FSA (51323-14) to their corresponding eyelets.

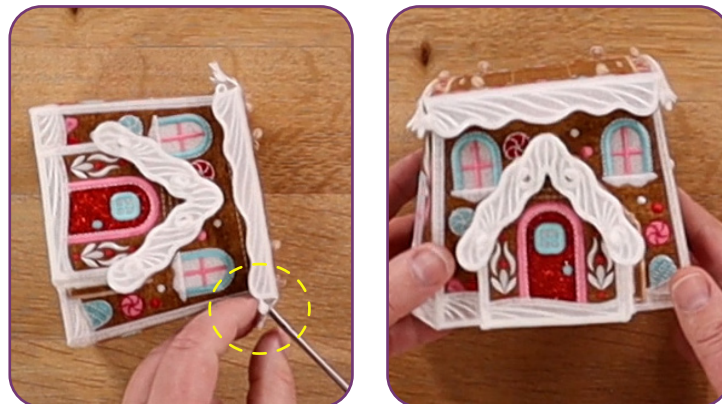

ASSEMBLY

Step 43

- Insert the dowel through the top wall assembly.



Step 44

- Insert the locking tabs of the top wall assembly into the tab entries of the Platform FSA (51323-14).

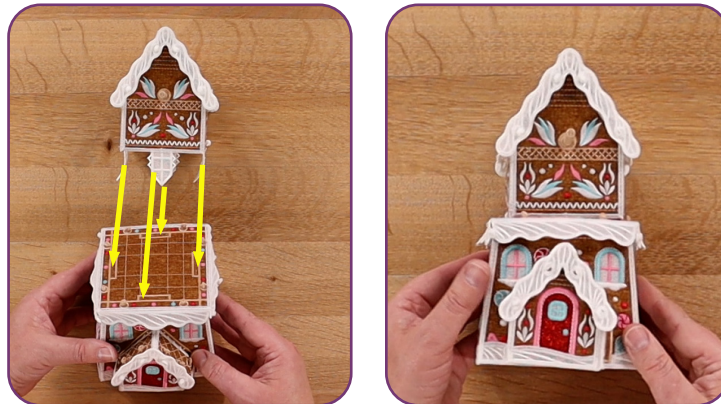

ASSEMBLY

□ Step 45

- Match the eyelets of the bottom wall assembly to the buttonettes of the Foundation FSA (51323-18).
- Pull each buttonette through the corresponding eyelet.

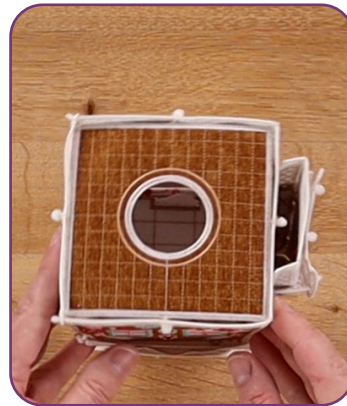
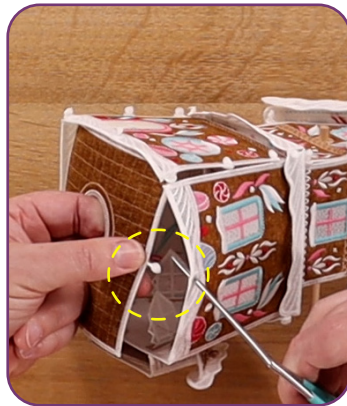

□ Step 46

- Slide the Back Blades Holder FSL (51323-15) onto the dowel.



ASSEMBLY

□ Step 47

- Slide the Blades FSA (51323-16) onto the dowel.



□ Step 48

- Slide the Front Blades Holder FSL (51323-17) onto the dowel.



□ Step 49- Finishing Touches

- Add tea lights or pixie lights to create a glow.
- The project is complete. Enjoy!



PUNCH TOOL GUIDES

51323-02

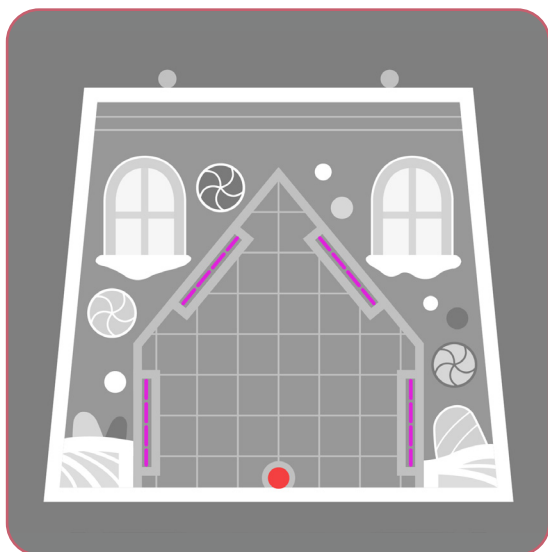

51323-06

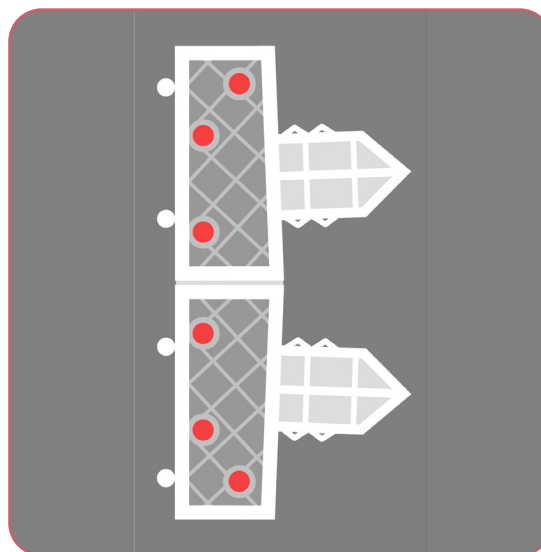

51323-13

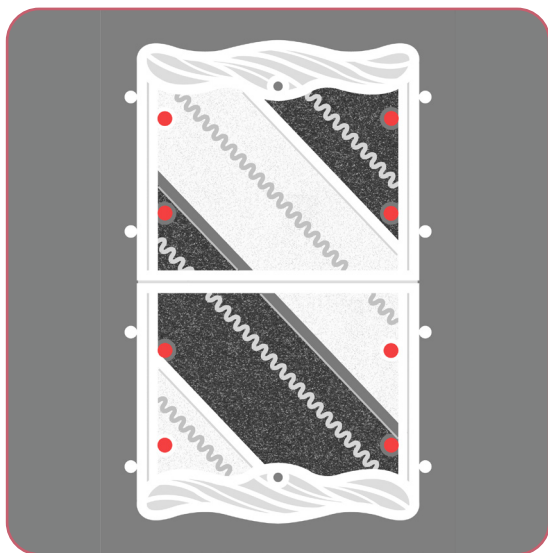

51323-15

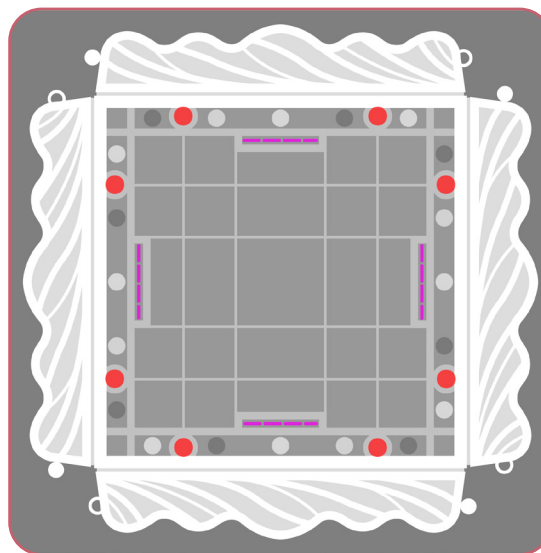

- = 2 MM
- = 3 MM
- = 4 MM

CRAFT KNIFE



PRINTING INSTRUCTIONS



ATTENTION

When printing this document, any page scaling or page fitting options in your print dialog box must be turned OFF or set to NONE so that your files will print out at their actual size. Images not printed at actual size will not function as intended.

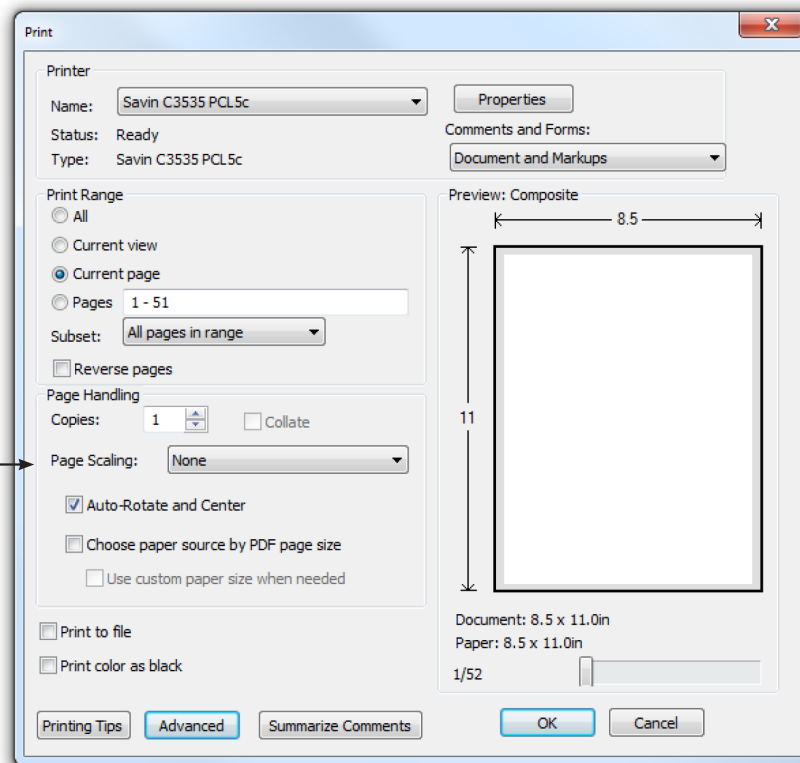

TO SAVE PAPER

Only print the desired image by navigating to the image's page, go to File > Print and select "Current page" in the print dialog box. Repeat for each desired image.

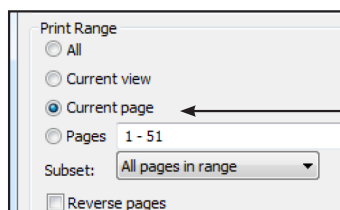

APPLIQUE PATTERNS



Print at 100%. No scaling. This box measures 1" x 1". Use the box as an accuracy guide when printing templates.

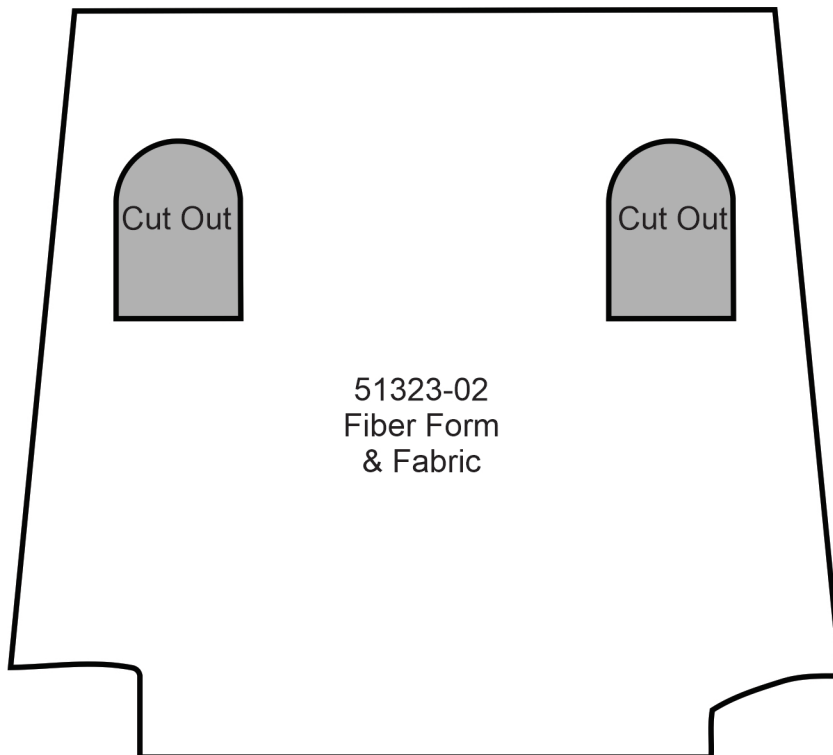
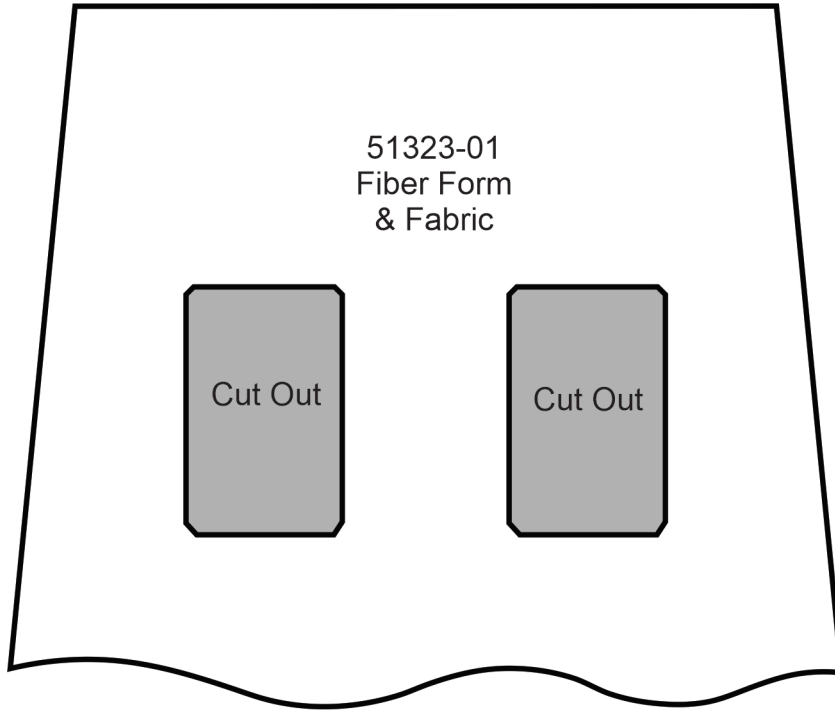

APPLIQUE PATTERNS

Print at 100%. No scaling. This box measures 1" x 1". Use the box as an accuracy guide when printing templates.

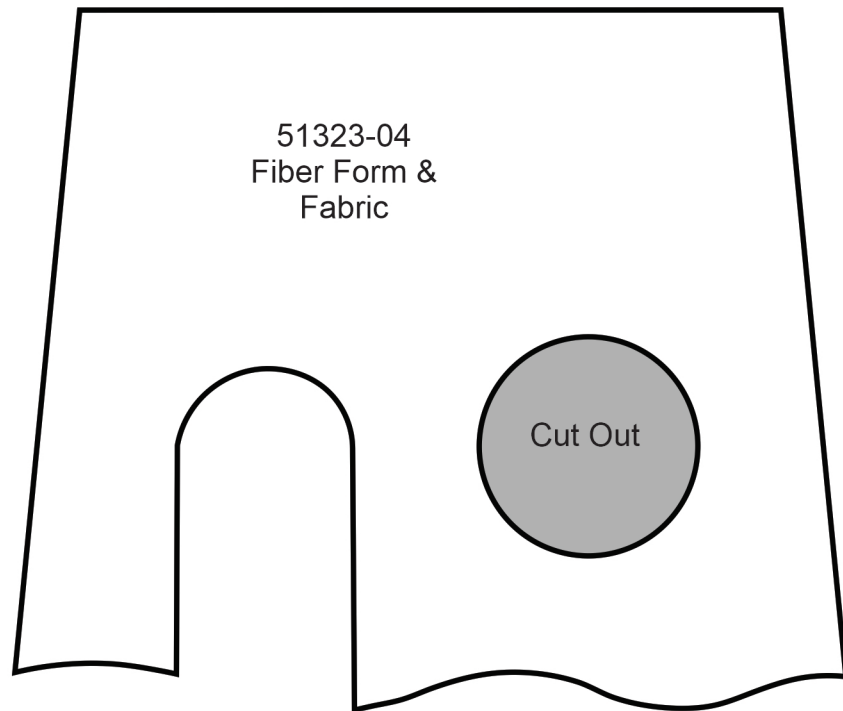
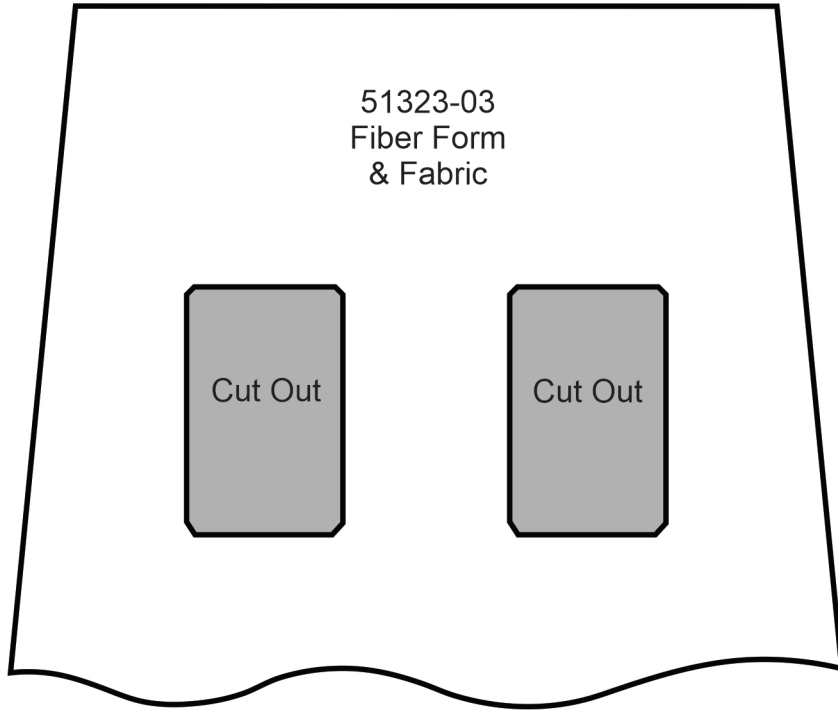

APPLIQUE PATTERNS

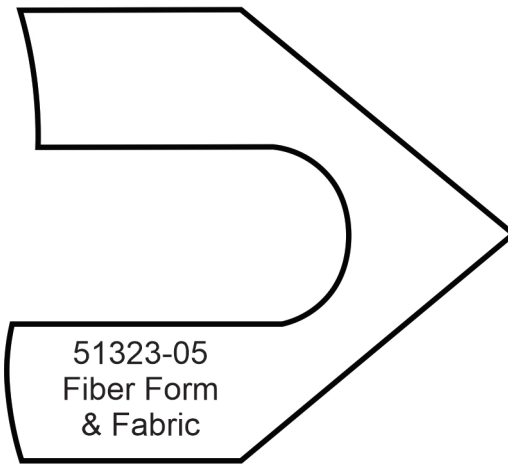
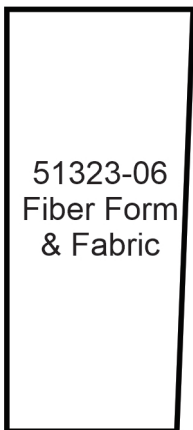

Print at 100%. No scaling. This box measures 1" x 1". Use the box as an accuracy guide when printing templates.

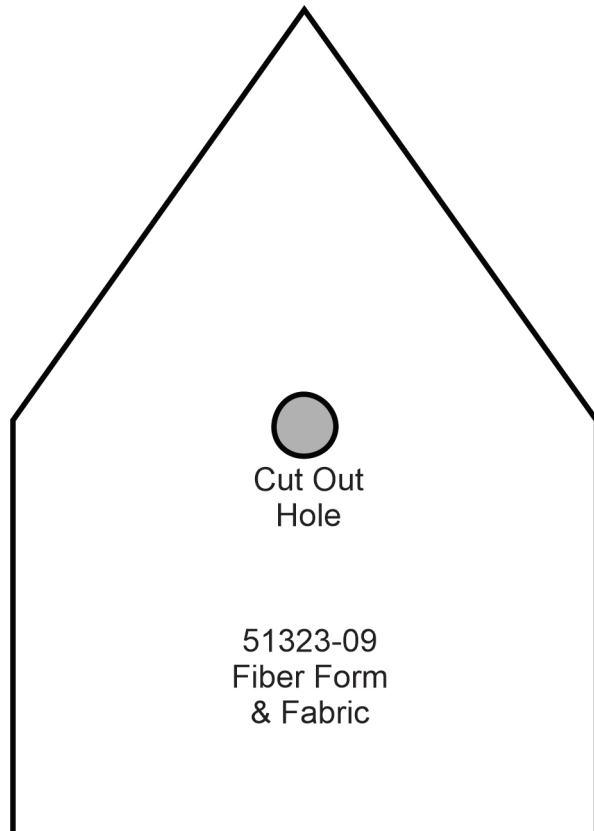
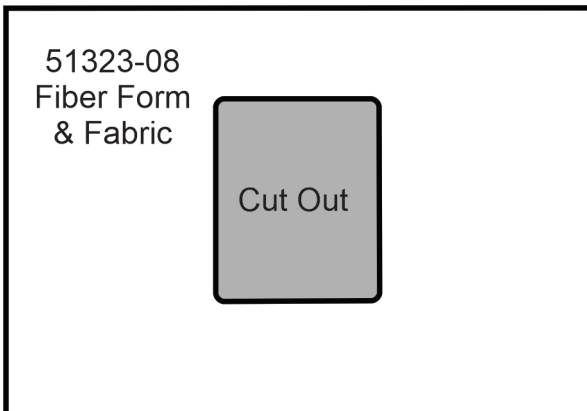

APPLIQUE PATTERNS

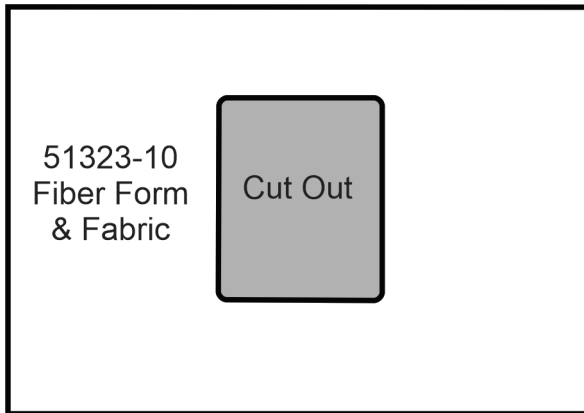

Print at 100%. No scaling. This box measures 1" x 1". Use the box as an accuracy guide when printing templates.

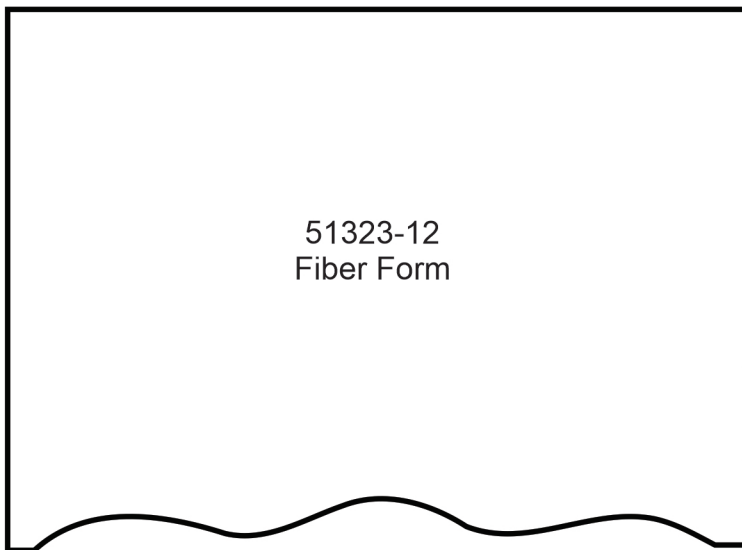
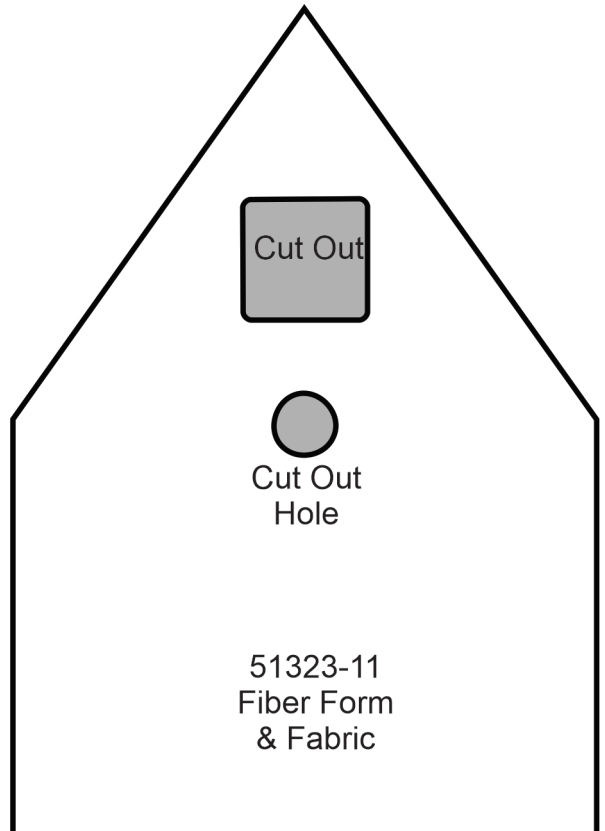
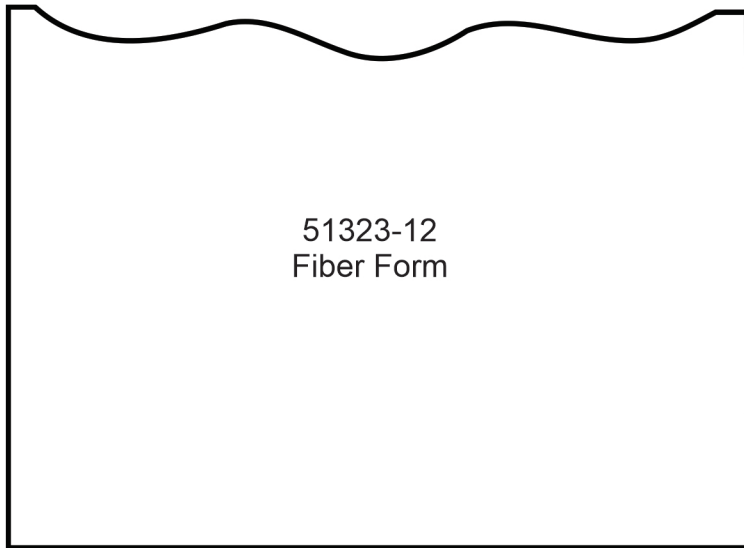

APPLIQUE PATTERNS



Print at 100%. No scaling. This box measures 1" x 1". Use the box as an accuracy guide when printing templates.

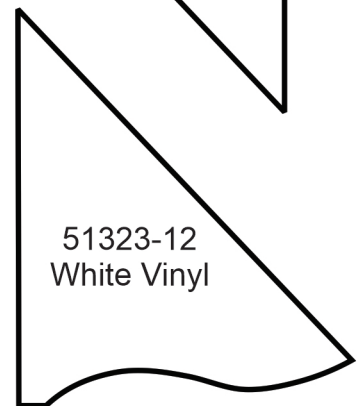
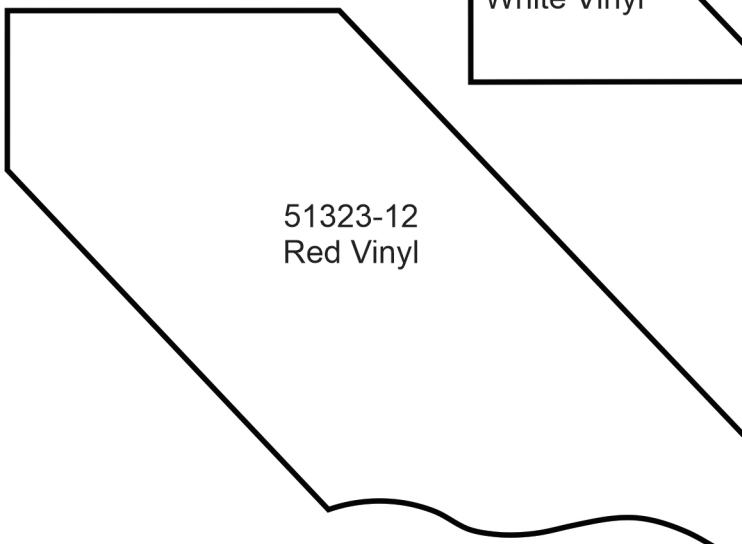
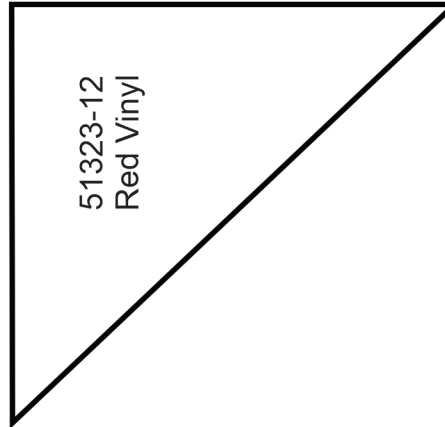
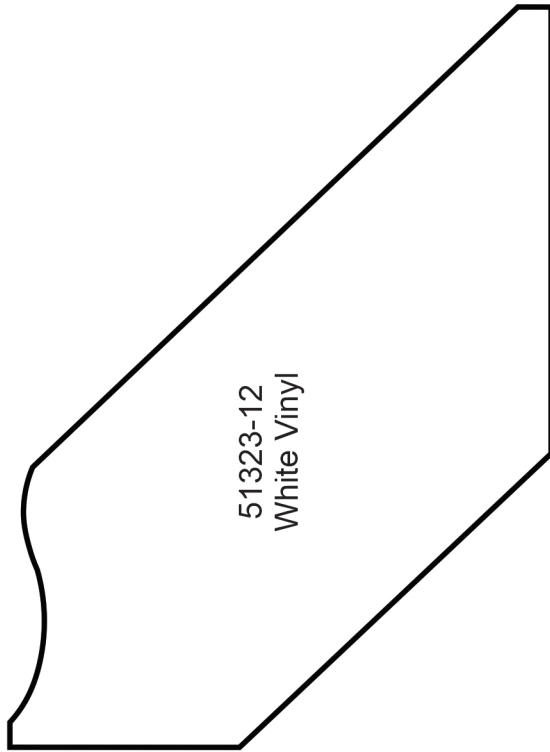

APPLIQUE PATTERNS



Print at 100%. No scaling. This box measures 1" x 1". Use the box as an accuracy guide when printing templates.

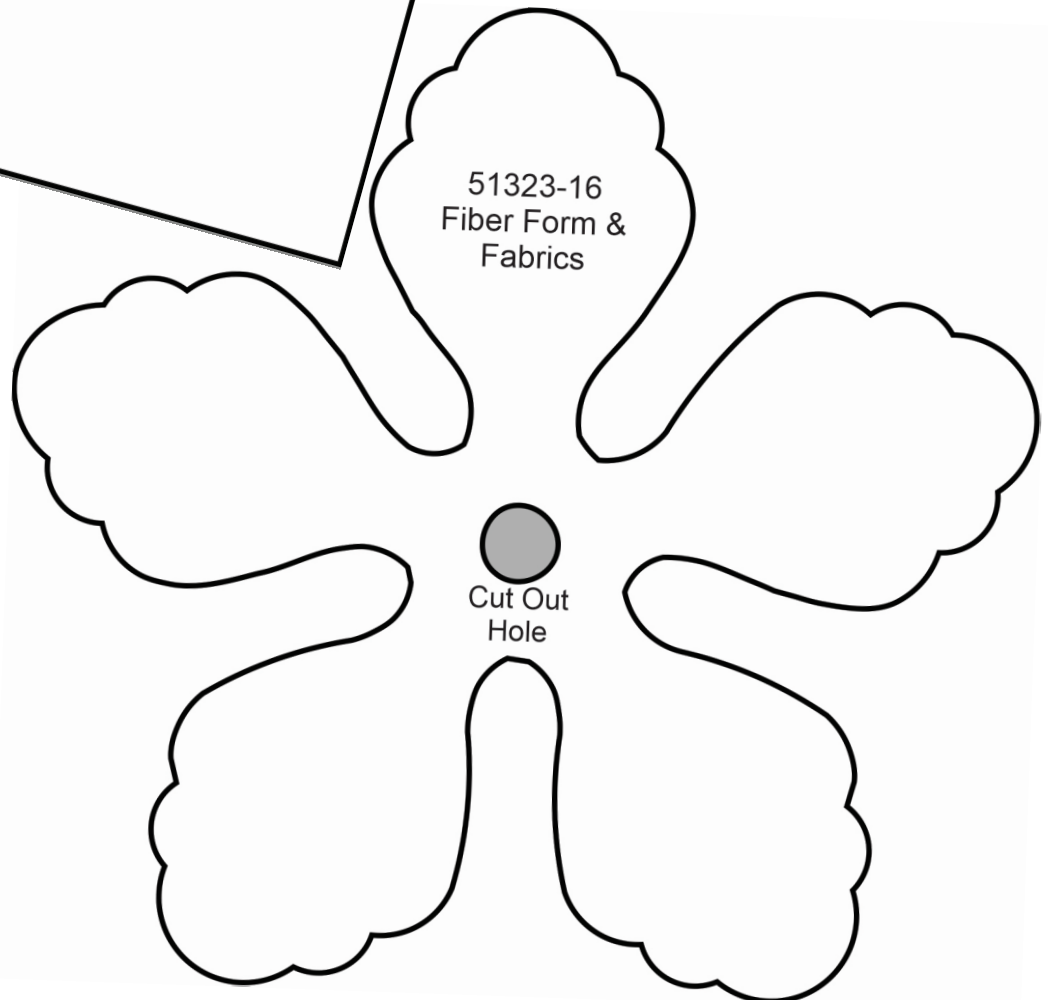
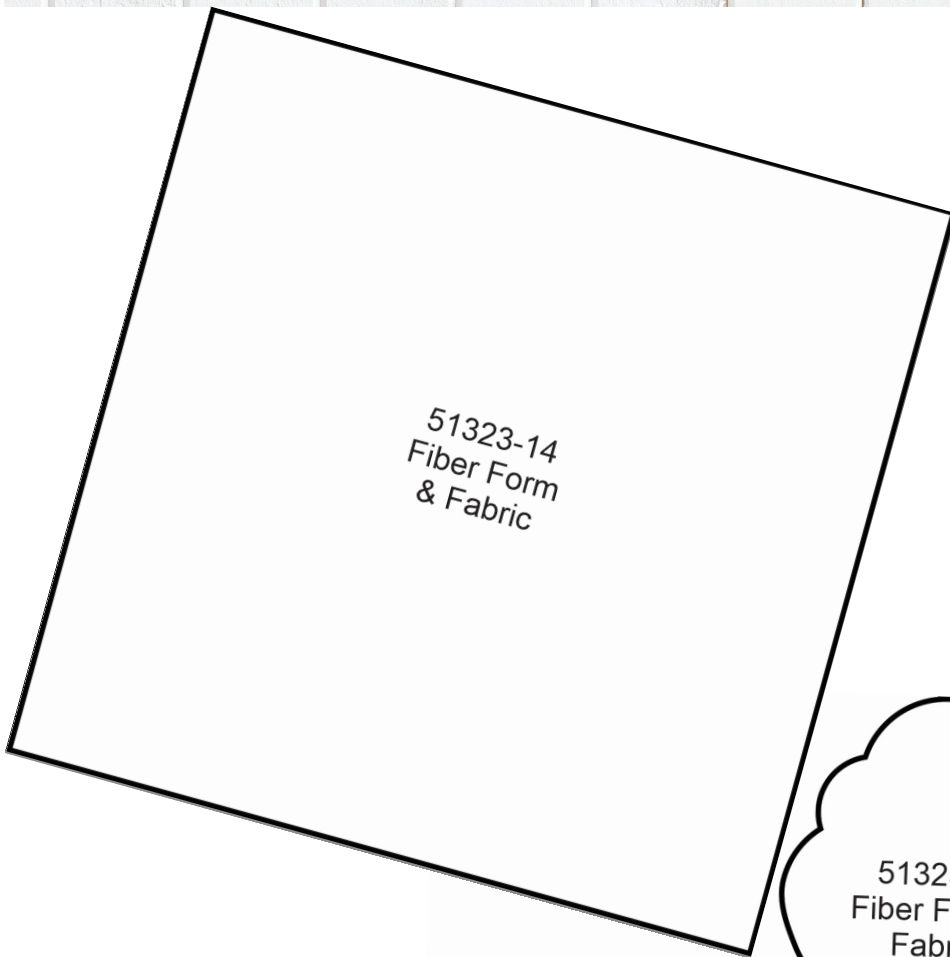

APPLIQUE PATTERNS

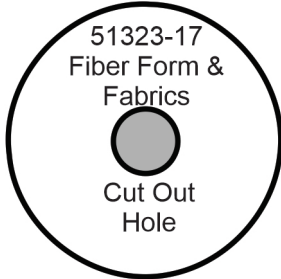

Print at 100%. No scaling. This box measures 1" x 1". Use the box as an accuracy guide when printing templates.

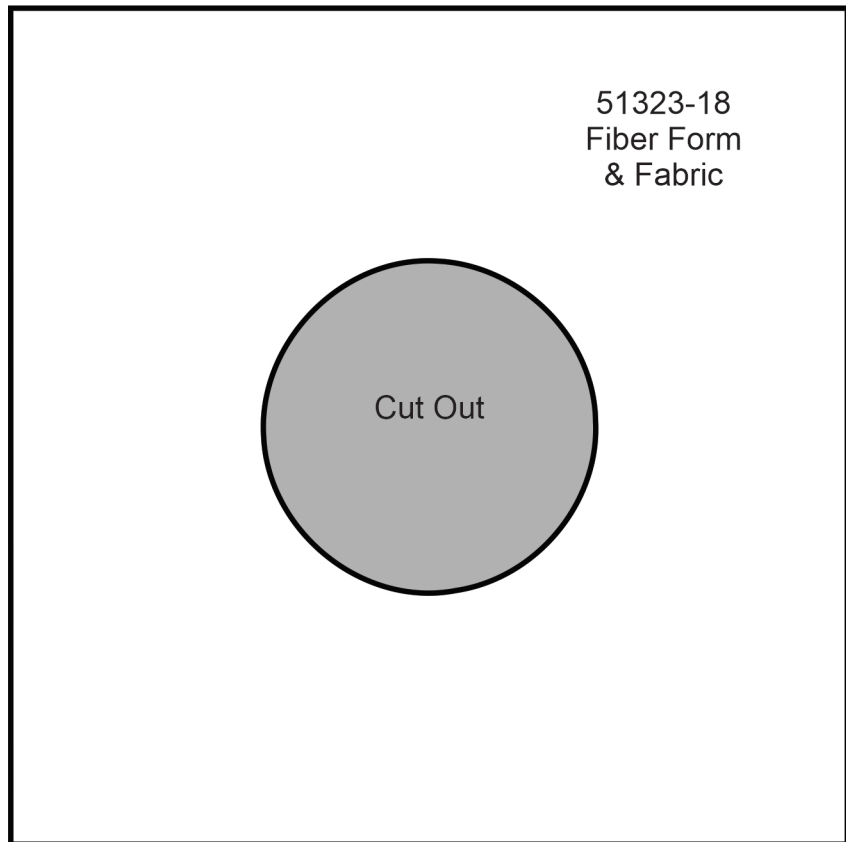

MIRRORED PATTERNS

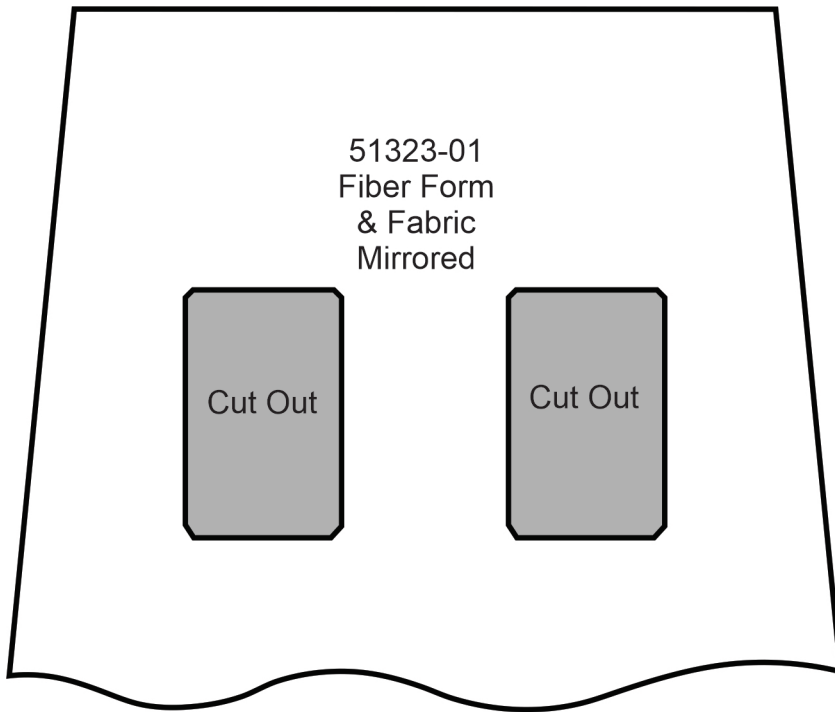

Print at 100%. No scaling. This box measures 1" x 1". Use the box as an accuracy guide when printing templates.

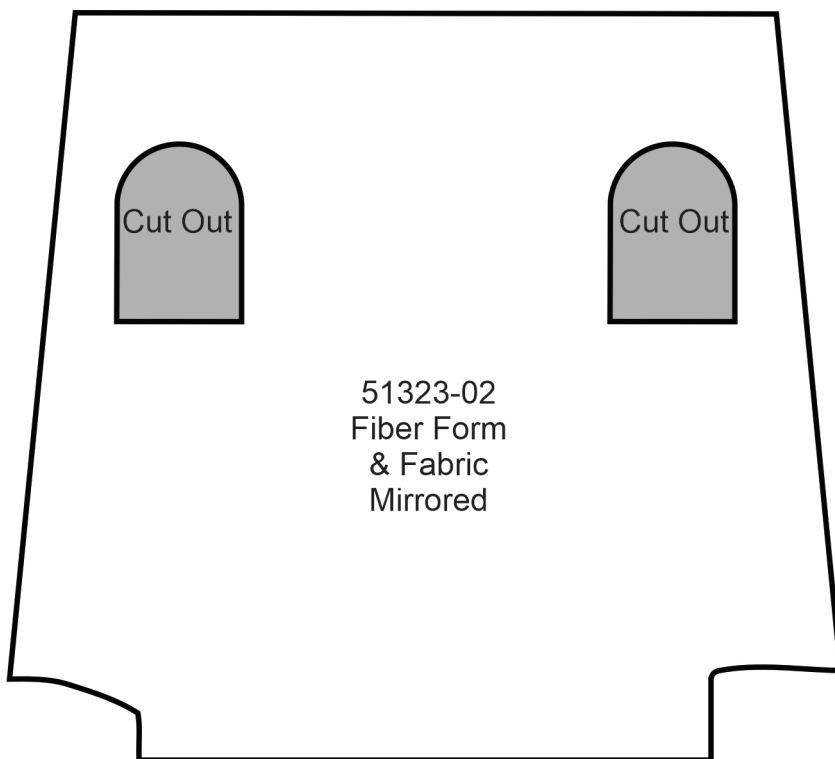

MIRRORED PATTERNS



Print at 100%. No scaling. This box measures 1" x 1". Use the box as an accuracy guide when printing templates.

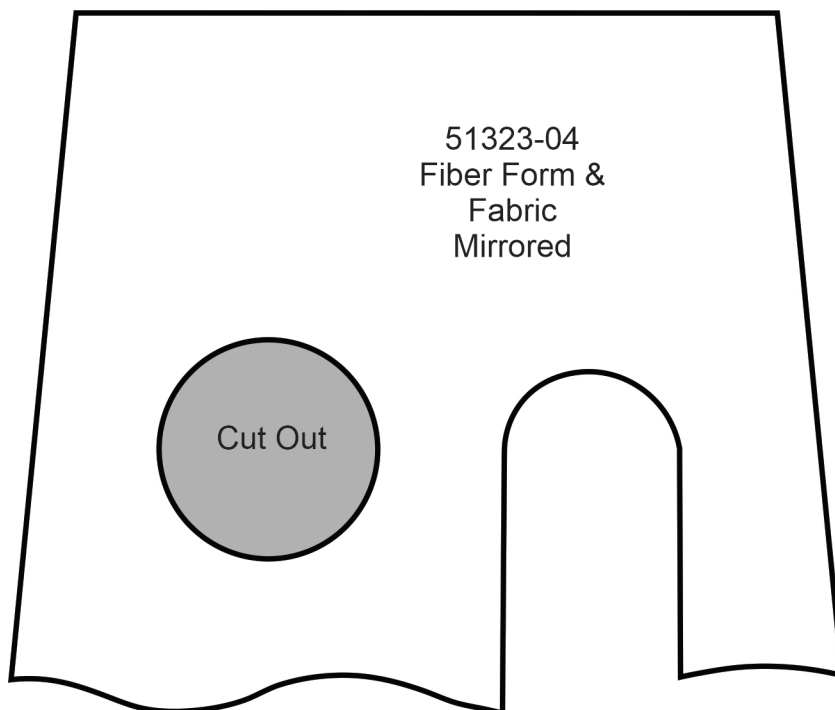
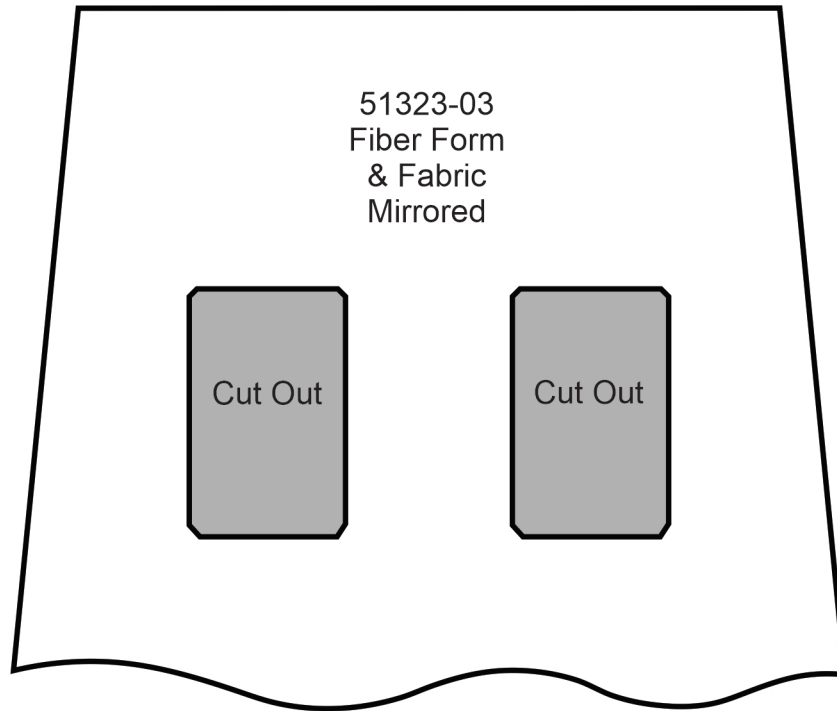

MIRRORED PATTERNS



Print at 100%. No scaling. This box measures 1" x 1". Use the box as an accuracy guide when printing templates.

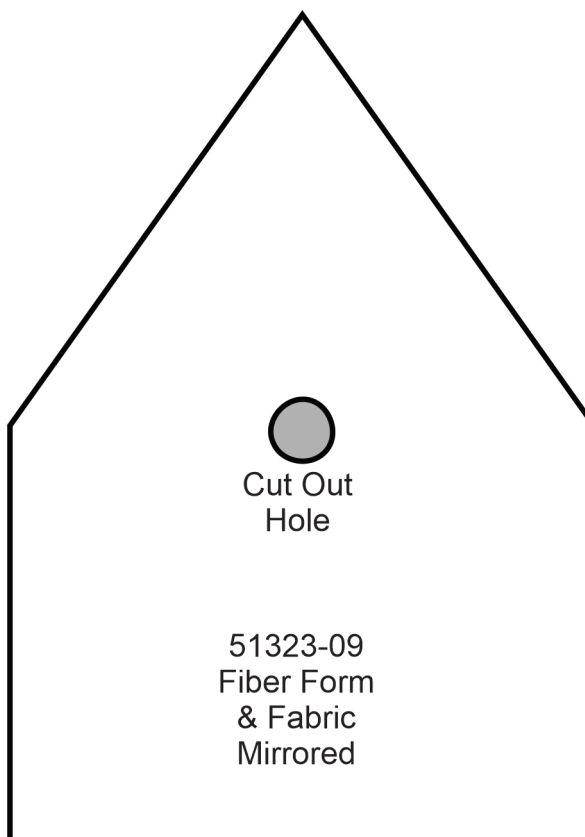
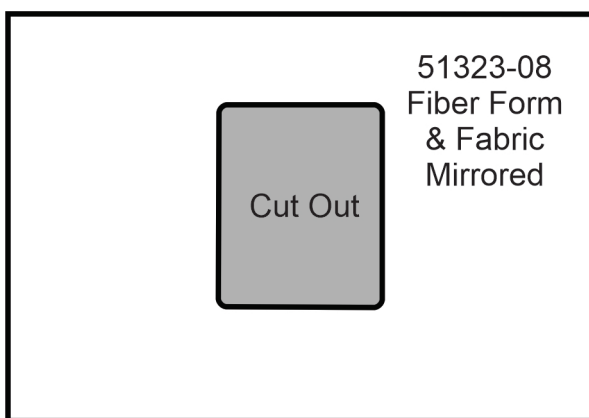
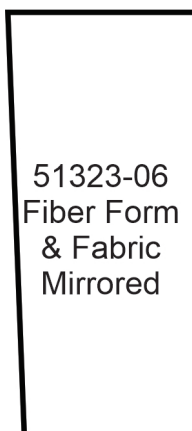
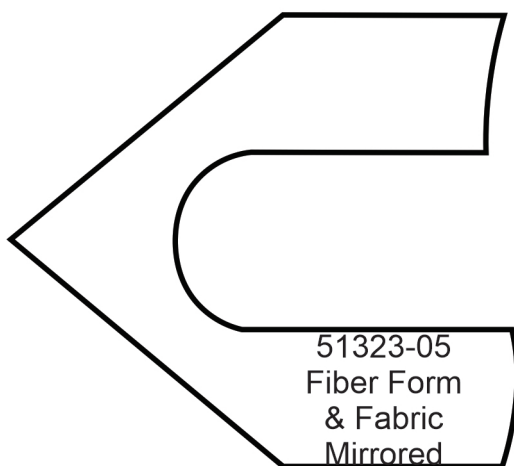
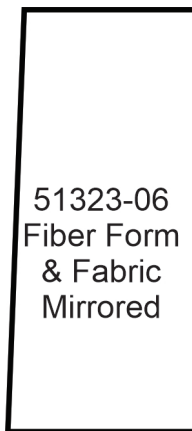

MIRRORED PATTERNS

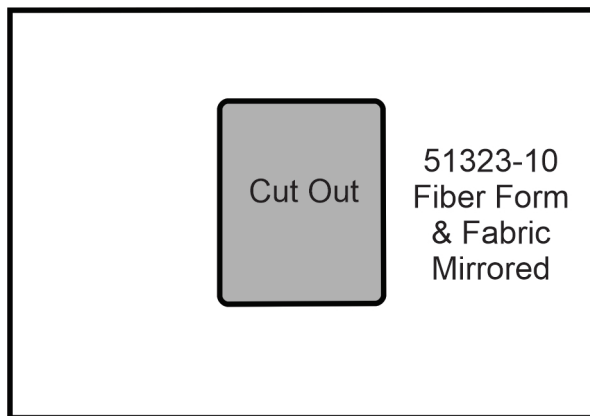

Print at 100%. No scaling. This box measures 1" x 1". Use the box as an accuracy guide when printing templates.

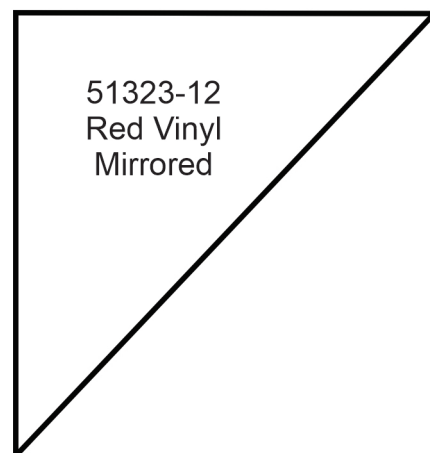
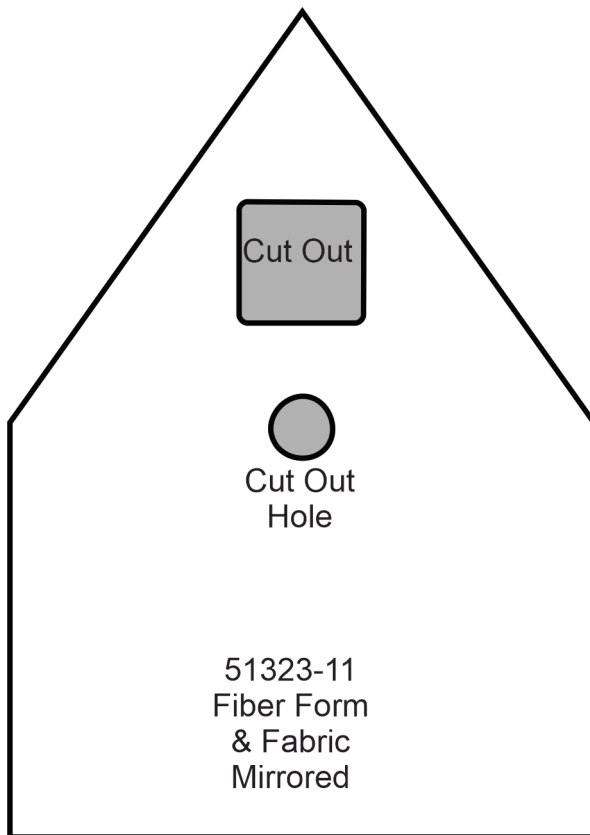

MIRRORED PATTERNS

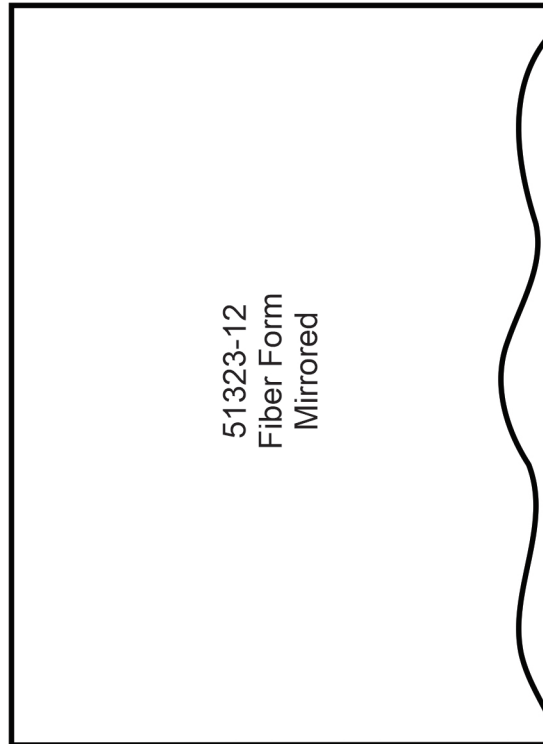
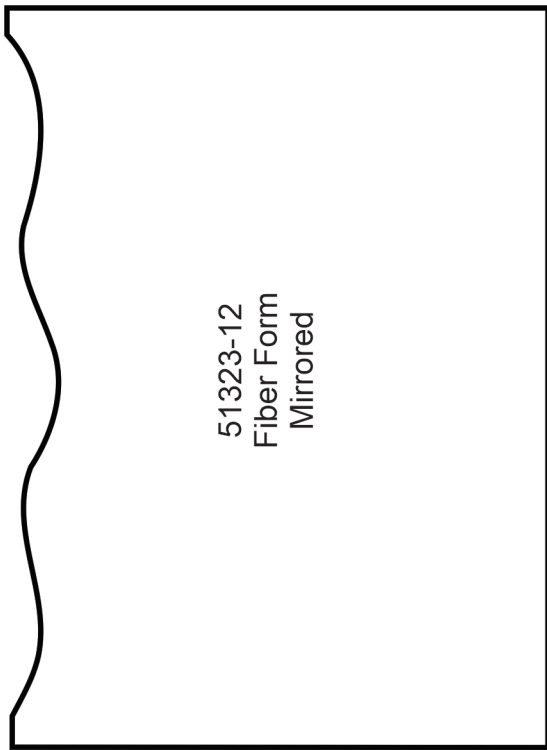

Print at 100%. No scaling. This box measures 1" x 1". Use the box as an accuracy guide when printing templates.

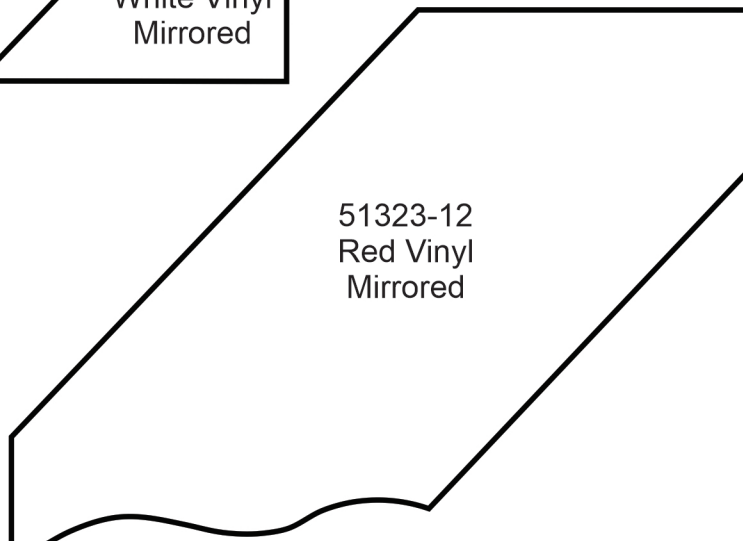
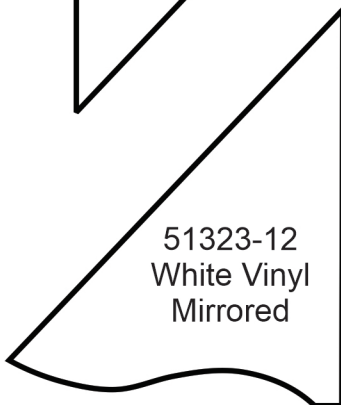
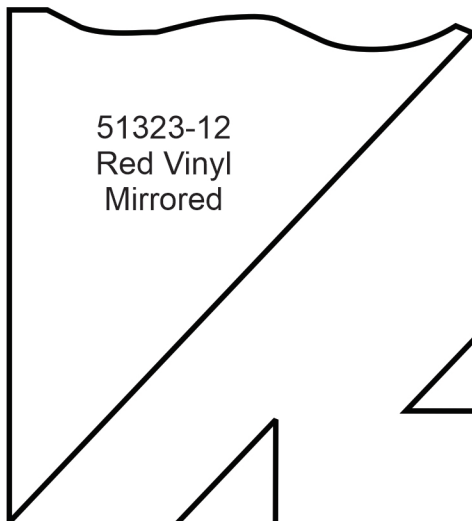

MIRRORED PATTERNS

Print at 100%. No scaling. This box measures 1" x 1". Use the box as an accuracy guide when printing templates.



51323-14
Fiber Form
& Fabric
Mirrored



51323-16
Fiber Form &
Fabrics
Mirrored



Cut Out
Hole

MIRRORED PATTERNS



Print at 100%. No scaling. This box measures 1" x 1". Use the box as an accuracy guide when printing templates.

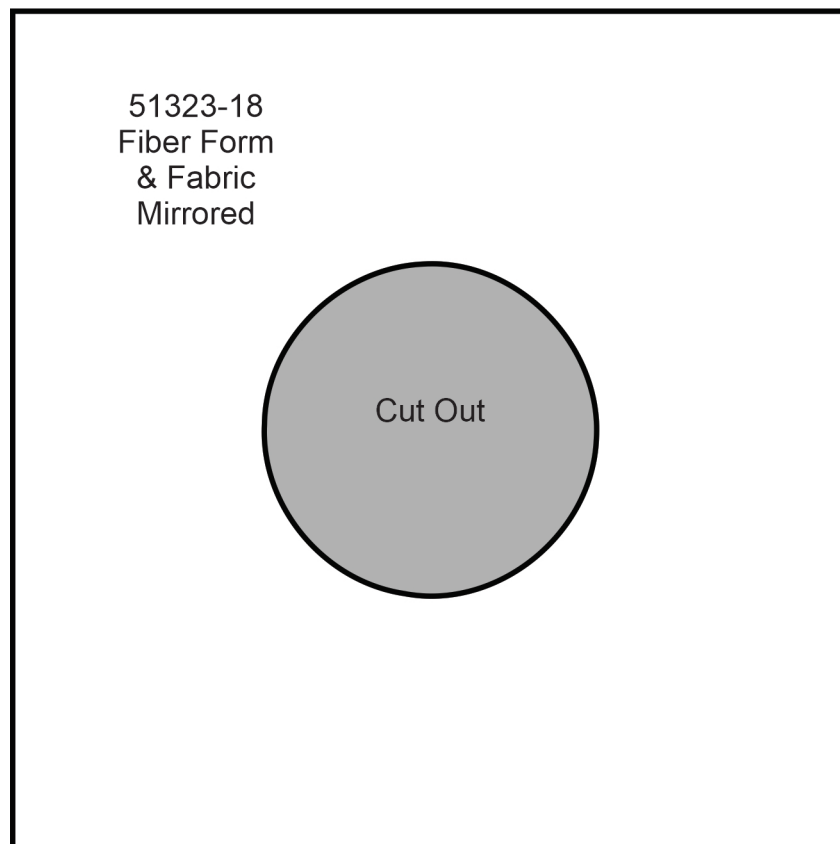

Note: Some designs in this collection may have been created using unique special stitches and/or techniques. To preserve design integrity when rescaling or rotating designs in your software, always rescale or rotate designs using the handles directly on-screen.

51323-01 Bottom Side Wall 1 FSA

Size Inches: Size mm: Stitch Count:

4.35 X 4.82 in. 110.49 X 122.43 mm 23553 St.

- 1.Fiber Form and Brown Fabric 1141
- 2.Cut Line and Tackdown..... 1141
- 3.Buttonettes and Linework..... 1141
- 4.Lace Detail..... 0015
- 5.Windows and Wall Detail..... 2530
- 6.Window Cover Stitch and Wall Detail..... 4430
- 7.Candy Detail..... 1900
- 8.Cover Stitch/ Lace and Wall Detail..... 0015



51323-02 Bottom Front Wall FSA

Size Inches: Size mm: Stitch Count:

4.35 X 4.52 in. 110.49 X 114.81 mm 17947 St.

- 1.Fiber Form and Brown Fabric 1141
- 2.Cut Line and Tackdown..... 1141
- 3.Buttonettes and Wall Detail..... 1141
- 4.Lace Detail..... 0015
- 5.Windows and Wall Detail..... 2530
- 6.Window Cover Stitch and Wall Detail..... 4430
- 7.Wall Detail..... 1900
- 8.Cover Stitch/ Lace and Wall Detail..... 0015











Note: Some designs in this collection may have been created using unique special stitches and/or techniques. To preserve design integrity when rescaling or rotating designs in your software, always rescale or rotate designs using the handles directly on-screen.

51323-03 Bottom Side Wall 2 FSA

Size Inches: Size mm: Stitch Count:

4.35 X 4.82 in. 110.49 X 122.43 mm 23545 St.













	1.Fiber Form and Brown Fabric	1141
	2.Cut Line and Tackdown.....	1141
	3.Buttonettes and Linework.....	1141
	4.Lace Detail.....	0015
	5.Windows and Wall Detail.....	2530
	6.Window Cover Stitch and Wall Detail.....	4430
	7.Wall Detail.....	1900
	8.Cover Stitch/ Lace and Wall Detail.....	0015

51323-04 Bottom Back Wall FSA

Size Inches: Size mm: Stitch Count:

4.35 X 4.82 in. 110.49 X 122.43 mm 22463 St.



	1.Fiber Form and Brown Fabric	1141
	2.Cut Line and Tackdown.....	1141
	3.White Vinyl Placement Stitch.....	1141
	4.Cut Line and Tackdown.....	1141
	5.Buttonettes and Linework.....	1141
	6.Lace and Wall Detail.....	0015
	7.Door Cover Stitch and Wall Detail.....	2530
	8.Window Cover Stitch and Wall Detail.....	4430
	9.Wall Detail.....	1900
	10.Cover Stitch/ Lace and Wall Detail.....	0015

Note: Some designs in this collection may have been created using unique special stitches and/or techniques. To preserve design integrity when rescaling or rotating designs in your software, always rescale or rotate designs using the handles directly on-screen.



51323-05 Front Door Walls FSA | 51

Size Inches: Size mm: Stitch Count:

6.41 X 3.00 in. 162.81 X 76.20 mm 21433 St.

- 1.Fiber Form and Brown Fabric1141
- 2.Cut Line and Tackdown.....1141
- 3.Red Vinyl Placement Stitch.....1141
- 4.Cut Line and Tackdown.....1141
- 5.Buttonettes and Linework.....1141
- 6.Wall Detail.....1900
- 7.Door Cover Stitch.....2530
- 8.Cover Stitch/ Lace and Wall Detail.....0015
- 9.Window Cover Stitch and Knob.....4430



51323-06 Front Door Roof FSA | 513

Size Inches: Size mm: Stitch Count:

4.62 X 2.69 in. 117.35 X 68.33 mm 13391 St.

- 1.Fiber Form and Brown Fabric1141
- 2.Cut Line and Tackdown.....1141
- 3.Roof Detail.....1141
- 4.Cover Stitch/ Lace and Roof Detail.....0015

Note: Some designs in this collection may have been created using unique special stitches and/or techniques. To preserve design integrity when rescaling or rotating designs in your software, always rescale or rotate designs using the handles directly on-screen.

51323-07 Front Door Snow FSL | 513

Size Inches: Size mm: Stitch Count:

2.26 X 3.24 in. 57.40 X 82.30 mm 9447 St.

1. Single Color Design.....0015



51323-08 Top Side Wall 1 FSA

Size Inches: Size mm: Stitch Count:

3.91 X 3.50 in. 99.31 X 88.90 mm 13482 St.

1. Fiber Form and Brown Fabric1141
 2. Cut Line and Tackdown.....1141
 3. Linework.....1141
 4. Window Lace.....0015
 5. Window and Wall Detail.....2530
 6. Window Cover Stitch.....4430
 7. Cover Stitch/ Lace and Wall Detail.....0015
 8. Wall Detail.....1900









Note: Some designs in this collection may have been created using unique special stitches and/or techniques. To preserve design integrity when rescaling or rotating designs in your software, always rescale or rotate designs using the handles directly on-screen.



51323-09 Top Front Wall FSA

Size Inches: Size mm: Stitch Count:

5.76 X 3.28 in. 146.30 X 83.31 mm 15424 St.









	1.Fiber Form and Brown Fabric	1141
	2.Cut Line and Tackdown.....	1141
	3.Hole and Linework.....	1141
	4.Wall Detail.....	2530
	5.Wall Detail.....	4430
	6.Buttonettes and Wall Detail.....	1900
	7.Cover Stitch/ Lace and Wall Detail.....	0015



51323-10 Top Side Wall 2 FSA

Size Inches: Size mm: Stitch Count:

3.91 X 3.50 in. 99.31 X 88.90 mm 13482 St.

	1.Fiber Form and Brown Fabric	1141
	2.Cut Line and Tackdown.....	1141
	3.Linework.....	1141
	4.Window Lace	0015
	5.Window and Wall Detail.....	2530
	6.Window Cover Stitch.....	4430
	7.Cover Stitch/ Lace and Wall Detail.....	0015
	8.Wall Detail.....	1900









Note: Some designs in this collection may have been created using unique special stitches and/or techniques. To preserve design integrity when rescaling or rotating designs in your software, always rescale or rotate designs using the handles directly on-screen.



51323-11 Top Back Wall FSA

Size Inches: Size mm: Stitch Count:

5.76 X 3.48 in. 146.30 X 88.39 mm 17634 St.

	1.Fiber Form and Brown Fabric	1141
	2.Cut Line and Tackdown.....	1141
	3.Linework and Hole.....	1141
	4.Window Lace.....	0015
	5.Window and Wall Detail.....	2530
	6.Window Cover Stitch and Wall Detail.....	4430
	7.Buttonettes and Wall Detail.....	1900
	8.Cover Stitch/ Lace and Wall Detail.....	0015



51323-12 Roof FSA | 51323-12

Size Inches: Size mm: Stitch Count:

6.76 X 4.57 in. 171.70 X 116.08 mm 36716 St.

	1.Fiber Form Placement Stitch.....	1141
	2.Fiber Form Tackdown.....	1141
	3.Red Vinyl Placement Stitch.....	1141
	4.Cut Line and Tackdown.....	1141
	5.White Vinyl Placement Stitch.....	1141
	6.Cut Line and Tackdown.....	1141
	7.Roof Detail.....	1141
	8.Roof Detail.....	2530
	9.Cover Stitch and Detail.....	1900
	10.Cover Stitch/ Lace and Roof Detail.....	0015
	11.Linework.....	1141
	12.Linework.....	2530
	13.Linework.....	4430

Note: Some designs in this collection may have been created using unique special stitches and/or techniques. To preserve design integrity when rescaling or rotating designs in your software, always rescale or rotate designs using the handles directly on-screen.

51323-13 Roof Snow FSL

Size Inches: Size mm: Stitch Count:

4.56 X 4.23 in. 115.82 X 107.44 mm 22863 St.

1. Single Color Design.....0015



51323-14 Platform FSA | 51323-14

Size Inches: Size mm: Stitch Count:

5.68 X 5.68 in. 144.27 X 144.27 mm 42060 St.

1. Fiber Form and Brown Fabric1141
 2. Cut Line and Tackdown.....1141
 3. Linework and Platform Detail.....1141
 4. Cover Stitch/ Lace and Platform0015
 5. Platform Detail.....4430
 6. Platform Detail.....2530
 7. Platform Detail.....1900

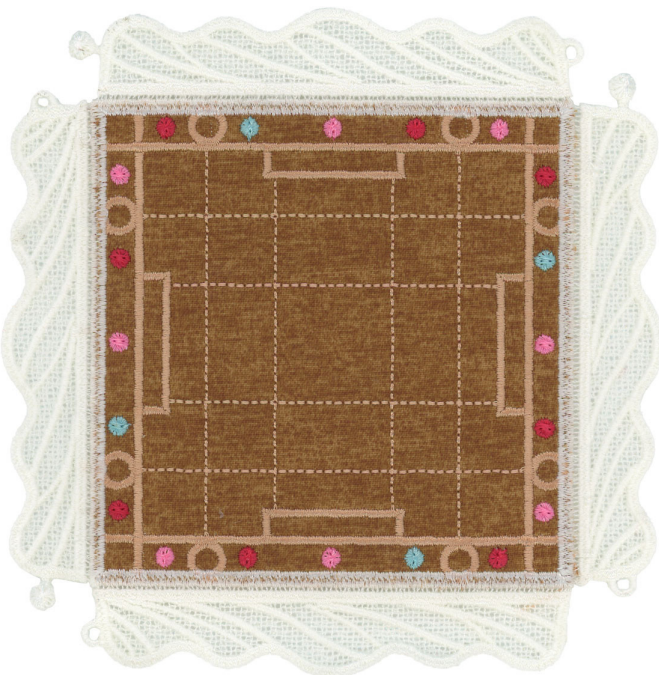

Note: Some designs in this collection may have been created using unique special stitches and/or techniques. To preserve design integrity when rescaling or rotating designs in your software, always rescale or rotate designs using the handles directly on-screen.

51323-15 Back Blades Holder FSL

Size Inches: Size mm: Stitch Count:
2.29 X 2.38 in. 58.17 X 60.45 mm 7843 St.

1. Single Color Design.....0015



51323-16 Blades FSA

Size Inches: Size mm: Stitch Count:
5.22 X 5.44 in. 132.59 X 138.18 mm 30040 St.

1. Fiber Form/Front and Back Brown2530
 2. Cut Line and Tackdown.....2530
 3. Blade Detail.....2530
 4. Blade Detail.....4430
 5. Blade Detail.....1900
 6. Cut Line and Tackdown.....1141
 7. Cover Stitch.....1141
 8. Cover Stitch and Blades Detail.....0015









Note: Some designs in this collection may have been created using unique special stitches and/or techniques. To preserve design integrity when rescaling or rotating designs in your software, always rescale or rotate designs using the handles directly on-screen.

51323-17 Front Blades Washer FSA

Size Inches: Size mm: Stitch Count:

1.51 X 1.51 in. 38.35 X 38.35 mm 3581 St.





	1.Fiber Form and Brown Fabric	1141
	2.Cut Line and Tackdown.....	1141
	3.Cover Stitch.....	1141
	4.Cover Stitch.....	2530
	5.Linework.....	1900
	6.Washer Detail.....	0015



51323-18 Foundation FSA | 51323-18

Size Inches: Size mm: Stitch Count:

5.17 X 5.17 in. 131.32 X 131.32 mm 11753 St.

	1.Fiber Form and Brown Fabric	1141
	2.Cut Line and Tackdown.....	1141
	3.Foundation Detail.....	1141
	4.Cover Stitch/ Lace and Foundation	0015

