



Scissortail  
STITCHES

#51240

44 Files / 11 DESIGNS



# IN THE HOOP POCKET PEEKERS COLLECTION

It is a violation of Copyright law to make and distribute copies of electronic designs or artwork.  
Electronic designs are licensed to the original purchaser for use at one location. ©2020 OESD, LLC. All rights reserved.

# MATERIALS



## Isacord Thread Colors

0010 Silky White  
0020 Black  
0131 Smoke  
0132 Dark Pewter  
0504 Mimosa  
0630 Buttercup  
0811 Candlelight  
0934 Fawn  
1322 Dirty Penny  
1332 Harvest  
1521 Flamingo  
1725 Terra Cotta  
1913 Cherry  
2123 Bordeaux  
2160 Iced Pink  
2508 Hot Pink  
2520 Garden Rose  
2532 Pretty in Pink  
2550 Soft Pink  
2830 Wild Iris  
2920 Purple  
3151 Blue Dawn  
3641 Wedgewood  
3743 Harbor  
3750 Winter Frost  
3810 Laguna  
3910 Crystal Blue  
3963 Hint of Blue  
4620 Jade  
4752 Vintage Blue  
5230 Bottle Green  
5450 Basic Seafoam  
5633 Lime  
5832 Celery



# DESIGNS



Note: Some designs in this collection may have been created using unique special stitches and/or techniques. To preserve design integrity when rescaling or rotating designs in your software, always rescale or rotate designs using the handles directly on-screen.

## FABRIC REQUIRED



### 51240-01 Stitch 'N' Turn UFO Pocket Large

Size Inches: **4.58 X 4.49 in.**      Size mm: **116.3 X 114.0 mm**      Stitch Count: **8798 St.**

- 1. Fabric Placement Stitch ..... 0020
- 2. Fabric Tackdown ..... 0020
- 3. Trees ..... 0020
- 4. Beam ..... 3963
- 5. White Spots ..... 0010
- 6. Cow ..... 0020
- 7. Beam Outline ..... 0010
- 8. Stars ..... 0504
- 9. Seam Stitch Match Fabric ..... 0020

### 51240-02 UFO Pocket Placement Large

Size Inches: **6.99 X 4.00 in.**      Size mm: **177.5 X 101.6 mm**      Stitch Count: **5708 St.**

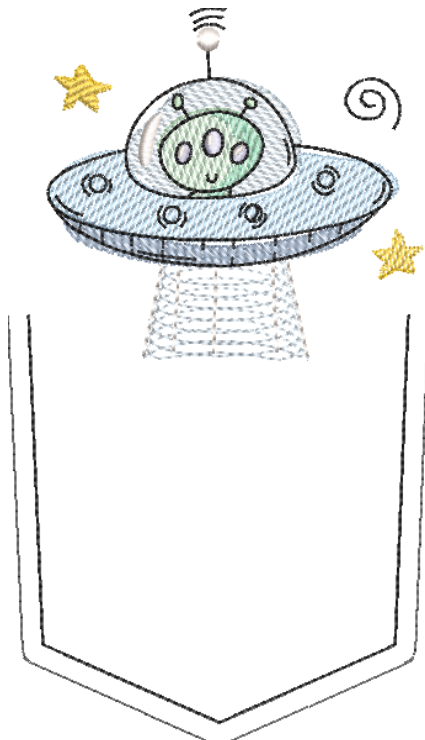

- 1. Beam ..... 3963
- 2. Beam Outlines ..... 0010
- 3. Dark Blue Ship Detail ..... 3810
- 4. Medium Blue Ship Detail ..... 3910
- 5. Light Blue Ship Detail ..... 3963
- 6. Light Green Alien Shading ..... 5450
- 7. Dark Green Alien Shading ..... 5230
- 8. Purple Eyes ..... 3151
- 9. Black Ship Outlines ..... 0020
- 10. White Highlights ..... 0010
- 11. Stars ..... 0504
- 12. Pocket Placement Stitch Match Fabric. 0020
- 13. Pocket Tackdown Match Fabric ..... 0020

# DESIGNS



Note: Some designs in this collection may have been created using unique special stitches and/or techniques. To preserve design integrity when rescaling or rotating designs in your software, always rescale or rotate designs using the handles directly on-screen.

## FABRIC REQUIRED

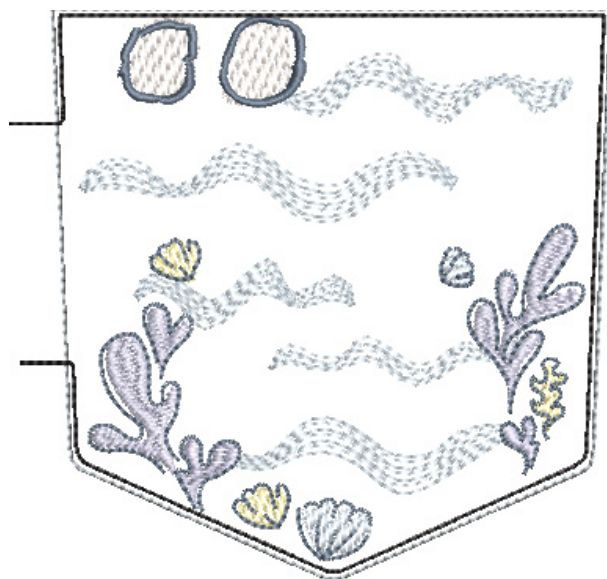

### 51240-03 Stitch 'N' Turn MerCat Pocket Large

Size Inches:                      Size mm:                      Stitch Count:  
**4.23 X 4.49 in.**            **107.4 X 114.0 mm**            **5765 St.**

- 1. Fabric Placement Stitch .....3963
- 2. Fabric Tackdown .....3963
- 3. Blue Waves and Shells .....3963
- 4. Purple Coral.....3151
- 5. Yellow Shells .....0630
- 6. Paws ..... 0010
- 7. Design Outlines ..... 3743
- 8. Seam Stitch Match Fabric .....0020

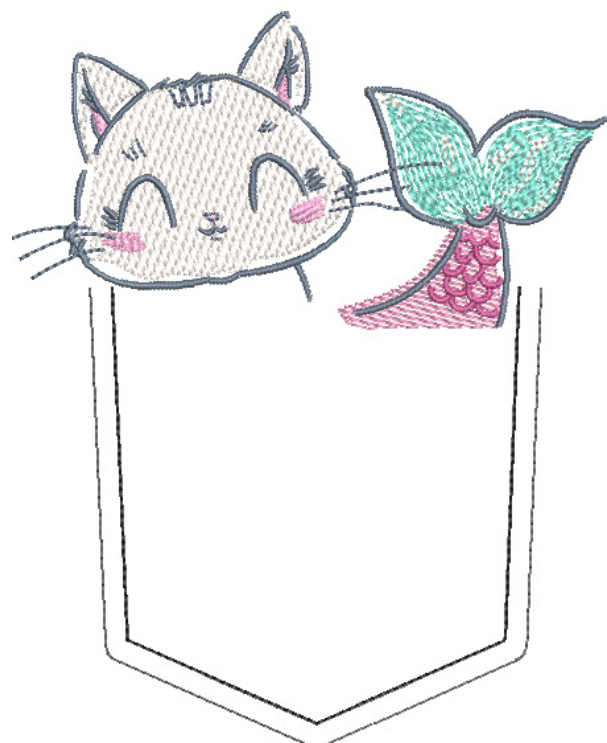

### 51240-04 MerCat Pocket Placement Large

Size Inches:                      Size mm:                      Stitch Count:  
**6.52 X 5.26 in.**            **165.6 X 133.6 mm**            **7620 St.**

- 1. Medium Pink Tail Detail..... 2532
- 2. Dark Pink Tail Detail..... 2508
- 3. Blue Tail Detail ..... 4620
- 4. White Head and Tail Detail..... 0010
- 5. Light Pink Ears and Cheeks..... 2550
- 6. Design Outlines ..... 3743
- 7. Pocket Placement Stitch Match Fabric.0020
- 8. Pocket Tackdown Match Fabric.....0020

# DESIGNS



Note: Some designs in this collection may have been created using unique special stitches and/or techniques. To preserve design integrity when rescaling or rotating designs in your software, always rescale or rotate designs using the handles directly on-screen.

## FABRIC REQUIRED

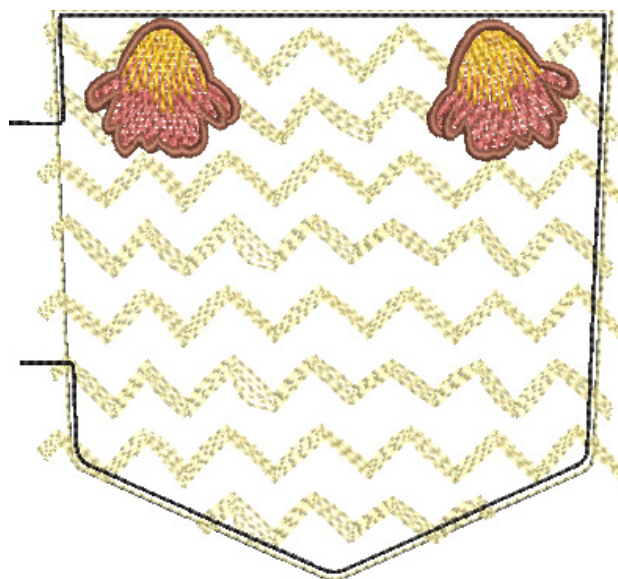

### 51240-05 Stitch 'N' Turn Monster Pocket Large

Size Inches:                      Size mm:                      Stitch Count:  
**4.23 X 4.55 in.**            **107.4 X 115.6 mm**            **6747 St.**

- 1. Fabric Placement Stitch.....0630
- 2. Fabric Tackdown .....0630
- 3. Yellow Zig Zags.....0630
- 4. Dark Orange Fur Shading.....1332
- 5. Light Orange Fur Shading.....0811
- 6. Brown Outlines.....1322
- 7. Seam Stitch Match Fabric.....0020

### 51240-06 Monster Pocket Placement Large

Size Inches:                      Size mm:                      Stitch Count:  
**6.80 X 4.00 in.**            **172.7 X 101.6 mm**            **9122 St.**

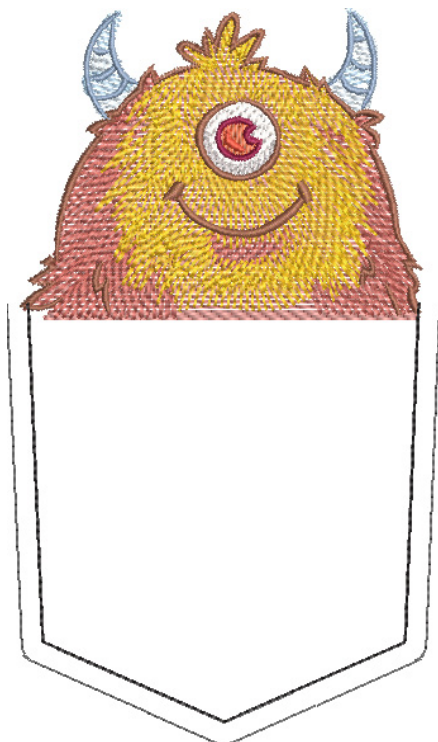

- 1. Dark Orange Fur Shading.....1332
- 2. Light Orange Fur Shading.....0811
- 3. Light Blue Horn Shading.....3963
- 4. Medium Blue Horn Shading.....3910
- 5. Dark Blue Horn Shading.....3810
- 6. White Eye Shading.....0010
- 7. Gray Eye Shading.....0131
- 8. Medium Red Eye Shading.....1913
- 9. Light Red Eye Shading.....1521
- 10. Dark Red Eye Shading.....2123
- 11. Brown Outlines.....1322
- 12. Pocket Placement Stitch Match Fabric.0020
- 13. Pocket Tackdown Match Fabric.....0020



# DESIGNS



Note: Some designs in this collection may have been created using unique special stitches and/or techniques. To preserve design integrity when rescaling or rotating designs in your software, always rescale or rotate designs using the handles directly on-screen.

## FABRIC REQUIRED

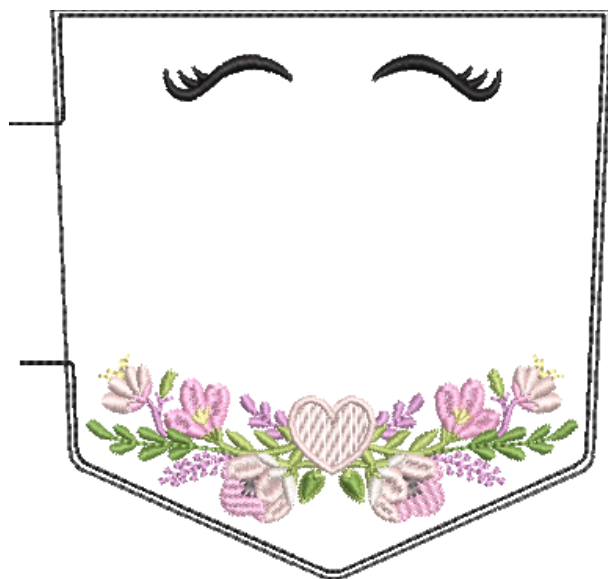

### 51240-07 Stitch 'N' Turn Unicorn Pocket Large

Size Inches:                      Size mm:                      Stitch Count:  
**4.23 X 4.49 in.**            **107.4 X 114.0 mm**            **6284 St.**

- 1. Fabric Placement Stitch ..... 0020
- 2. Fabric Tackdown ..... 0020
- 3. Eyes ..... 0020
- 4. Purple Detail ..... 2830
- 5. Light Green Detail ..... 5832
- 6. Dark Pink Detail ..... 2550
- 7. Light Pink Detail ..... 2160
- 8. White Detail ..... 0010
- 9. Dark Green Detail ..... 5633
- 10. Gray Detail ..... 0132
- 11. Yellow Detail ..... 0630
- 12. Seam Stitch Match Fabric ..... 0020

### 51240-08 Unicorn Pocket Placement Large

Size Inches:                      Size mm:                      Stitch Count:  
**6.86 X 4.00 in.**            **174.2 X 101.6 mm**            **3652 St.**



- 1. Dark Pink Horn Detail ..... 2550
- 2. Orange Horn Detail ..... 0811
- 3. Yellow Horn Detail ..... 0630
- 4. Blue Horn Detail ..... 3910
- 5. Light Purple Horn Detail ..... 2830
- 6. Dark Purple Horn Detail ..... 2920
- 7. Blue Flower and Heart ..... 3910
- 8. Pink Heart ..... 2160
- 9. Orange Flower ..... 0811
- 10. Yellow Stars and Flower ..... 0630
- 11. Green Leaves and Flower Detail ..... 5832
- 12. Gray Stamens ..... 0132
- 13. Ears ..... 2160
- 14. Pocket Placement Stitch Match Fabric. 0020
- 15. Pocket Tackdown Match Fabric ..... 0020

# DESIGNS



Note: Some designs in this collection may have been created using unique special stitches and/or techniques. To preserve design integrity when rescaling or rotating designs in your software, always rescale or rotate designs using the handles directly on-screen.

## FABRIC REQUIRED

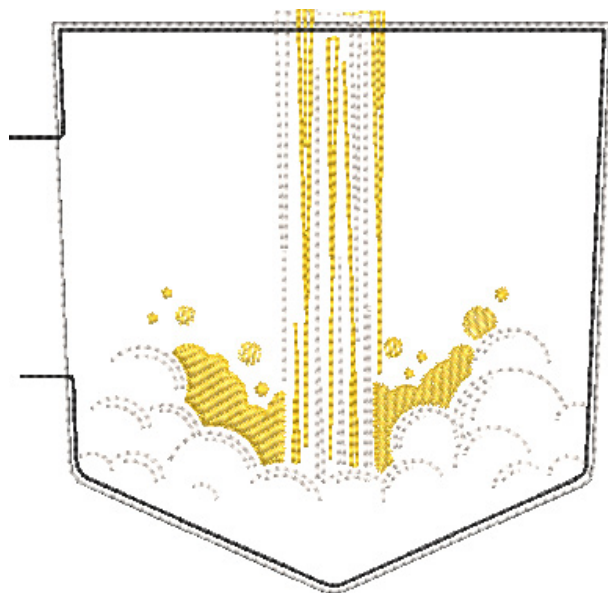

### 51240-09 Stitch 'N' Turn Rocket Pocket Large

Size Inches:                      Size mm:                      Stitch Count:  
**4.35 X 4.49 in.**            **110.5 X 114.0 mm**            **4532 St.**

- 1. Fabric Placement Stitch ..... 0010
- 2. Tackdown ..... 0010
- 3. White Detail ..... 0010
- 4. Orange Detail ..... 0811
- 5. Seam Stitch Match Fabric ..... 0020

### 51240-10 Rocket Pocket Placement Large

Size Inches:                      Size mm:                      Stitch Count:  
**7.42 X 4.00 in.**            **188.5 X 101.6 mm**            **5559 St.**

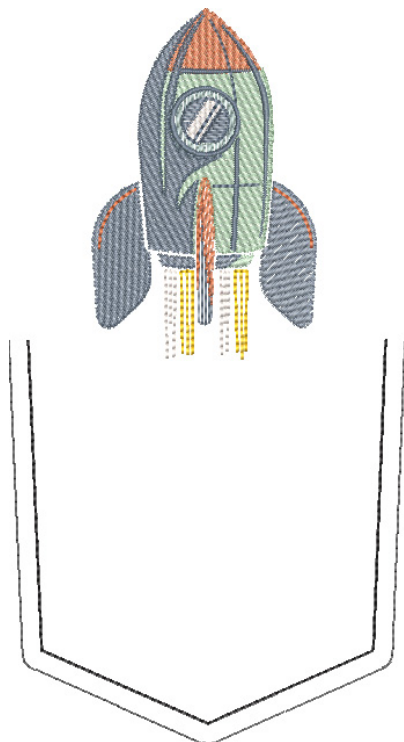

- 1. White Smoke ..... 0010
- 2. Orange Smoke ..... 0811
- 3. Light Green Rocket Detail ..... 5450
- 4. Dark Green Rocket Detail ..... 4752
- 5. Red Rocket Nose ..... 1725
- 6. White Window Detail ..... 0010
- 7. Blue Rocket Detail ..... 3743
- 8. Red Fin Detail ..... 1725
- 9. Pocket Placement Stitch Match Fabric. 0020
- 10. Pocket Tackdown Match Fabric ..... 0020

# DESIGNS



Note: Some designs in this collection may have been created using unique special stitches and/or techniques. To preserve design integrity when rescaling or rotating designs in your software, always rescale or rotate designs using the handles directly on-screen.

## FABRIC REQUIRED

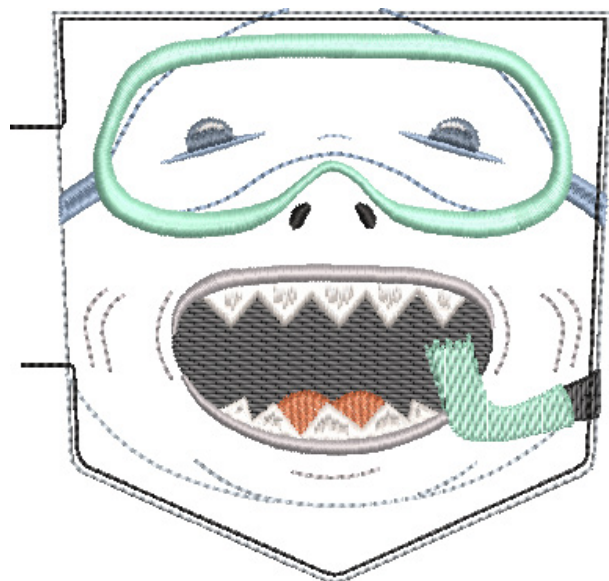

### 51240-11 Stitch 'N' Turn Shark Pocket Large

Size Inches:                      Size mm:                      Stitch Count:  
**4.27 X 4.49 in.**            **108.5 X 114.0 mm**            **7079 St.**

- 1. Fabric Placement Stitch .....3750
- 2. Fabric Tackdown .....3750
- 3. Light Blue Detail.....3750
- 4. Medium Blue Detail ..... 3810
- 5. Dark Blue Detail ..... 3743
- 6. Black Detail ..... 0020
- 7. Red Detail ..... 1725
- 8. Green Detail ..... 5230
- 9. White Detail..... 0010
- 10. Gray Detail ..... 0131
- 11. Seam Stitch Match Fabric ..... 0020

### 51240-12 Shark Pocket Placement Large

Size Inches:                      Size mm:                      Stitch Count:  
**6.25 X 5.40 in.**            **158.8 X 137.2 mm**            **2734 St.**

- 1. Light Blue Detail.....3750
- 2. Medium Blue Detail ..... 3810
- 3. Black Detail ..... 0020
- 4. Green Detail ..... 5230
- 5. Pocket Placement Stitch Match Fabric. 0020
- 6. Pocket Tackdown Match Fabric..... 0020

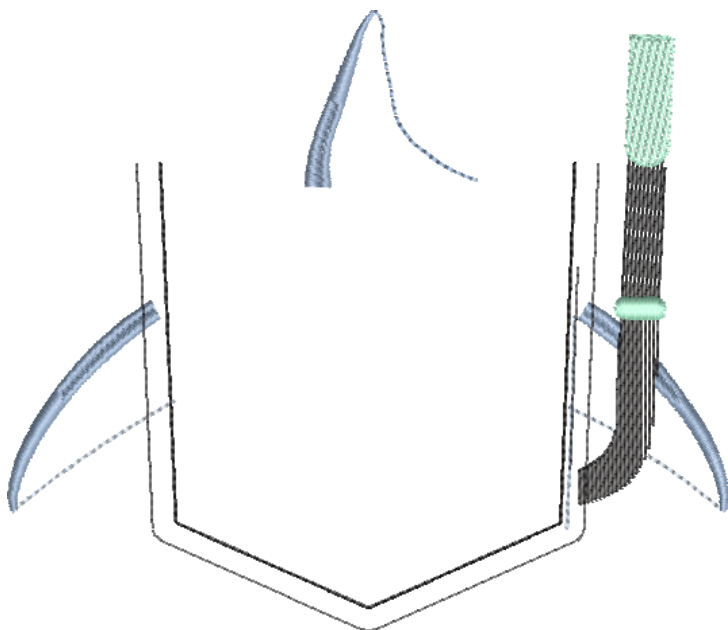



# DESIGNS



Note: Some designs in this collection may have been created using unique special stitches and/or techniques. To preserve design integrity when rescaling or rotating designs in your software, always rescale or rotate designs using the handles directly on-screen.

## FABRIC REQUIRED

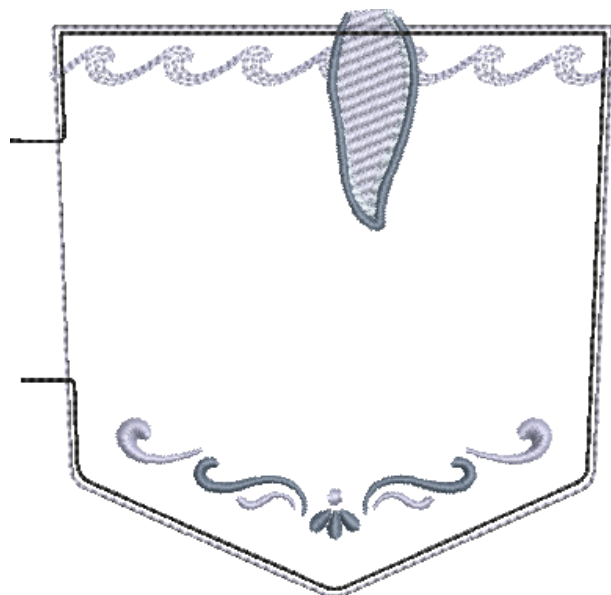

### 51240-13 Stitch 'N' Turn Whale Pocket Large

Size Inches:                      Size mm:                      Stitch Count:  
**4.37 X 4.51 in.**                      **111.0 X 114.6 mm**                      **3589 St.**

- 1. Fabric Placement Stitch .....0020
- 2. Fabric Tackdown .....3641
- 3. Medium Blue Detail .....3641
- 4. Light Blue Detail.....3963
- 5. Dark Blue Detail ..... 3743
- 6. Seam Stitch Match Fabric .....0020

### 51240-14 Whale Pocket Placement

Size Inches:                      Size mm:                      Stitch Count:  
**7.39 X 4.83 in.**                      **187.7 X 122.7 mm**                      **7628 St.**

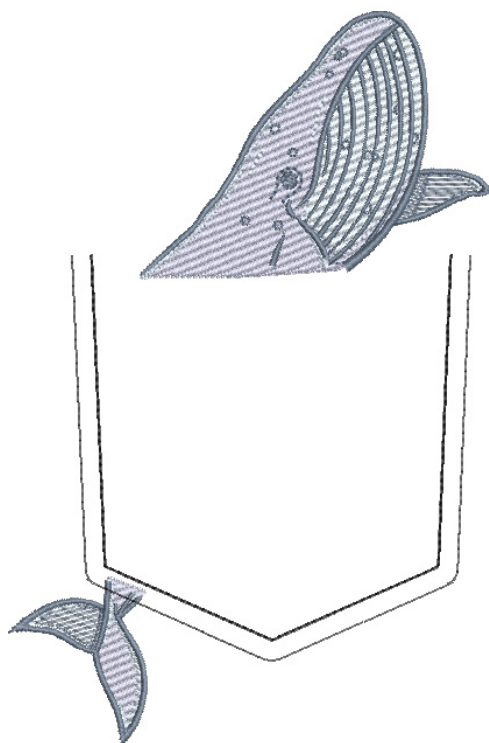

- 1. Medium Blue Detail .....3641
- 2. Light Blue Detail.....3963
- 3. Dark Blue Detail ..... 3743
- 4. Pocket Placement Stitch Match Fabric.0020
- 5. Pocket Tackdown Match Fabric.....0020

# DESIGNS



Note: Some designs in this collection may have been created using unique special stitches and/or techniques. To preserve design integrity when rescaling or rotating designs in your software, always rescale or rotate designs using the handles directly on-screen.

## FABRIC REQUIRED

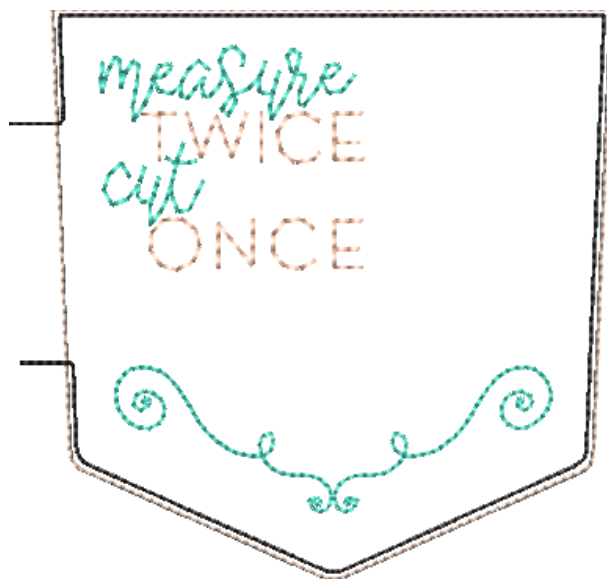

### 51240-15 Stitch 'N' Turn Sewing Notion Pocket Large

Size Inches:                      Size mm:                      Stitch Count:  
**4.23 X 4.49 in.      107.4 X 114.0 mm      2653 St.**

- 1. Fabric Placement Stitch .....2520
- 2. Fabric Tackdown .....2520
- 3. Pink Lettering .....2520
- 4. Blue Lettering and Detail..... 4620
- 5. Seam Stitch Match Fabric .....0020

### 51240-16 Sewing Notion Pocket Placement Large

Size Inches:                      Size mm:                      Stitch Count:  
**7.65 X 4.41 in.      194.3 X 112.0 mm      5676 St.**

- 1. Green Detail ..... 4620
- 2. White Detail..... 0010
- 3. Pocket Placement Stitch Match Fabric.0020
- 4. Pocket Tackdown Match Fabric.....0020

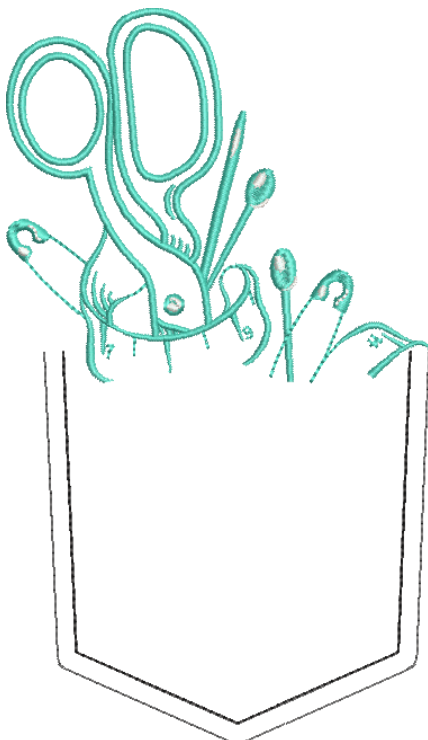

# DESIGNS



Note: Some designs in this collection may have been created using unique special stitches and/or techniques. To preserve design integrity when rescaling or rotating designs in your software, always rescale or rotate designs using the handles directly on-screen.

## FABRIC REQUIRED

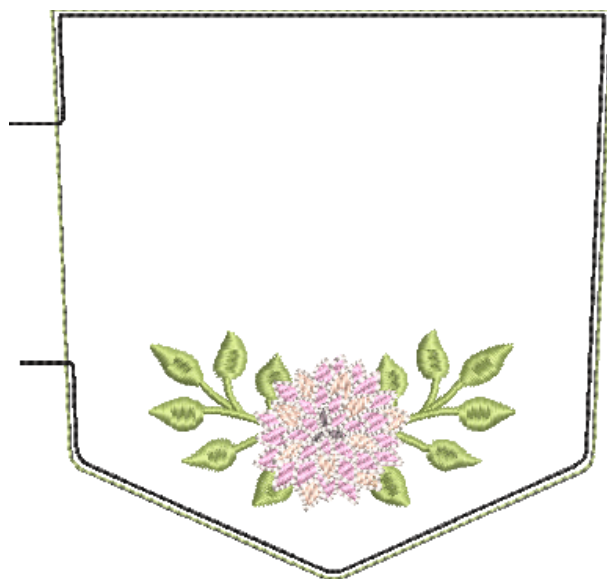

### 51240-17 Stitch 'N' Turn Floral Pocket Large

Size Inches:                      Size mm:                      Stitch Count:  
**4.23 X 4.49 in.**            **107.4 X 114.0 mm**            **4668 St.**

- 1. Fabric Placement Stitch .....5832
- 2. Fabric Tackdown .....5832
- 3. Green Detail .....5832
- 4. Light Pink Detail ..... 2550
- 5. Dark Pink Detail.....2520
- 6. Gray Detail ..... 0132
- 7. White Detail..... 0010
- 8. Seam Stitch Match Fabric ..... 0020

### 51240-18 Floral Pocket Placement Large

Size Inches:                      Size mm:                      Stitch Count:  
**5.46 X 4.61 in.**            **138.7 X 117.1 mm**            **4033 St.**

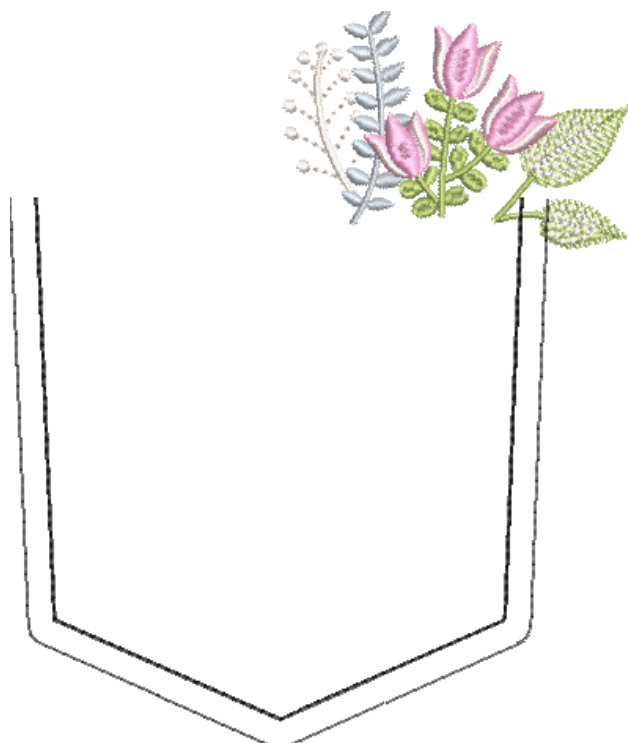

- 1. White Stem ..... 0010
- 2. Blue Stem.....3750
- 3. Green Leaves ..... 5832
- 4. Pink Flowers..... 2550
- 5. White Highlights..... 0010
- 6. Pocket Placement Stitch Match Fabric. 0020
- 7. Pocket Tackdown Match Fabric..... 0020



# DESIGNS



Note: Some designs in this collection may have been created using unique special stitches and/or techniques. To preserve design integrity when rescaling or rotating designs in your software, always rescale or rotate designs using the handles directly on-screen.

## FABRIC REQUIRED

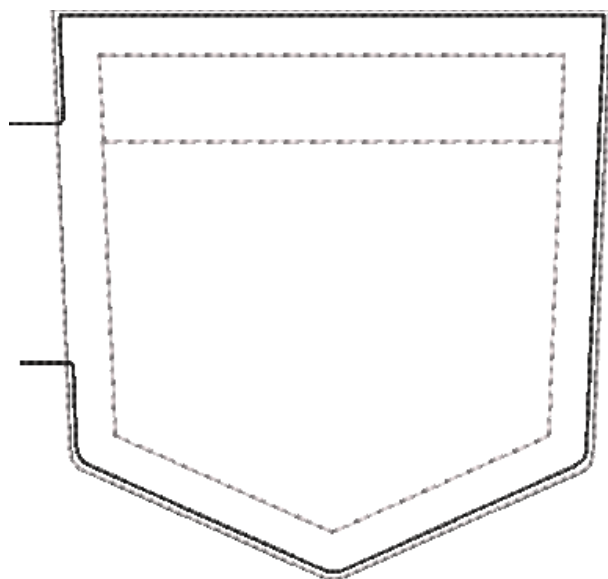

### 51240-19 Stitch 'N' Turn Nerdy Pocket Large

Size Inches:                      Size mm:                      Stitch Count:  
**4.23 X 4.49 in.**            **107.4 X 114.0 mm**            **1620 St.**

- 1. Fabric Placement Stitch..... 0131
- 2. Fabric Tackdown ..... 0131
- 3. Gray Linework..... 0131
- 4. Seam Stitch Match Fabric ..... 0020

### 51240-20 Nerdy Pocket Placement Large

Size Inches:                      Size mm:                      Stitch Count:  
**6.40 X 5.02 in.**            **162.6 X 127.5 mm**            **6813 St.**

- 1. Light Blue Detail.....3963
- 2. White Detail..... 0010
- 3. Dark Gray Detail..... 0132
- 4. Light Gray Detail..... 0131
- 5. Black Detail ..... 0020
- 6. Red Detail ..... 1725
- 7. Tan Detail ..... 0934
- 8. Dark Blue Detail ..... 3743
- 9. Pocket Placement Stitch Match Fabric. 0020
- 10. Pocket Tackdown Match Fabric..... 0020



# DESIGNS



Note: Some designs in this collection may have been created using unique special stitches and/or techniques. To preserve design integrity when rescaling or rotating designs in your software, always rescale or rotate designs using the handles directly on-screen.

## FABRIC REQUIRED

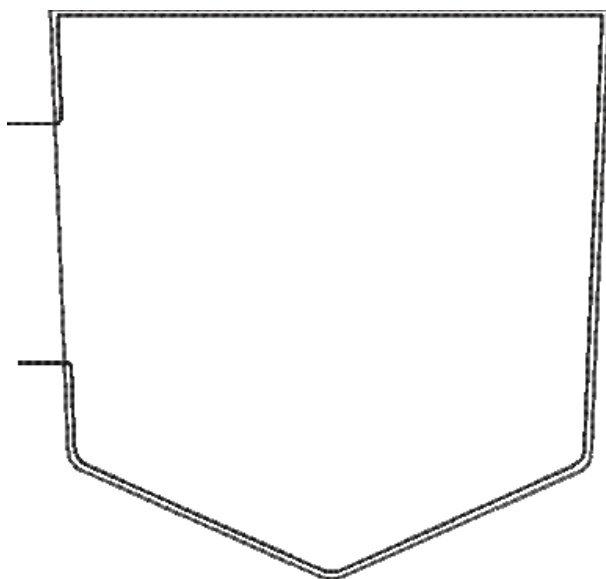

### 51240-21 Stitch 'N' Turn Blank Pocket Large

Size Inches:                      Size mm:                      Stitch Count:  
**4.23 X 4.49 in.      107.4 X 114.0 mm      1074 St.**

- 1. Fabric Placement Stitch .....0020
- 2. Fabric Tackdown .....0020
- 3. Seam Stitch Match Fabric .....0020

### 51240-22 Blank Pocket Placement Large

Size Inches:                      Size mm:                      Stitch Count:  
**4.08 X 4.00 in.      103.6 X 101.6 mm      564 St.**

- 1. Pocket Placement Stitch Match Fabric.0020
- 2. Pocket Tackdown Match Fabric.....0020

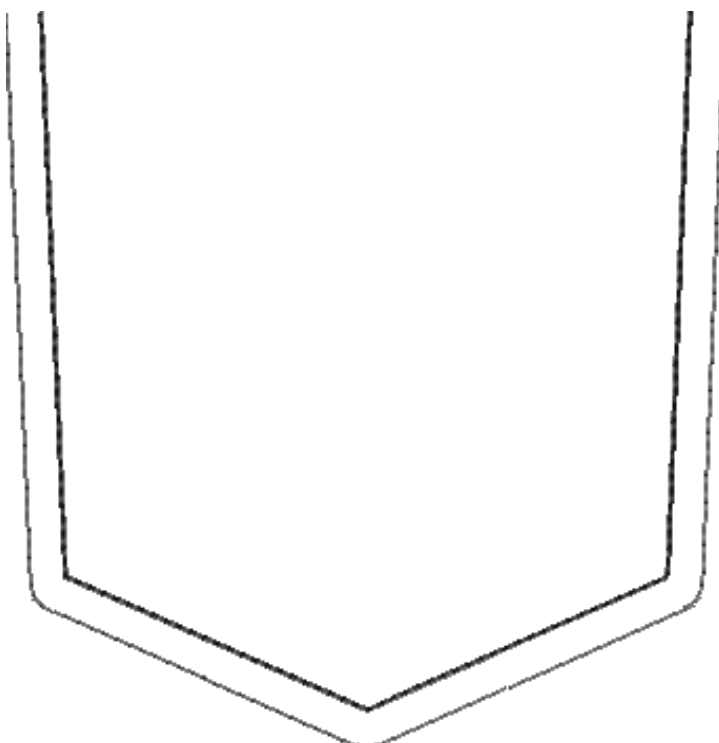

# DESIGNS



Note: Some designs in this collection may have been created using unique special stitches and/or techniques. To preserve design integrity when rescaling or rotating designs in your software, always rescale or rotate designs using the handles directly on-screen.

## FABRIC REQUIRED



### 51240-23 Stitch 'N' Turn UFO Pocket Small

Size Inches: **3.42 X 3.37 in.**      Size mm: **86.9 X 85.6 mm**      Stitch Count: **5898 St.**

- 1. Fabric Placement Stitch ..... 0020
- 2. Fabric Tackdown ..... 0020
- 3. Trees ..... 0020
- 4. Beam ..... 3963
- 5. White Spots ..... 0010
- 6. Cow ..... 0020
- 7. Beam Outline ..... 0010
- 8. Stars ..... 0504
- 9. Seam Stitch Match Fabric ..... 0020

### 51240-24 UFO Pocket Placement Small

Size Inches: **5.24 X 3.00 in.**      Size mm: **133.1 X 76.2 mm**      Stitch Count: **4186 St.**

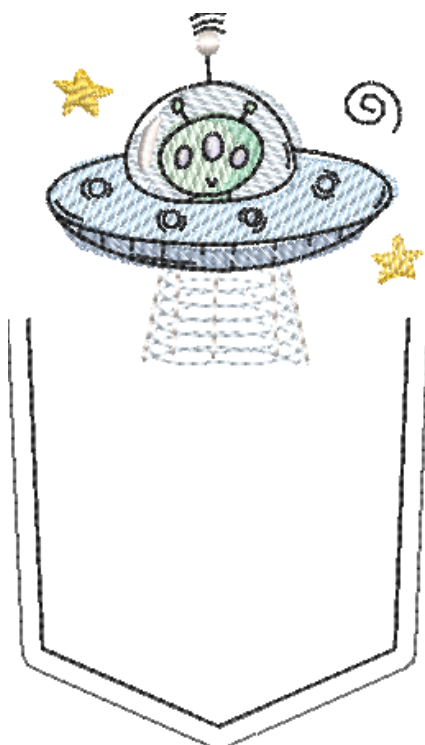

- 1. Beam ..... 3963
- 2. Beam Outlines ..... 0010
- 3. Dark Blue Ship Detail ..... 3810
- 4. Medium Blue Ship Detail ..... 3910
- 5. Light Blue Ship Detail ..... 3963
- 6. Light Green Alien Shading ..... 5450
- 7. Dark Green Alien Shading ..... 5230
- 8. Purple Eyes ..... 3151
- 9. Black Ship Outlines ..... 0020
- 10. White Highlights ..... 0010
- 11. Stars ..... 0504
- 12. Pocket Placement Stitch Match Fabric. 0020
- 13. Pocket Tackdown Match Fabric ..... 0020



# DESIGNS



Note: Some designs in this collection may have been created using unique special stitches and/or techniques. To preserve design integrity when rescaling or rotating designs in your software, always rescale or rotate designs using the handles directly on-screen.

## FABRIC REQUIRED

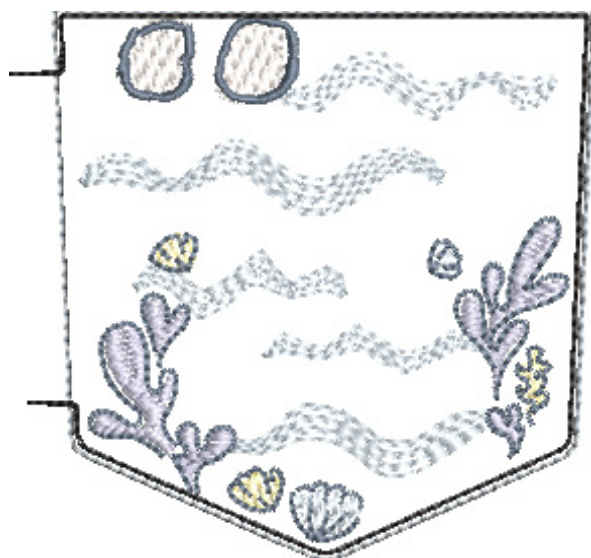

### 51240-25 Stitch 'N' Turn MerCat Pocket Small

Size Inches:                      Size mm:                      Stitch Count:  
**3.18 X 3.38 in.**                      **80.8 X 85.9 mm**                      **4352 St.**

- 1. Fabric Placement Stitch .....3963
- 2. Fabric Tackdown .....3963
- 3. Blue Waves and Shells .....3963
- 4. Purple Coral.....3151
- 5. Yellow Shells .....0630
- 6. Paws ..... 0010
- 7. Design Outlines ..... 3743
- 8. Seam Stitch Match Fabric .....0020

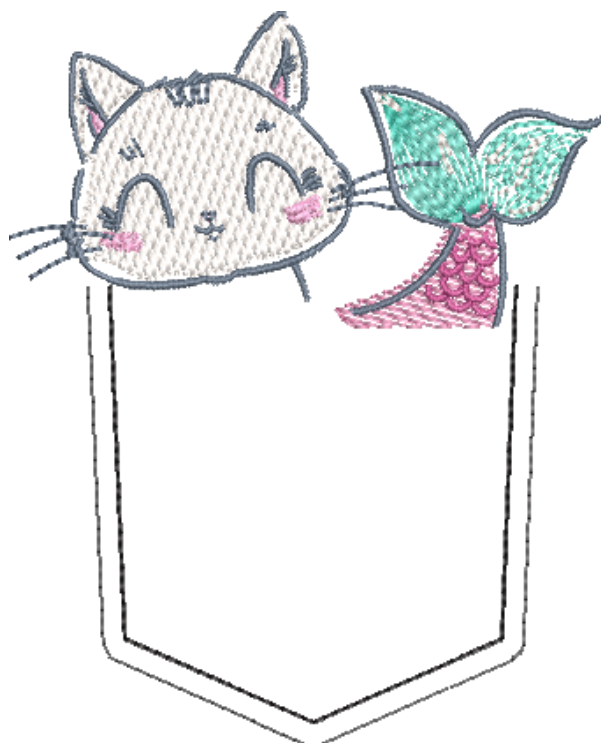

### 51240-26 MerCat Pocket Placement Small

Size Inches:                      Size mm:                      Stitch Count:  
**4.89 X 3.95 in.**                      **124.2 X 100.3 mm**                      **5567 St.**

- 1. Medium Pink Tail Detail..... 2532
- 2. Dark Pink Tail Detail..... 2508
- 3. Blue Tail Detail ..... 4620
- 4. White Head and Tail Detail..... 0010
- 5. Light Pink Ears and Cheeks..... 2550
- 6. Design Outlines ..... 3743
- 7. Pocket Placement Stitch Match Fabric.0020
- 8. Pocket Tackdown Match Fabric.....0020

# DESIGNS



Note: Some designs in this collection may have been created using unique special stitches and/or techniques. To preserve design integrity when rescaling or rotating designs in your software, always rescale or rotate designs using the handles directly on-screen.

## FABRIC REQUIRED

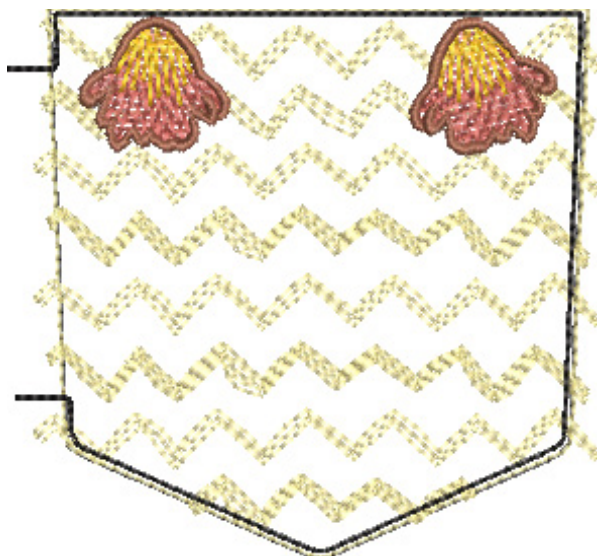

### 51240-27 Stitch 'N' Turn Monster Pocket Small

Size Inches: **3.18 X 3.42 in.**      Size mm: **80.8 X 86.9 mm**      Stitch Count: **4344 St.**

- 1. Fabric Placement Stitch.....0630
- 2. Fabric Tackdown .....0630
- 3. Yellow Zig Zags.....0630
- 4. Dark Orange Fur Shading.....1332
- 5. Light Orange Fur Shading.....0811
- 6. Brown Outlines.....1322
- 7. Seam Stitch Match Fabric.....0020

### 51240-28 Monster Pocket Placement Small

Size Inches: **5.10 X 3.00 in.**      Size mm: **129.5 X 76.2 mm**      Stitch Count: **6109 St.**

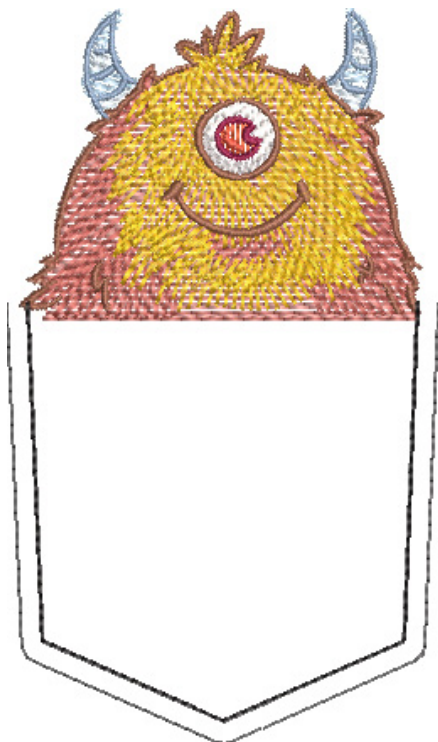

- 1. Dark Orange Fur Shading.....1332
- 2. Light Orange Fur Shading.....0811
- 3. Light Blue Horn Shading.....3963
- 4. Medium Blue Horn Shading.....3910
- 5. Dark Blue Horn Shading.....3810
- 6. White Eye Shading.....0010
- 7. Gray Eye Shading.....0131
- 8. Medium Red Eye Shading.....1913
- 9. Light Red Eye Shading.....1521
- 10. Dark Red Eye Shading.....2123
- 11. Brown Outlines.....1322
- 12. Pocket Placement Stitch Match Fabric.....0020
- 13. Pocket Tackdown Match Fabric.....0020

# DESIGNS



Note: Some designs in this collection may have been created using unique special stitches and/or techniques. To preserve design integrity when rescaling or rotating designs in your software, always rescale or rotate designs using the handles directly on-screen.

## FABRIC REQUIRED

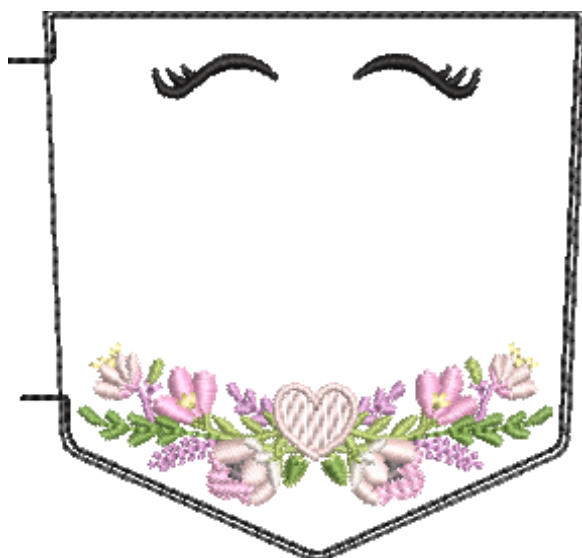

### 51240-29 Stitch 'N' Turn Unicorn Pocket Small

Size Inches: **3.18 X 3.34 in.**      Size mm: **80.8 X 84.8 mm**      Stitch Count: **4457 St.**

- 1. Fabric Placement Stitch ..... 0020
- 2. Fabric Tackdown ..... 0020
- 3. Eyes ..... 0020
- 4. Purple Detail ..... 2830
- 5. Light Green Detail ..... 5832
- 6. Dark Pink Detail ..... 2550
- 7. Light Pink Detail ..... 2160
- 8. White Detail ..... 0010
- 9. Dark Green Detail ..... 5633
- 10. Gray Detail ..... 0132
- 11. Yellow Detail ..... 0630
- 12. Seam Stitch Match Fabric ..... 0020

### 51240-30 Unicorn Pocket Placement Small

Size Inches: **5.15 X 3.00 in.**      Size mm: **130.8 X 76.2 mm**      Stitch Count: **2472 St.**



- 1. Dark Pink Horn Detail ..... 2550
- 2. Orange Horn Detail ..... 0811
- 3. Yellow Horn Detail ..... 0630
- 4. Blue Horn Detail ..... 3910
- 5. Light Purple Horn Detail ..... 2830
- 6. Dark Purple Horn Detail ..... 2920
- 7. Blue Flower and Heart ..... 3910
- 8. Pink Heart ..... 2160
- 9. Orange Flower ..... 0811
- 10. Yellow Stars and Flower ..... 0630
- 11. Green Leaves and Flower Detail ..... 5832
- 12. Gray Stamens ..... 0132
- 13. Ears ..... 2160
- 14. Pocket Placement Stitch Match Fabric. 0020
- 15. Pocket Tackdown Match Fabric ..... 0020



# DESIGNS



Note: Some designs in this collection may have been created using unique special stitches and/or techniques. To preserve design integrity when rescaling or rotating designs in your software, always rescale or rotate designs using the handles directly on-screen.

## FABRIC REQUIRED

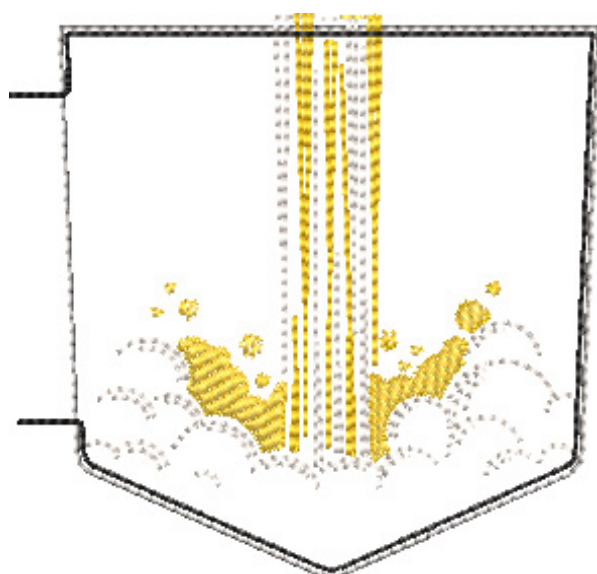

### 51240-31 Stitch 'N' Turn Rocket Pocket Small

Size Inches:                      Size mm:                      Stitch Count:  
**3.26 X 3.42 in.**                      **82.8 X 86.9 mm**                      **3498 St.**

- 1. Fabric Placement Stitch ..... 0010
- 2. Fabric Tackdown ..... 0010
- 3. White Detail ..... 0010
- 4. Orange Detail ..... 0811
- 5. Seam Stitch Match Fabric ..... 0020

### 51240-32 Rocket Pocket Placement Small

Size Inches:                      Size mm:                      Stitch Count:  
**5.57 X 3.00 in.**                      **141.5 X 76.2 mm**                      **3905 St.**

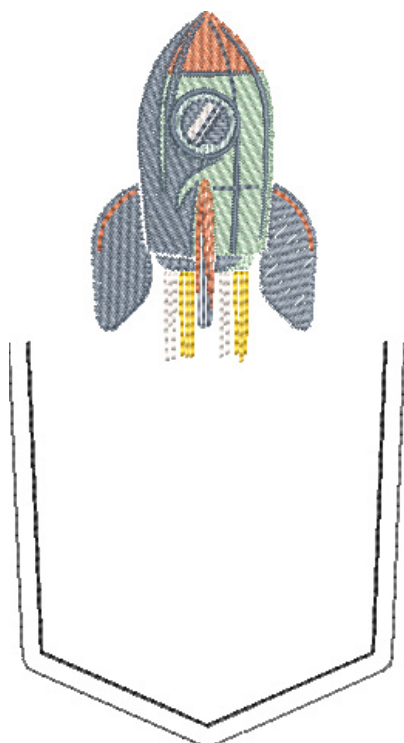

- 1. White Smoke ..... 0010
- 2. Orange Smoke ..... 0811
- 3. Light Green Rocket Detail ..... 5450
- 4. Dark Green Rocket Detail ..... 4752
- 5. Red Rocket Nose ..... 1725
- 6. White Window Detail ..... 0010
- 7. Blue Rocket Detail ..... 3743
- 8. Red Fin Detail ..... 1725
- 9. Pocket Placement Stitch Match Fabric. 0020
- 10. Pocket Tackdown Match Fabric ..... 0020

# DESIGNS



Note: Some designs in this collection may have been created using unique special stitches and/or techniques. To preserve design integrity when rescaling or rotating designs in your software, always rescale or rotate designs using the handles directly on-screen.

## FABRIC REQUIRED

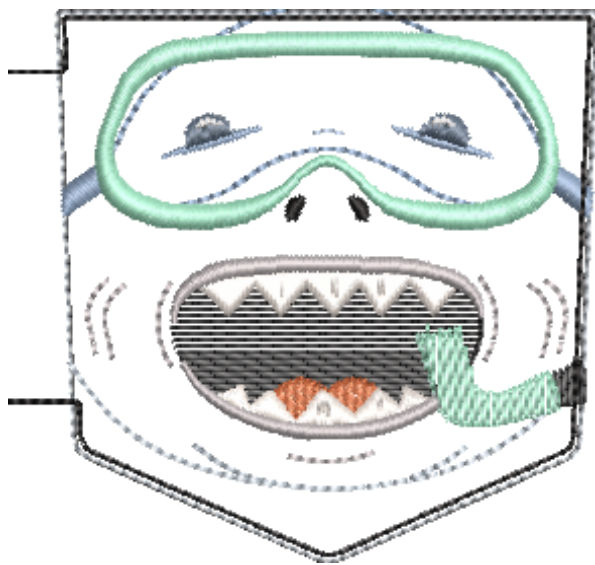

### 51240-33 Stitch 'N' Turn Shark Pocket Small

Size Inches: **3.20 X 3.41 in.**      Size mm: **81.3 X 86.6 mm**      Stitch Count: **5114 St.**

- 1. Fabric Placement Stitch .....3750
- 2. Fabric Tackdown .....3750
- 3. Light Blue Detail.....3750
- 4. Medium Blue Detail ..... 3810
- 5. Dark Blue Detail ..... 3743
- 6. Black Detail ..... 0020
- 7. Red Detail ..... 1725
- 8. Green Detail ..... 5230
- 9. White Detail..... 0010
- 10. Gray Detail ..... 0131
- 11. Seam Stitch Match Fabric ..... 0020

### 51240-34 Shark Pocket Placement Small

Size Inches: **4.69 X 4.06 in.**      Size mm: **119.1 X 103.1 mm**      Stitch Count: **1835 St.**

- 1. Light Blue Detail.....3750
- 2. Medium Blue Detail ..... 3810
- 3. Black Detail ..... 0020
- 4. Green Detail ..... 5230
- 5. Pocket Placement Stitch Match Fabric. 0020
- 6. Pocket Tackdown Match Fabric ..... 0020

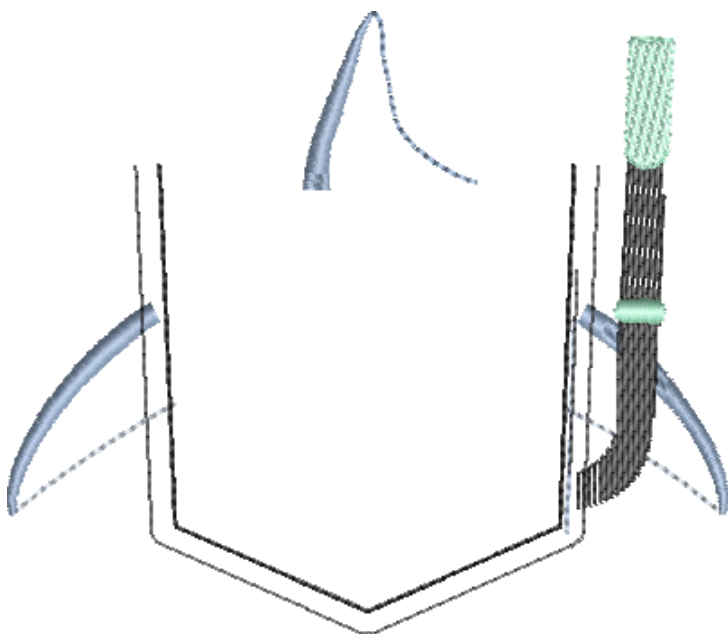

# DESIGNS



Note: Some designs in this collection may have been created using unique special stitches and/or techniques. To preserve design integrity when rescaling or rotating designs in your software, always rescale or rotate designs using the handles directly on-screen.

## FABRIC REQUIRED

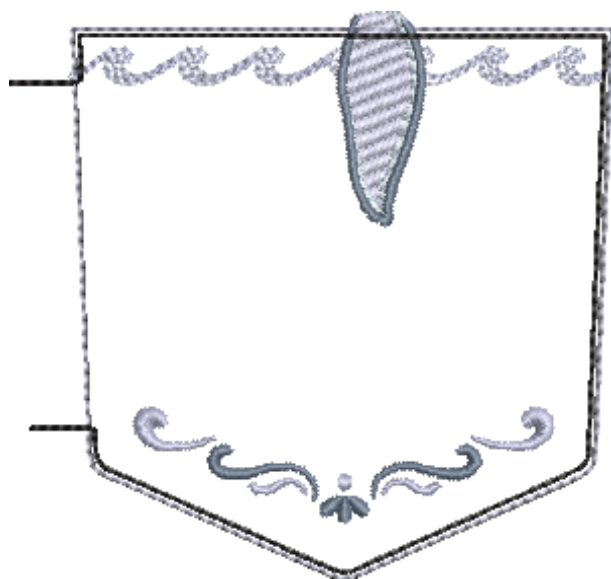

### 51240-35 Stitch 'N' Turn Whale Pocket Small

Size Inches: **3.28 X 3.51 in.**      Size mm: **83.3 X 89.2 mm**      Stitch Count: **2719 St.**

- 1. Fabric Placement Stitch .....0020
- 2. Fabric Tackdown .....3641
- 3. Medium Blue Detail .....3641
- 4. Light Blue Detail.....3963
- 5. Dark Blue Detail ..... 3743
- 6. Seam Stitch Match Fabric .....0020

### 51240-36 Whale Pocket Placement Small

Size Inches: **5.55 X 3.62 in.**      Size mm: **141.0 X 91.9 mm**      Stitch Count: **5461 St.**

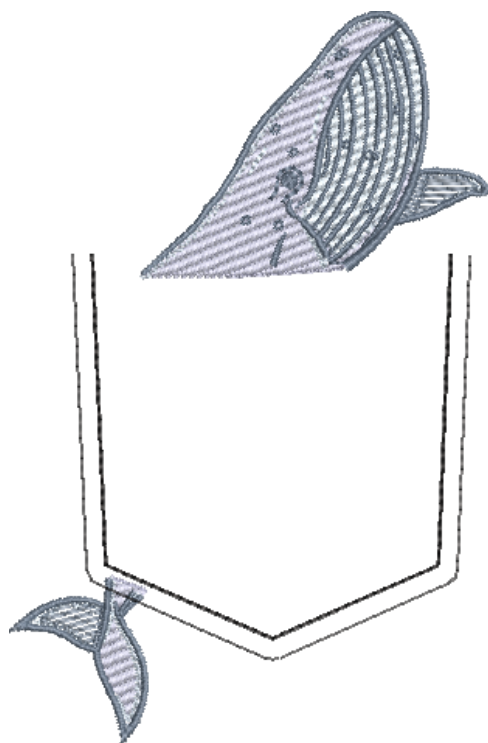

- 1. Medium Blue Detail .....3641
- 2. Light Blue Detail.....3963
- 3. Dark Blue Detail ..... 3743
- 4. Pocket Placement Stitch Match Fabric.0020
- 5. Pocket Tackdown Match Fabric.....0020

# DESIGNS



Note: Some designs in this collection may have been created using unique special stitches and/or techniques. To preserve design integrity when rescaling or rotating designs in your software, always rescale or rotate designs using the handles directly on-screen.

## FABRIC REQUIRED

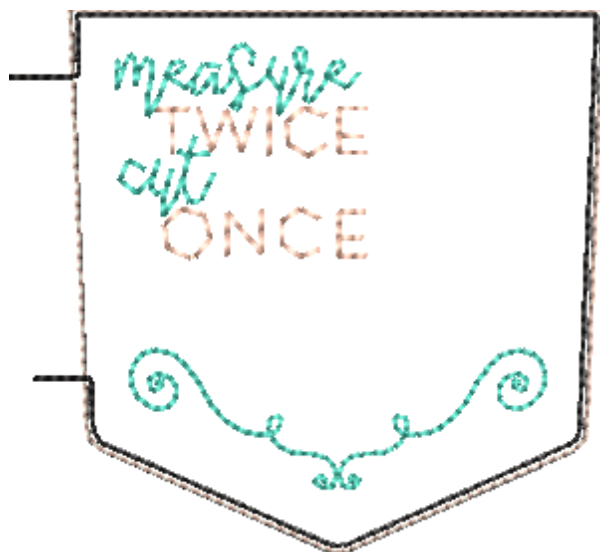

### 51240-37 Stitch 'N' Turn Sewing Notion Pocket Small

Size Inches:                      Size mm:                      Stitch Count:  
**3.18 X 3.48 in.**                      **80.8 X 88.4 mm**                      **2129 St.**

- 1. Fabric Placement Stitch .....2520
- 2. Fabric Tackdown .....2520
- 3. Pink Lettering .....2520
- 4. Blue Lettering and Detail..... 4620
- 5. Seam Stitch Match Fabric .....0020

### 51240-38 Sewing Notion Pocket Placement Small

Size Inches:                      Size mm:                      Stitch Count:  
**5.74 X 3.31 in.**                      **145.8 X 84.1 mm**                      **4310 St.**

- 1. Green Detail ..... 4620
- 2. White Detail..... 0010
- 3. Pocket Placement Stitch Match Fabric.0020
- 4. Pocket Tackdown Match Fabric.....0020

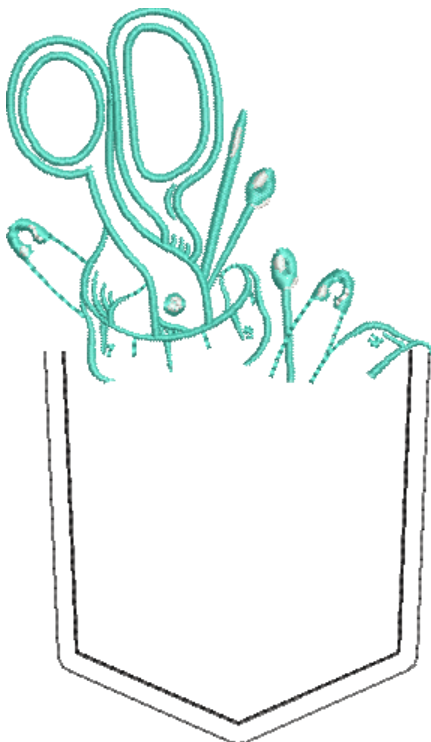



# DESIGNS



Note: Some designs in this collection may have been created using unique special stitches and/or techniques. To preserve design integrity when rescaling or rotating designs in your software, always rescale or rotate designs using the handles directly on-screen.

## FABRIC REQUIRED

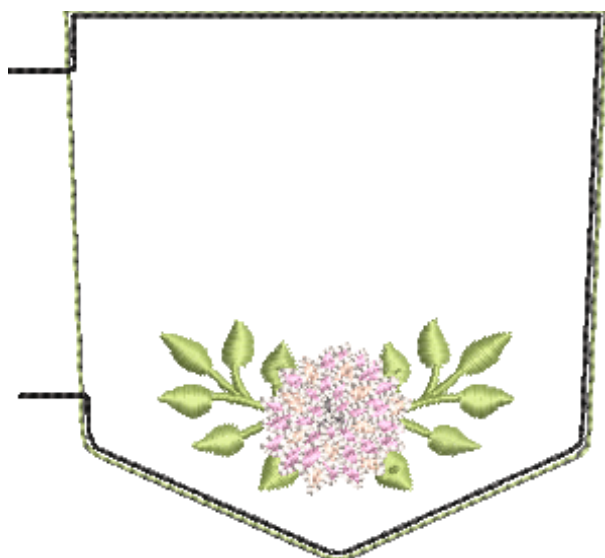

### 51240-39 Stitch 'N' Turn Floral Pocket Small

Size Inches:                      Size mm:                      Stitch Count:  
**3.18 X 3.46 in.**                      **80.8 X 87.9 mm**                      **3530 St.**

- 1. Fabric Placement Stitch .....5832
- 2. Fabric Tackdown .....5832
- 3. Green Detail .....5832
- 4. Light Pink Detail ..... 2550
- 5. Dark Pink Detail.....2520
- 6. Gray Detail ..... 0132
- 7. White Detail..... 0010
- 8. Seam Stitch Match Fabric ..... 0020

### 51240-40 Floral Pocket Placement Small

Size Inches:                      Size mm:                      Stitch Count:  
**4.10 X 3.45 in.**                      **104.1 X 87.6 mm**                      **2960 St.**

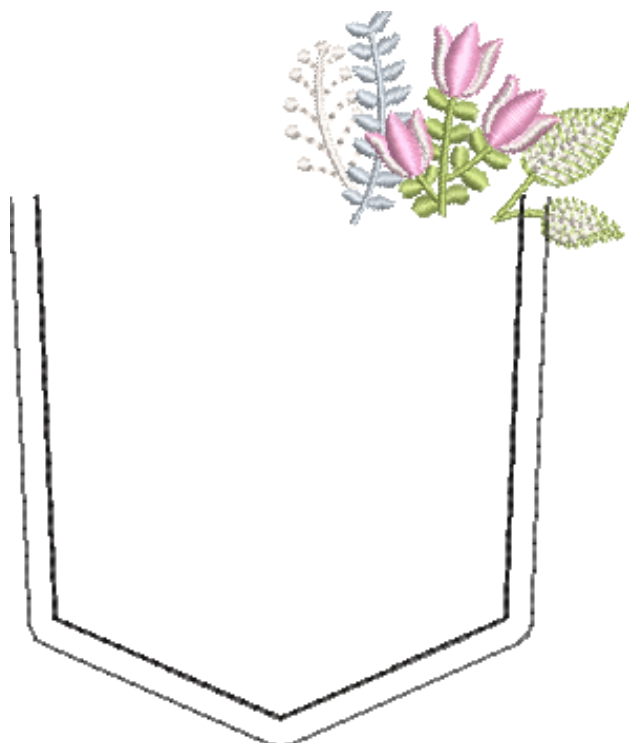

- 1. White Stem ..... 0010
- 2. Blue Stem.....3750
- 3. Green Leaves .....5832
- 4. Pink Flowers..... 2550
- 5. White Highlights..... 0010
- 6. Pocket Placement Stitch Match Fabric. 0020
- 7. Pocket Tackdown Match Fabric..... 0020

# DESIGNS



Note: Some designs in this collection may have been created using unique special stitches and/or techniques. To preserve design integrity when rescaling or rotating designs in your software, always rescale or rotate designs using the handles directly on-screen.

## FABRIC REQUIRED

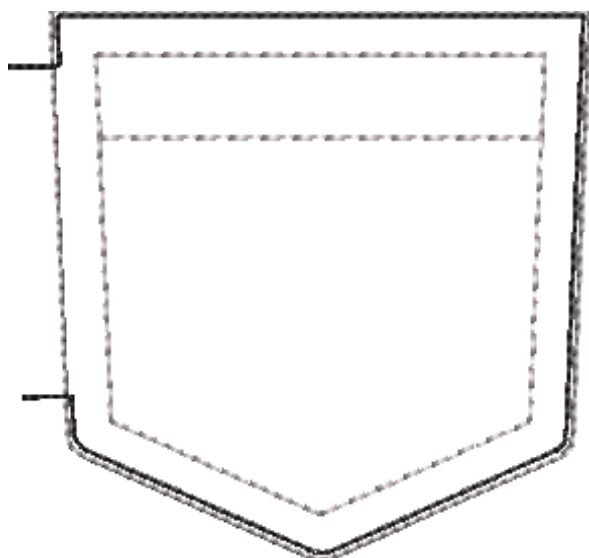

### 51240-41 Stitch 'N' Turn Nerdy Pocket Small

Size Inches: **3.18 X 3.37 in.**      Size mm: **80.8 X 85.6 mm**      Stitch Count: **1244 St.**

- 1. Fabric Placement Stitch ..... 0131
- 2. Fabric Tackdown ..... 0131
- 3. Gray Linework..... 0131
- 4. Seam Stitch Match Fabric ..... 0020

### 51240-42 Nerdy Pocket Placement Small

Size Inches: **4.80 X 3.76 in.**      Size mm: **121.9 X 95.5 mm**      Stitch Count: **4749 St.**



- 1. Light Blue Detail.....3963
- 2. White Detail..... 0010
- 3. Dark Gray Detail..... 0132
- 4. Light Gray Detail..... 0131
- 5. Black Detail ..... 0020
- 6. Red Detail ..... 1725
- 7. Tan Detail ..... 0934
- 8. Dark Blue Detail ..... 3743
- 9. Pocket Placement Stitch Match Fabric. 0020
- 10. Pocket Tackdown Match Fabric..... 0020

# DESIGNS



Note: Some designs in this collection may have been created using unique special stitches and/or techniques. To preserve design integrity when rescaling or rotating designs in your software, always rescale or rotate designs using the handles directly on-screen.

## FABRIC REQUIRED

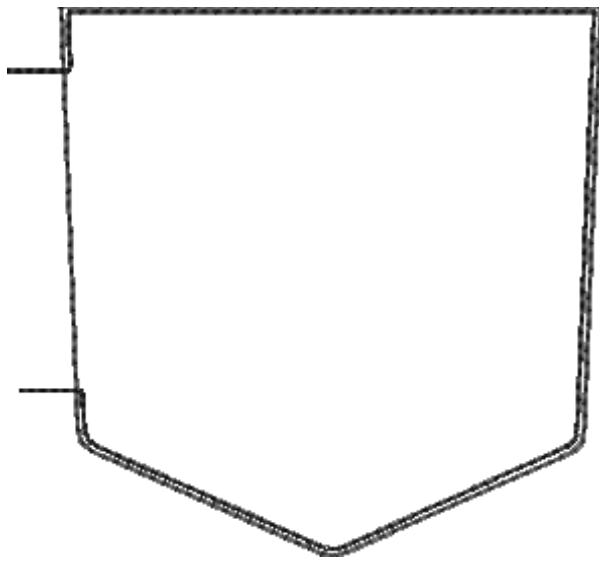

### 51240-43 Stitch 'N' Turn Blank Pocket Small

Size Inches:                      Size mm:                      Stitch Count:  
**3.18 X 3.44 in.**                      **80.8 X 87.4 mm**                      **833 St.**

- 1. Fabric Placement Stitch ..... 0020
- 2. Fabric Tackdown ..... 0020
- 3. Seam Stitch Match Fabric ..... 0020

### 51240-44 Blank Pocket Placement Small

Size Inches:                      Size mm:                      Stitch Count:  
**3.06 X 3.00 in.**                      **77.7 X 76.2 mm**                      **430 St.**

- 1. Pocket Placement Stitch Match Fabric. 0020
- 2. Pocket Tackdown Match Fabric ..... 0020

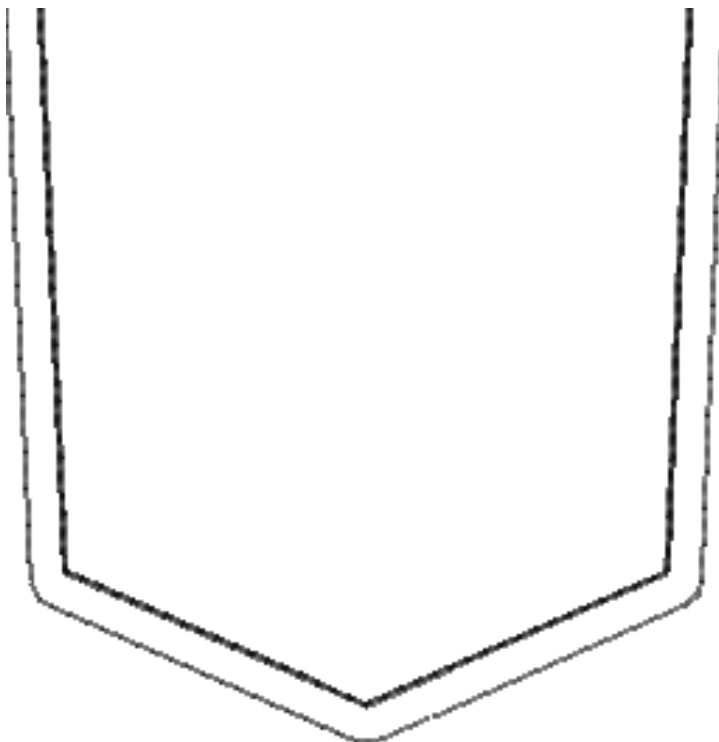

# MATERIALS



## Stabilizer

- Fusible Woven
- Fusible PolyMesh CutAway
- StabilStick Template Sheets
- StitcH2O WashAway

## Fabric/Notions

- Gentle Touch Backing
- Expert Point and Press Tool
- Expert Embroidery Press Cloth
- Large Pockets - (2) 6" x 6" fabric
- Small Pockets - (2) 5" x 5" fabric
- Child's T-shirt
- Expert Embroidery Tape TearAway



# INSTRUCTIONS



## Step 1

- **Note:** Designs used for this project are 51240-09 and 51240-10. The other designs are stitched in the same manner. Always stitch the pocket design first.
- Fuse a piece of Fusible Woven to the wrong side of the front pocket piece. This gives the pocket fabric more body to help keep it from puckering during embroidery.



## Step 2

- Cut 1 piece of Fusible PolyMesh larger than the hoop. Hoop the stabilizer with the fusible side down. Load pocket design 51240-09 onto your machine.
- **Note:** When the pocket is turned and pressed, the fusible will adhere to the pocket lining.

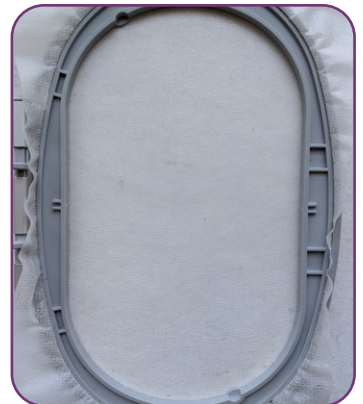

## Step 3

- Stitch Color 1, Fabric Placement Stitch.

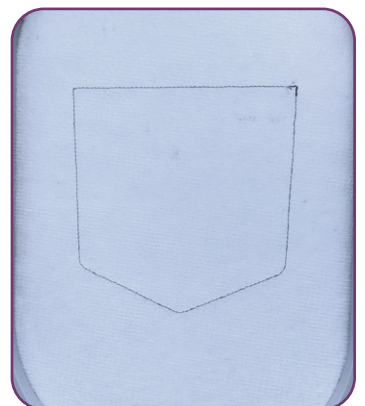

# INSTRUCTIONS



## Step 4

- Place prepped fabric right side up, over the placement stitch, covering entirely.
- Tape in place.

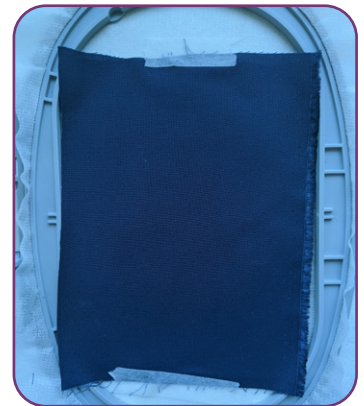

## Step 5

- Stitch Color 2, Fabric Tackdown.



## Step 6

- Follow thread chart, stop before stitching the final Color 5, the Seam stitch, matching your thread to the pocket fabric.



# INSTRUCTIONS



## Step 7

- Place the pocket lining, right side down, over the stitched pocket, covering entirely.
- Tape in place.



## Step 8

- Stitch Color 5, the Seam stitch, matching your thread to the pocket fabric.



## Step 9

- Remove pocket from the hoop and trim to a 1/4" seam allowance. Clip corners.



# INSTRUCTIONS



## Step 10

- Turn pocket right side out, using the Point and Press Tool to push out the corners.



## Step 11

- Press face down into a Perfect Embroidery Press Cloth. Set pocket aside.



## Step 12

- Print centerpoint template onto a StabilStick Template sheet of 51240-10 (found on page 50) to use for placement on the t-shirt.
- **Note:** to ensure proper placement, print the design template at 100% scale.
- Trim around template.

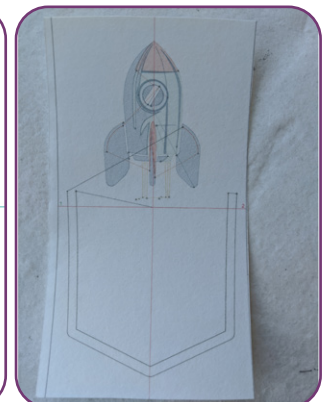
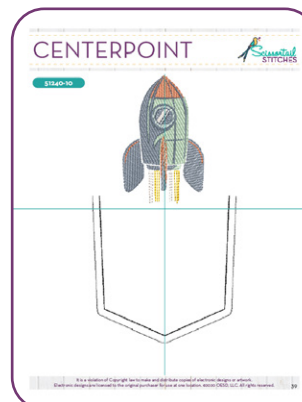



# INSTRUCTIONS



## Step 13

- Mark a vertical line on the shirt where the design will be centered.



## Step 14

- Turn the shirt inside out. Iron one piece of Fusible PolyMesh to the wrong side of the front-shirt where the pocket will be placed.



## Step 15

- Peel the paper from the back of the template and place the template on the shirt, lining up the vertical line on the template with the vertical line on the shirt.



# INSTRUCTIONS



## Step 16

- Hoop the t-shirt. Use tape or hair clips to hold the excess fabric out of the design area.



## Step 17

- Move the hoop where the center of the design is under the needle. Rotate if necessary.
- **Tip!** Use available machine functions with the template to assure perfect placement of the design.



## Step 18

- Peel the template off the T-shirt.
- **Note:** The template is reusable, so you can put it back on the shiny side of the paper to keep it.

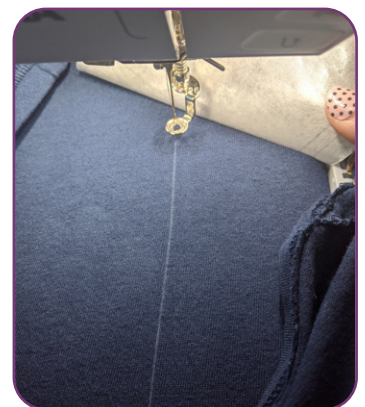

# INSTRUCTIONS



## Step 19

- Place a piece of StitchH2O topper over the design area. Tape in place.
- **Note:** The topper keeps the stitches from sinking into the fabric.



## Step 20

- Stitch the remaining colors for the design above the pocket, the rocket ship.
- Stitch the Pocket Placement Stitch Match Fabric.
- **Note:** The top thread for the placement stitch should match the fabric.



## Step 21

- Center the pocket within the placement stitch and tape in place.



# INSTRUCTIONS



## Step 22

- Stitch final Color, the Pocket Tackdown Match Fabric.



## Step 23

- Remove the shirt from the hoop. Remove tape and tear away excess topper. The rest will wash out. Turn the shirt inside out. Press the stabilizer with a warm iron. This will heat up the adhesive and make it easier to pull the stabilizer away from the fabric.



## Step 24

- Trim excess stabilizer to about a 1/4" away from the design.
- Be careful not to cut the T-shirt.



BACK OF PROJECT



# INSTRUCTIONS



## Step 25

- Cut a piece of Gentle Touch about an inch larger than the design. Round the edges and lay over the design with the fusible side against the fabric. Press with a warm iron.
- **Note:** The Gentle Touch covers the back of the embroidery to keep from irritating the skin.



BACK OF PROJECT

# CENTERPOINT



51240-02

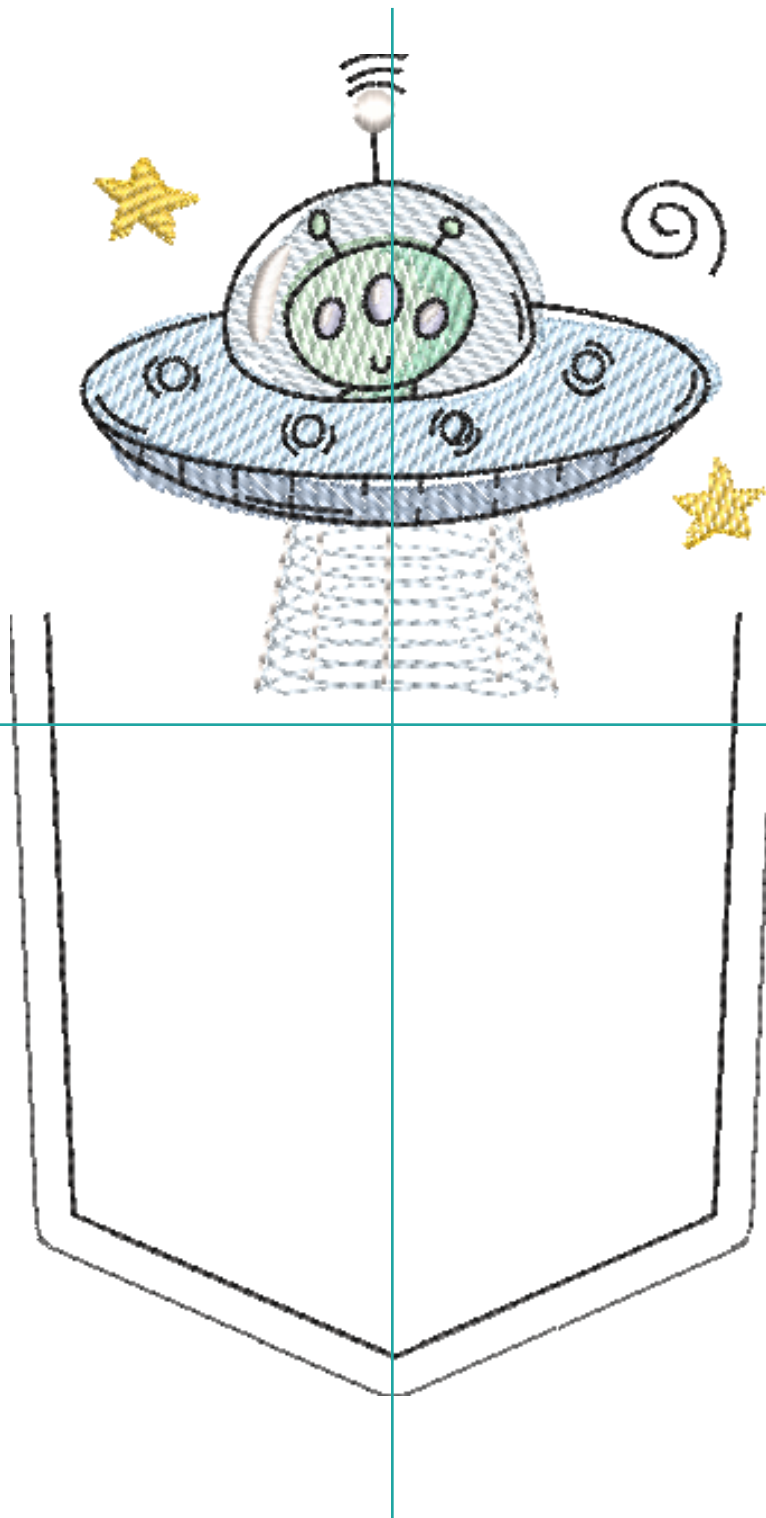

Note: to ensure proper placement, print the design template at 100% scale.

# CENTERPOINT



51240-04

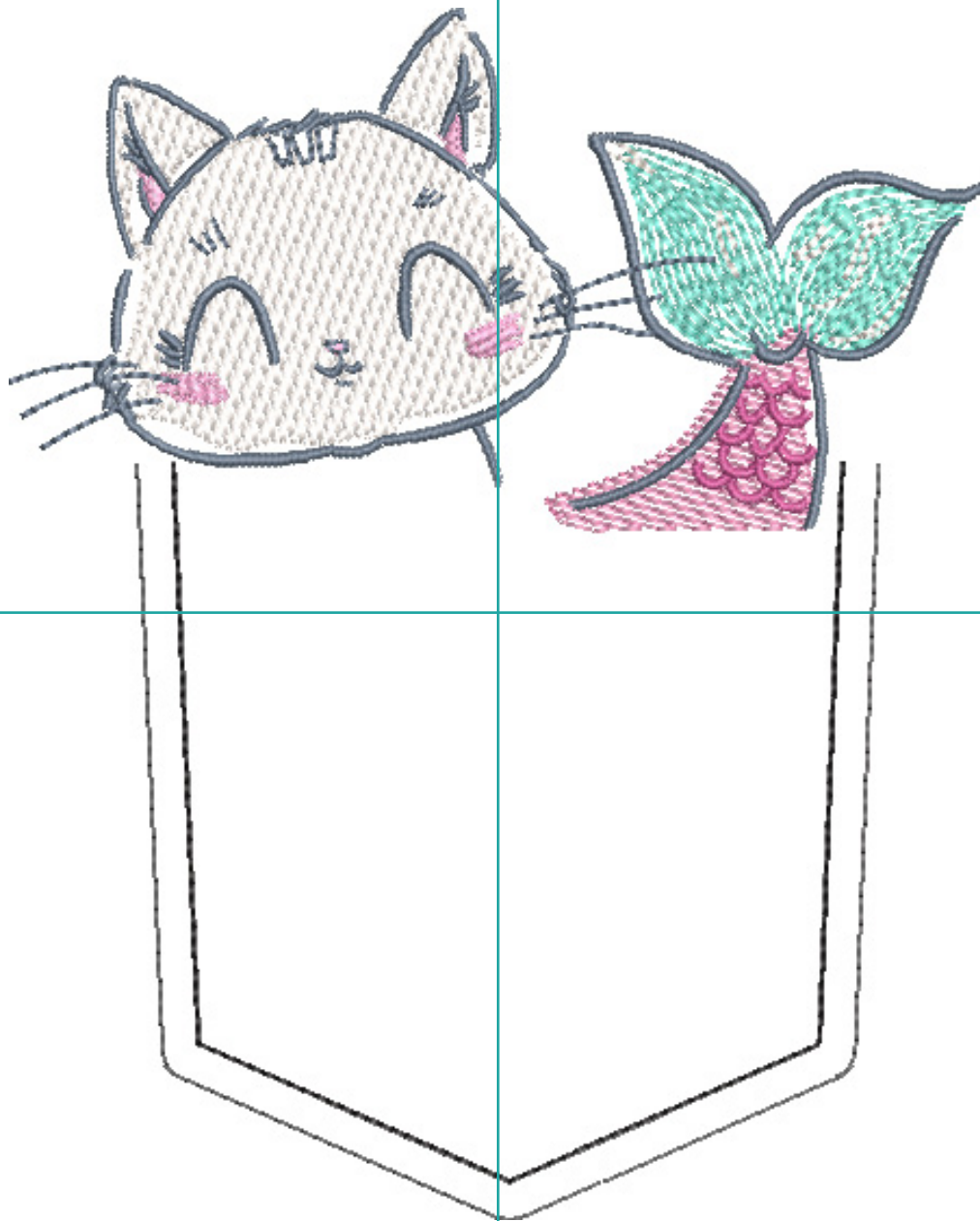

Note: to ensure proper placement, print the design template at 100% scale.

# CENTERPOINT



51240-06

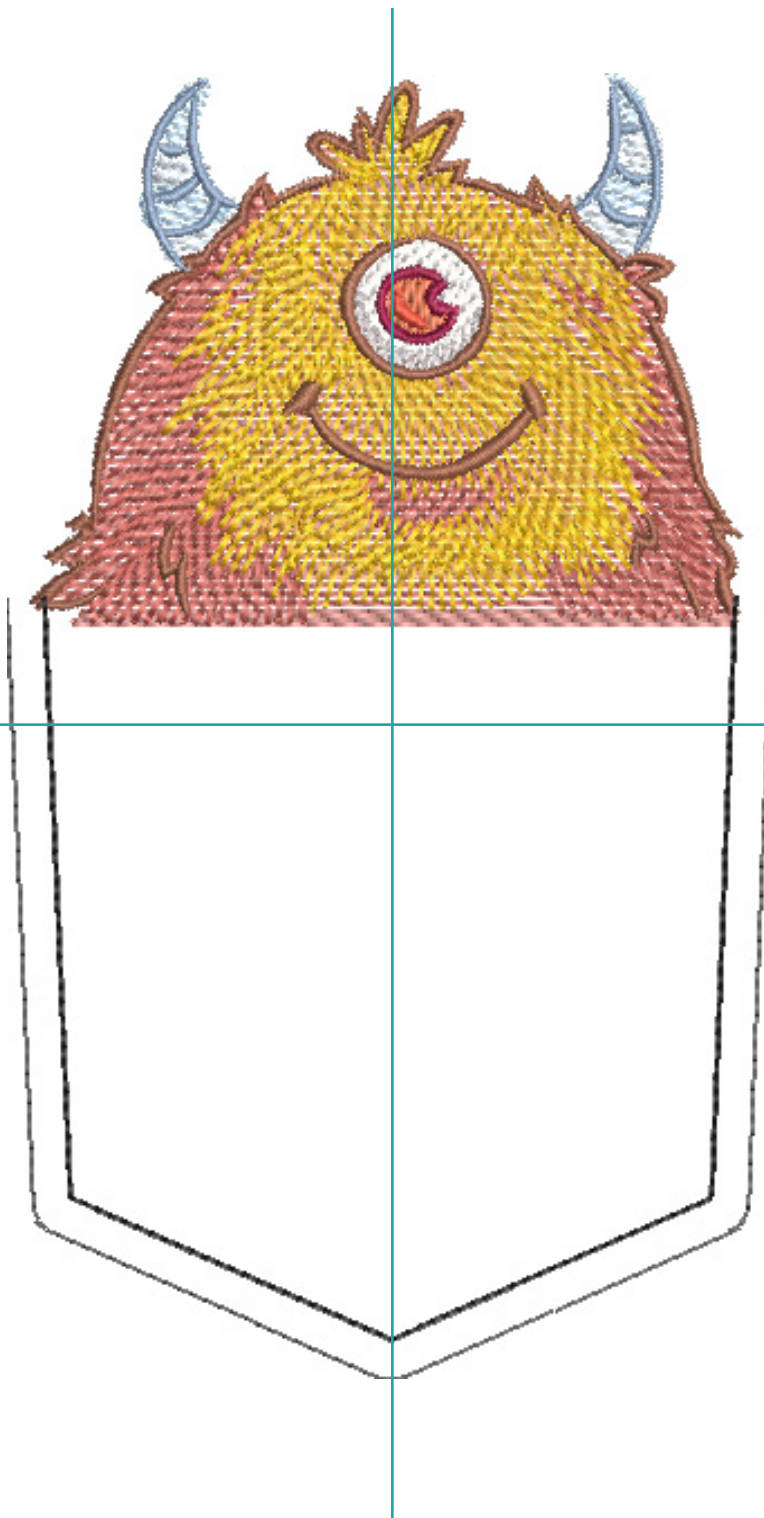

Note: to ensure proper placement, print the design template at 100% scale.



# CENTERPOINT



51240-08

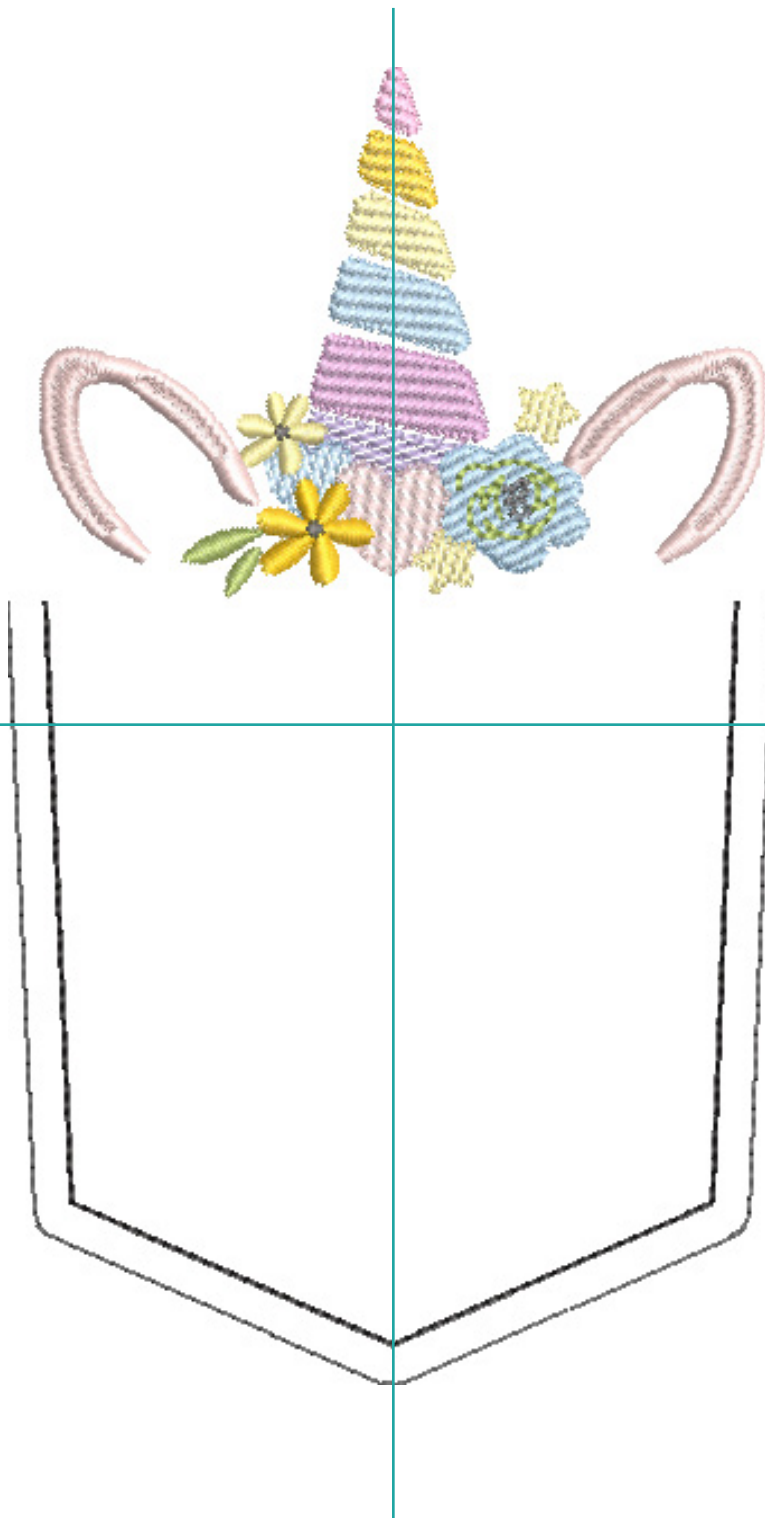

Note: to ensure proper placement, print the design template at 100% scale.

# CENTERPOINT



51240-10

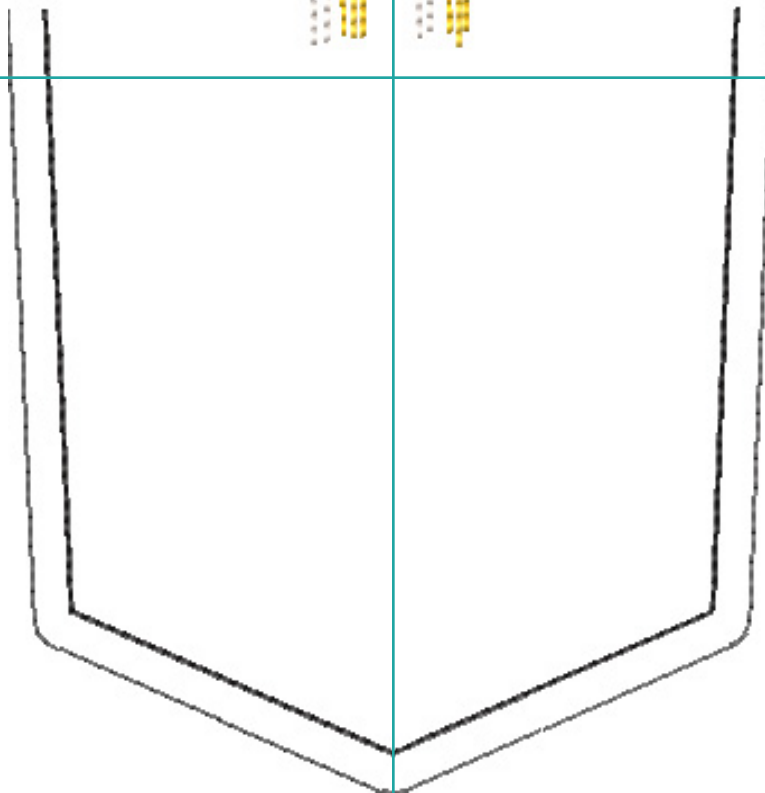
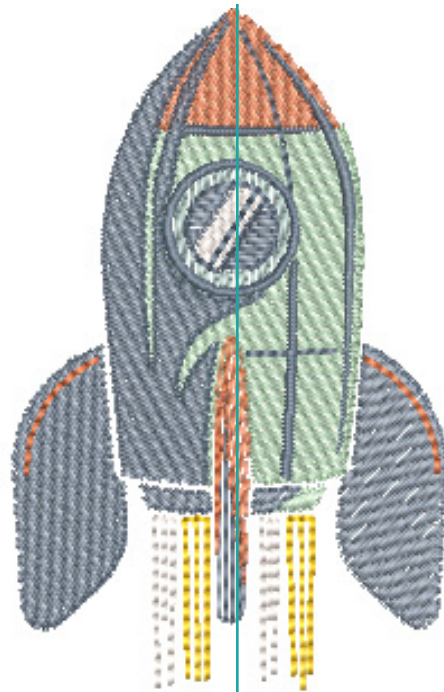

Note: to ensure proper placement, print the design template at 100% scale.

# CENTERPOINT



51240-12

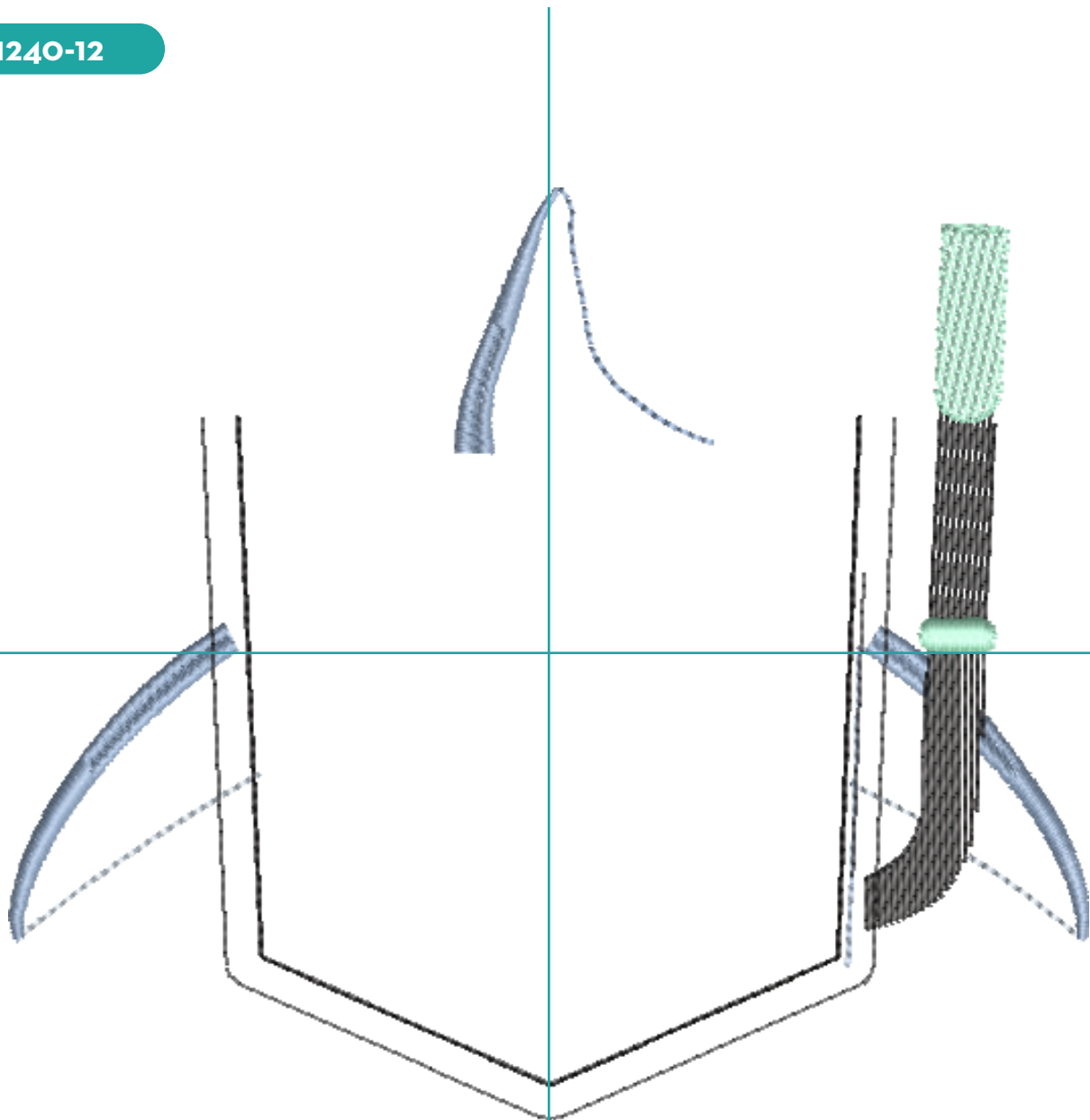

Note: to ensure proper placement, print the design template at 100% scale.

# CENTERPOINT



51240-14

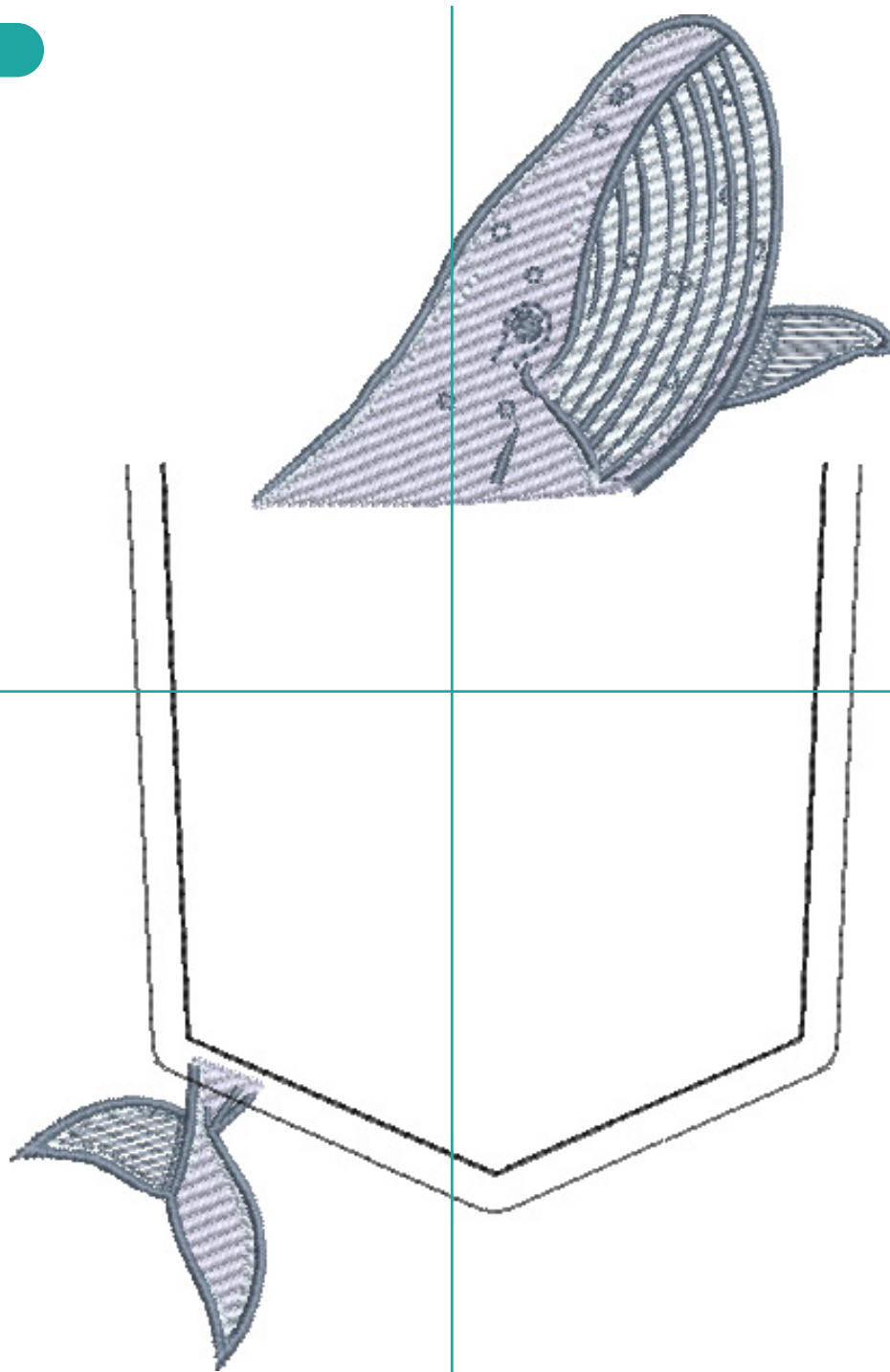

Note: to ensure proper placement, print the design template at 100% scale.



# CENTERPOINT



51240-16

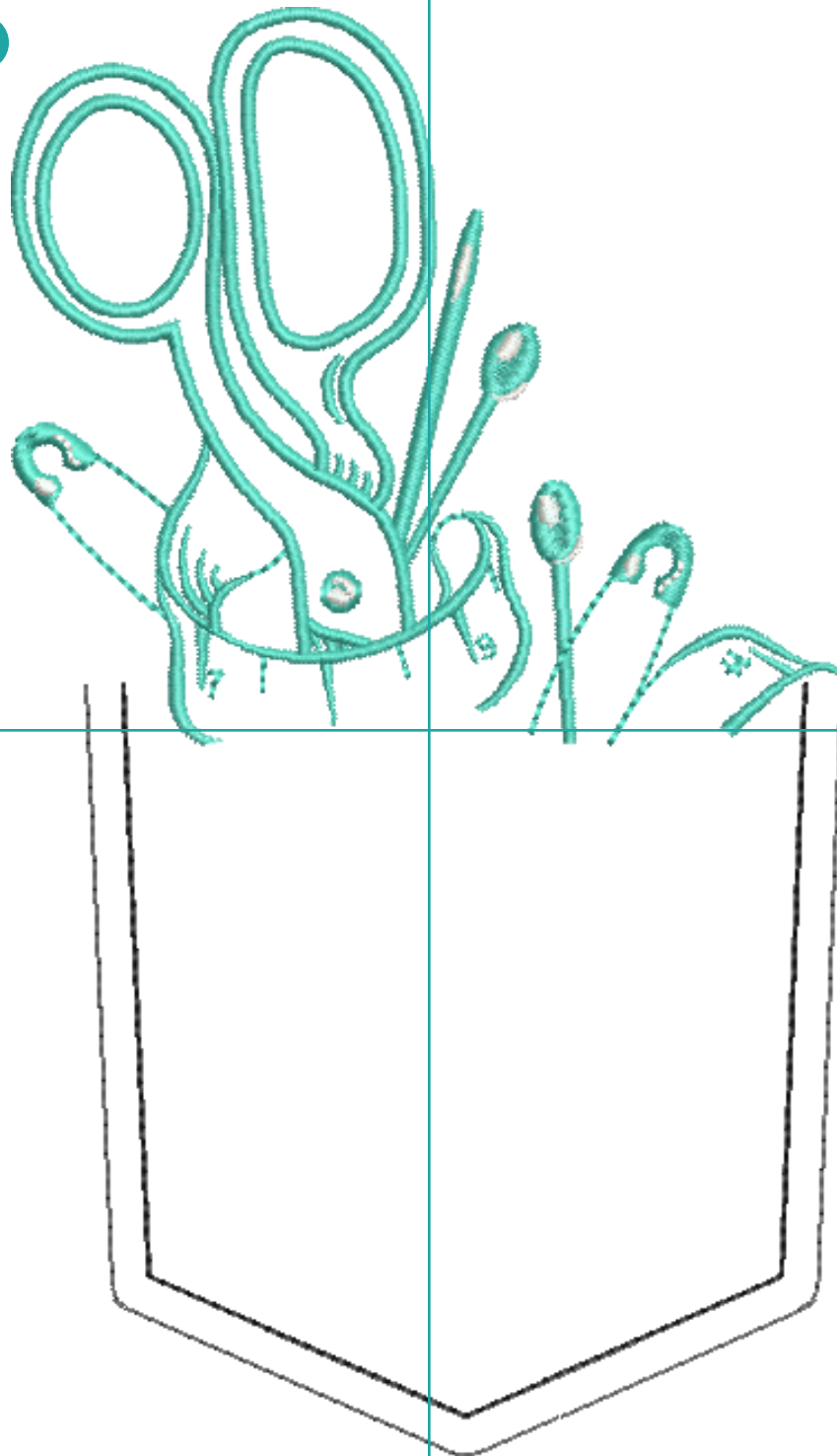

Note: to ensure proper placement, print the design template at 100% scale.

# CENTERPOINT



51240-18

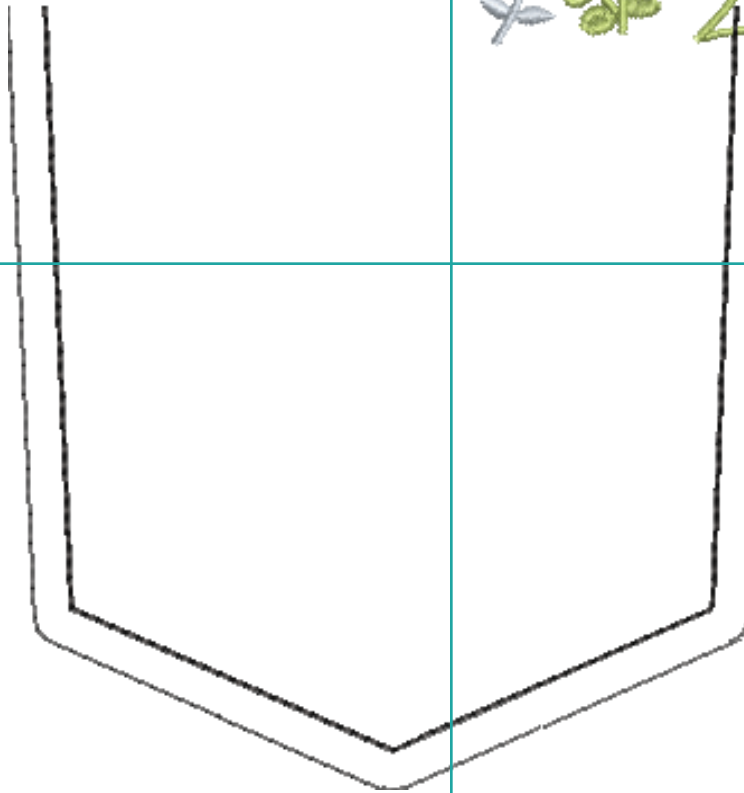

Note: to ensure proper placement, print the design template at 100% scale.

# CENTERPOINT



51240-20

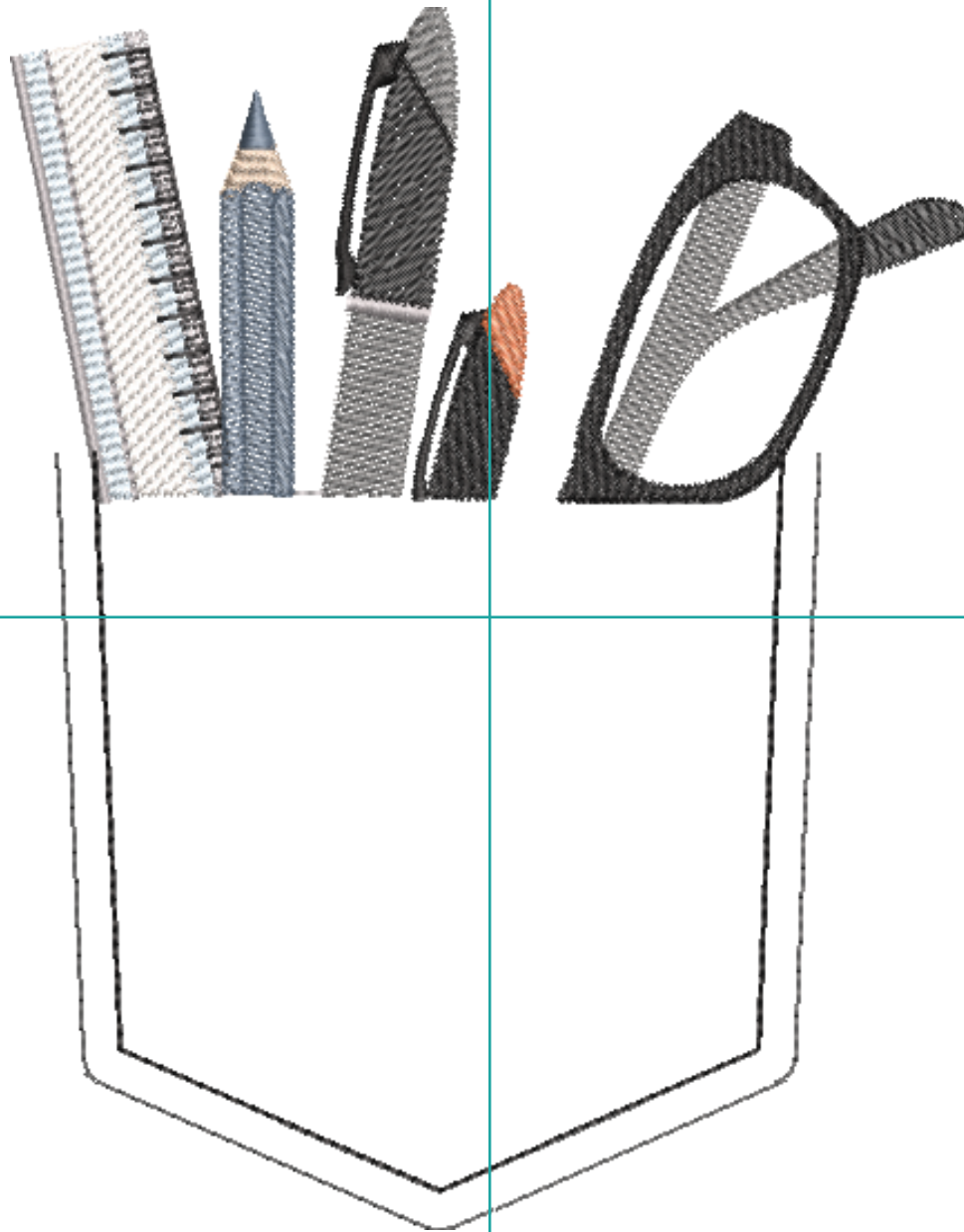

Note: to ensure proper placement, print the design template at 100% scale.

# CENTERPOINT



51240-22

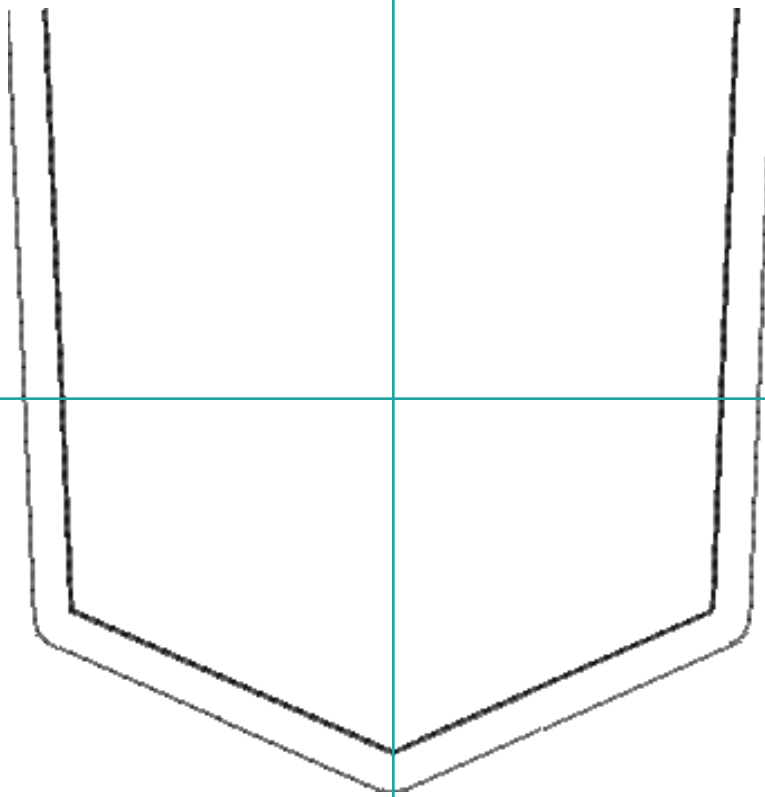

Note: to ensure proper placement, print the design template at 100% scale.



# CENTERPOINT



51240-24

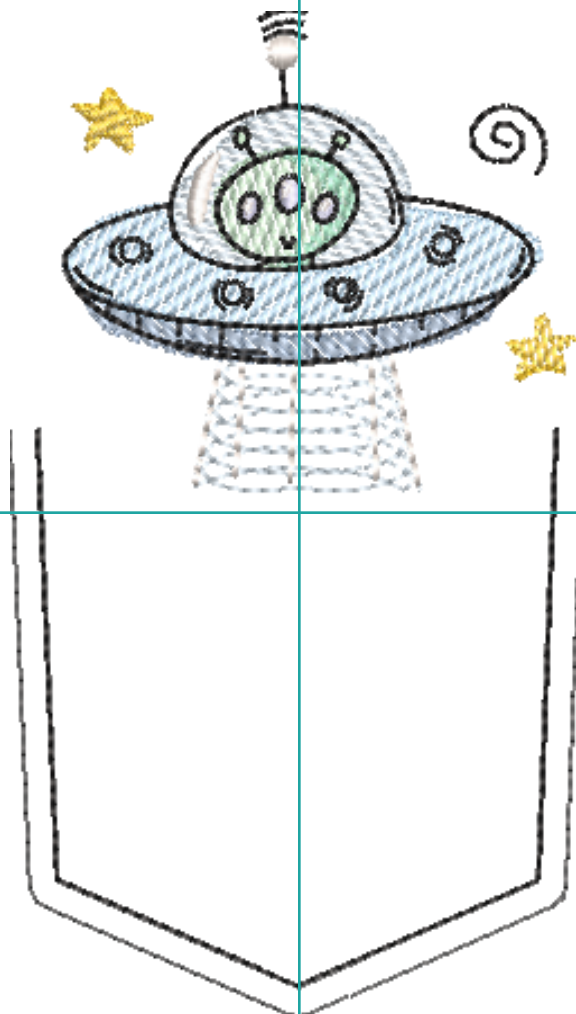

Note: to ensure proper placement, print the design template at 100% scale.

# CENTERPOINT



51240-26

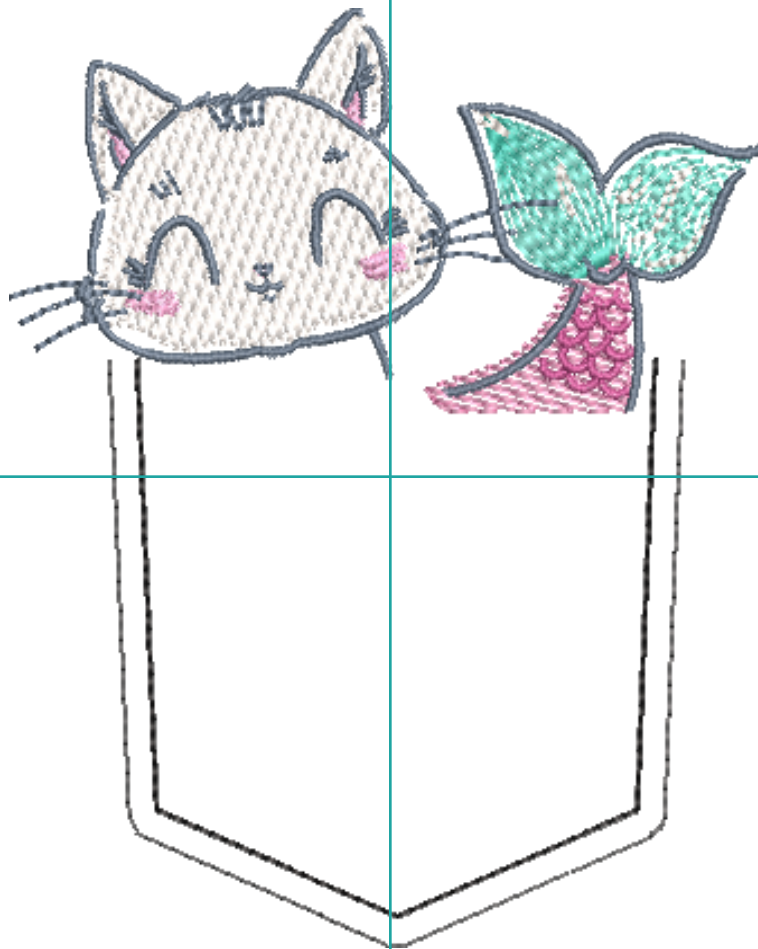

Note: to ensure proper placement, print the design template at 100% scale.

# CENTERPOINT



51240-28

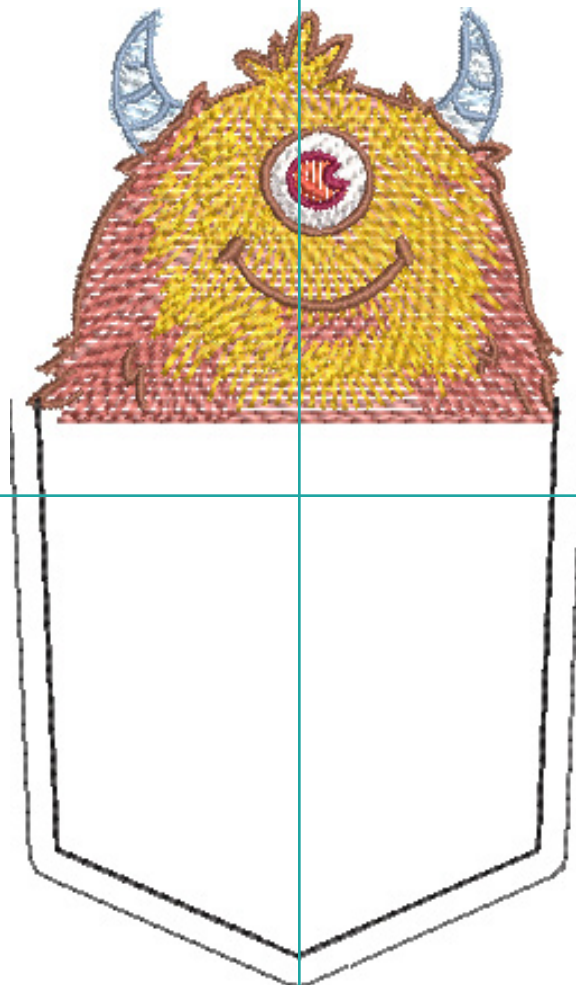

Note: to ensure proper placement, print the design template at 100% scale.

# CENTERPOINT



51240-30

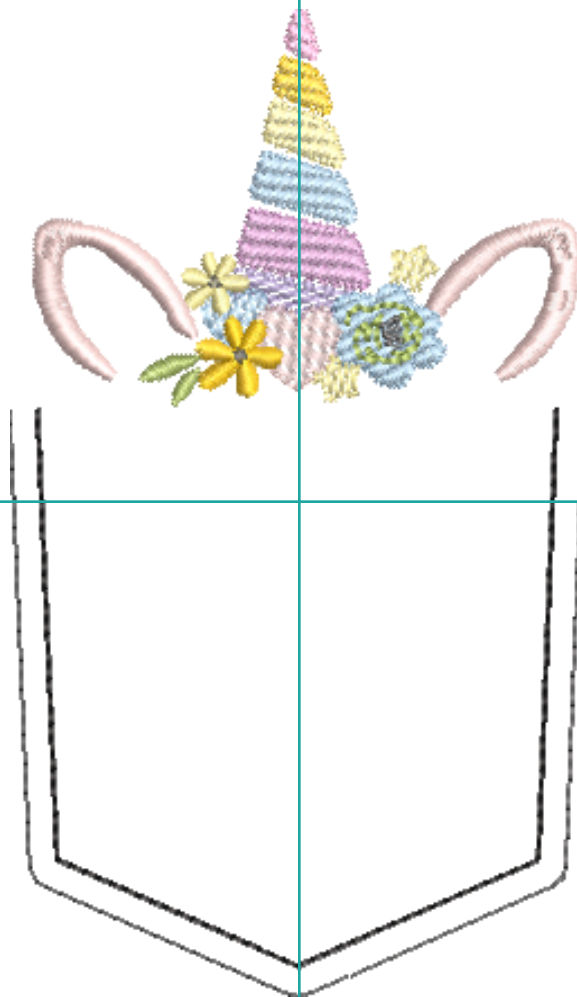

Note: to ensure proper placement, print the design template at 100% scale.



# CENTERPOINT



51240-32

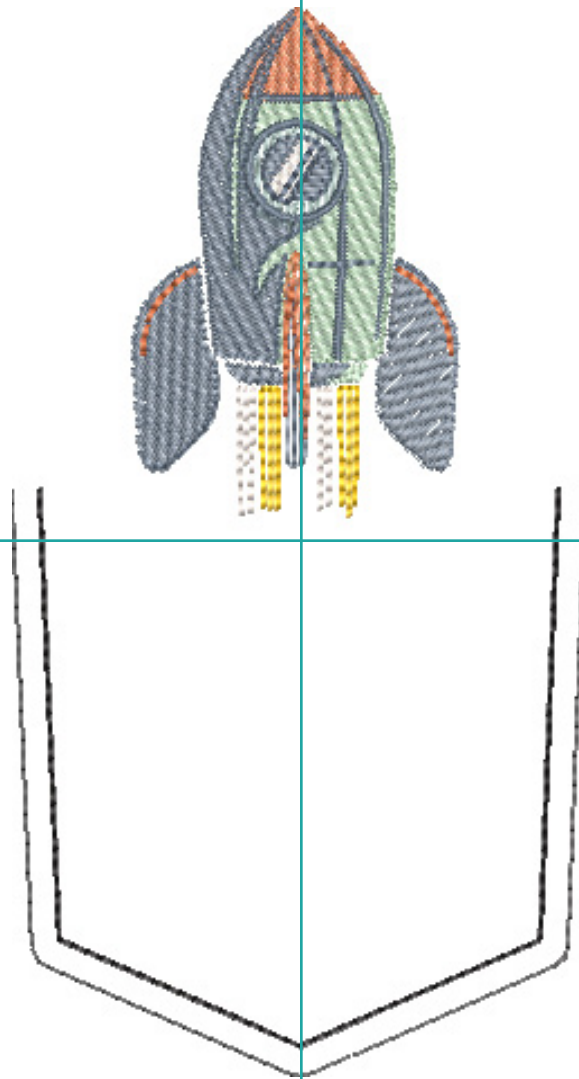

Note: to ensure proper placement, print the design template at 100% scale.

# CENTERPOINT



51240-34

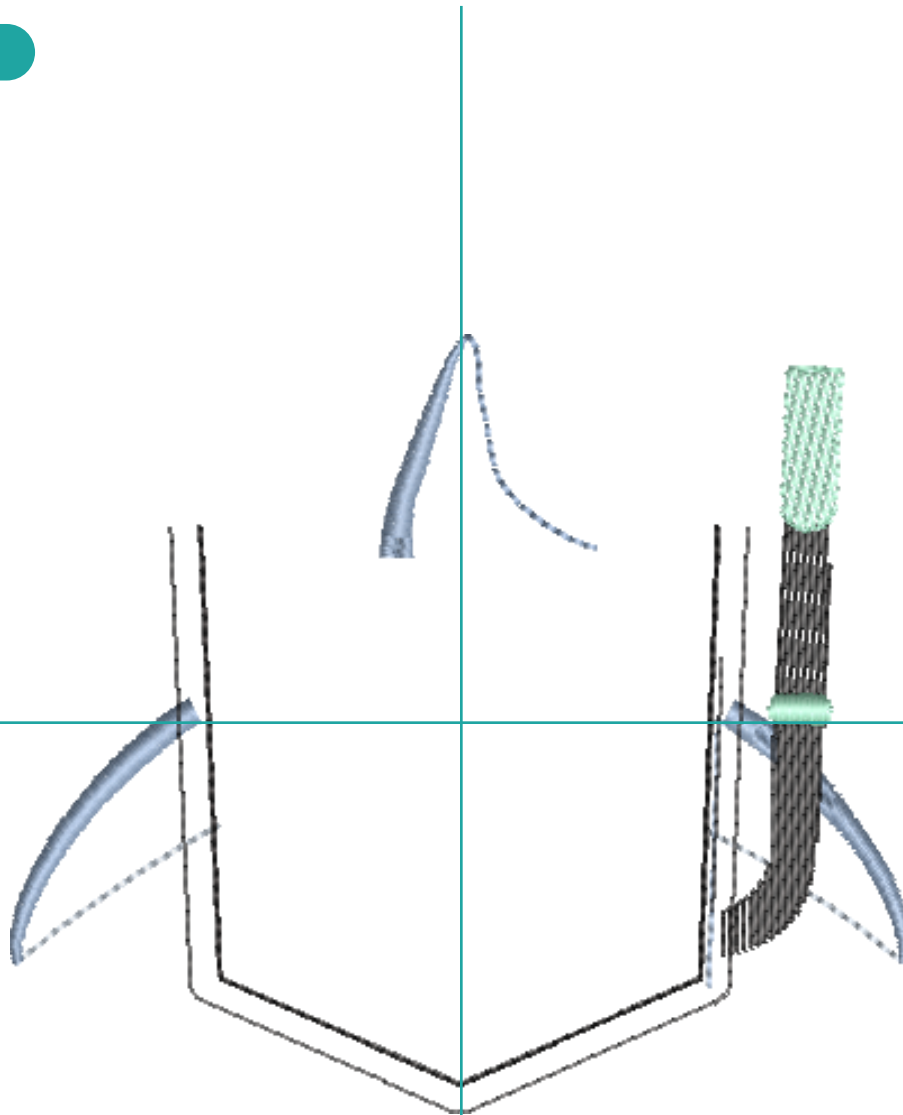

Note: to ensure proper placement, print the design template at 100% scale.

# CENTERPOINT



51240-36

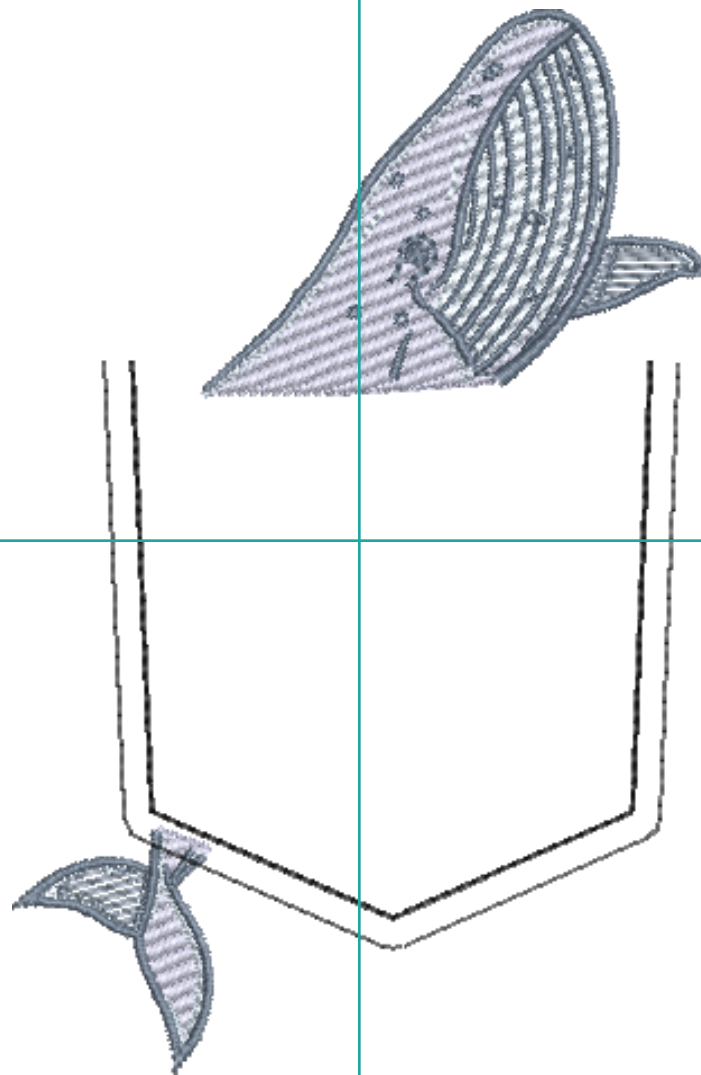

Note: to ensure proper placement, print the design template at 100% scale.

# CENTERPOINT



51240-38

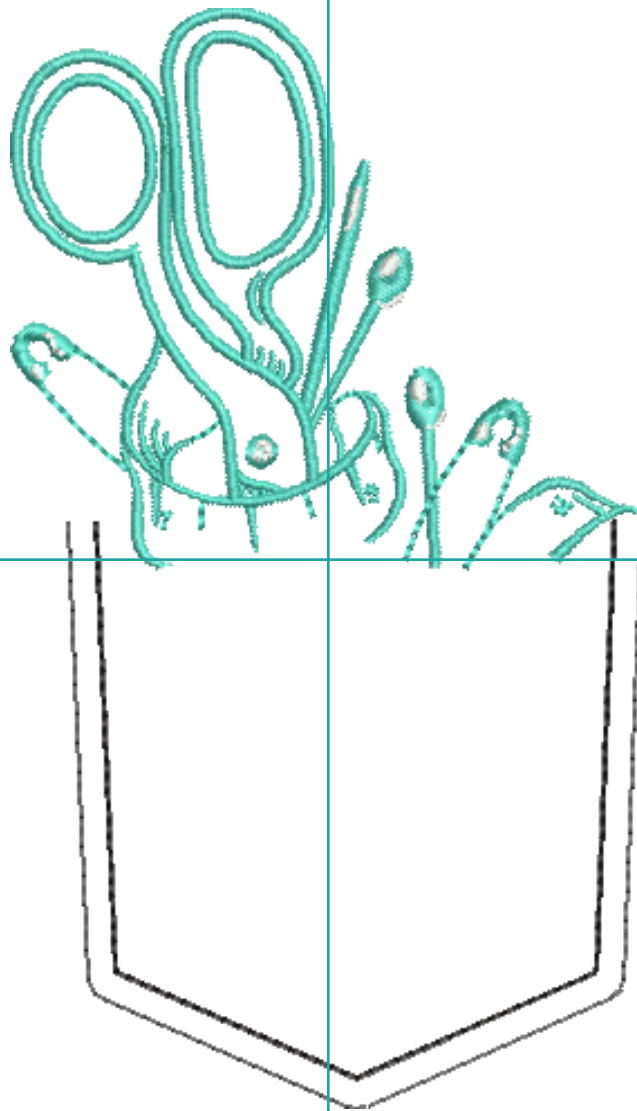

Note: to ensure proper placement, print the design template at 100% scale.



# CENTERPOINT



51240-40

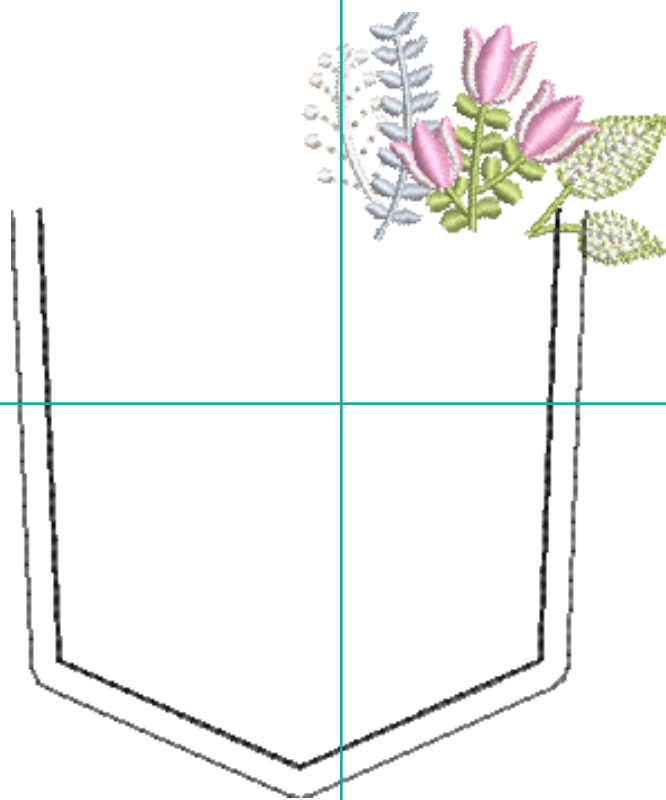

Note: to ensure proper placement, print the design template at 100% scale.

# CENTERPOINT



51240-42

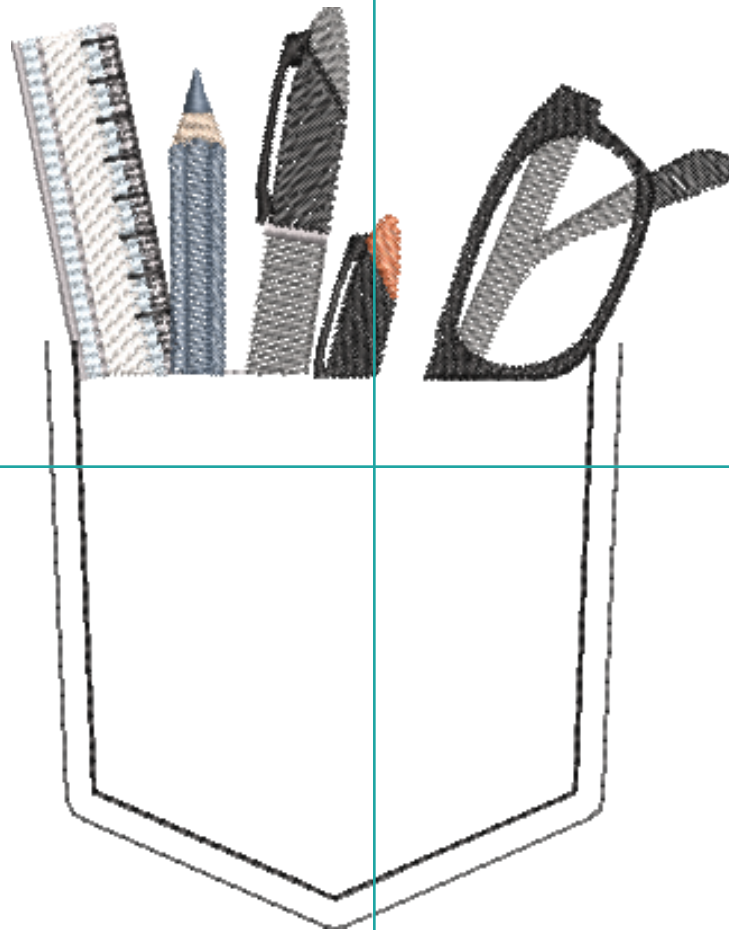

Note: to ensure proper placement, print the design template at 100% scale.

# CENTERPOINT



51240-44

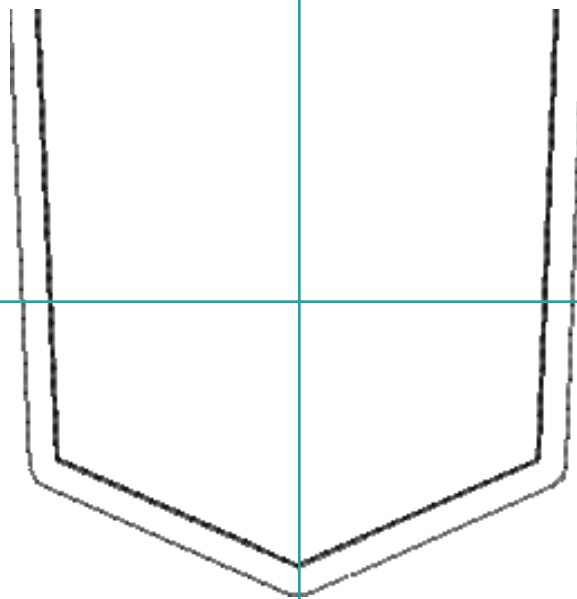

Note: to ensure proper placement, print the design template at 100% scale.