



#51254
3 DESIGNS



FLORAL BLOOMING PIN CUSHIONS

It is a violation of Copyright law to make and distribute copies of electronic designs or artwork.
Electronic designs are licensed to the original purchaser for use at one location. ©2021 OESD, LLC. All rights reserved.

MATERIALS



Isacord Thread Colors

0704 Gold
2155 Pink Tulip
2220 Tropicana
2864 Columbine
3045 Cachet
4113 Alexis Blue
4152 Serenity
5050 Luster
5324 Bright Green
5500 Limesdrop
5513 Ming
5830 Chartreuse

***Project instructions included after design list**

DESIGNS



Note: Some designs in this collection may have been created using unique special stitches and/or techniques. To preserve design integrity when rescaling or rotating designs in your software, always rescale or rotate designs using the handles directly on-screen.

FELT REQUIRED

51254-01 Flower 1 Purple Stamen FSA

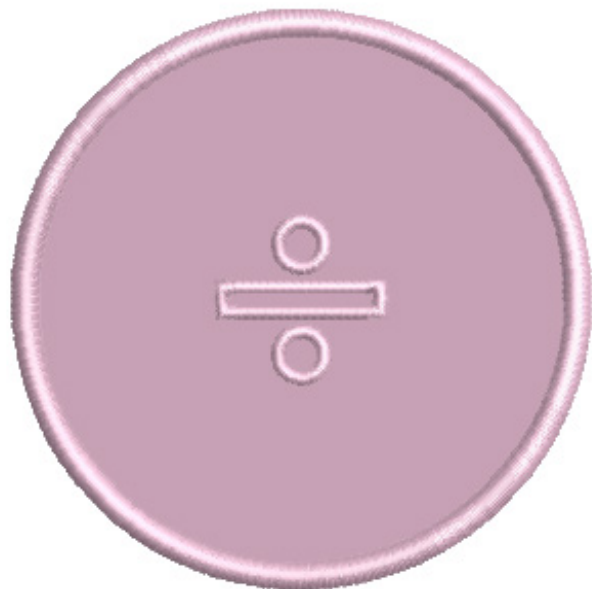

Size Inches: Size mm: Stitch Count:
3.31 X 3.31 in. 84.2 X 84.2 mm 3111 St.

- 1. Felt Placement Stitch..... 3045
- 2. Cut Line and Tackdown..... 3045
- 3. Pocket and Ribbon Holes 3045
- 4. Felt Placement Stitch..... 3045
- 5. Cut Line and Tackdown..... 3045
- 6. Cover Stitch..... 3045

FELT REQUIRED

51254-02 Flower 1 Light Aqua Petals FSA

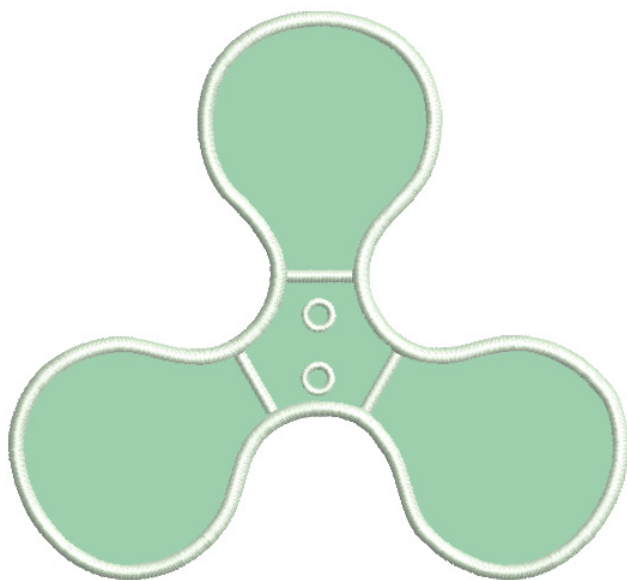

Size Inches: Size mm: Stitch Count:
5.54 X 6.04 in. 140.8 X 153.5 mm 6188 St.

- 1. Felt Placement Stitch.....5050
- 2. Cut Line and Tackdown.....5050
- 3. Pocket Edges Cover Stitch5050
- 4. Felt Placement Stitch.....5050
- 5. Cut Line and Tackdown.....5050
- 6. Cover Stitch and Ribbon Holes5050

DESIGNS



Note: Some designs in this collection may have been created using unique special stitches and/or techniques. To preserve design integrity when rescaling or rotating designs in your software, always rescale or rotate designs using the handles directly on-screen.

FELT REQUIRED

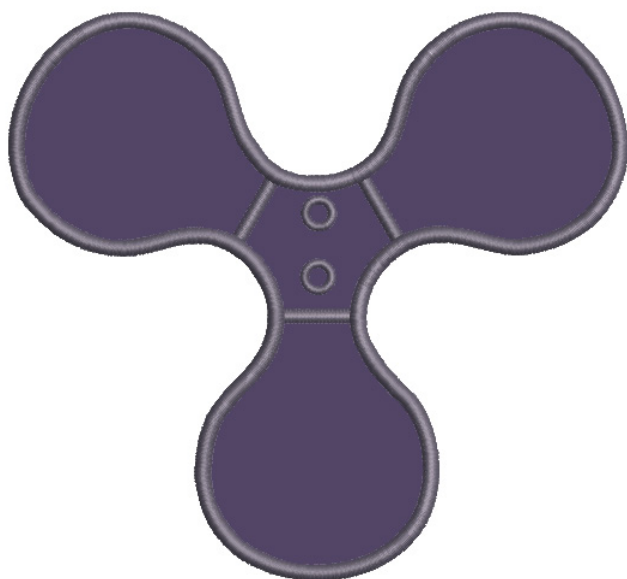

51254-03 Flower 1 Lavender Petals FSA

Size Inches: Size mm: Stitch Count:
5.54 X 6.04 in. 140.8 X 153.5 mm 6188 St.

- 1. Felt Placement Stitch.....2864
- 2. Cut Line and Tackdown.....2864
- 3. Pocket Edges Cover Stitch.....2864
- 4. Felt Placement Stitch.....2864
- 5. Cut Line and Tackdown.....2864
- 6. Cover Stitch and Ribbon Holes2864

FELT REQUIRED



51254-04 Flower 1 Double Leaf FSA

Size Inches: Size mm: Stitch Count:
4.09 X 4.59 in. 103.8 X 116.5 mm 3526 St.

- 1. Felt Placement Stitch.....5324
- 2. Cut Line and Tackdown.....5324
- 3. Cover Stitch and Ribbon Hole5324

DESIGNS



Note: Some designs in this collection may have been created using unique special stitches and/or techniques. To preserve design integrity when rescaling or rotating designs in your software, always rescale or rotate designs using the handles directly on-screen.

FELT REQUIRED



51254-05 Flower 1 Single Leaf FSA

Size Inches: Size mm: Stitch Count:
4.32 X 2.22 in. 109.8 X 56.3 mm 2310 St.

- 1. Felt Placement Stitch.....5324
- 2. Cut Line and Tackdown.....5324
- 3. Cover Stitch and Ribbon Hole5324

FELT REQUIRED

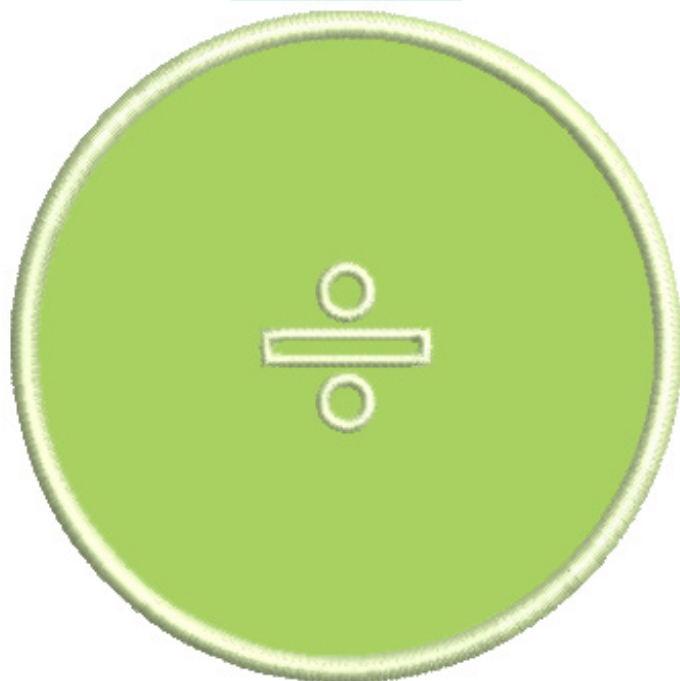

51254-06 Flower 2 Bright Green Stamen FSA

Size Inches: Size mm: Stitch Count:
3.83 X 3.83 in. 97.3 X 97.3 mm 3464 St.

- 1. Felt Placement Stitch..... 5830
- 2. Cut Line and Tackdown..... 5830
- 3. Pocket and Ribbon Holes 5830
- 4. Felt Placement Stitch..... 5830
- 5. Cut Line and Tackdown..... 5830
- 6. Cover Stitch..... 5830

DESIGNS



Note: Some designs in this collection may have been created using unique special stitches and/or techniques. To preserve design integrity when rescaling or rotating designs in your software, always rescale or rotate designs using the handles directly on-screen.

FELT REQUIRED

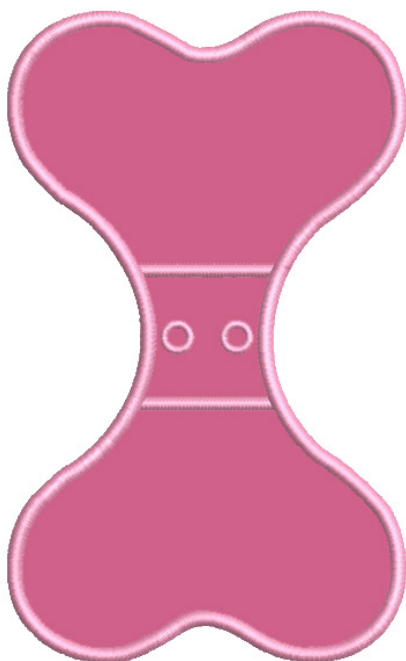

51254-07 Flower 2 Pink Petals FSA

Size Inches: Size mm: Stitch Count:
6.59 X 4.05 in. 167.5 X 102.8 mm 6104 St.

- 1. Felt Placement Stitch.....2220
- 2. Cut Line and Tackdown.....2220
- 3. Pocket Edges Cover Stitch2220
- 4. Felt Placement Stitch.....2220
- 5. Cut Line and Tackdown.....2220
- 6. Cover Stitch and Ribbon Holes2220

FELT REQUIRED

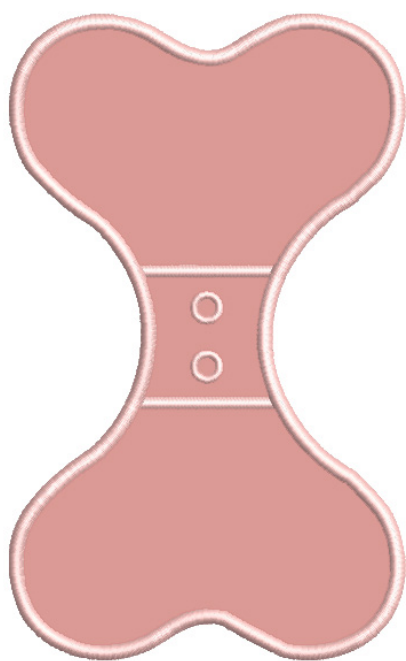

51254-08 Flower 2 Light Pink Petals FSA

Size Inches: Size mm: Stitch Count:
6.59 X 4.05 in. 167.5 X 102.8 mm 6099 St.

- 1. Felt Placement Stitch.....2155
- 2. Cut Line and Tackdown.....2155
- 3. Pocket Edges Cover Stitch2155
- 4. Felt Placement Stitch.....2155
- 5. Cut Line and Tackdown.....2155
- 6. Cover Stitch and Ribbon Holes2155

DESIGNS



Note: Some designs in this collection may have been created using unique special stitches and/or techniques. To preserve design integrity when rescaling or rotating designs in your software, always rescale or rotate designs using the handles directly on-screen.

FELT REQUIRED

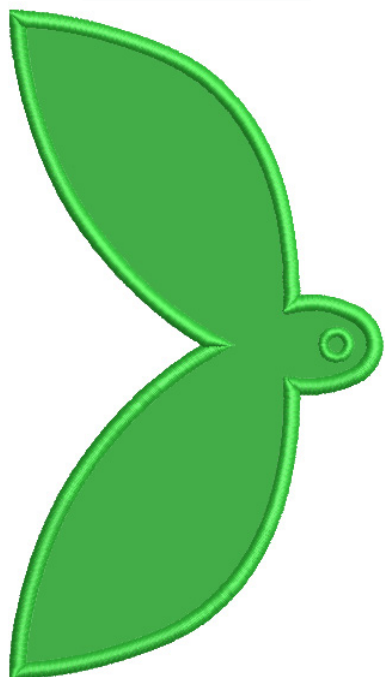

51254-09 Flower 2 Double Leaf FSA

Size Inches: Size mm: Stitch Count:
6.55 X 3.65 in. 166.3 X 92.8 mm 4046 St.

- 1. Felt Placement Stitch.....5500
- 2. Cut Line and Tackdown.....5500
- 3. Cover Stitch and Ribbon Hole5500

FELT REQUIRED



51254-10 Flower 2 Single Leaf FSA

Size Inches: Size mm: Stitch Count:
4.94 X 2.17 in. 125.5 X 55.0 mm 2457 St.

- 1. Felt Placement Stitch.....5500
- 2. Cut Line and Tackdown.....5500
- 3. Cover Stitch and Ribbon Hole5500

DESIGNS



Note: Some designs in this collection may have been created using unique special stitches and/or techniques. To preserve design integrity when rescaling or rotating designs in your software, always rescale or rotate designs using the handles directly on-screen.

FELT REQUIRED



51254-11 Flower 3 Yellow Stamen FSA

Size Inches: Size mm: Stitch Count:
3.31 X 3.31 in. 84.2 X 84.2 mm 3158 St.

- 1. Felt Placement Stitch..... 0704
- 2. Cut Line and Tackdown..... 0704
- 3. Pocket and Ribbon Holes 0704
- 4. Felt Placement Stitch..... 0704
- 5. Cut Line and Tackdown..... 0704
- 6. Cover Stitch..... 0704

FELT REQUIRED

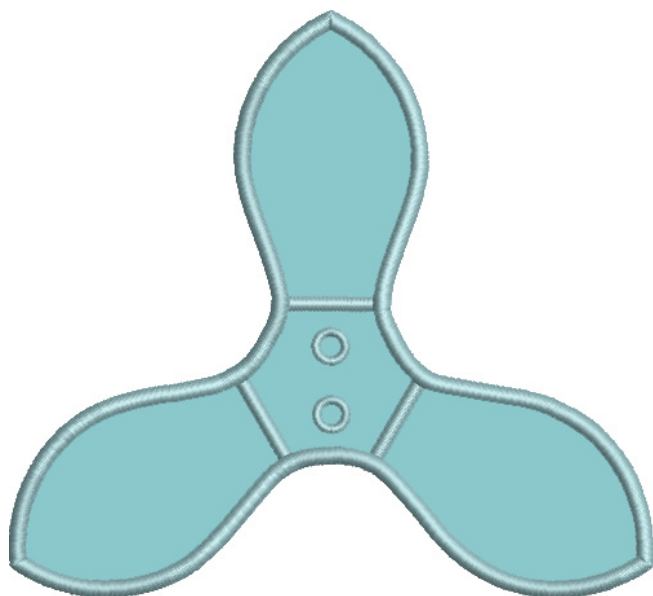

51254-12 Flower 3 Light Blue Petals FSA

Size Inches: Size mm: Stitch Count:
5.33 X 5.84 in. 135.3 X 148.3 mm 5794 St.

- 1. Felt Placement Stitch..... 4152
- 2. Cut Line and Tackdown..... 4152
- 3. Pocket Edges Cover Stitch 4152
- 4. Felt Placement Stitch..... 4152
- 5. Cut Line and Tackdown..... 4152
- 6. Cover Stitch and Ribbon Holes 4152

DESIGNS



Note: Some designs in this collection may have been created using unique special stitches and/or techniques. To preserve design integrity when rescaling or rotating designs in your software, always rescale or rotate designs using the handles directly on-screen.

FELT REQUIRED

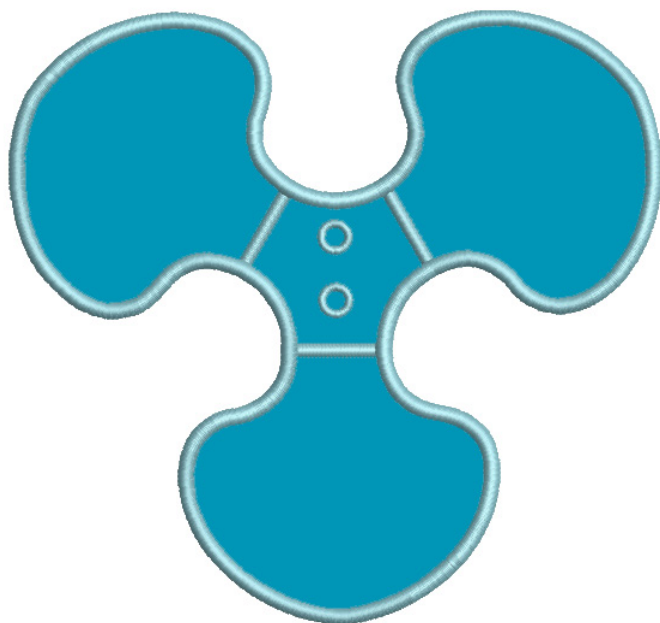

51254-13 Flower 3 Blue Petals FSA

Size Inches: Size mm: Stitch Count:
6.00 X 6.37 in. 152.4 X 161.8 mm 7638 St.

- 1. Felt Placement Stitch.....4113
- 2. Cut Line and Tackdown.....4113
- 3. Pocket Edges Cover Stitch.....4113
- 4. Felt Placement Stitch.....4113
- 5. Cut Line and Tackdown.....4113
- 6. Cover Stitch and Ribbon Holes4113

FELT REQUIRED

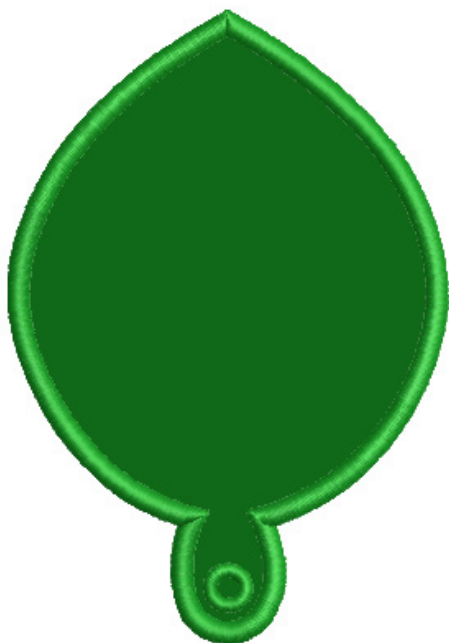

51254-14 Flower 3 Wide Leaf FSA

Size Inches: Size mm: Stitch Count:
4.51 X 3.14 in. 114.5 X 79.8 mm 2623 St.

- 1. Felt Placement Stitch.....5513
- 2. Cut Line and Tackdown.....5513
- 3. Cover Stitch and Ribbon Hole5513

DESIGNS



Note: Some designs in this collection may have been created using unique special stitches and/or techniques. To preserve design integrity when rescaling or rotating designs in your software, always rescale or rotate designs using the handles directly on-screen.

FELT REQUIRED



51254-15 Flower 3 Narrow Leaf FSA

Size Inches: Size mm: Stitch Count:
4.88 X 1.51 in. 123.9 X 38.4 mm 2354 St.

- 1. Felt Placement Stitch.....5513
- 2. Cut Line and Tackdown.....5513
- 3. Cover Stitch and Ribbon Hole5513

COLLECTION SUPPLIES



Stabilizer

- OESD AquaMesh
- OESD BadgeMaster

Fabric/Textiles

1 - 9" x 12" sheet felt of each of the following colors:

Flower 1

- Purple
- Lavender
- Light Aqua
- Dark Green

Flower 2

- Pink
- Light Pink
- Bright Green
- Green

Flower 3

- Blue
- Light Blue
- Yellow
- Green

Notions & Tools

- OESD Alligator Clamps
- Chopstick or 12" ¼ round dowel for stuffing poly-fil (optional)
- OESD Expert Embroidery Tape WashAway
- OESD Perfect Punch Tool
- Buttonhole cutter or utility knife and cutting mat
- Hand sewing needle (optional)

Isacord Thread Colors

- As per thread chart
- Match bobbin thread to top thread for all designs.

SUMMARY



Flower 1

51254-01

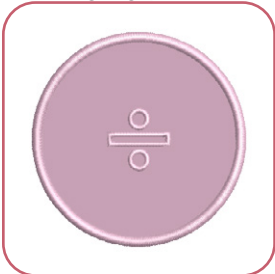

Requires 1 Design

51254-02

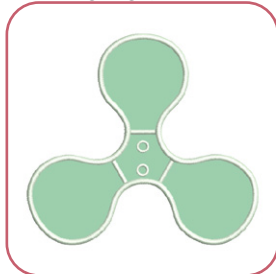

Requires 1 Design

51254-03

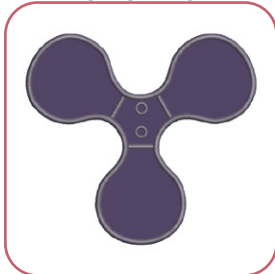

Requires 1 Design

51254-04

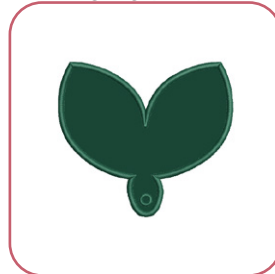

Requires 1 Design

51254-05



Requires 1 Design

Flower 2

51254-06

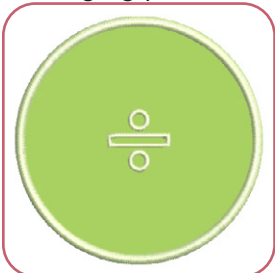

Requires 1 Design

51254-07

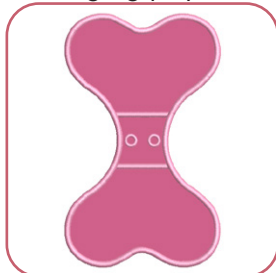

Requires 1 Design

51254-08

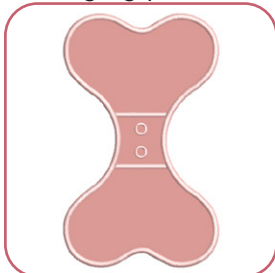

Requires 1 Design

51254-09

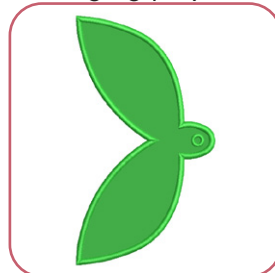

Requires 1 Design

51254-10

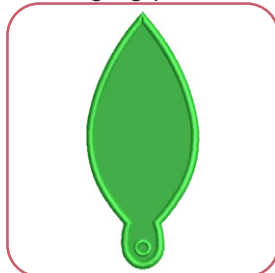

Requires 1 Design

Flower 3

51254-11

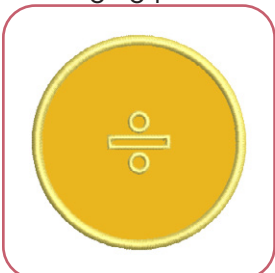

Requires 1 Design

51254-12

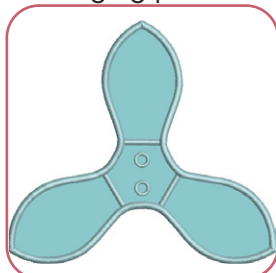

Requires 1 Design

51254-13

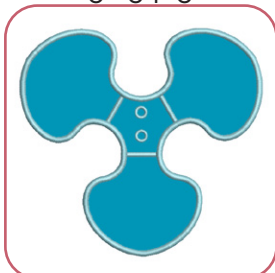

Requires 1 Design

51254-14

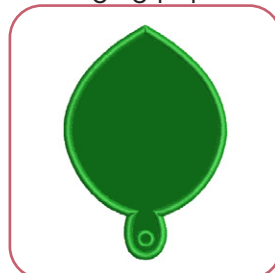

Requires 1 Design

51254-15

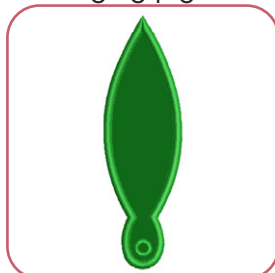

Requires 1 Design

FLOWER STAMEN



Step 1

- Hoop one layer of OESD AquaMesh and one layer of OESD BadgeMaster.



Step 2

- Stitch Machine Step 1, Felt Placement Stitch.



Step 3

- Cover the placement line completely with felt.
- Tape in place to secure.

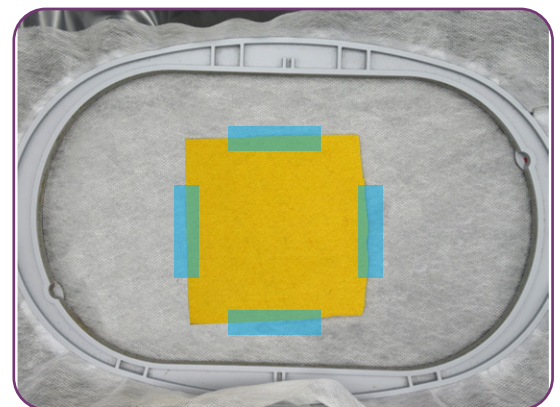

FLOWER STAMEN



Step 4

- Stitch Machine Step 2, Cut Line and Tackdown.

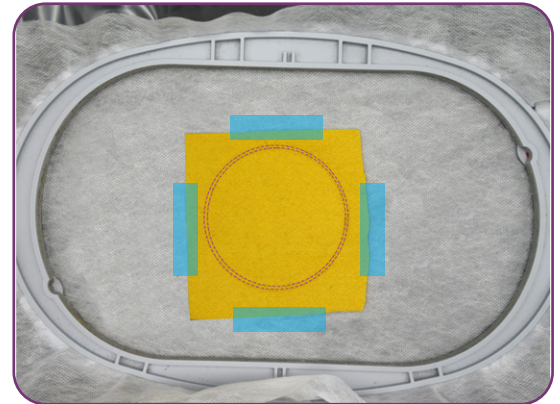

Step 5

- Remove the hoop from the machine, but NOT the project from the hoop.
- Trim the excess fabric as close to the tackdown stitching as possible. If the outermost stitches are cut, the inner stitches will still hold the applique in place.
- Tip: If the AquaMesh is cut or a hole is created while trimming the fabric, use OESD Expert Embroidery Tape WashAway as a patch.

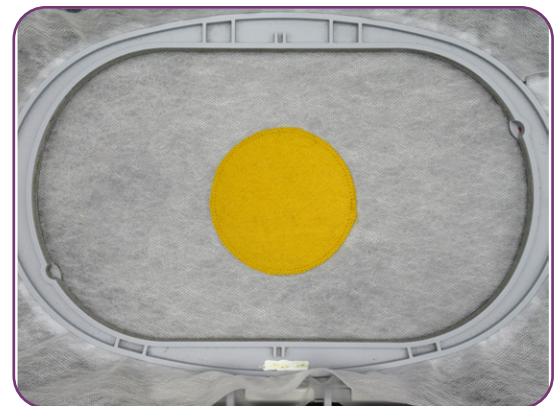

Step 6

- Return the hoop to the machine.
- Stitch Machine Step 3, Pocket and Ribbon Holes.



FLOWER STAMEN



Step 7

- Remove the hoop from the machine, but NOT the project from the hoop. Place hoop onto cutting mat. Using the 3mm attachment with the punch tool, punch holes in the eyelets. For placement, refer to the punch tool guides on page 26-28 of the instructions.
- Using a buttonhole cutter or utility knife, make a slit in the Pocket Hole. Take care to not cut the satin stitching. Refer to the punch tool guides on page xx for hole placement.

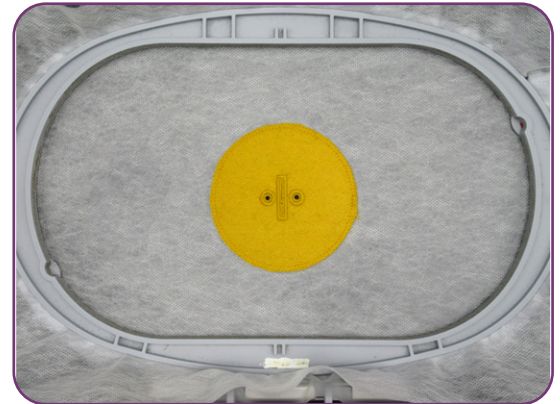

Step 8

- Return the hoop to the machine.
- Stitch Machine Step 4, Felt Placement Stitch.
- Cover the placement line completely with felt.
- Tape in place to secure.

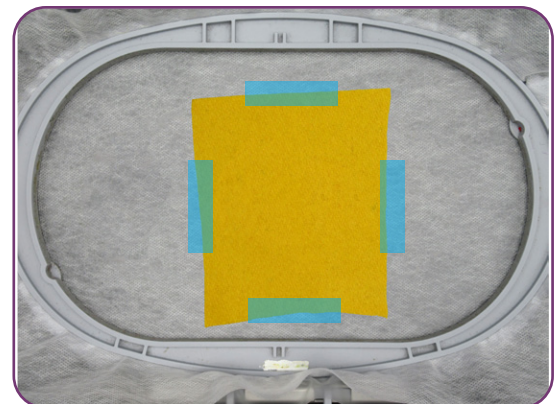

Step 9

- Stitch Machine Step 5, Cut Line and Tackdown.

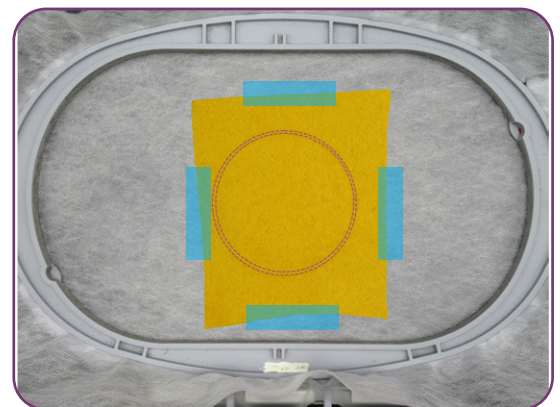

FLOWER STAMEN



Step 10

- Remove the hoop from the machine, but NOT the project from the hoop.
- Trim the excess fabric as close to the tackdown stitching as possible. If the outermost stitches are cut, the inner stitches will still hold the applique in place.
- Tip: If the AquaMesh is cut or a hole is created while trimming the fabric, simply use OESD Expert Embroidery Tape WashAway as a patch.

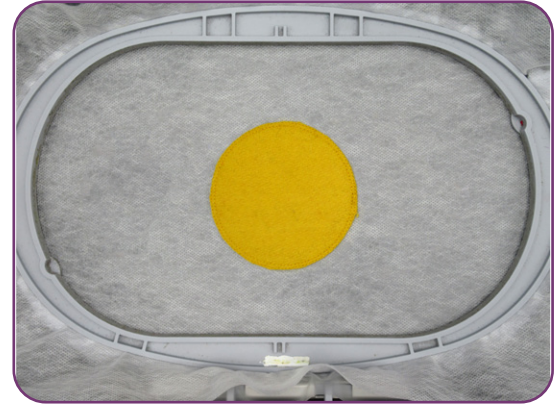

Step 11

- Return the hoop to the machine.
- Stitch Machine Step 6, Cover Stitch.
- Design is complete. Remove the project from the hoop and trim the stabilizer $\frac{1}{4}$ " - $\frac{1}{2}$ " outside the design.

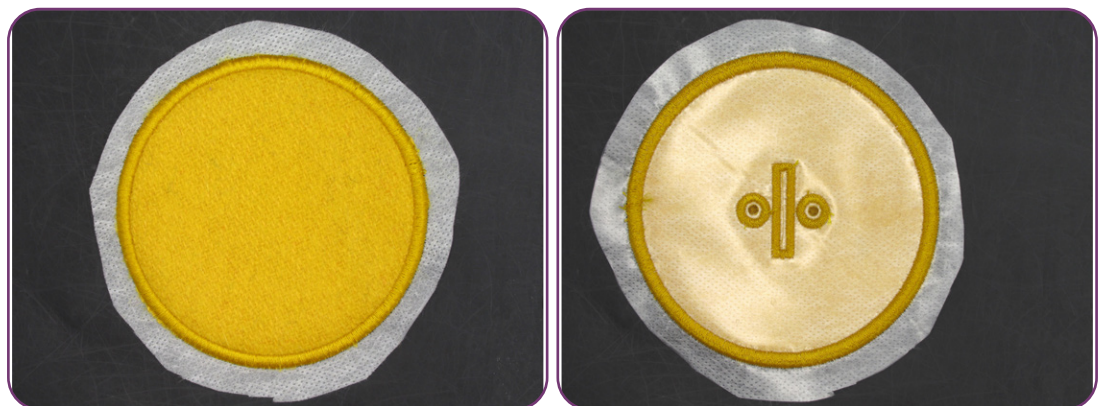

FLOWER STAMEN



Step 12

- Pull remaining BadgeMaster away from design
- Rinse each piece completely in warm running water until all trace of the stabilizer is dissolved.
- Lay face down on a non-stick surface to dry. Parchment paper or a cooling rack work well. This prevents the piece from curling.

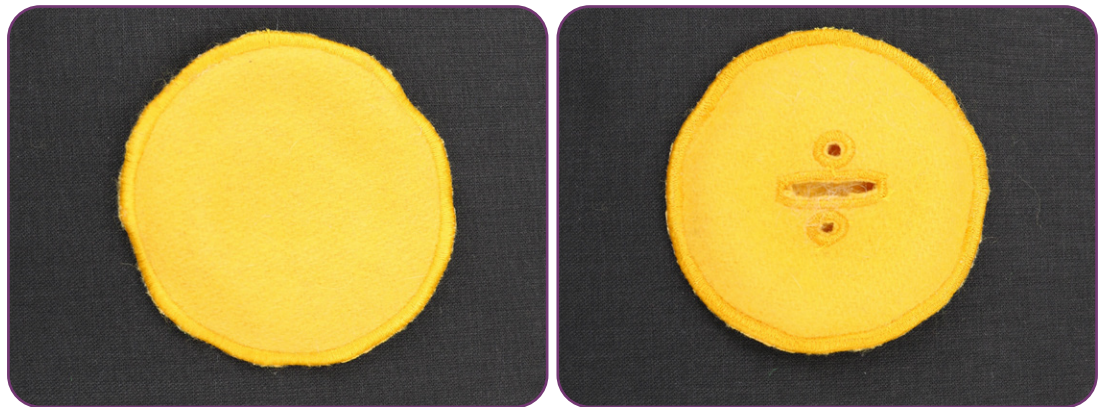

PETALS



Step 13

- Hoop one layer of OESD AquaMesh and one layer of OESD BadgeMaster.



Step 14

- Stitch Machine Step 1, Felt Placement Stitch.



Step 15

- Cover the placement lines completely with felt.
- Tape in place to secure.

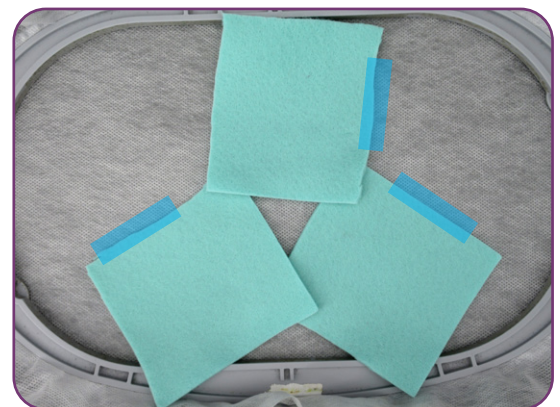

PETALS



Step 16

- Stitch Machine Step 2, Cut Line and Tackdown.

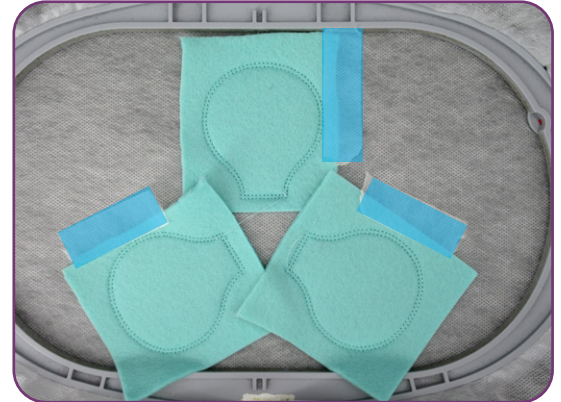

Step 17

- Remove the hoop from the machine, but NOT the project from the hoop.
- Trim the excess fabric as close to the tackdown stitching as possible. If the outermost stitches are cut, the inner stitches will still hold the applique in place.
- Tip: If the AquaMesh is cut or a hole is created while trimming the fabric, use OESD Expert Embroidery Tape WashAway as a patch.



Step 18

- Return the hoop to the machine.
- Stitch Machine Step 3, Pocket Edges and Cover Stitch.



PETALS



Step 19

- Stitch Machine Step 4, Felt Placement Stitch.
- Cover the placement line completely with felt.
- Optional, tape in place to secure.

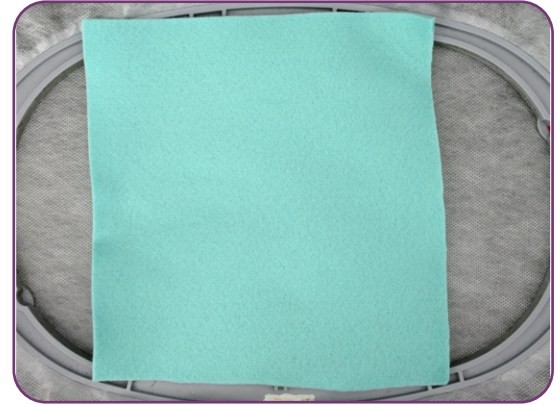

Step 20

- Stitch Machine Step 5, Cut Line and Tackdown.

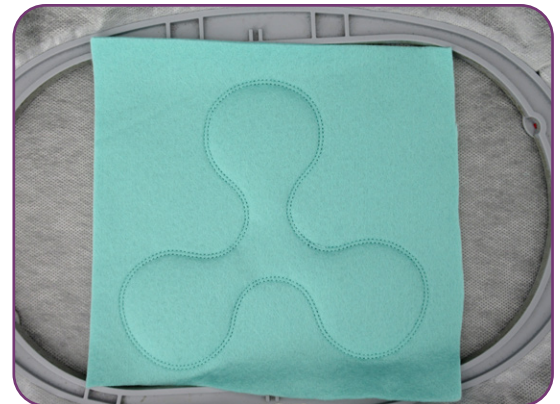

Step 21

- Remove the hoop from the machine, but NOT the project from the hoop.
- Trim the excess fabric as close to the tackdown stitching as possible. If the outermost stitches are cut, the inner stitches will still hold the applique in place.
- Tip: If the AquaMesh is cut or a hole is created while trimming the fabric, use OESD Expert Embroidery Tape WashAway as a patch.



PETALS



Step 22

- Return the hoop to the machine.
- Stitch Machine Step 6, Cover Stitch and Ribbon Holes.
- Design is complete. Remove the project from the hoop and trim the stabilizer $\frac{1}{4}$ "- $\frac{1}{2}$ " outside the design.

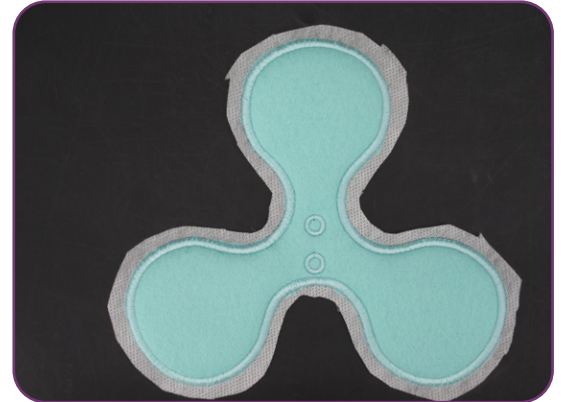

Step 23

- Place petals onto cutting mat. Using the 3mm attachment with the punch tool, punch holes in the eyelets. Refer to the punch tool guides on page 26-28 for hole placement.

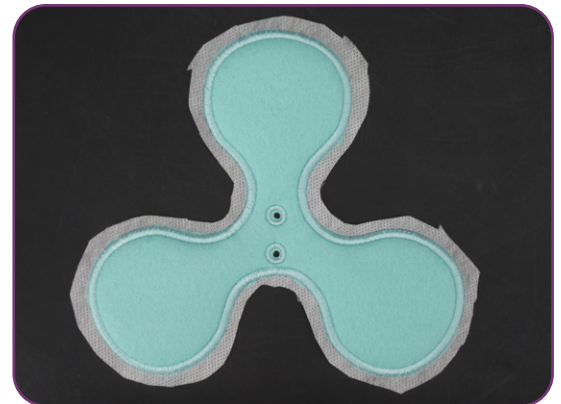

Step 24

- Pull remaining BadgeMaster away from design.
- Rinse each piece completely in warm running water until all trace of the stabilizer is dissolved.
- Lay face down on a non-stick surface to dry. Parchment paper or a cooling rack work well. This prevents the piece from curling.

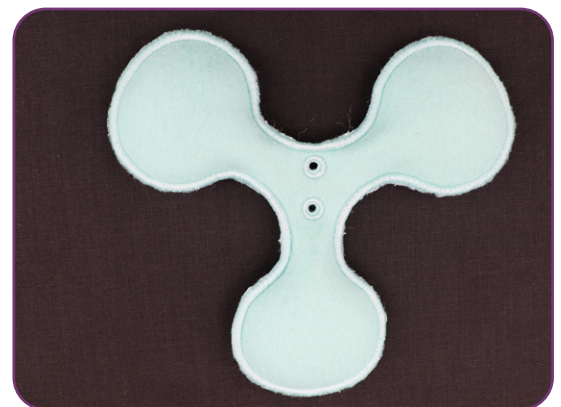

LEAVES



Step 25

- To create the leaves, hoop one layer of OESD Aquamesh and one layer of OESD BadgeMaster. Follow steps 19 -24 in the instructions.

ASSEMBLY



Step 1

- Using OESD Alligator clamps, stuff petals and stamen with poly-fil to desired thickness.
- Note: A chopstick or 12-inch $\frac{1}{4}$ round dowel can be used to fill with poly-fil. If you would prefer to use walnut shells or your favorite pin cushion stuffing instead of poly-fil, use a hand sewing needle to close the opening after filling.



Step 2

- Using Alligator Clamps, pull ribbon through the ribbon holes of the stamen.

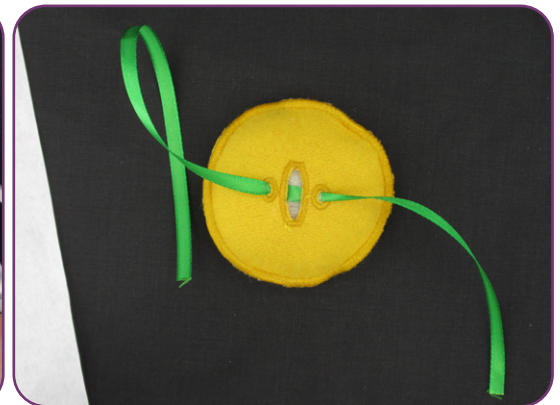
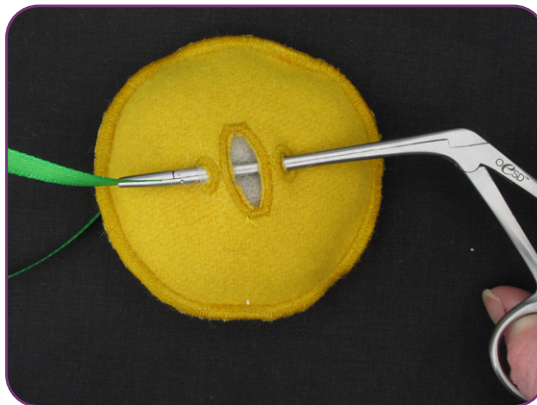

ASSEMBLY



Step 3

- Align ribbon holes of 1 leaf and both petals. Using alligator clamps pull ribbon through ribbon holes.

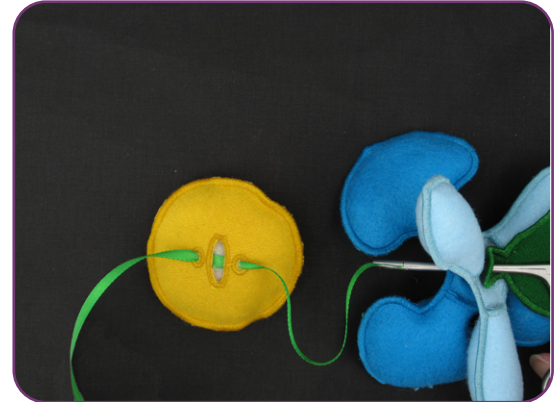

Step 4

- Align ribbon holes of 2nd leaf and both petals. Using alligator clamps pull ribbon through ribbon holes.

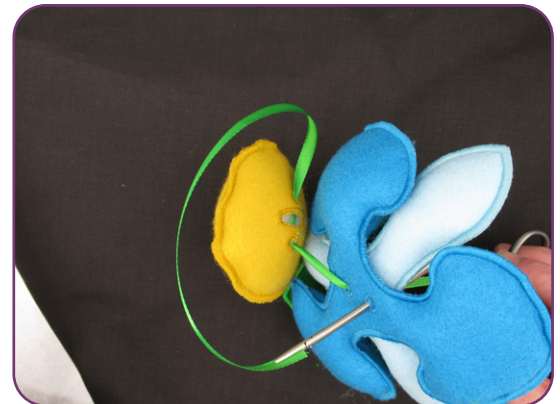

Step 5

- Pull ribbon ends until ribbon is even on both sides. Arrange leaves to desired position.



ASSEMBLY



Step 6

- Tie ribbon into bow and trim ends to shorten.

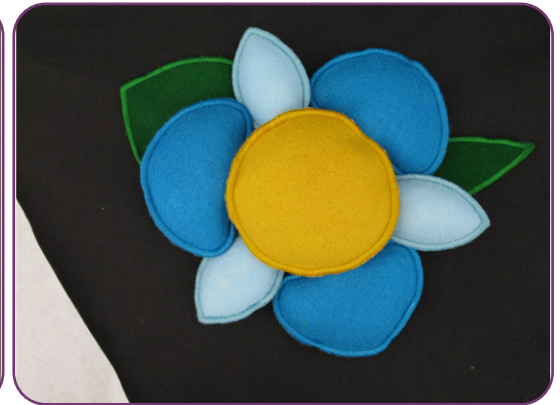
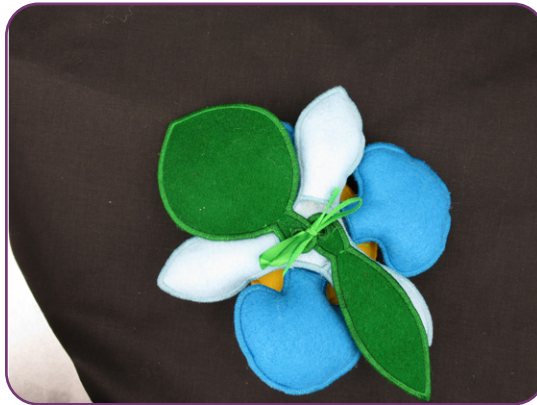

PUNCH TOOL GUIDES



51254-01

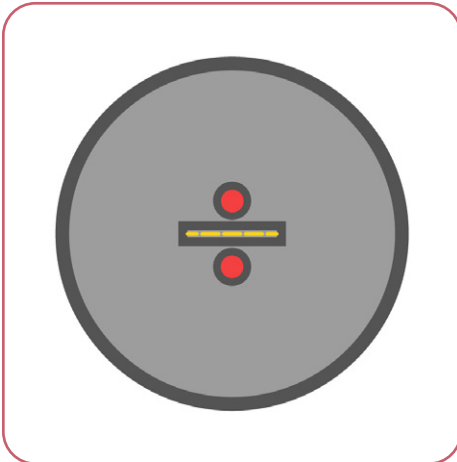

51254-02

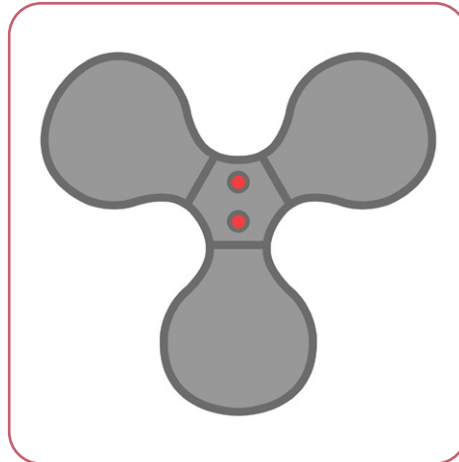

51254-03

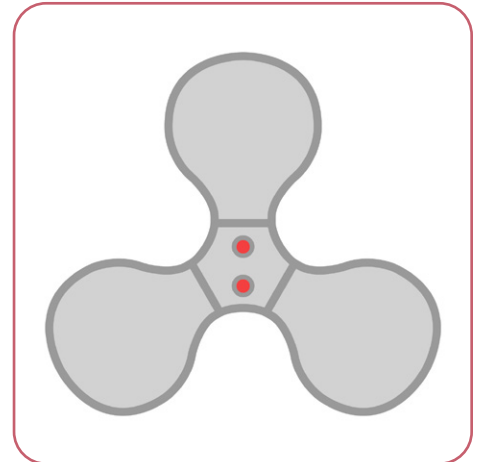

51254-04

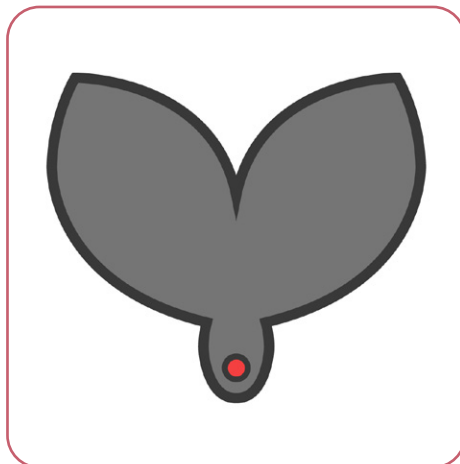

51254-05

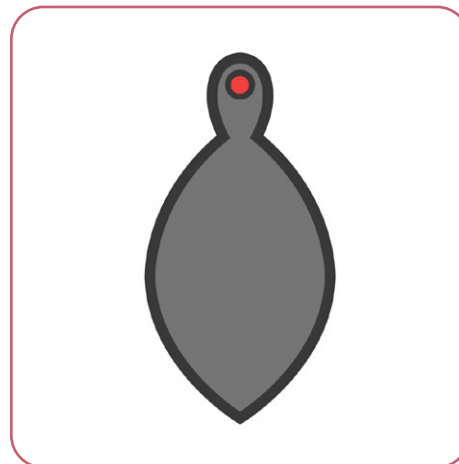

● = 2 MM

● = 3 MM

● = 4 MM

CRAFT KNIFE



PUNCH TOOL GUIDES



51254-06

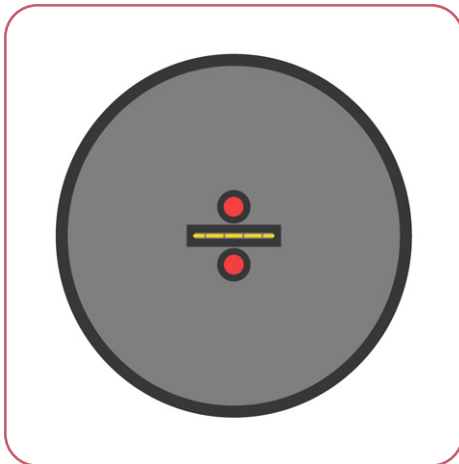

51254-07

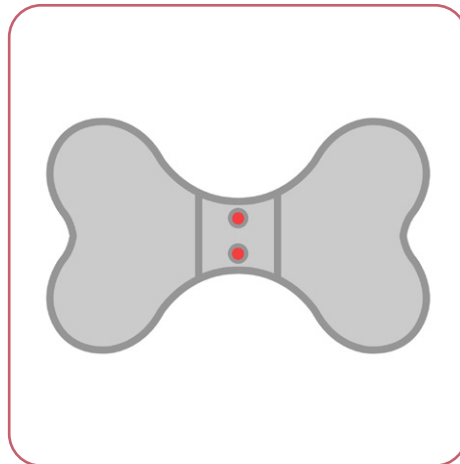

51254-08

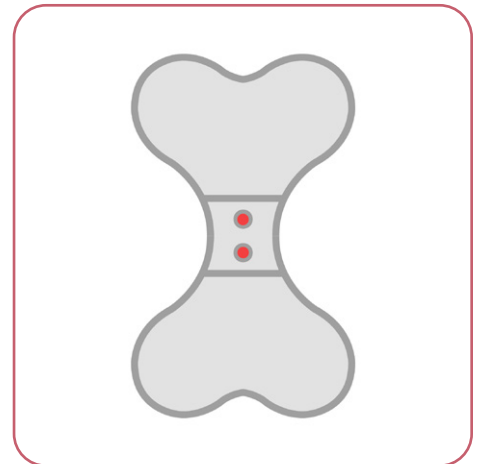

51254-09

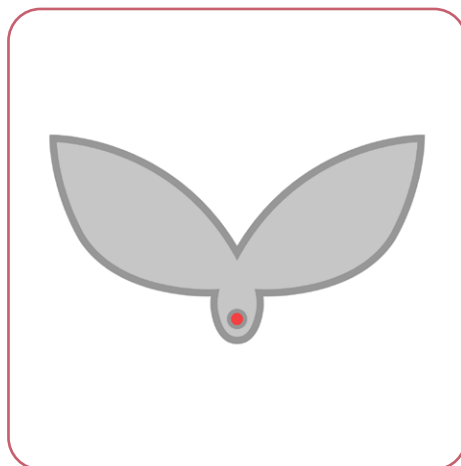

51254-10

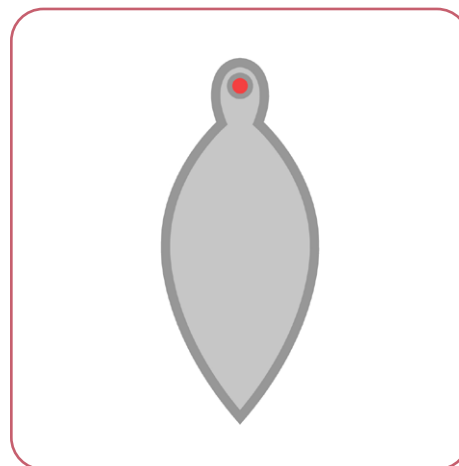

-  = 2 MM
-  = 3 MM
-  = 4 MM

CRAFT KNIFE



PUNCH TOOL GUIDES



51254-11

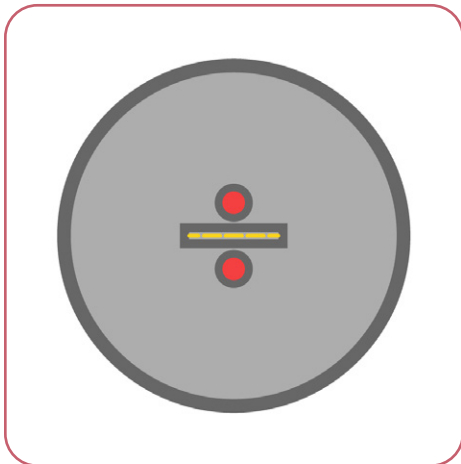

51254-12

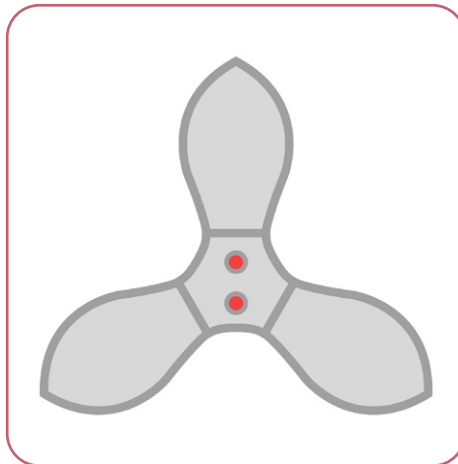

51254-13

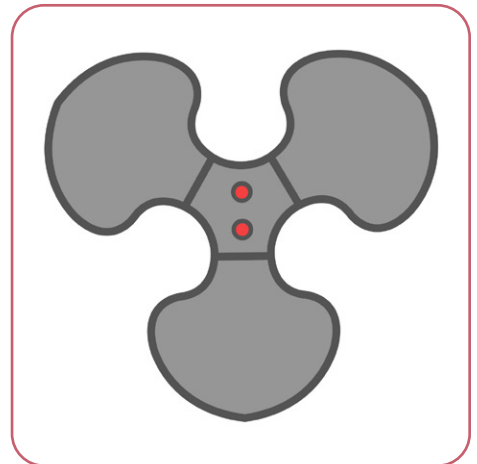

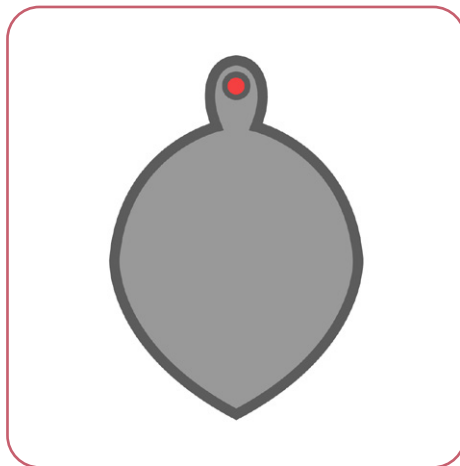

51254-14

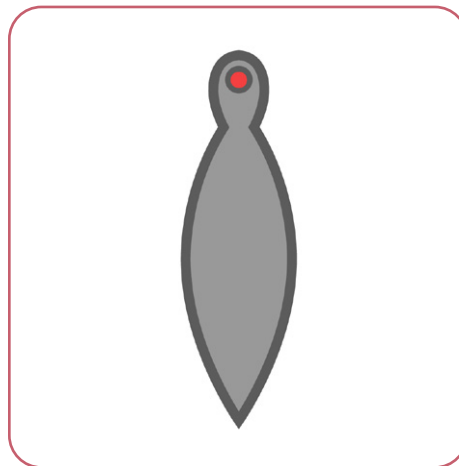

51254-15



 = 2 MM

 = 3 MM

 = 4 MM

CRAFT KNIFE



PRINTING INSTRUCTIONS



ATTENTION

When printing this document, any page scaling or page fitting options in your print dialog box must be turned OFF or set to NONE so that your files will print out at their actual size. Images not printed at actual size will not function as intended.

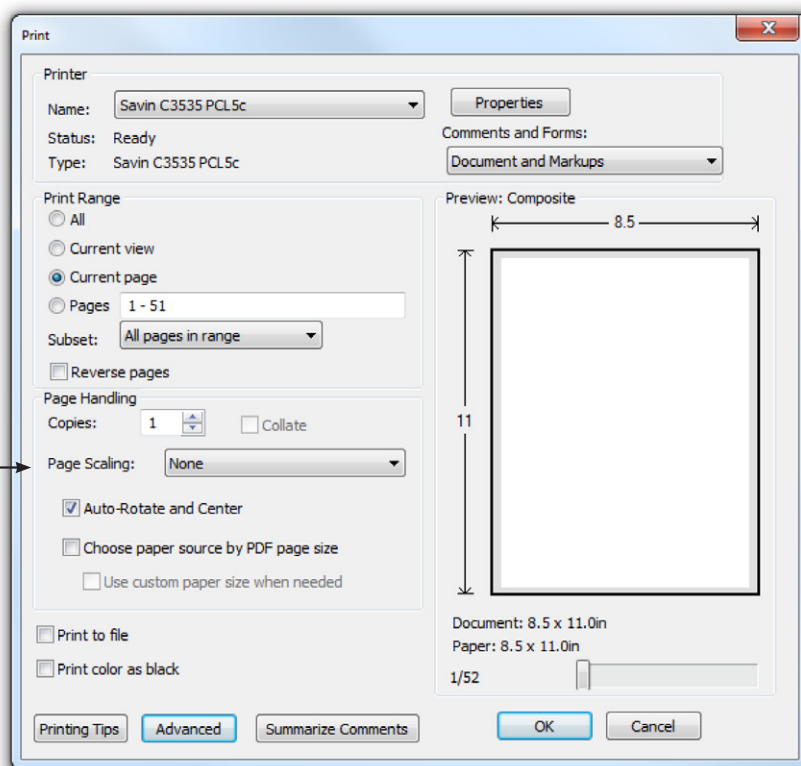

TO SAVE PAPER

Only print the desired image by navigating to the image's page, go to File > Print and select "Current page" in the print dialog box. Repeat for each desired image.

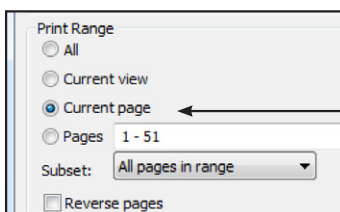

APPLIQUE PATTERNS



Print at 100%. No scaling. This box measures 1" x 1". Use the box as an accuracy guide when printing templates.

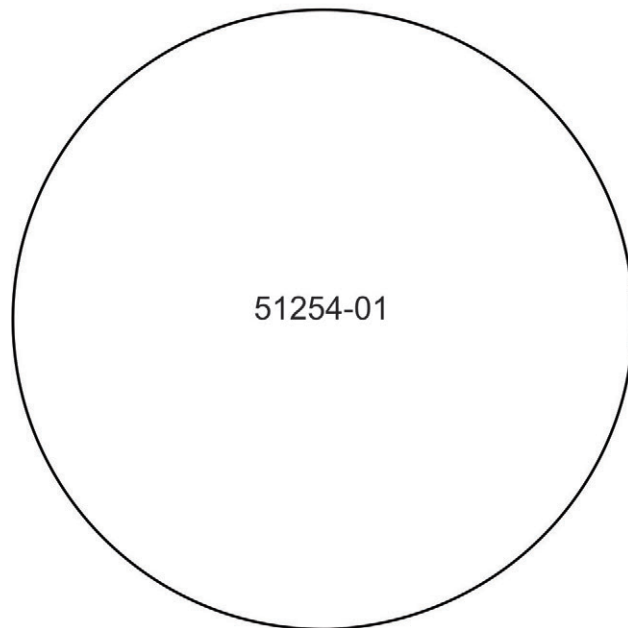
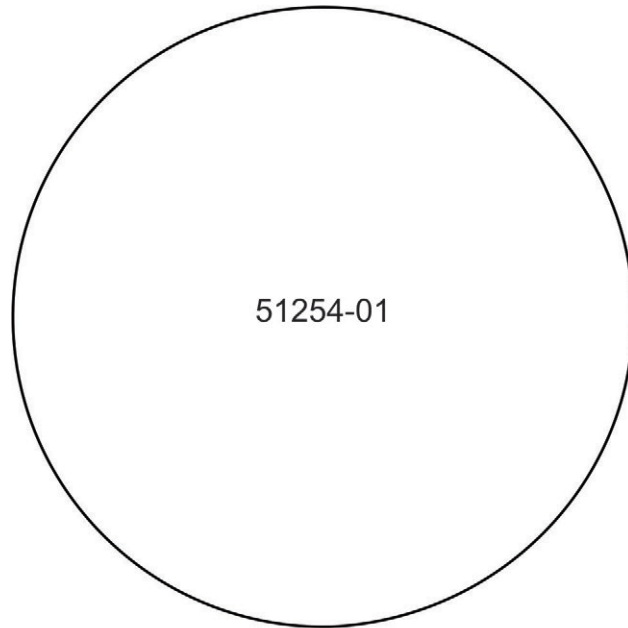

APPLIQUE PATTERNS



Print at 100%. No scaling. This box measures 1" x 1". Use the box as an accuracy guide when printing templates.

51254-02

51254-02

51254-02

51254-02

APPLIQUE PATTERNS

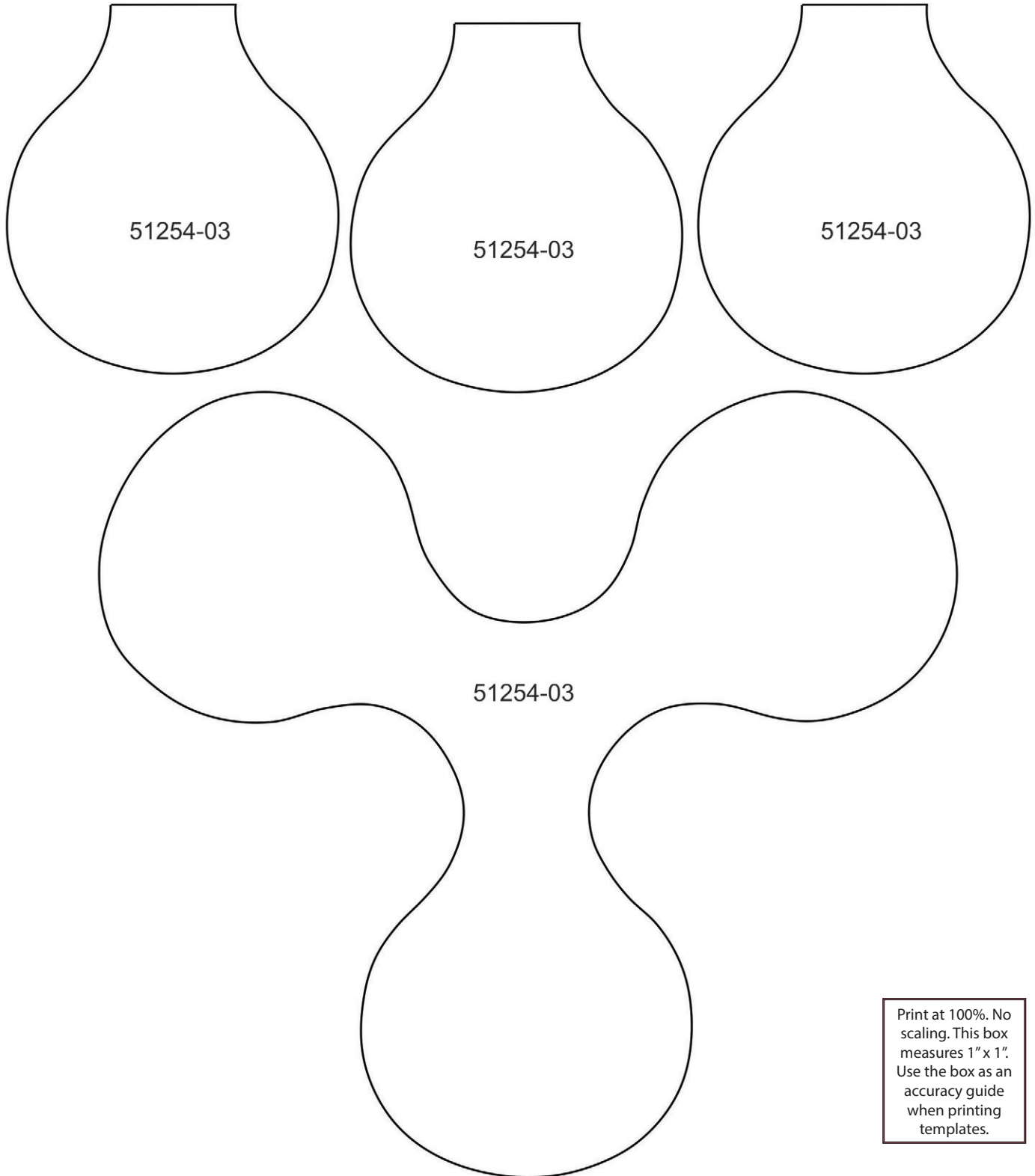

Print at 100%. No scaling. This box measures 1" x 1". Use the box as an accuracy guide when printing templates.

APPLIQUE PATTERNS



Print at 100%. No scaling. This box measures 1" x 1". Use the box as an accuracy guide when printing templates.

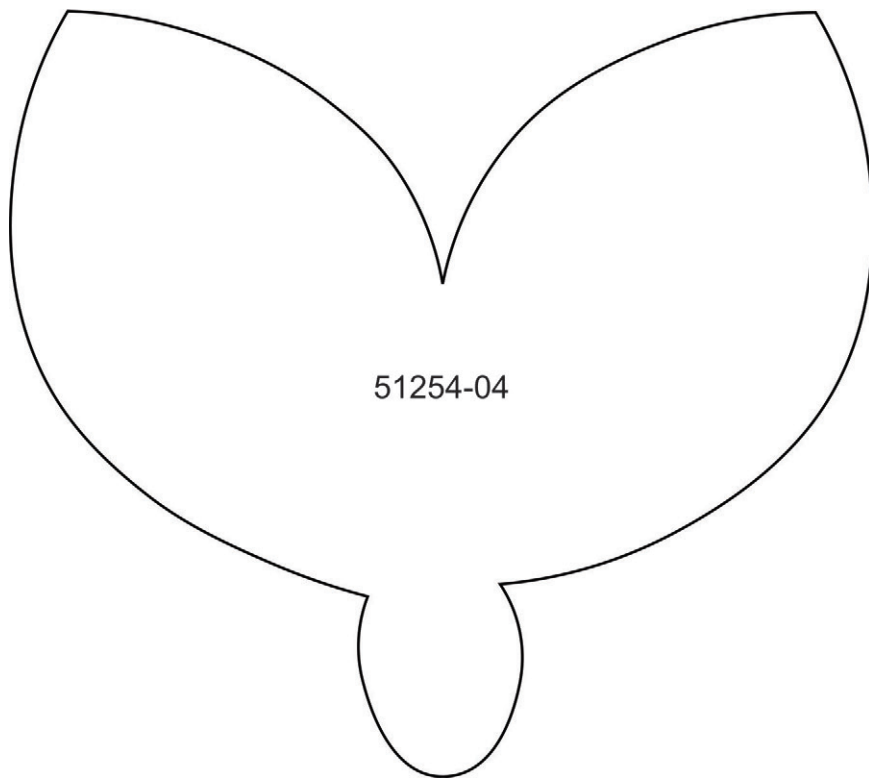

51254-04

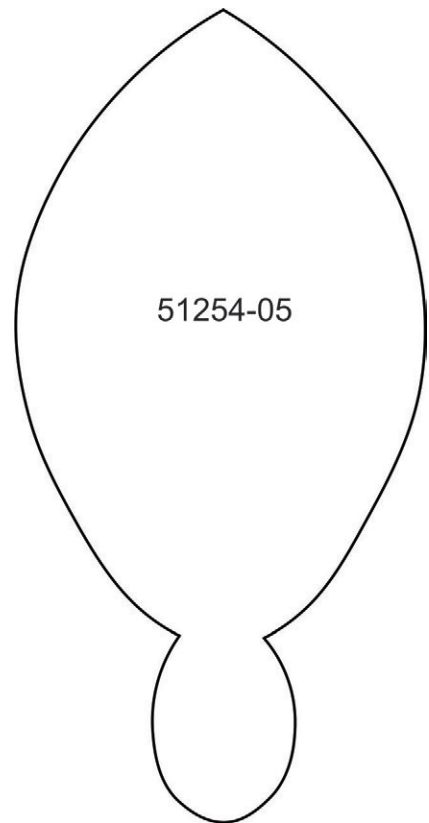

51254-05

APPLIQUE PATTERNS



Print at 100%. No scaling. This box measures 1" x 1". Use the box as an accuracy guide when printing templates.

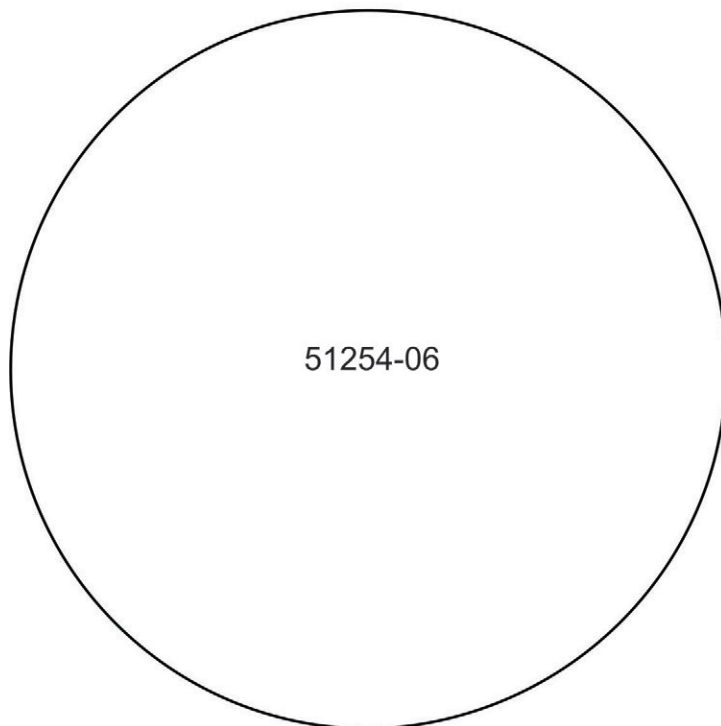
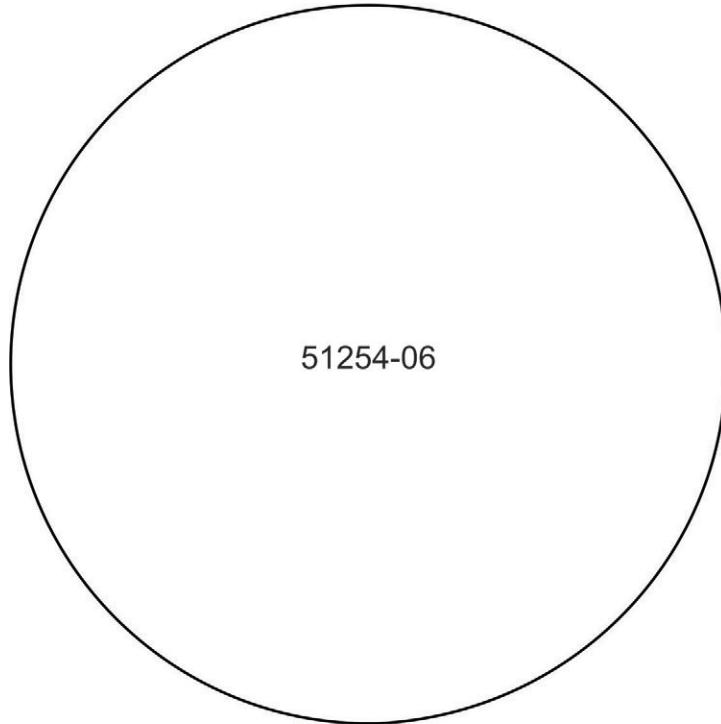

APPLIQUE PATTERNS



Print at 100%. No scaling. This box measures 1" x 1". Use the box as an accuracy guide when printing templates.

51254-07

51254-07

51254-07

APPLIQUE PATTERNS



Print at 100%. No scaling. This box measures 1" x 1". Use the box as an accuracy guide when printing templates.

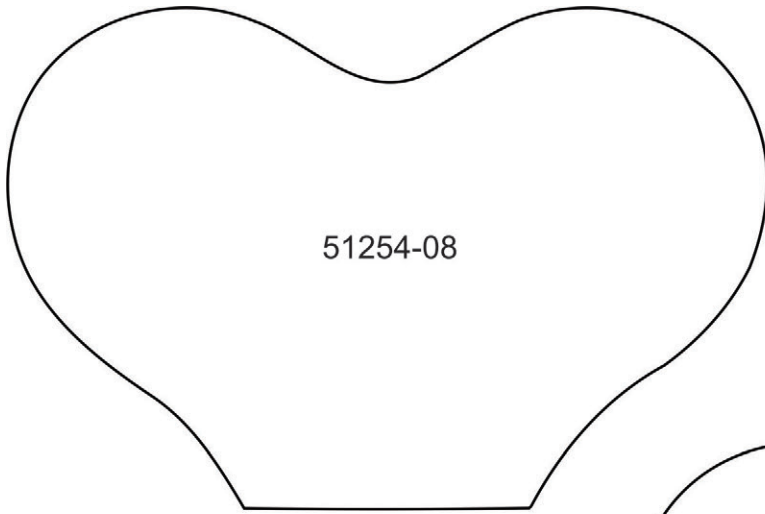

51254-08

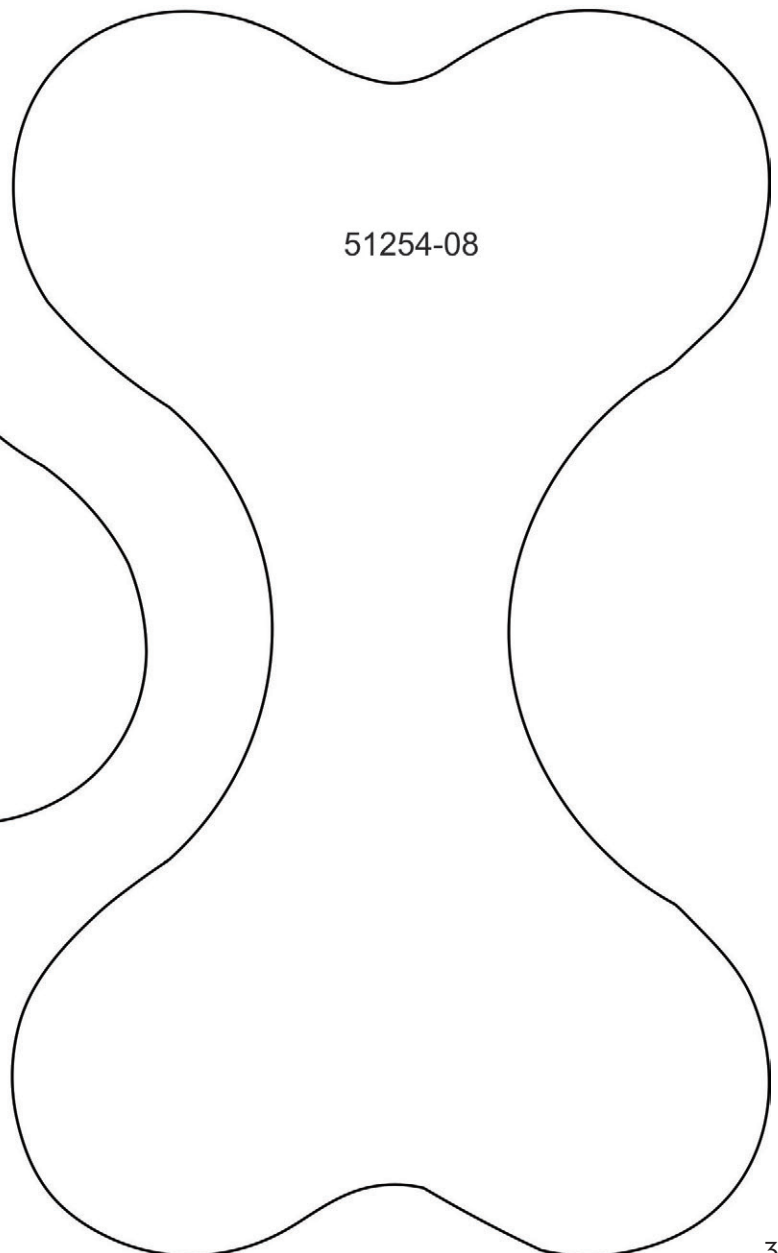

51254-08

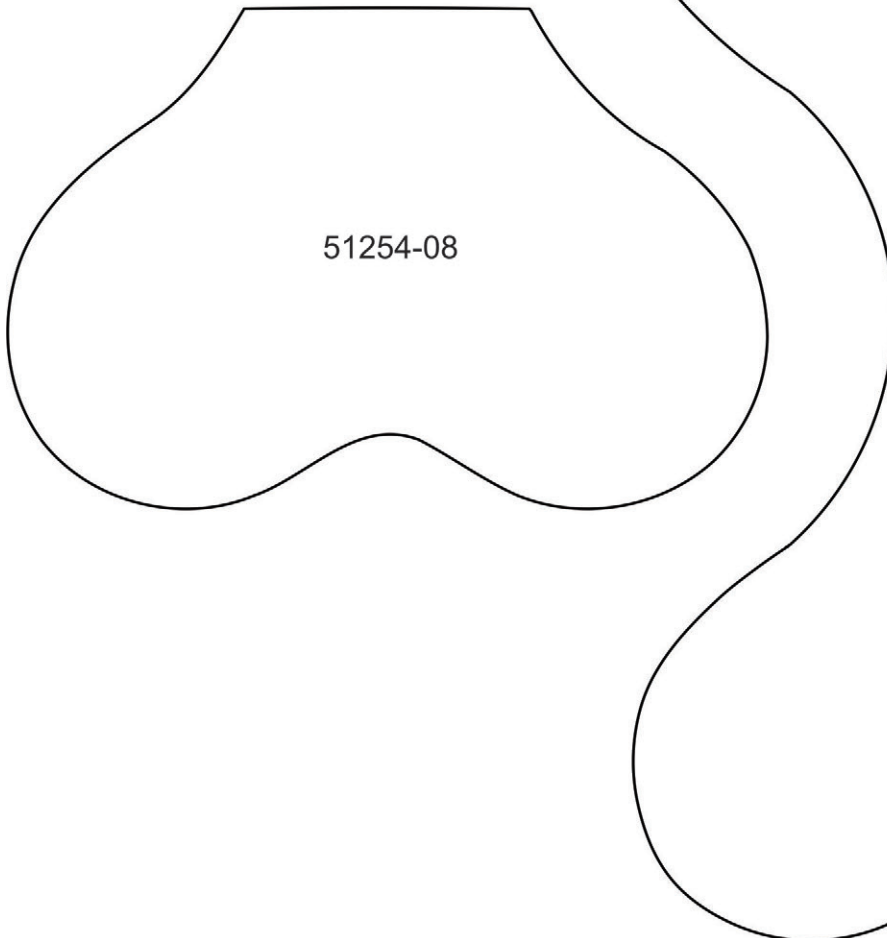

51254-08

APPLIQUE PATTERNS



Print at 100%. No scaling. This box measures 1" x 1". Use the box as an accuracy guide when printing templates.

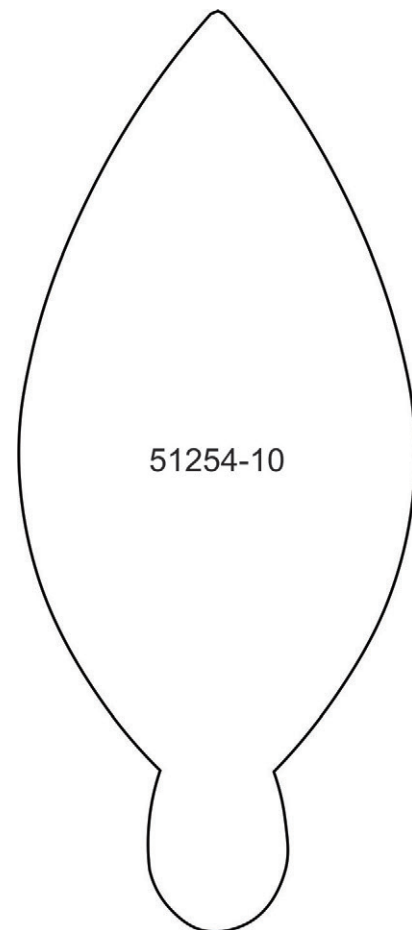
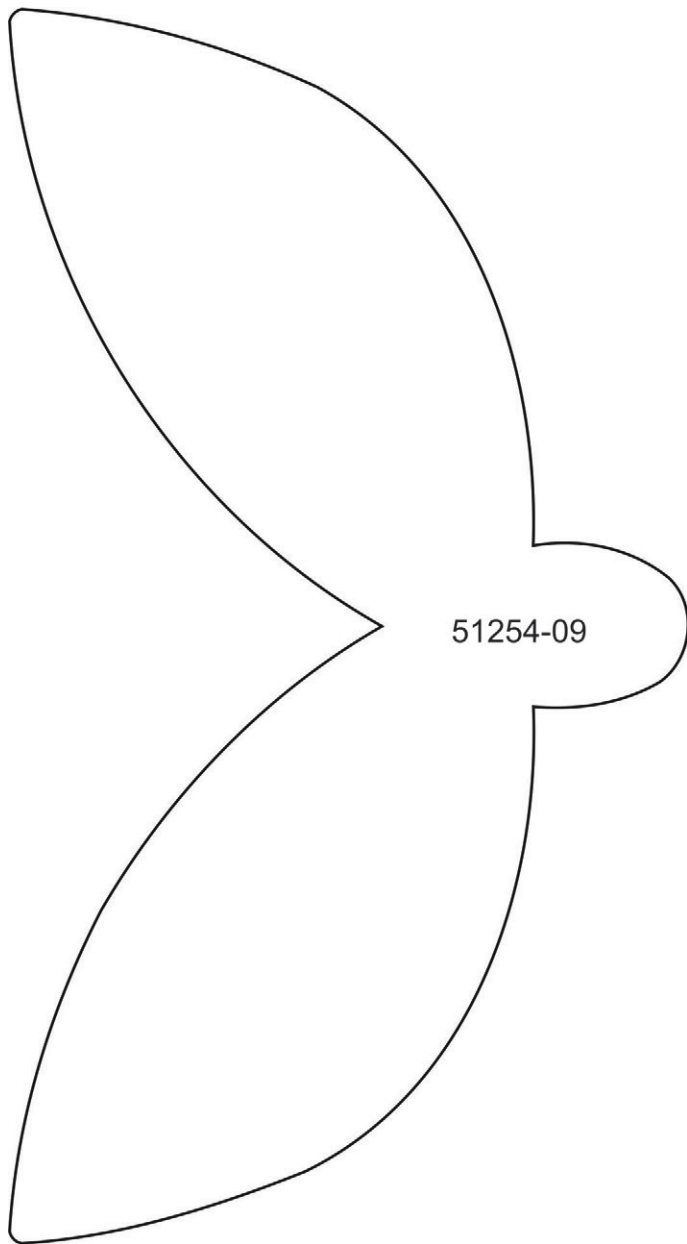

APPLIQUE PATTERNS



Print at 100%. No scaling. This box measures 1" x 1". Use the box as an accuracy guide when printing templates.

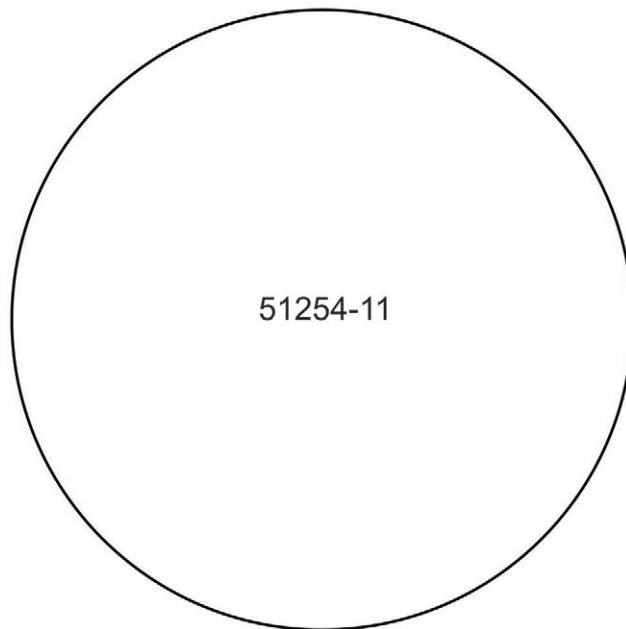
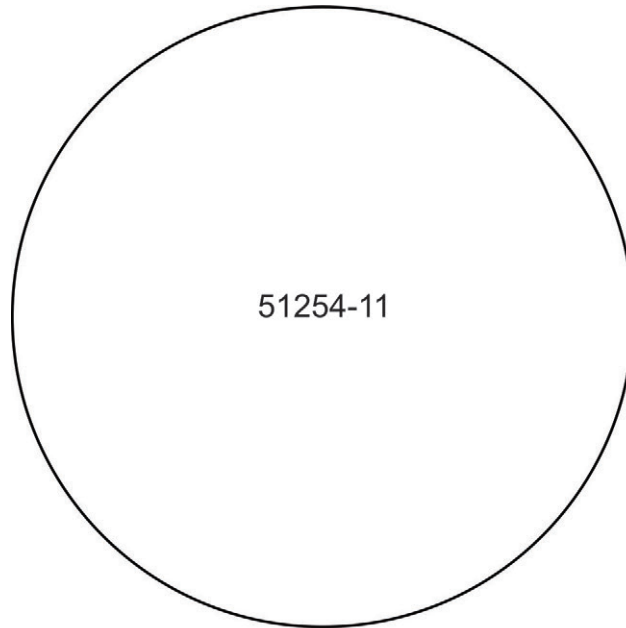

APPLIQUE PATTERNS



Print at 100%. No scaling. This box measures 1" x 1". Use the box as an accuracy guide when printing templates.

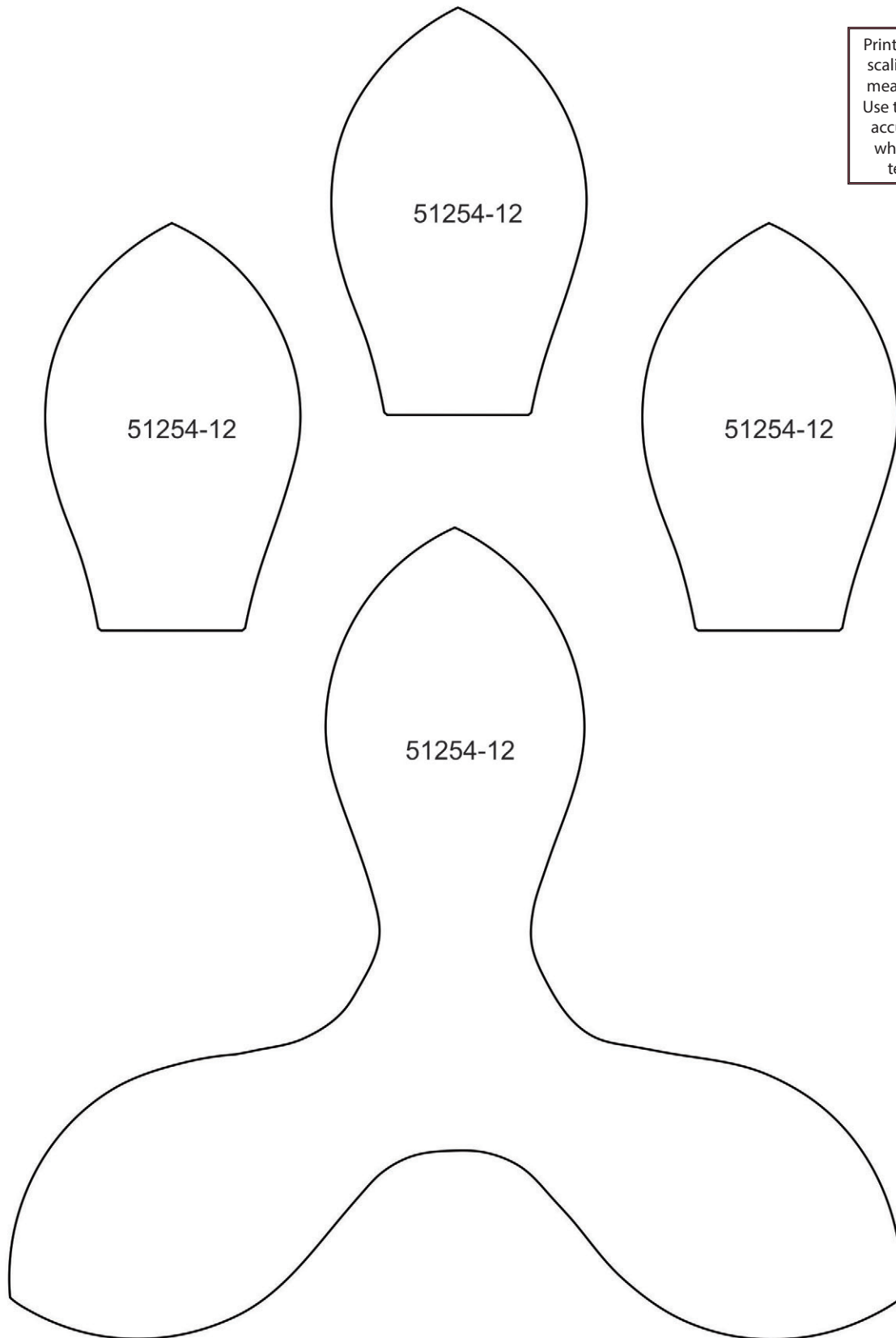

APPLIQUE PATTERNS



Print at 100%. No scaling. This box measures 1" x 1". Use the box as an accuracy guide when printing templates.

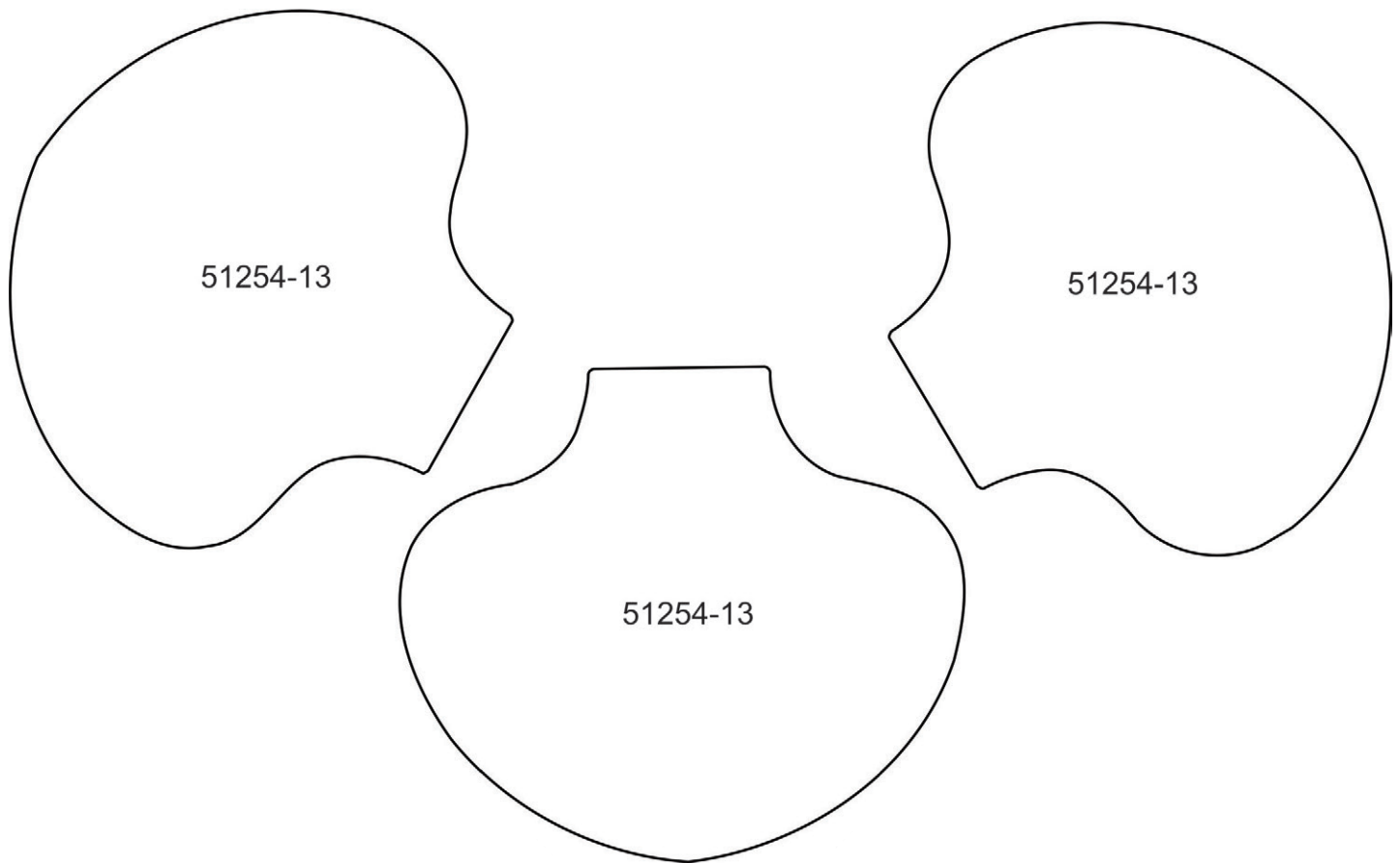

APPLIQUE PATTERNS



Print at 100%. No scaling. This box measures 1" x 1". Use the box as an accuracy guide when printing templates.

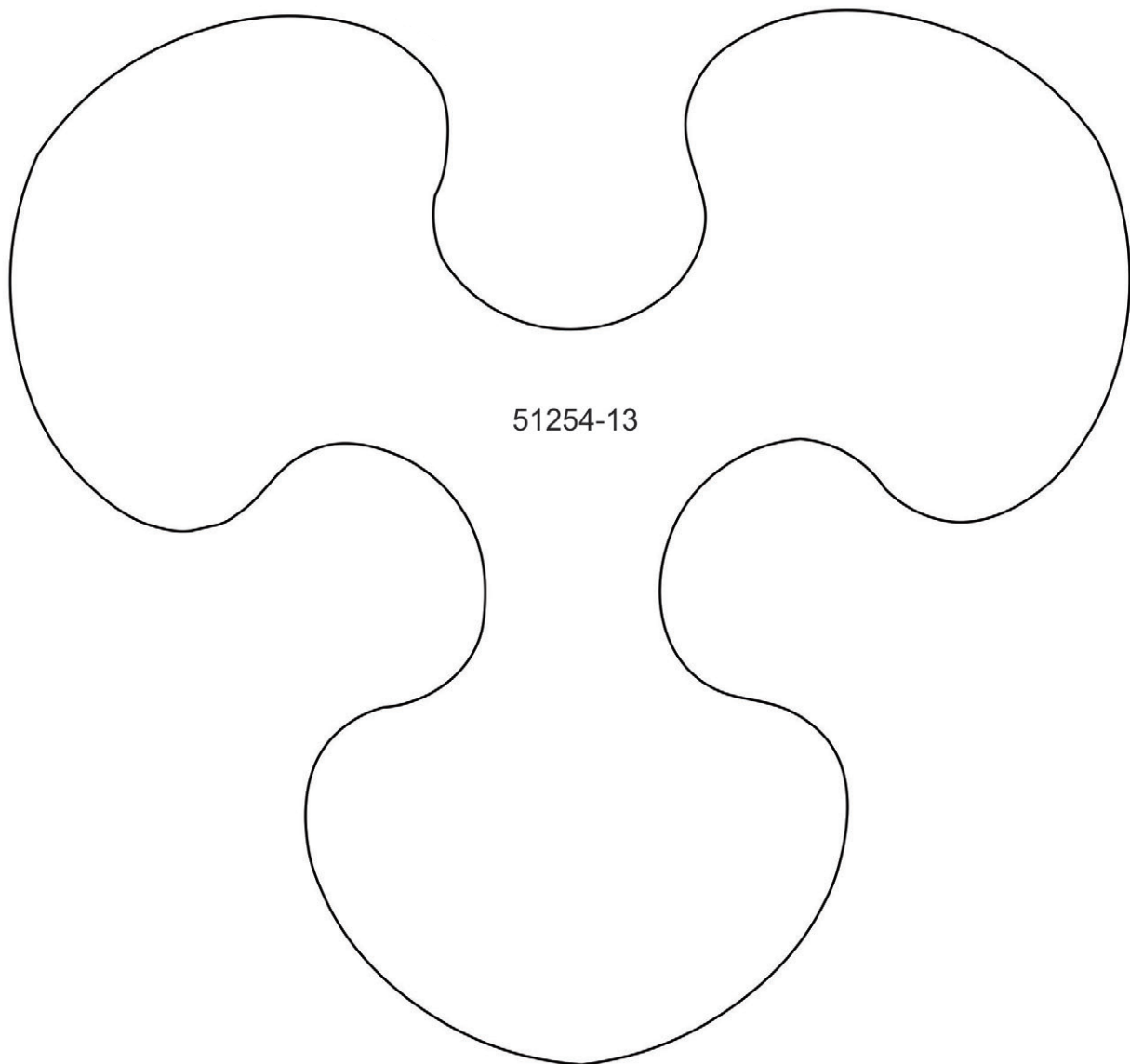

51254-13

APPLIQUE PATTERNS



Print at 100%. No scaling. This box measures 1" x 1". Use the box as an accuracy guide when printing templates.

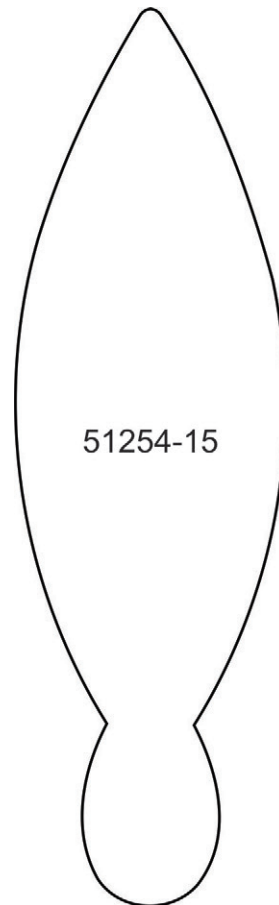
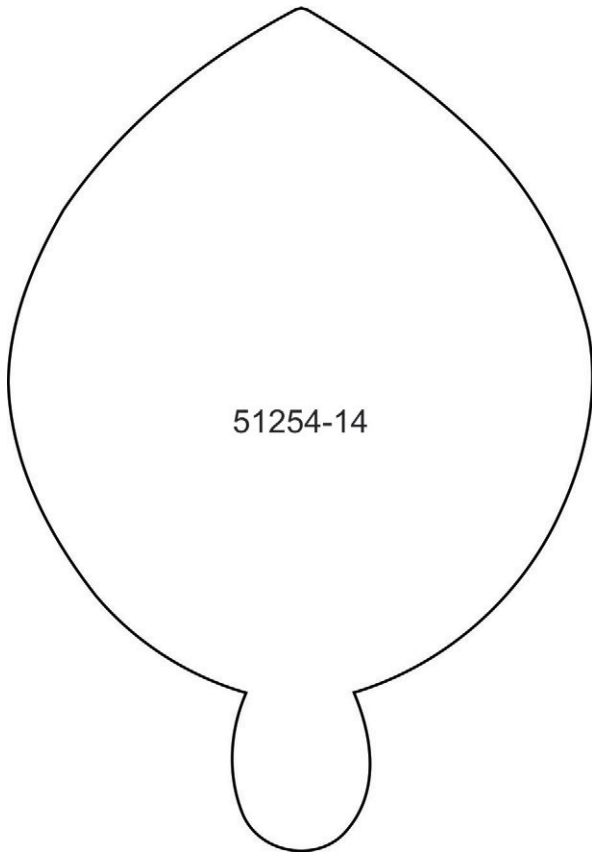

MIRRORED PATTERNS



Print at 100%. No scaling. This box measures 1" x 1". Use the box as an accuracy guide when printing templates.

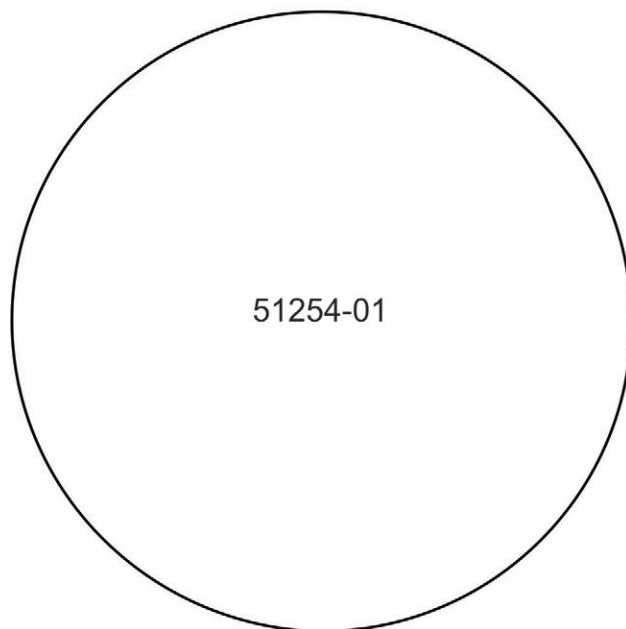
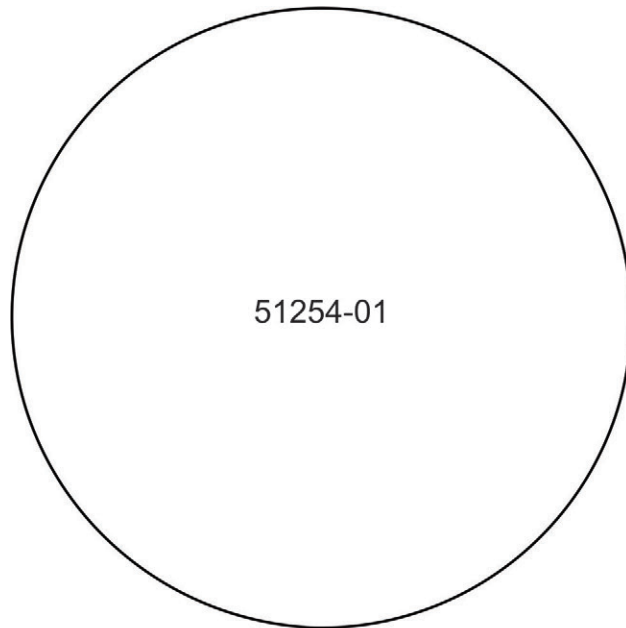

MIRRORED PATTERNS



Print at 100%. No scaling. This box measures 1" x 1". Use the box as an accuracy guide when printing templates.

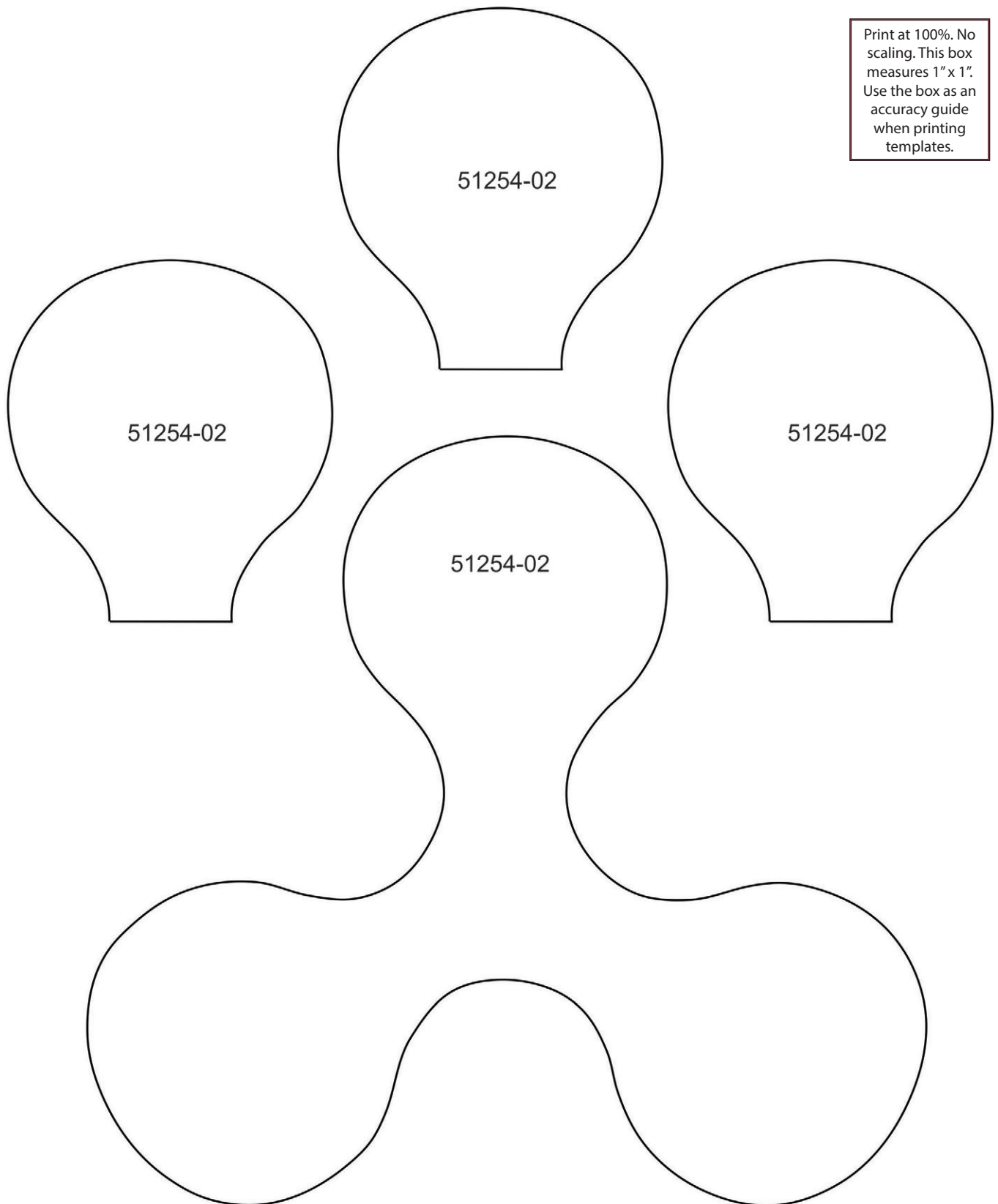

MIRRORED PATTERNS

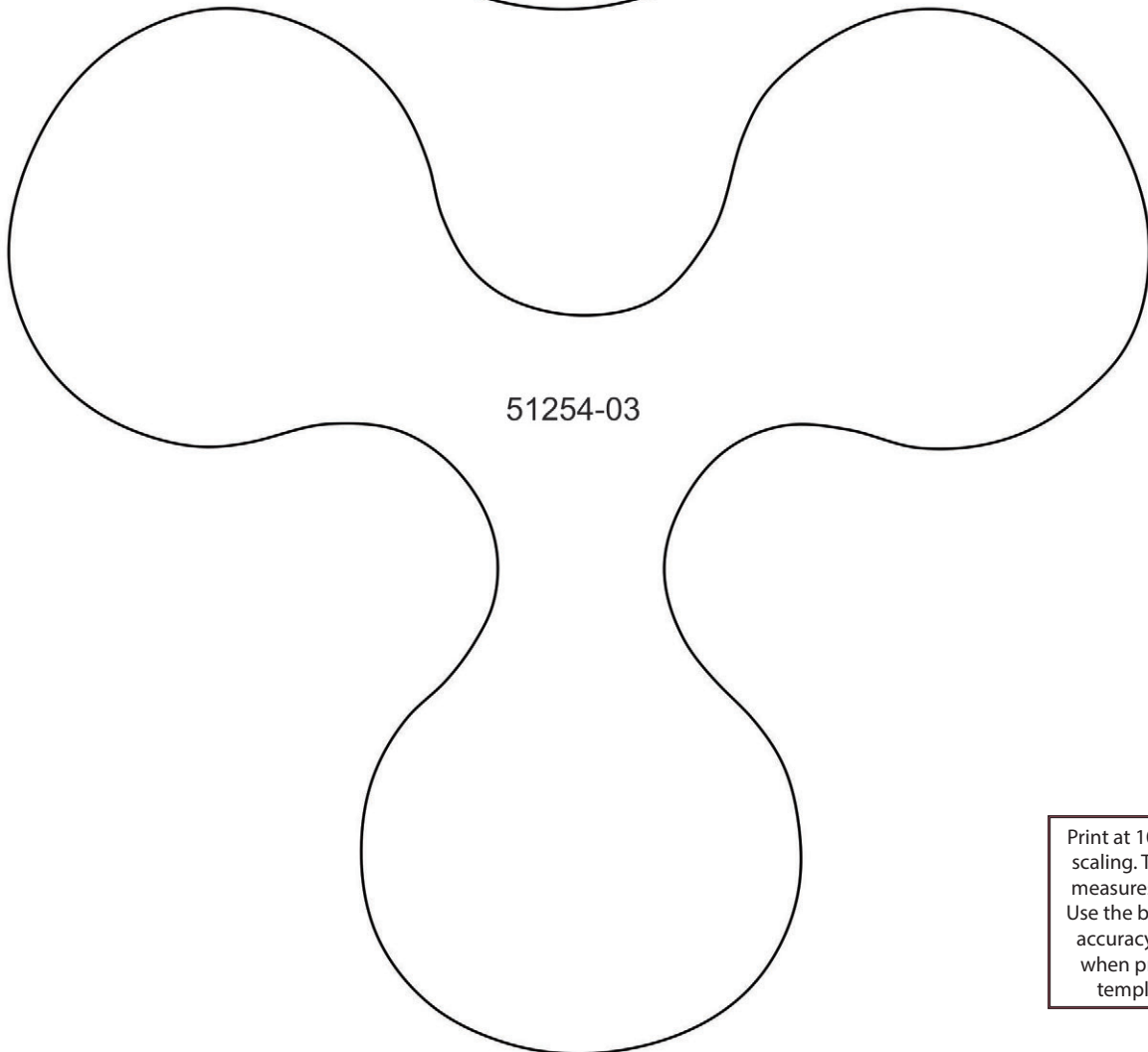
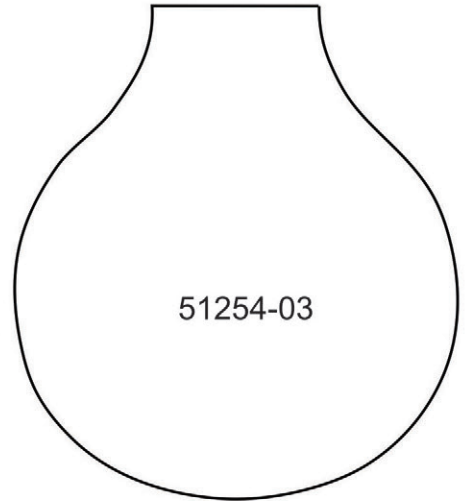
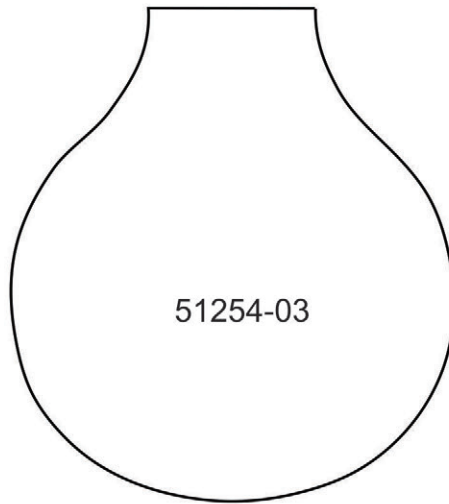
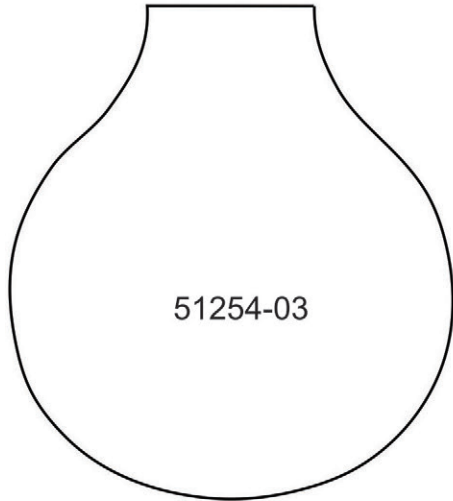

Print at 100%. No scaling. This box measures 1" x 1". Use the box as an accuracy guide when printing templates.

MIRRORED PATTERNS



Print at 100%. No scaling. This box measures 1" x 1". Use the box as an accuracy guide when printing templates.

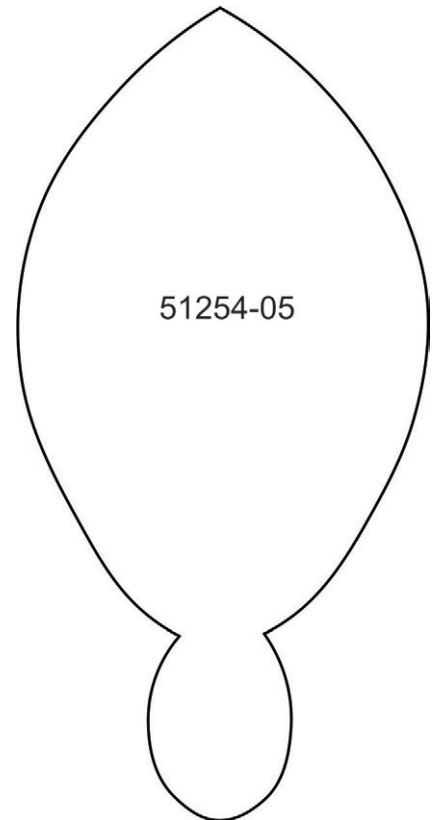
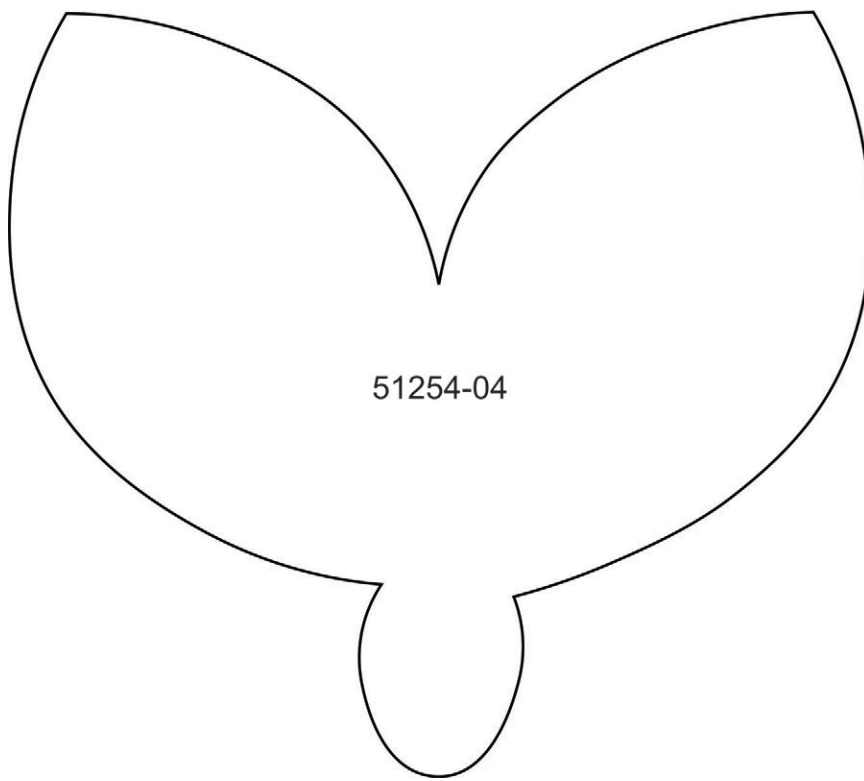

MIRRORED PATTERNS



Print at 100%. No scaling. This box measures 1" x 1". Use the box as an accuracy guide when printing templates.

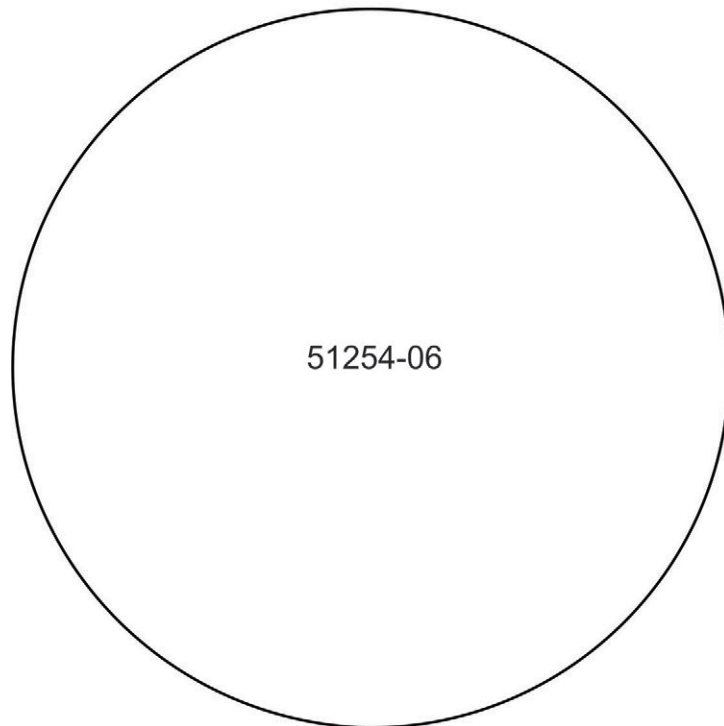
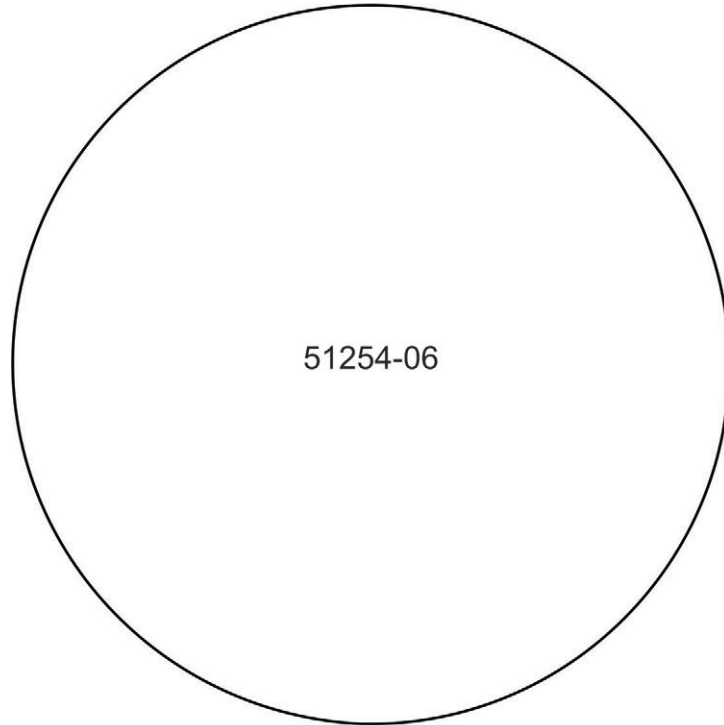

MIRRORED PATTERNS



Print at 100%. No scaling. This box measures 1" x 1". Use the box as an accuracy guide when printing templates.

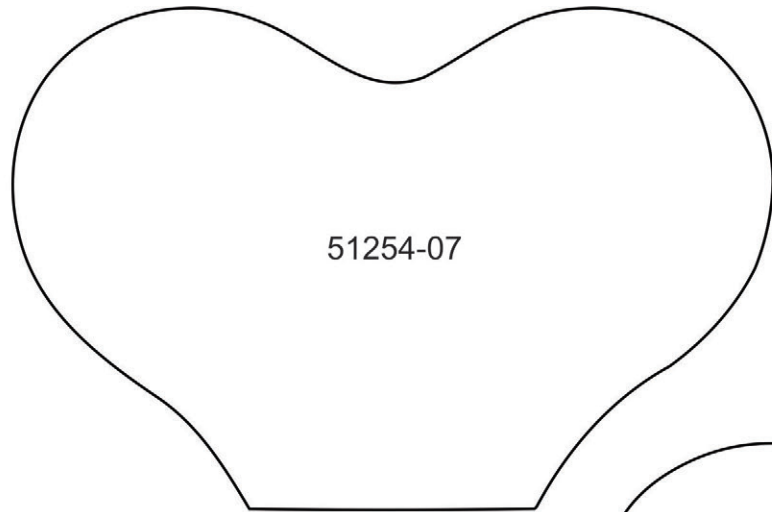

51254-07

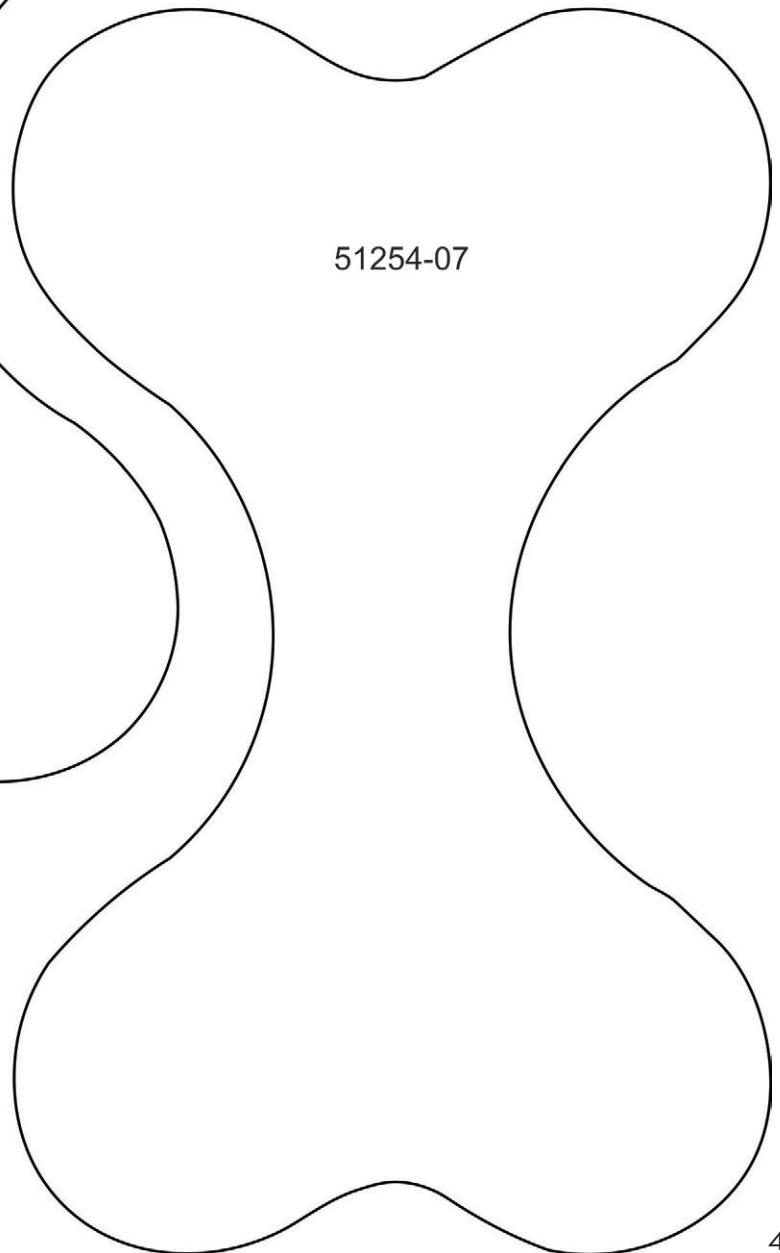

51254-07

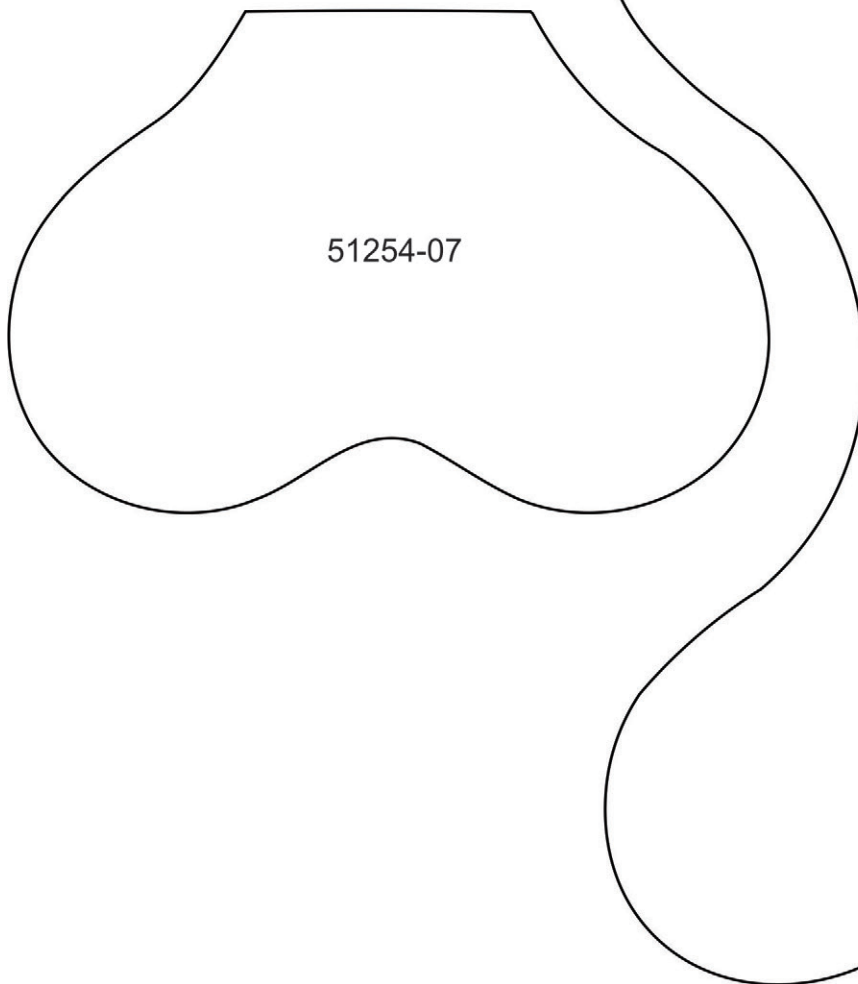

51254-07

MIRRORED PATTERNS



Print at 100%. No scaling. This box measures 1" x 1". Use the box as an accuracy guide when printing templates.

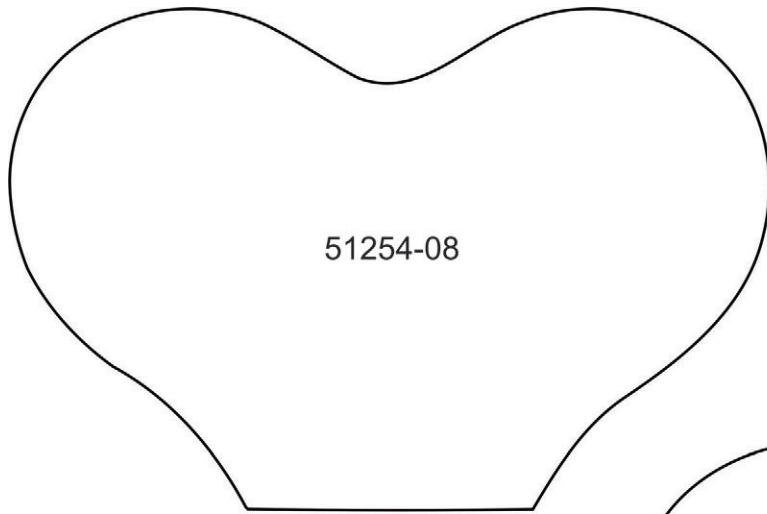

51254-08

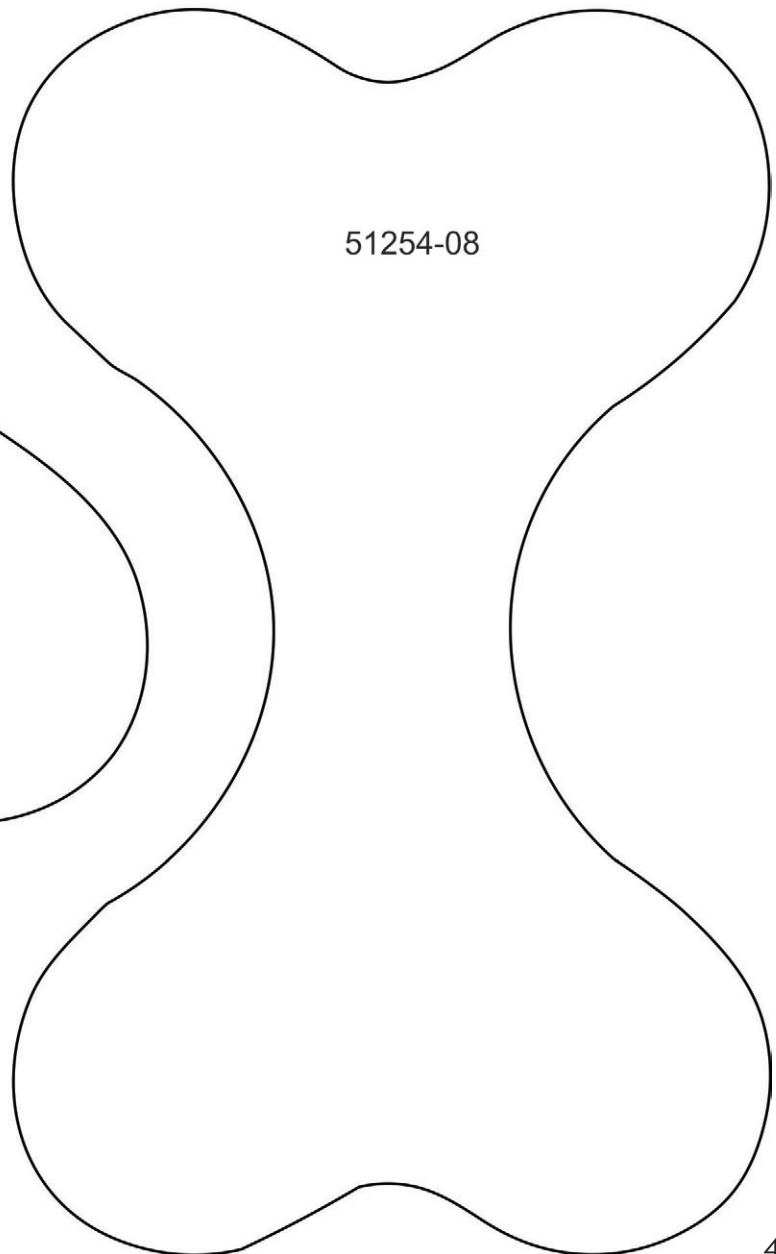

51254-08

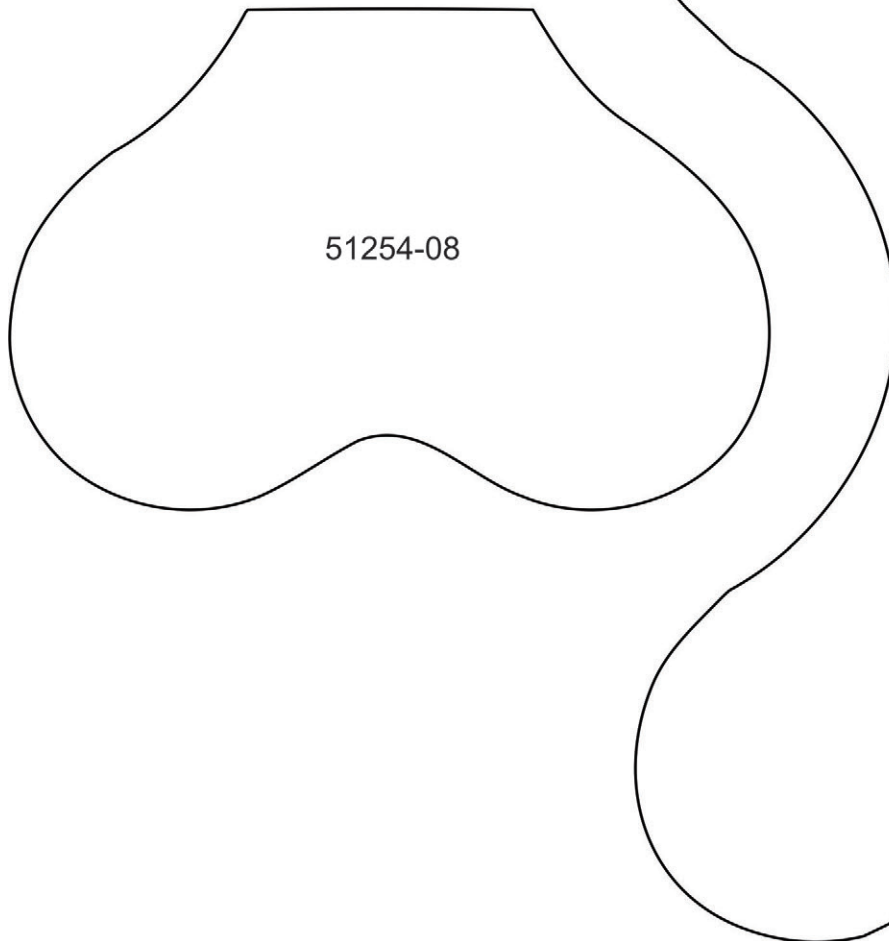

51254-08

MIRRORED PATTERNS



Print at 100%. No scaling. This box measures 1" x 1". Use the box as an accuracy guide when printing templates.

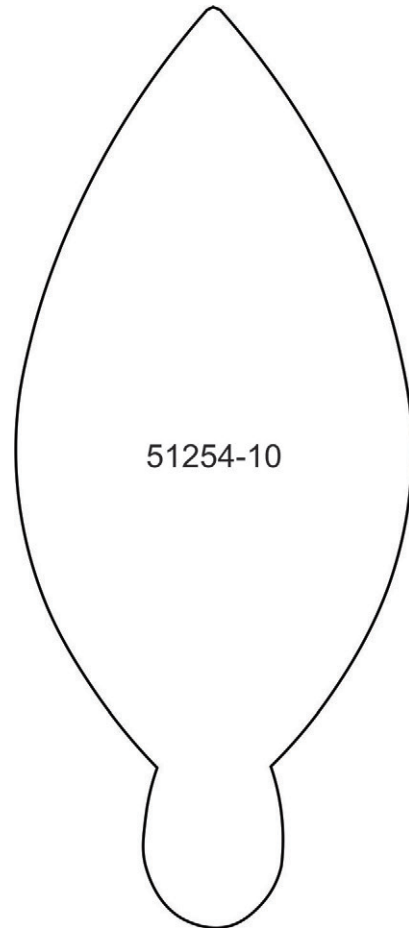
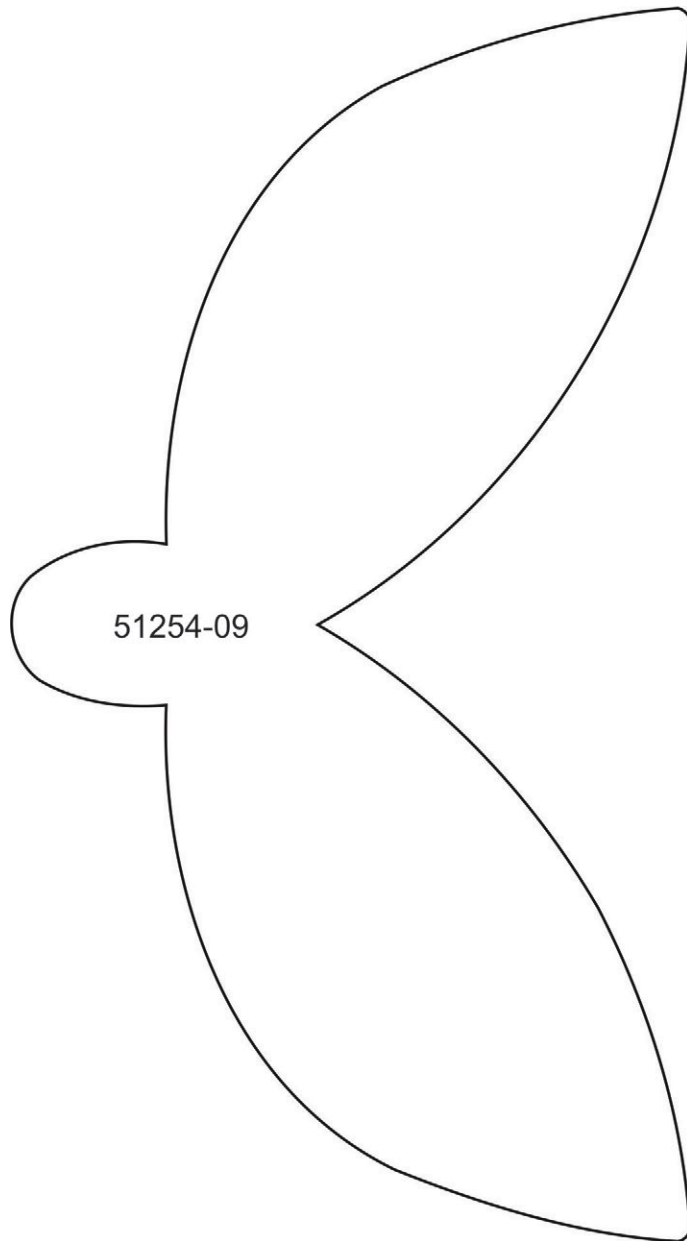

MIRRORED PATTERNS



Print at 100%. No scaling. This box measures 1" x 1". Use the box as an accuracy guide when printing templates.

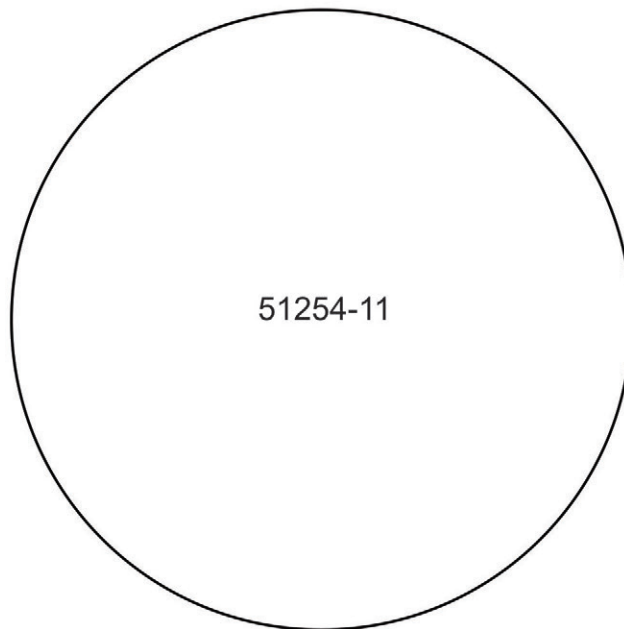
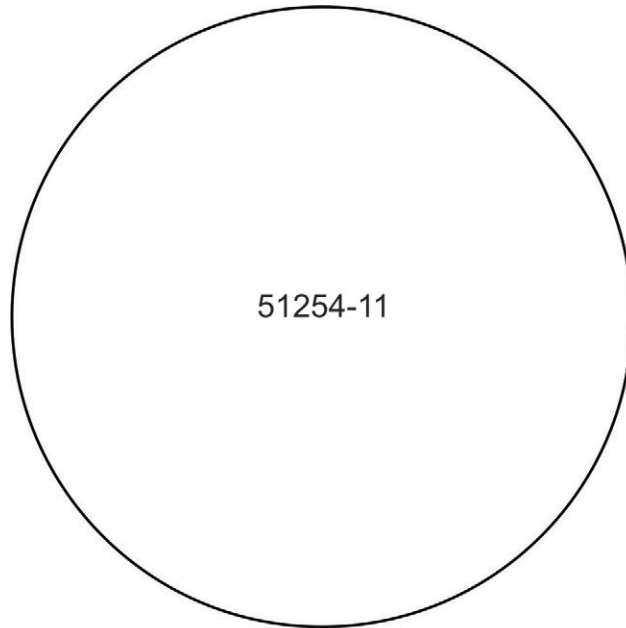

MIRRORED PATTERNS



Print at 100%. No scaling. This box measures 1" x 1". Use the box as an accuracy guide when printing templates.

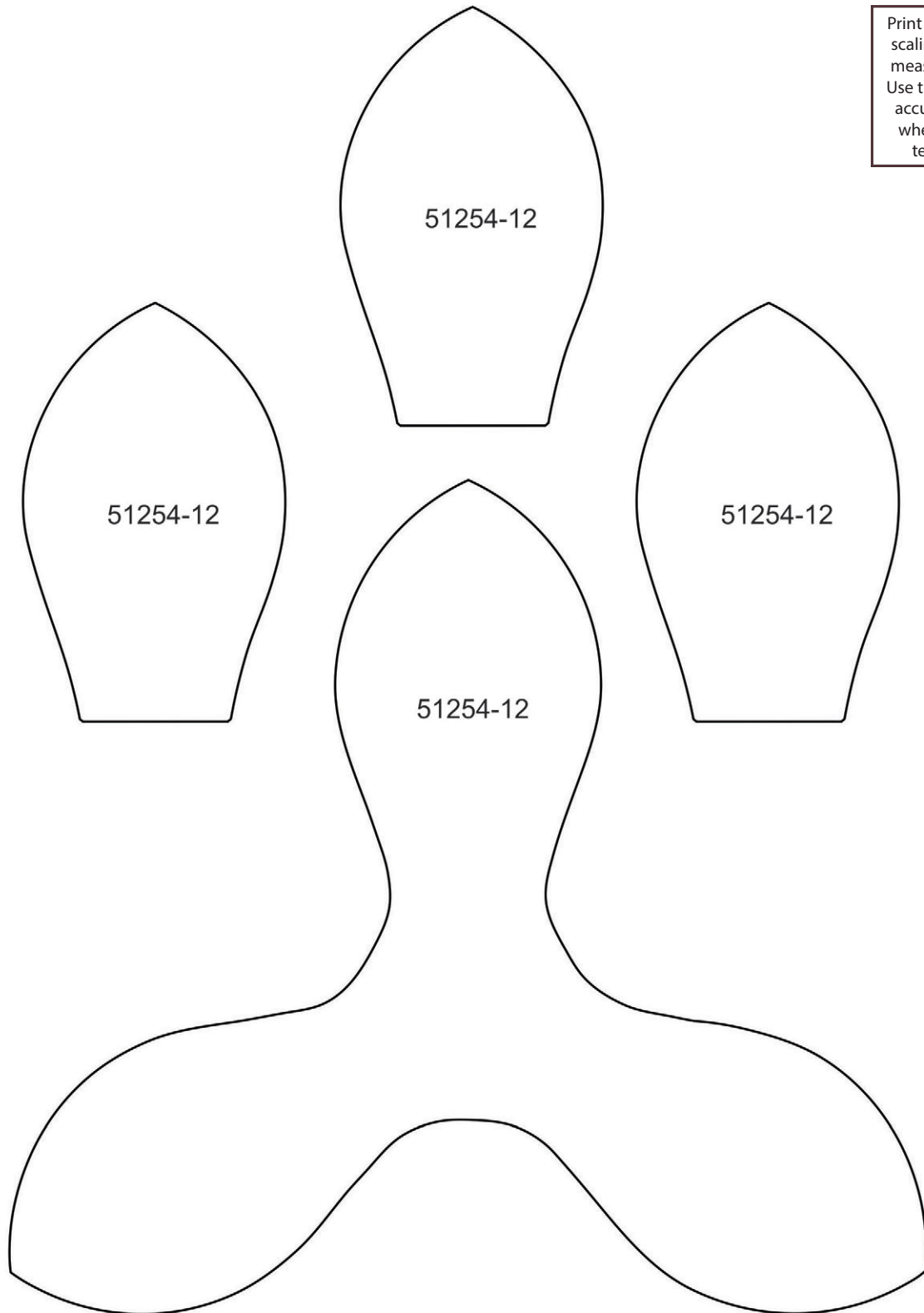

MIRRORED PATTERNS



Print at 100%. No scaling. This box measures 1" x 1". Use the box as an accuracy guide when printing templates.

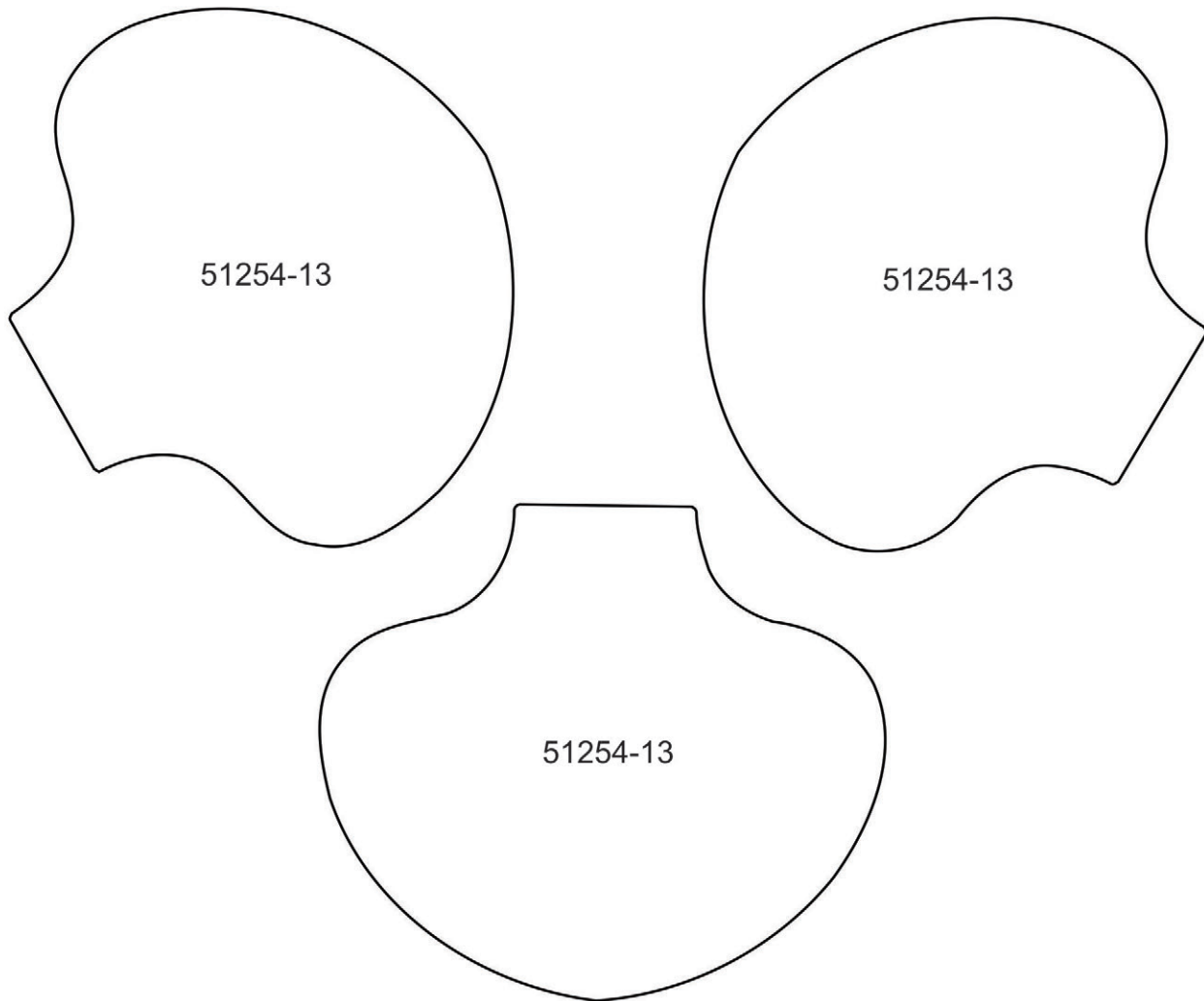

MIRRORED PATTERNS



Print at 100%. No scaling. This box measures 1" x 1". Use the box as an accuracy guide when printing templates.

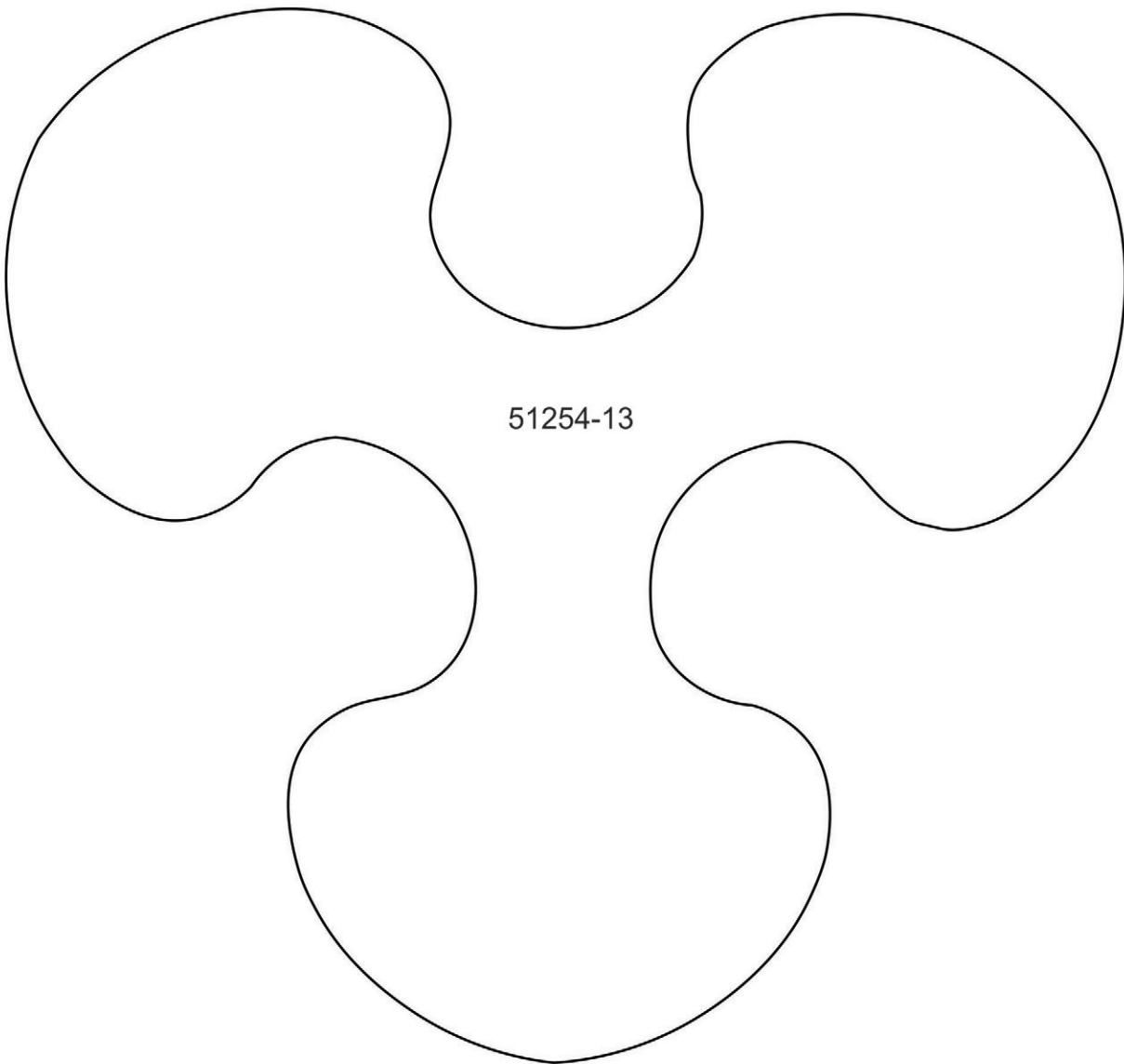

51254-13

MIRRORED PATTERNS



Print at 100%. No scaling. This box measures 1" x 1". Use the box as an accuracy guide when printing templates.

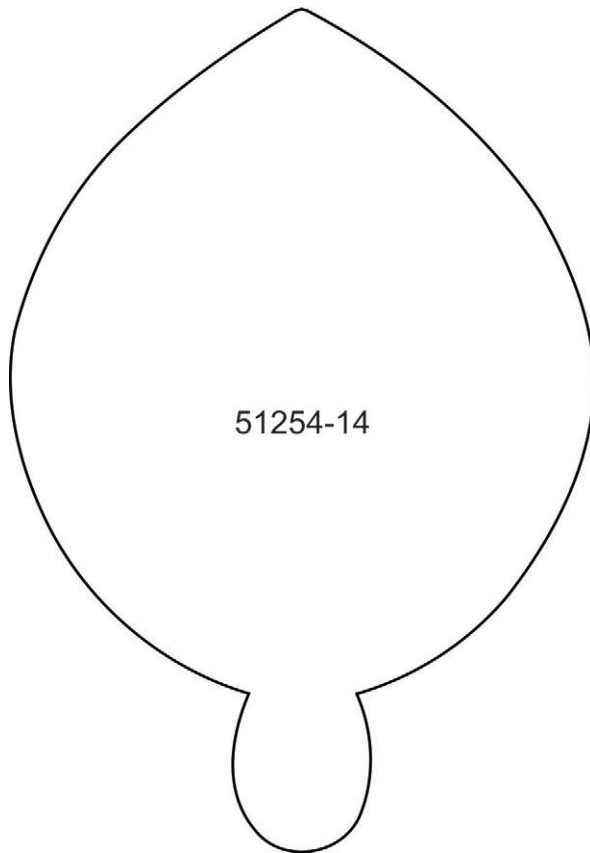

51254-14



51254-15