



#51303  
10 DESIGNS

## Adorable Autumn



It is a violation of Copyright law to make and distribute copies of electronic designs or artwork.  
Electronic designs are licensed to the original purchaser for use at one location. ©2022 OESD, LLC. All rights reserved.

# MATERIALS



## Isacord Thread Colors

- 0010 Silky White
- 0020 Black
- 0310 Yellow
- 0651 Cornsilk
- 0941 Golden Grain
- 1010 Toast
- 1055 Bark
- 1600 Spanish Tile
- 2504 Plum
- 5832 Celery

**\* Project instructions included after design list.**

**Note: One spool of 1000 meter thread is adequate for the project unless otherwise noted.**

## Table of Contents

Designs.....	03
Collection Supplies.....	08
Embroidery .....	09
Applique Patterns.....	16
Mirrored Patterns.....	21

# DESIGNS



Note: Some designs in this collection may have been created using unique special stitches and/or techniques. To preserve design integrity when rescaling or rotating designs in your software, always rescale or rotate designs using the handles directly on-screen.

## FABRIC REQUIRED

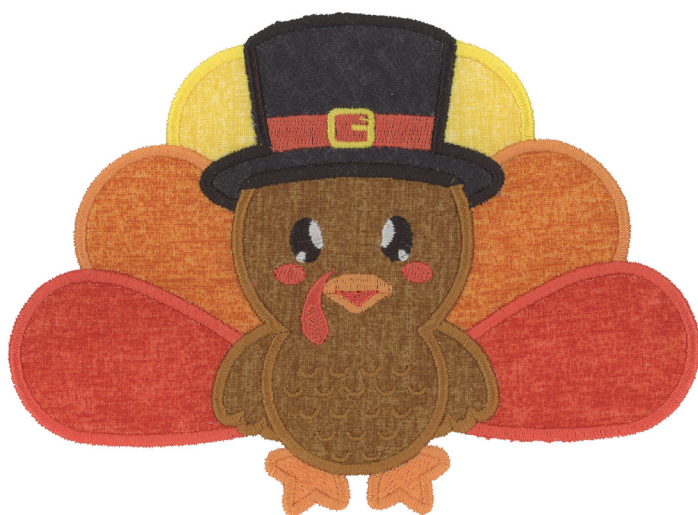

**51303-01 Adorable Turkey Applique**

Size Inches:                      Size mm:                      Stitch Count:  
**6.29 X 4.62 in. 159.8 X 117.3 mm 13145 St.**

- 1. Yellow Fabric Placement Stitch ..... 0310
- 2. Cut Line and Tackdown ..... 0310
- 3. Orange Fabric Placement Stitch ..... 0310
- 4. Cut Line and Tackdown ..... 0310
- 5. Red Fabric Placement Stitch ..... 0310
- 6. Cut Line and Tackdown ..... 0310
- 7. Black Fabric Placement Stitch ..... 0310
- 8. Cut Line and Tackdown ..... 0310
- 9. Brown Fabric Placement Stitch ..... 0310
- 10. Cut Line and Tackdown ..... 0310
- 11. Yellow Cover Stitch ..... 0310
- 12. Orange Cover Stitch and Detail ..... 1010
- 13. Red Cover Stitch and Detail ..... 1600
- 14. Black Cover Stitch and Detail ..... 0020
- 15. White Detail ..... 0010
- 16. Yellow Buckle ..... 0310
- 17. Brown Cover Stitch and Detail ..... 0941

## FABRIC REQUIRED



**51303-02 Perfect Pumpkin Applique**

Size Inches:                      Size mm:                      Stitch Count:  
**6.61 X 4.62 in. 167.9 X 117.4 mm 12724 St.**

- 1. Orange Fabric Placement Stitch ..... 0941
- 2. Cut Line and Tackdown ..... 0941
- 3. Brown Stem and Vine ..... 0941
- 4. Orange Cover Stitch ..... 1010
- 5. Tan Highlights ..... 0651
- 6. Green Lettering ..... 5832
- 7. Orange Lettering ..... 1010

# DESIGNS



Note: Some designs in this collection may have been created using unique special stitches and/or techniques. To preserve design integrity when rescaling or rotating designs in your software, always rescale or rotate designs using the handles directly on-screen.

## FABRIC REQUIRED



**51303-03 Sweetener Than Pumpkin Pie Applique**

Size Inches: 6.39 X 4.83 in.      Size mm: 162.3 X 122.7 mm      Stitch Count: 17192 St.

- 1. Tan Fabric Placement Stitch..... 1010
- 2. Cut Line and Tackdown ..... 1010
- 3. Orange Fabric Placement Stitch ..... 1010
- 4. Cut Line and Tackdown ..... 1010
- 5. White Fabric Placement Stitch ..... 1010
- 6. Cut Line and Tackdown ..... 1010
- 7. Orange Cover Stitch and Detail..... 1010
- 8. Tan Cover Stitch and Detail..... 0651
- 9. White Cover Stitch and Detail ..... 0010
- 10. Brown Lettering ..... 0941
- 11. Tan Lettering and Swirl..... 0651
- 12. Orange Lettering ..... 1010

## FABRIC REQUIRED



**51303-04 Wide Eyed Turkey Applique**

Size Inches: 6.05 X 3.18 in.      Size mm: 153.7 X 80.9 mm      Stitch Count: 9708 St.

- 1. White Fabric Placement Stitch ..... 0010
- 2. Cut Line and Tackdown ..... 0010
- 3. White Cover Stitch..... 0010
- 4. Black Fabric Placement Stitch..... 0941
- 5. Cut Line and Tackdown ..... 0941
- 6. Brown Detail ..... 0941
- 7. Black Cover Stitch and Detail ..... 0020
- 8. Orange Fabric Placement Stitch ..... 1600
- 9. Cut Line and Tackdown ..... 1600
- 10. Red Detail..... 1600
- 11. Orange Cover Stitch..... 1010
- 12. Yellow Buckle ..... 0310

# DESIGNS











Note: Some designs in this collection may have been created using unique special stitches and/or techniques. To preserve design integrity when rescaling or rotating designs in your software, always rescale or rotate designs using the handles directly on-screen.

## FABRIC REQUIRED



### 51303-05 Autumn Arches Applique

Size Inches: 6.09 X 4.23 in.      Size mm: 154.8 X 107.5 mm      Stitch Count: 20997 St.

	1. Orange Fabric Placement Stitch .....	1010
	2. Cut Line and Tackdown .....	1010
	3. Orange Cover Stitch .....	1010
	4. Purple Detail .....	2504
	5. Green Detail .....	5832
	6. Yellow Detail .....	0310
	7. Orange Detail .....	1010
	8. Brown Detail .....	0941
	9. White Detail .....	0010

## FABRIC REQUIRED

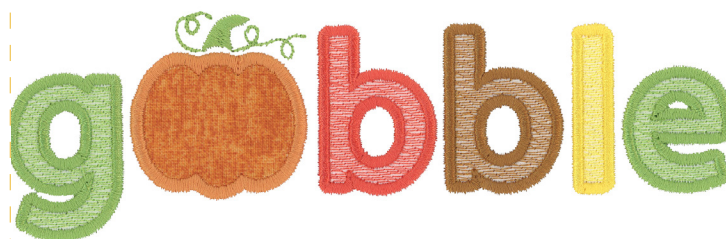

### 51303-06 Gobble Applique

Size Inches: 6.78 X 2.14 in.      Size mm: 172.1 X 54.2 mm      Stitch Count: 9461 St.

	1. Orange Fabric Placement Stitch .....	1010
	2. Cut Line and Tackdown .....	1010
	3. Orange Cover Stitch .....	1010
	4. Red Detail .....	1600
	5. Brown Detail .....	0941
	6. Yellow Detail .....	0310
	7. Green Detail .....	5832

# DESIGNS



Note: Some designs in this collection may have been created using unique special stitches and/or techniques. To preserve design integrity when rescaling or rotating designs in your software, always rescale or rotate designs using the handles directly on-screen.

## FABRIC REQUIRED



**51303-07 My First Football Season Applique**

Size Inches: 5.52 X 4.76 in.      Size mm: 140.3 X 121.0 mm      Stitch Count: 14487 St.

- 1. Brown Fabric Placement Stitch ..... 1055
- 2. Cut Line and Tackdown ..... 1055
- 3. Dark Brown Football Detail..... 1055
- 4. White Football Detail ..... 0010
- 5. Brown Cover Stitch..... 0941
- 6. Tan Lettering..... 0651
- 7. Brown Lettering ..... 0941
- 8. Dark Brown One Outline ..... 1055

## FABRIC REQUIRED



**51303-08 Scary Cute Kitty Applique**

Size Inches: 6.53 X 4.73 in.      Size mm: 165.7 X 120.1 mm      Stitch Count: 13750 St.

- 1. Black Fabric Placement Stitch..... 0010
- 2. Cut Line and Tackdown ..... 0010
- 3. White Bones ..... 0010
- 4. Black Cover Stitch ..... 0020
- 5. Black Lettering..... 0020
- 6. Orange Lettering ..... 1010

# DESIGNS



Note: Some designs in this collection may have been created using unique special stitches and/or techniques. To preserve design integrity when rescaling or rotating designs in your software, always rescale or rotate designs using the handles directly on-screen.

## FABRIC REQUIRED



### 51303-09 Wanna Hang Bat Applique

Size Inches: 6.76 X 4.63 in.      Size mm: 171.7 X 117.6 mm      Stitch Count: 11060 St.

- 1. Black Fabric Placement Stitch..... 1010
- 2. Cut Line and Tackdown ..... 1010
- 3. Orange Bat Detail..... 1010
- 4. Yellow Ears..... 0310
- 5. Red Tongue ..... 1600
- 6. White Bat Detail..... 0010
- 7. Black Cover Stitch and Detail..... 0020
- 8. Black Lettering..... 0020
- 9. Orange Lettering ..... 1010

## FABRIC REQUIRED



### 51303-10 Friendly Ghost Applique

Size Inches: 4.74 X 5.42 in.      Size mm: 120.5 X 137.7 mm      Stitch Count: 10711 St.

- 1. White Fabric Placement Stitch ..... 0010
- 2. Cut Line and Tackdown ..... 0010
- 3. Purple Detail..... 2504
- 4. Black Detail ..... 0020
- 5. Orange Detail ..... 1010
- 6. White Cover Stitch and Detail ..... 0010
- 7. Brown Stick ..... 0941

# MATERIALS



## Stabilizers

- OESD Fusible Woven
- OESD StabilStick TearAway

## Fabrics/Textiles

- Start Here by OESD Tea Towel White
- Tan quilter's cotton (1) 3" x 4"
- Orange quilter's cotton (1) 4" x 6"
- White quilter's cotton (1) 4" x 4"

Note: Fabric sizes are estimates and may result in overage.

## Notion & Tools

- OESD Expert Embroidery Tape TearAway
- OESD Perfect Embroidery Press Cloth
- Embroidery Needle Sharp 75/11

## Isacord Thread Colors

- Per thread chart



# EMBROIDERY



## General Instructions

The applique instructions, included in the collection, are general instructions. For demonstration purposes, a sample design that best demonstrates the technique is shown.

Fabric and thread requirements will vary by design, but the general technique is the same.

All designs are stitched with matching thread, top, and bobbin.

Note: Some thread colors in instructions have been changed or digitally enhanced for better visibility.

### □ Step 1

- Apply one layer of Fusible Woven to the wrong side of the applique fabric.



### □ Step 2

- Hoop the desired stabilizer.
- Example stabilizer is StabilStick TearAway.
- Float Tea Towel on stabilizer.



# EMBROIDERY



## □ Step 3

- Load selected design into the machine.
- Example design is 51303-03.
- Thread the machine per the thread chart.
- Place the hoop on the machine.
- Stitch Machine Step 1, Tan Placement Stitch.

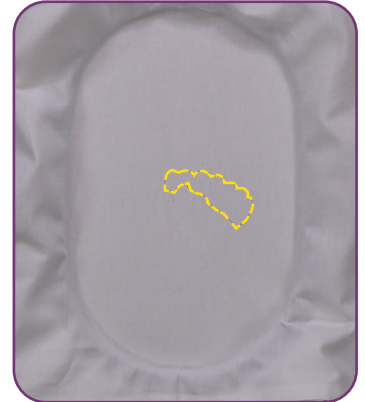

## □ Step 4

- Remove the hoop from the machine, but NOT the project from the hoop.
- Completely cover the placement stitch with the prepared fabric.
- Tape in place to secure.
- Return the hoop to the machine.

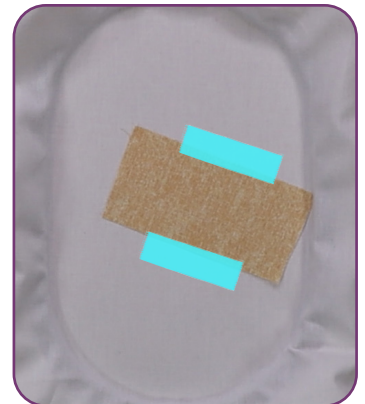

## □ Step 5

- Stitch Machine Step 2, Cut Line and Tackdown.



# EMBROIDERY



## □ Step 6

- Remove the hoop from the machine, but NOT the project from the hoop.
- Place on a flat surface.
- Trim the excess fabric as close to the cut line as possible.
- Note: If the outermost stitches (cut line) are cut, the inner stitches (tackdown) will hold the applique in place.



## □ Step 7

- Place the hoop on the machine.
- Stitch Machine Step 3, Orange Fabric Placement Stitch.



## □ Step 8

- Remove the hoop from the machine, but NOT the project from the hoop.
- Completely cover the placement stitch with the prepared fabric.
- Tape in place to secure.
- Return the hoop to the machine.



# EMBROIDERY



## □ Step 9

- Stitch Machine Step 4, Cut Line and Tackdown.



## □ Step 10

- Remove the hoop from the machine, but NOT the project from the hoop.
- Place on a flat surface.
- Trim the excess fabric as close to the cut line as possible.



## □ Step 11

- Stitch Machine Step 5, White Fabric Placement Stitch.



# EMBROIDERY



## □ Step 12

- Remove the hoop from the machine, but NOT the project from the hoop.
- Completely cover the placement stitch with the prepared fabric.
- Tape in place to secure.
- Return the hoop to the machine.

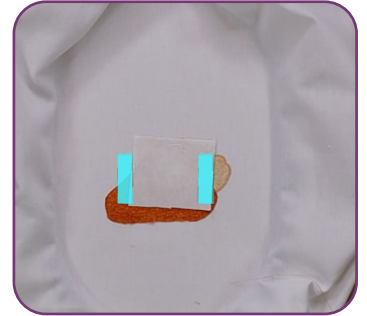

## □ Step 13

- Stitch Machine Step 6, Cut Line and Tackdown.
- Remove the hoop from the machine, but NOT the project from the hoop.
- Place on a flat surface.
- Trim the excess fabric as close to the cut line as possible.



## □ Step 14

- Return the hoop to the machine and stitch the remaining steps per the thread chart.



# EMBROIDERY



## □ Step 15

- When the design is complete, remove the project from the hoop and trim the stabilizer 1/4" - 1/2" outside the design.
- Press right side down on a Perfect Embroidery Press Cloth.



# PRINTING INSTRUCTIONS



## ATTENTION

When printing this document, any page scaling or page fitting options in your print dialog box must be turned OFF or set to NONE so that your files will print out at their actual size. Images not printed at actual size will not function as intended.

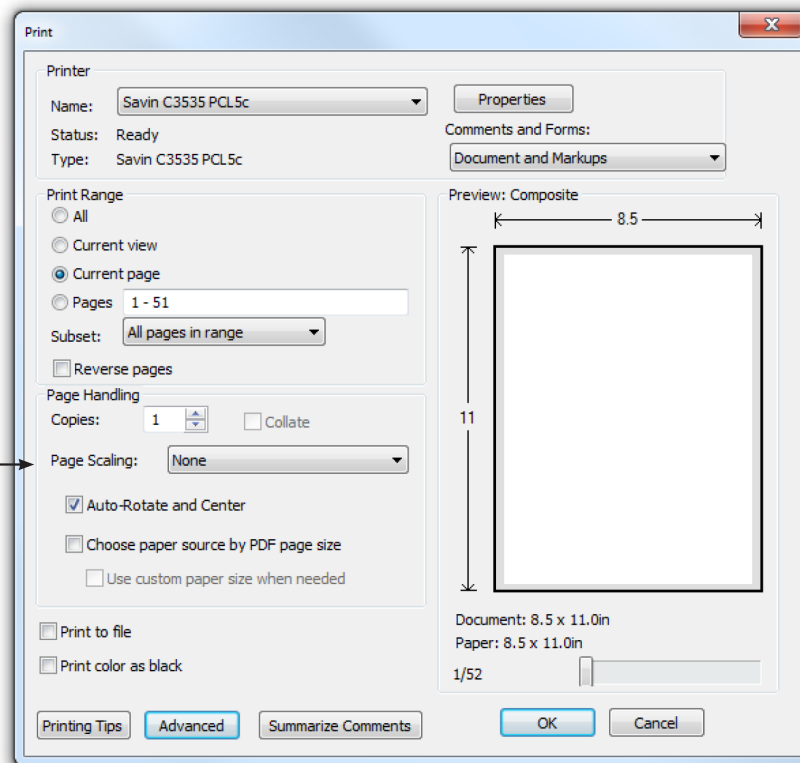

## TO SAVE PAPER

Only print the desired image by navigating to the image's page, go to File > Print and select "Current page" in the print dialog box. Repeat for each desired image.

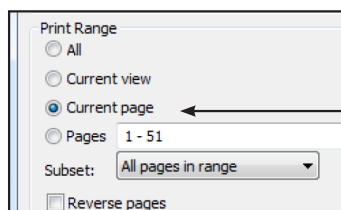

# APPLIQUE PATTERNS



Print at 100%. No scaling. This box measures 1" x 1". Use the box as an accuracy guide when printing templates.

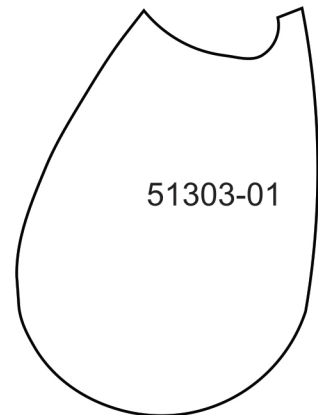
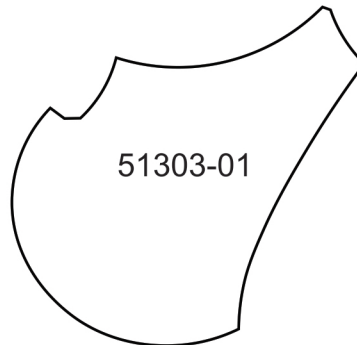
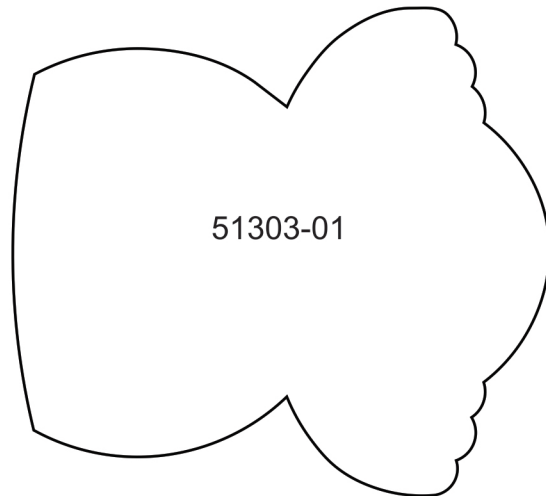
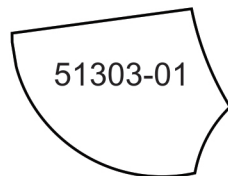
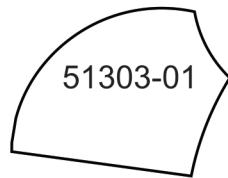
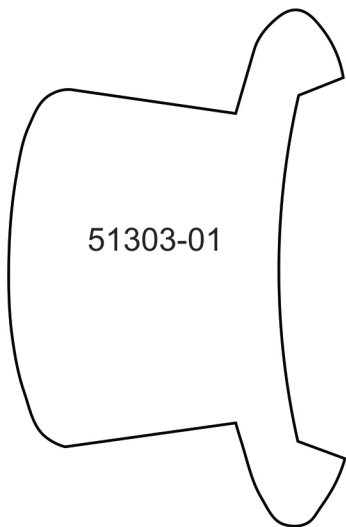



# APPLIQUE PATTERNS

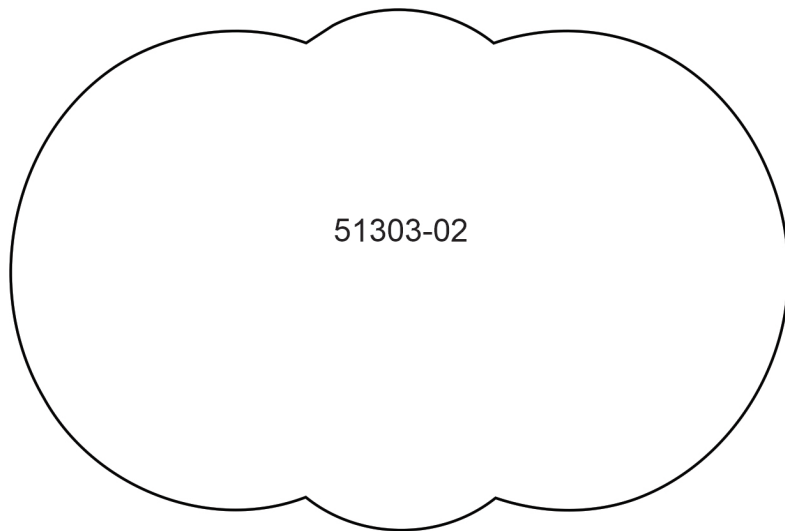

Print at 100%. No scaling. This box measures 1" x 1". Use the box as an accuracy guide when printing templates.

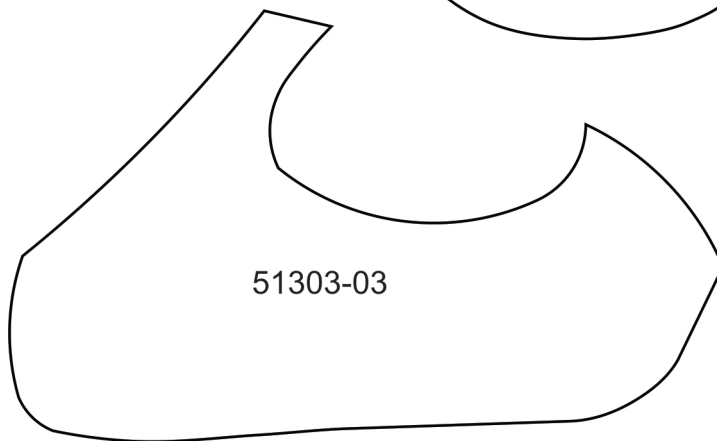
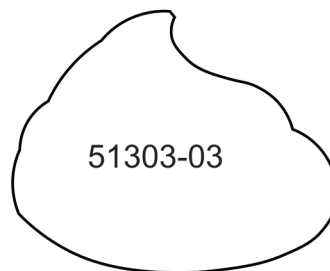

# APPLIQUE PATTERNS



Print at 100%. No scaling. This box measures 1" x 1". Use the box as an accuracy guide when printing templates.

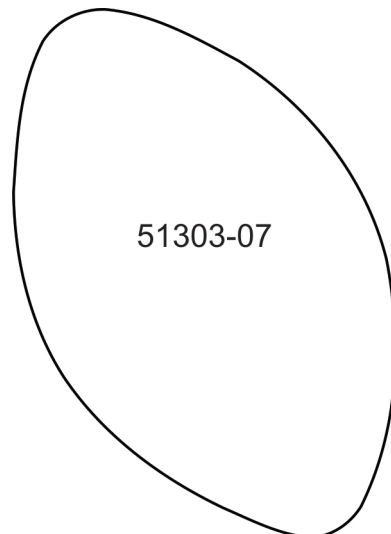
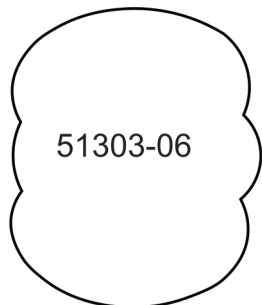
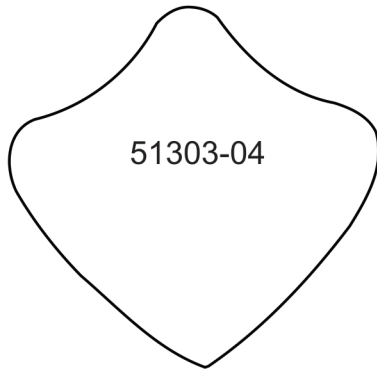
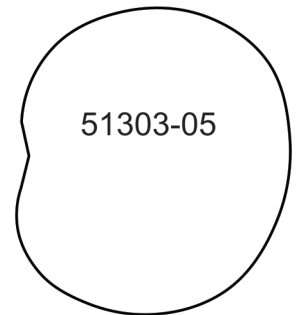
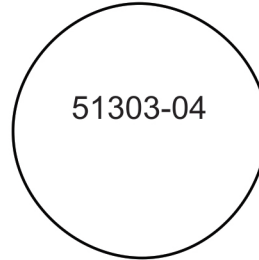
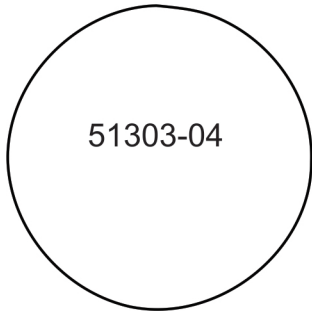
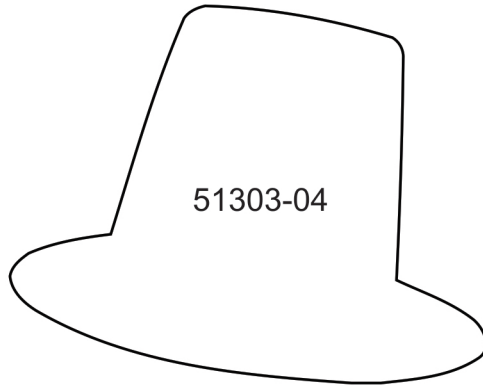

# APPLIQUE PATTERNS



Print at 100%. No scaling. This box measures 1" x 1". Use the box as an accuracy guide when printing templates.

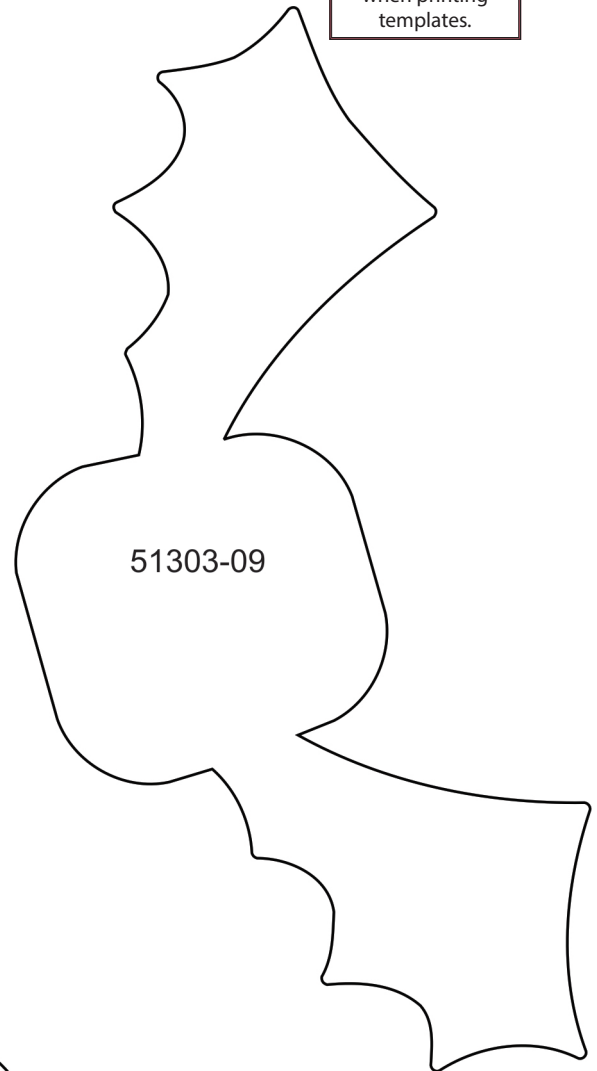

# APPLIQUE PATTERNS



Print at 100%. No scaling. This box measures 1" x 1". Use the box as an accuracy guide when printing templates.

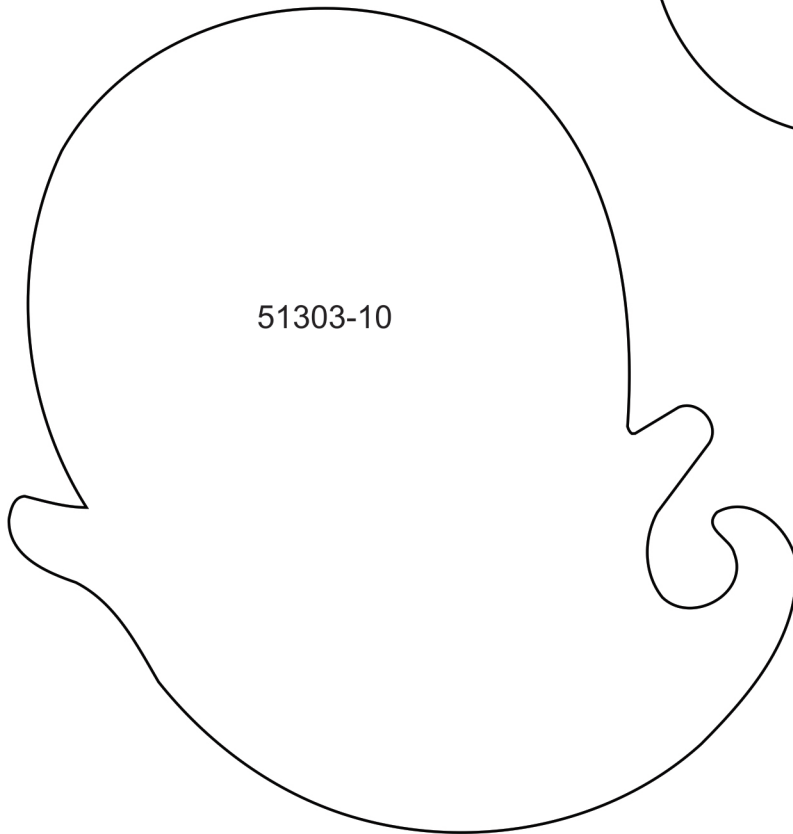
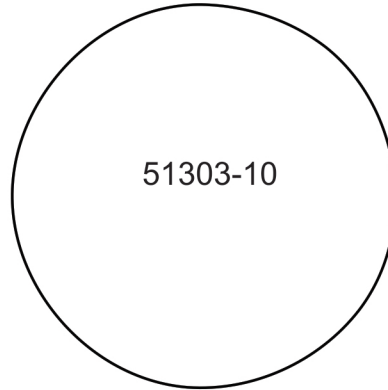

# MIRRORED PATTERNS



Print at 100%. No scaling. This box measures 1" x 1". Use the box as an accuracy guide when printing templates.

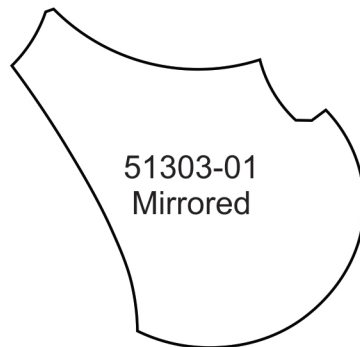
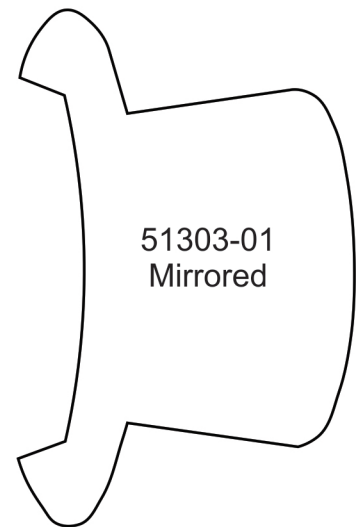
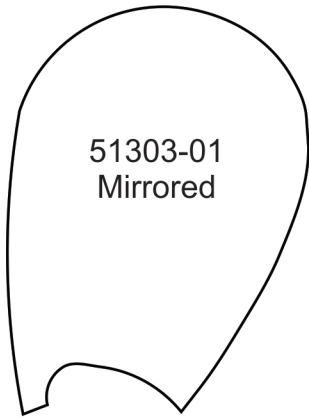

# MIRRORED PATTERNS



Print at 100%. No scaling. This box measures 1" x 1". Use the box as an accuracy guide when printing templates.

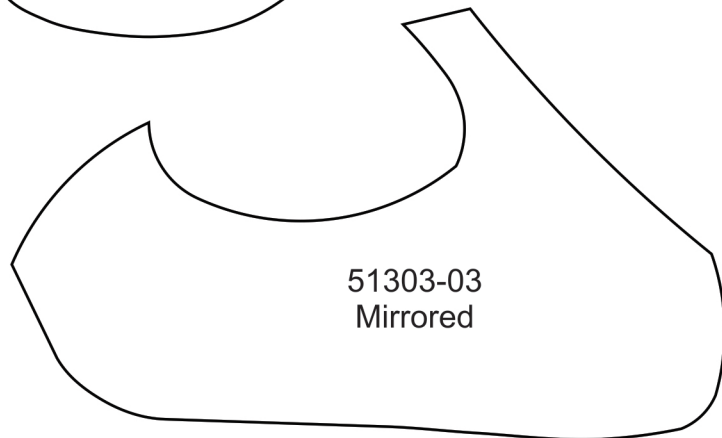
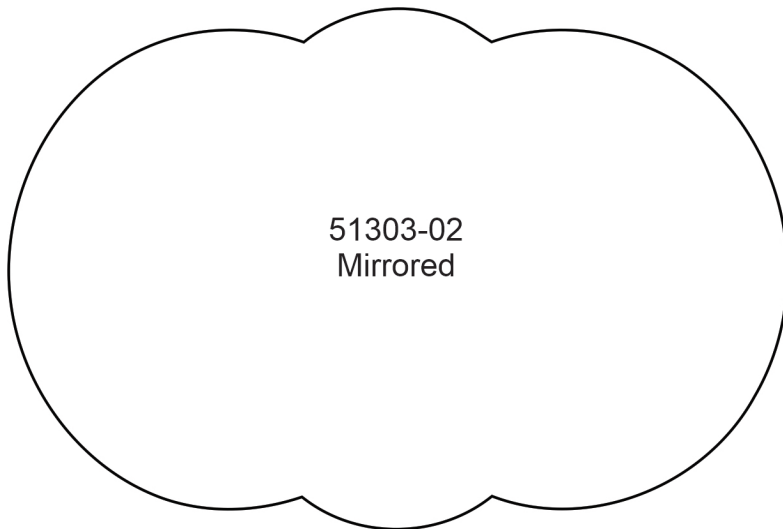

# MIRRORED PATTERNS



Print at 100%. No scaling. This box measures 1" x 1". Use the box as an accuracy guide when printing templates.

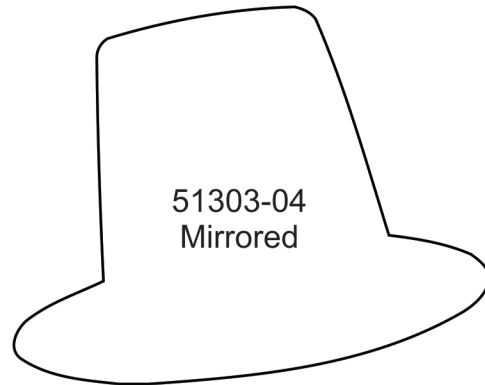

51303-04  
Mirrored



51303-04  
Mirrored

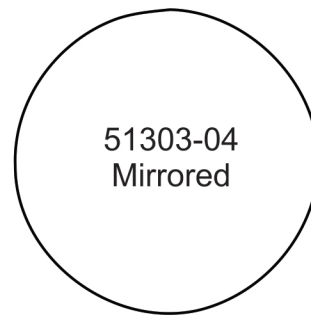

51303-04  
Mirrored



51303-04  
Mirrored

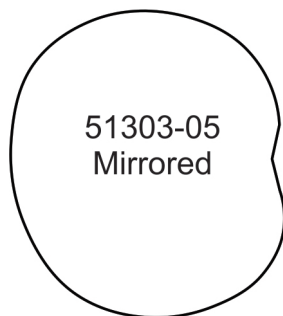

51303-05  
Mirrored



51303-06  
Mirrored

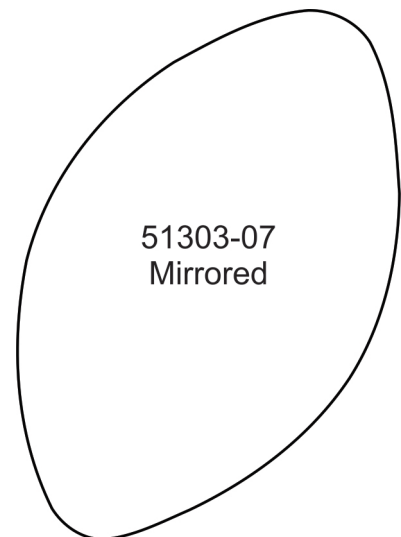

51303-07  
Mirrored

# MIRRORED PATTERNS



Print at 100%. No scaling. This box measures 1" x 1". Use the box as an accuracy guide when printing templates.

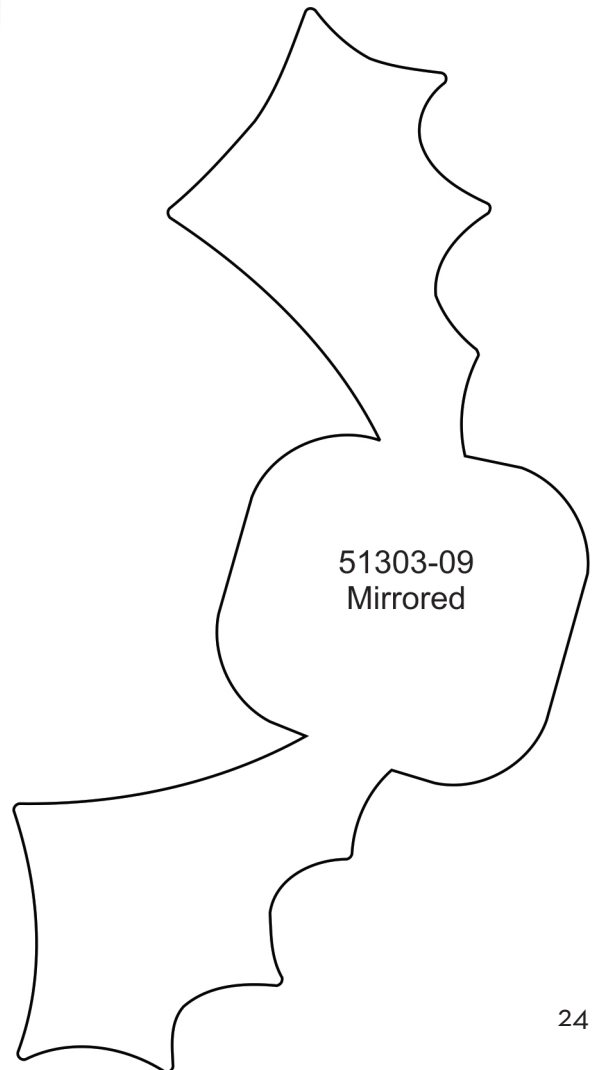
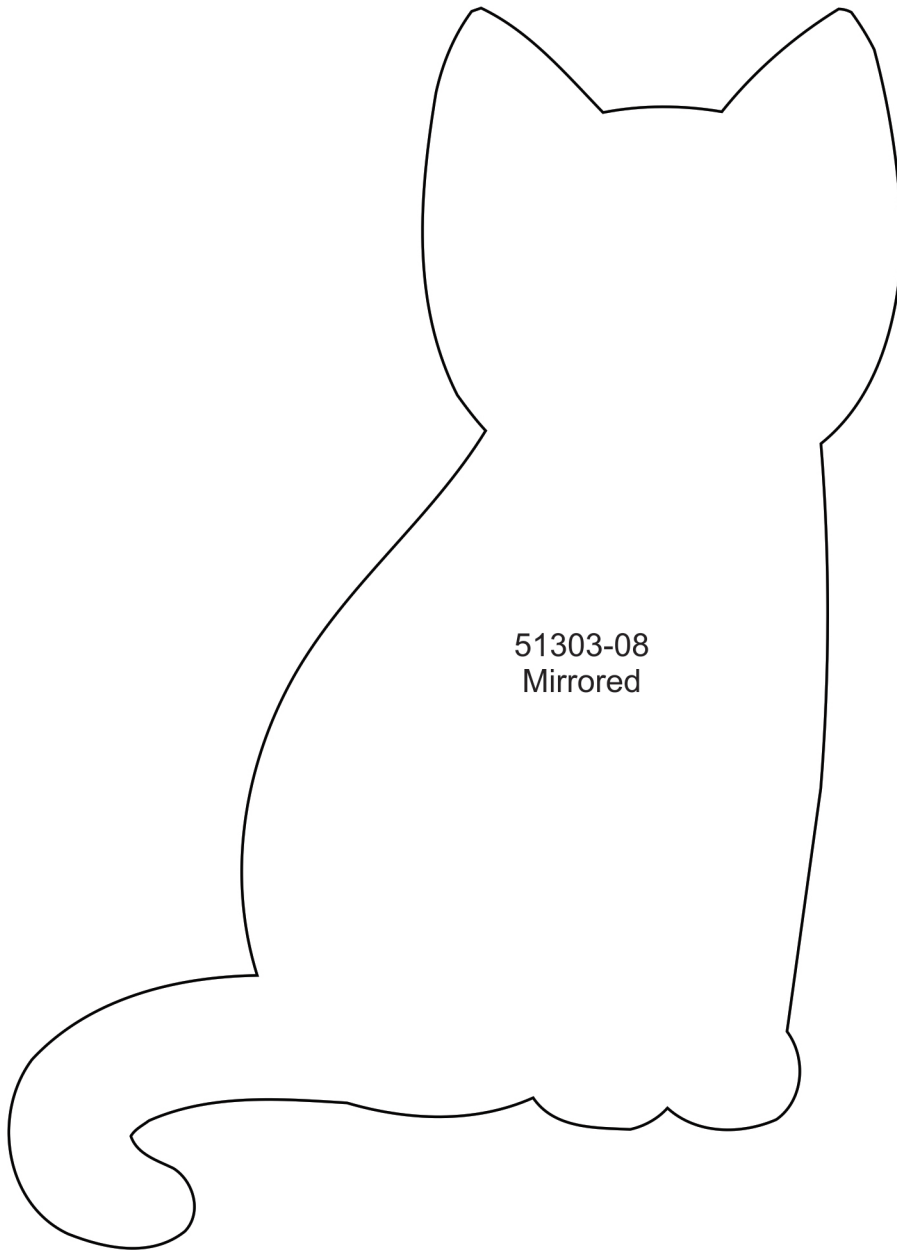



# MIRRORED PATTERNS



Print at 100%. No scaling. This box measures 1" x 1". Use the box as an accuracy guide when printing templates.

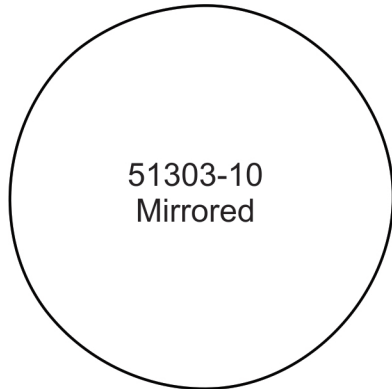

51303-10  
Mirrored



51303-10  
Mirrored