

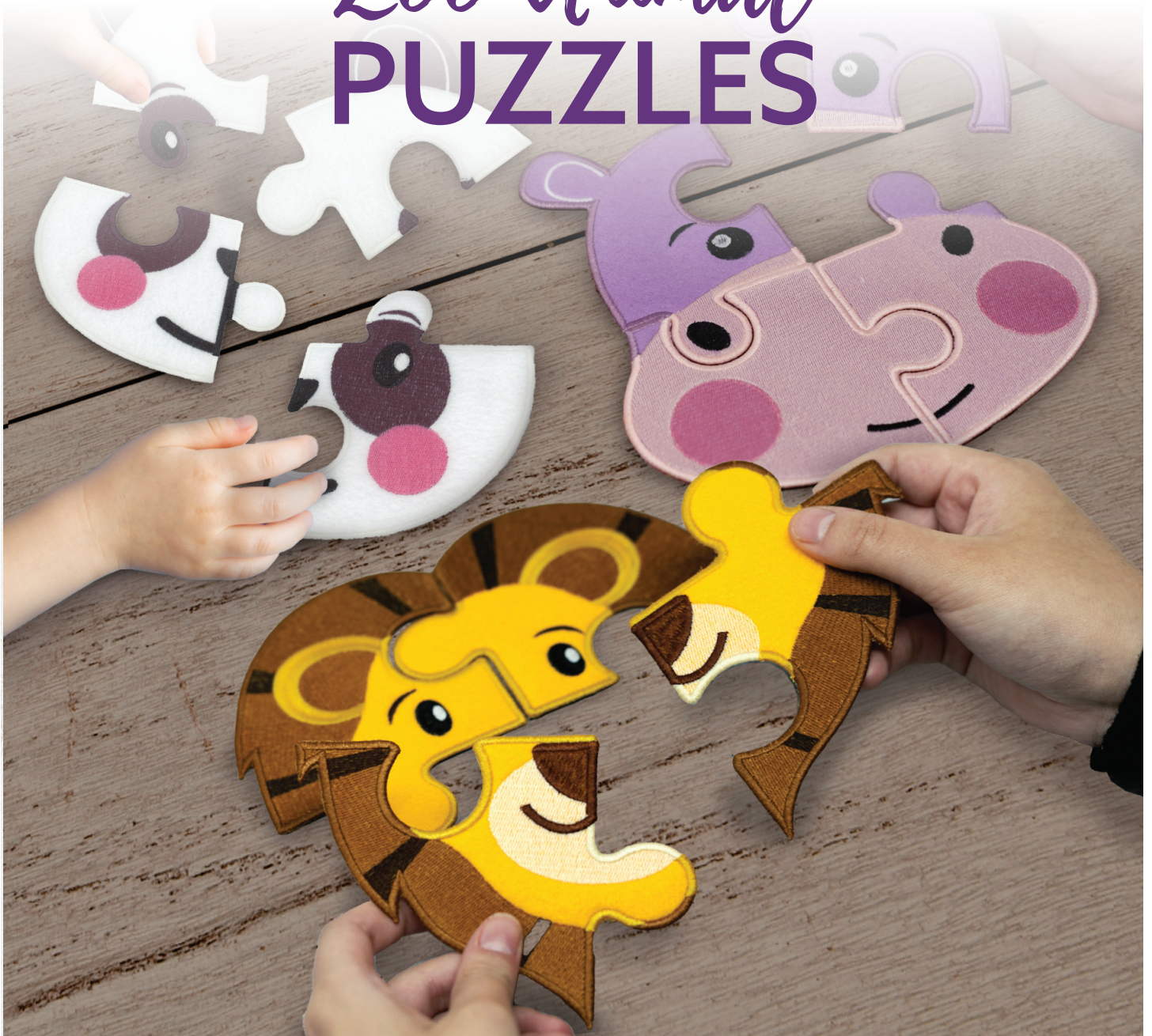

#51327
4 DESIGNS/16 FILES

Zoo Animal PUZZLES



It is a violation of Copyright law to make and distribute copies of electronic designs or artwork.
Electronic designs are licensed to the original purchaser for use at one location. ©2023 OESD, LLC. All rights reserved.

MATERIALS



Isacord Thread Colors

0010 Silky White	0660 Vanilla	1346 Cinnamon
0020 Black	1032 Bronze	1860 Shell
0132 Dark Pewter	1060 Shrimp Pink	2152 Heather Pink
0622 Star Gold	1342 Rust	2764 Violet

Note: One spool of 1000 meter thread is adequate for the project unless otherwise noted.

MATERIALS



Stabilizers

- OESD AquaMesh WashAway
- OESD BadgeMaster WashAway
- OESD Applique Fuse and Fix
- OESD Fiber Form
- OESD Top Cover
- OESD StitcH2O

Fabrics/Textiles

- Felt (front of puzzles): White 8 pieces 5" x 6", Pink 4 pieces 5" x 6", Dark Yellow 4 pieces 5" x 6"
- Fabric (back of puzzles): White 8 pieces 5" x 6", Pink 4 pieces 5" x 6", Dark Yellow 4 pieces 5" x 6"

Notion & Tools

- OESD Expert Embroidery Tape TearAway
- OESD Expert Embroidery Tape WashAway
- OESD Perfect Embroidery Press Cloth
- Embroidery Needle Sharp 80/12

Isacord Thread Colors

- Per thread chart.

SUMMARY

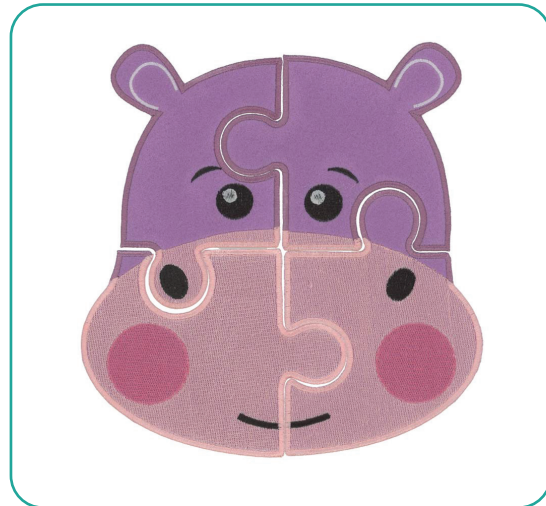

51327-01

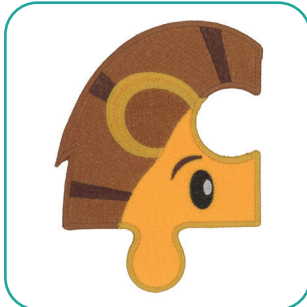

51327-02



51327-05

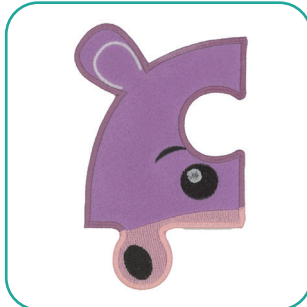

51327-06

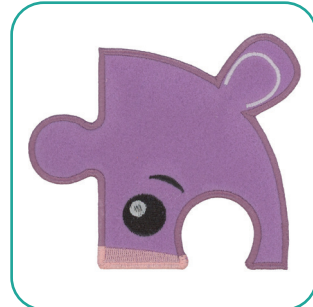

51327-03



51327-04



51327-07

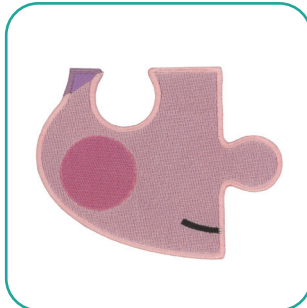

51327-08

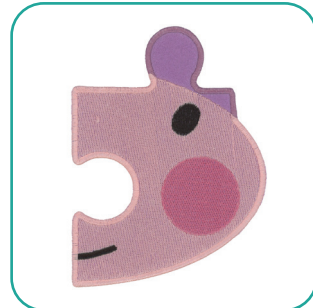

SUMMARY



51327-09



51327-10



51327-13



51327-14



51327-11



51327-12



51327-15



51327-16



EMBROIDERY



General Instructions

The freestanding applique instructions, included in the collection, are general instructions. For demonstration purposes, a sample design that best demonstrates the technique is shown.

Fabric and thread requirements will vary by design, but the general technique is the same. All designs are stitched with matching thread, top and bobbin.

Note: Some thread colors in instructions have been changed or digitally enhanced for better visibility.

Step 1

- Print the mirrored version of the required templates (at 100% or 1:1 ratio) onto the paper side of Applique Fuse and Fix.
- Cut approximately 1/4" -1/2" outside the printed applique templates.



Step 2

- Fuse the template to the back of the Fiber Form paper side up. Hold the iron on the template for 10-15 seconds for a secure fuse.

Note: Felt can also be pre-cut. In these instructions they will be cut in place.



EMBROIDERY



Step 3

- Cut the Fiber Form out on the edge of the black outline.
- Set aside.



Step 4

- Hoop one layer of AquaMesh and one layer of BadgeMaster for all designs.

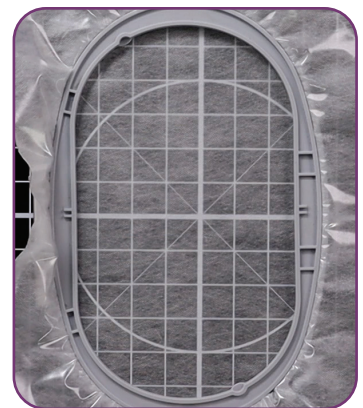

Step 5

- Load selected design into the machine.
- Example design is 51327-16.
- Thread the machine per the thread chart.
- Place the hoop on the machine.
- Stitch Machine Step 1, Fiber Form and Felt Placement Stitch.



EMBROIDERY

Step 6

- Remove the hoop from the machine, but NOT the project from the hoop.
- Place the hoop on a flat surface.
- On the back of the Fiber Form, score and remove the paper backing to reveal the adhesive surface.
- Position the Fiber Form within the placement stitch, matching the cut edges with the stitching line.
- Finger press to secure.
Note: Applique Fuse and Fix is repositionable.



Step 7

- Completely cover the placement stitch with the felt.
- Tape in place to secure.

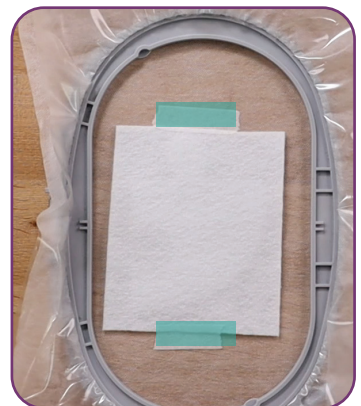

Step 8

- Return the hoop to the machine.
- Stitch Machine Step 2, Cut Line and Tackdown.



EMBROIDERY

Step 9

- Remove the hoop from the machine, but NOT the project from the hoop.
- Place the hoop on a flat surface.
- Trim the excess fabric as close to the cut line as possible.
- If the outermost stitches (cut line) are cut, the inner stitches (tackdown) will hold the applique in place.



Step 10

- Place a piece of black Top Cover over the felt.
- Tape in place to secure.
Note: Top Cover is a permanent topping that prevents fabric show-through on contrasting embroidery.

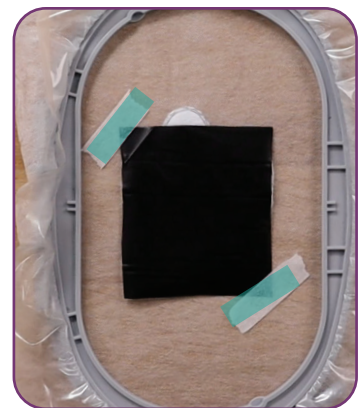

Step 11

- Return the hoop to the machine.
- Stitch Machine Step 3 and Machine Step 4.



EMBROIDERY

Step 12

- Remove the hoop from the machine, but NOT the project from the hoop.
- Place the hoop on a flat surface.
- Gently tear away the excess Top Cover.



Step 13

- Return the hoop to the machine.
- Stitch Machine Steps 5 and 6.



Step 14

- Remove the hoop from the machine, but NOT the project from the hoop.
- Place the hoop on a flat surface.
- Turn the hoop over and place the applique fabric right side up, completely covering the placement stitch.
- Carefully tape to secure.
Note: Avoid pushing too hard on the stabilizer to prevent it from dislodging from the hoop.



EMBROIDERY

Step 15

- Return the hoop to the machine.
- Stitch Machine Step 7, Back Fabric Cut Line and Tackdown.



Step 16

- Remove the hoop from the machine, but NOT the project from the hoop.
- Place the hoop on a flat surface.
- Turn the hoop over and trim the excess fabric as close to the cut line as possible.



Step 17

- Return the hoop to the machine.
- Stitch Steps 8-10, Cover Stitch.
Note: Match the bobbin to the upper thread for each separate color.



EMBROIDERY

Step 18

- When the design is complete, remove the project from the hoop and trim the stabilizer 1/4"-1/2" outside the design.
- Stitch the remaining puzzle pieces.



Step 19

- Rinse each piece in warm running water until the stabilizer is removed from the design.
- Place right side down on a non-stick surface to dry. Parchment paper or a cooling rack work well to prevent curling.
- Dry completely.
- Once dry, press right side down on a Perfect Embroidery Press Cloth.

Step 20

- Arrange puzzle pieces and enjoy!



PRINTING INSTRUCTIONS



ATTENTION

When printing this document, any page scaling or page fitting options in your print dialog box must be turned OFF or set to NONE so that your files will print out at their actual size. Images not printed at actual size will not function as intended.

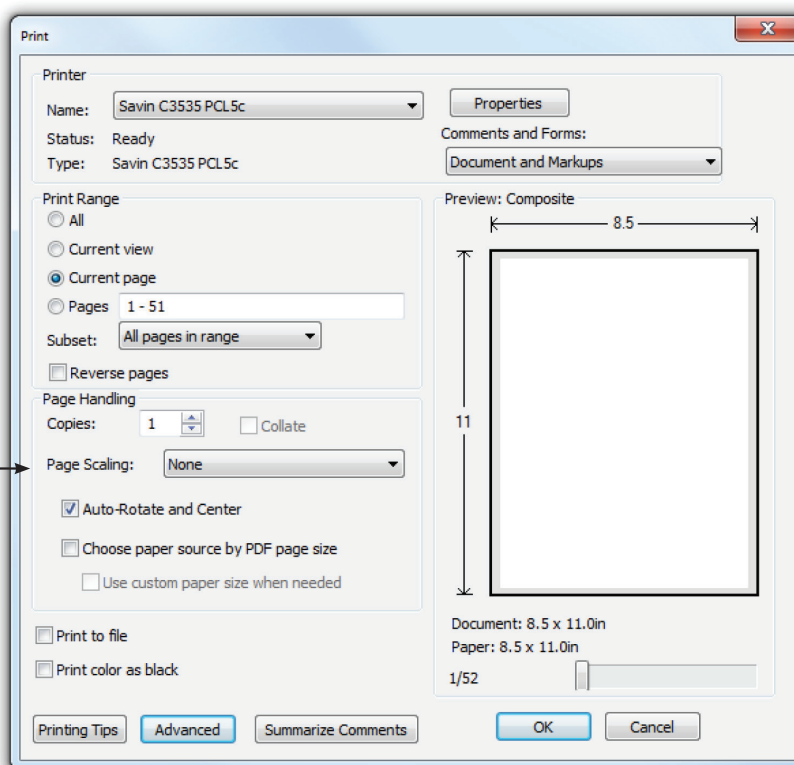

TO SAVE PAPER

Only print the desired image by navigating to the image's page, go to File > Print and select "Current page" in the print dialog box. Repeat for each desired image.

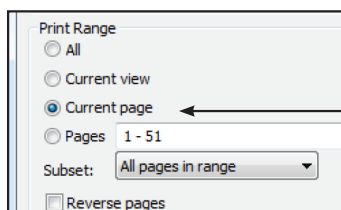

APPLIQUE PATTERNS



Print at 100%. No scaling. This box measures 1" x 1". Use the box as an accuracy guide when printing templates.

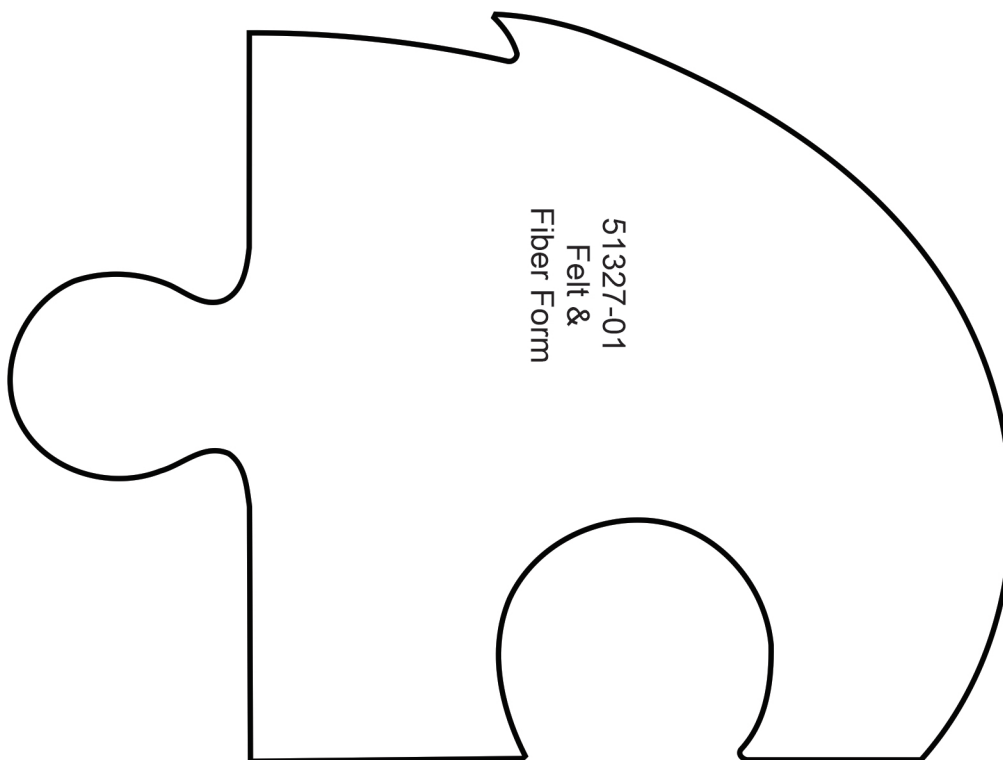

51327-01
Felt &
Fiber Form

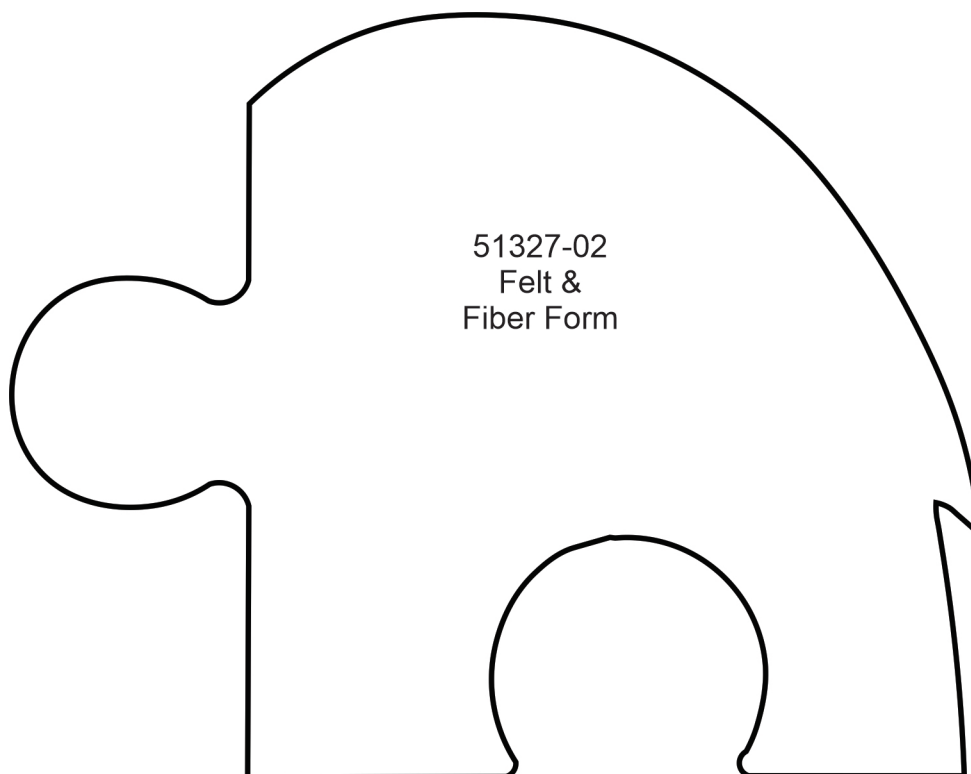

51327-02
Felt &
Fiber Form

APPLIQUE PATTERNS



Print at 100%. No scaling. This box measures 1" x 1". Use the box as an accuracy guide when printing templates.

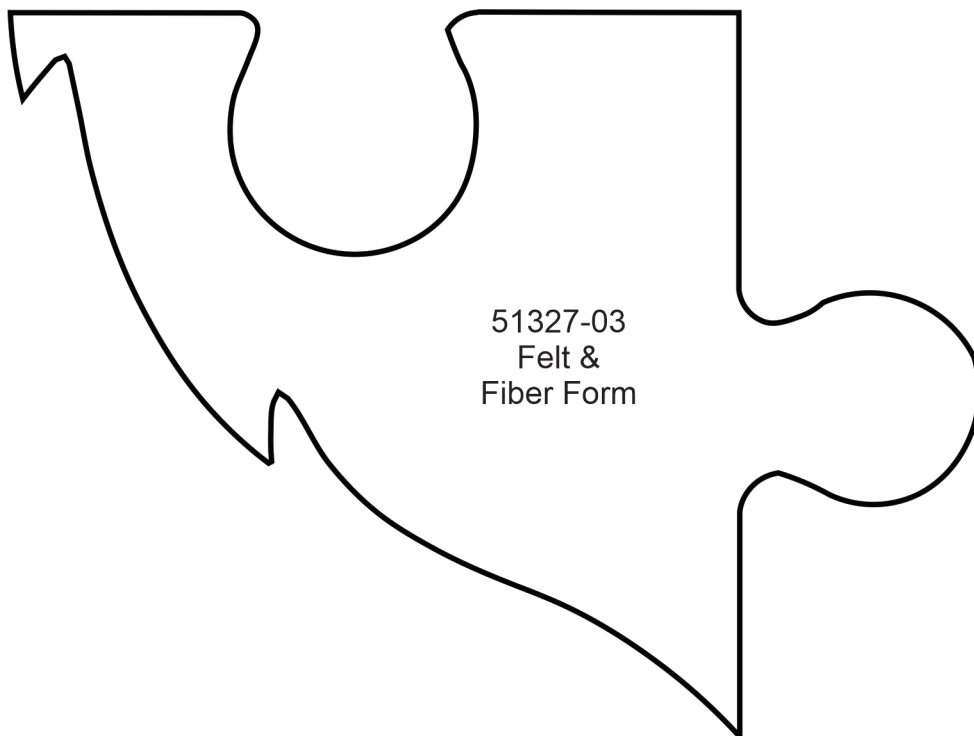

51327-03
Felt &
Fiber Form

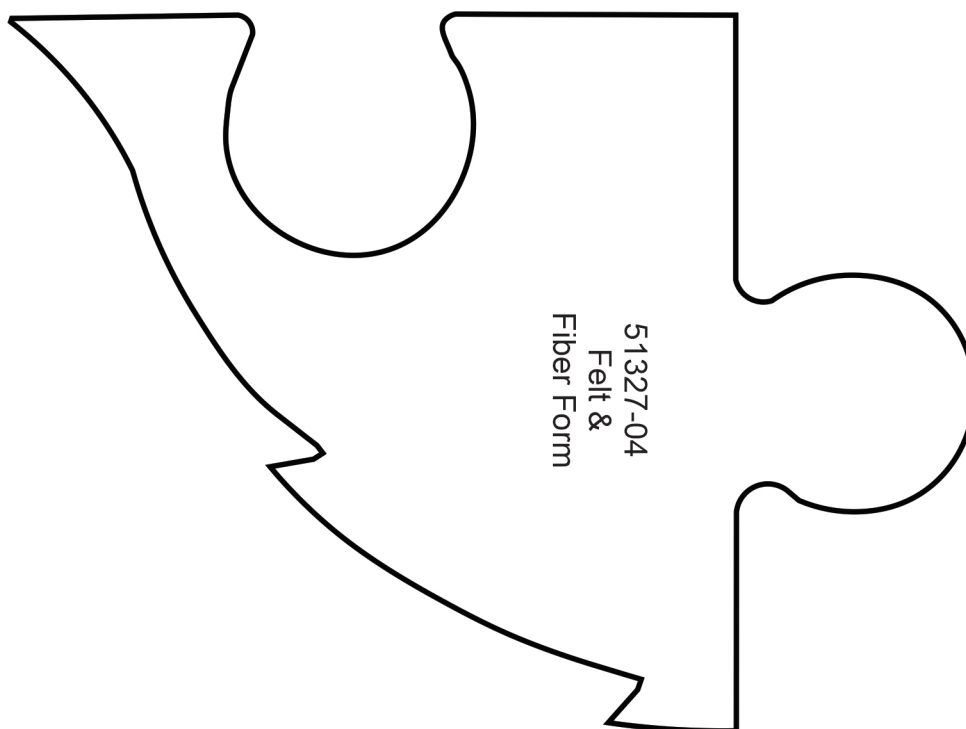

51327-04
Felt &
Fiber Form

APPLIQUE PATTERNS



Print at 100%. No scaling. This box measures 1" x 1". Use the box as an accuracy guide when printing templates.

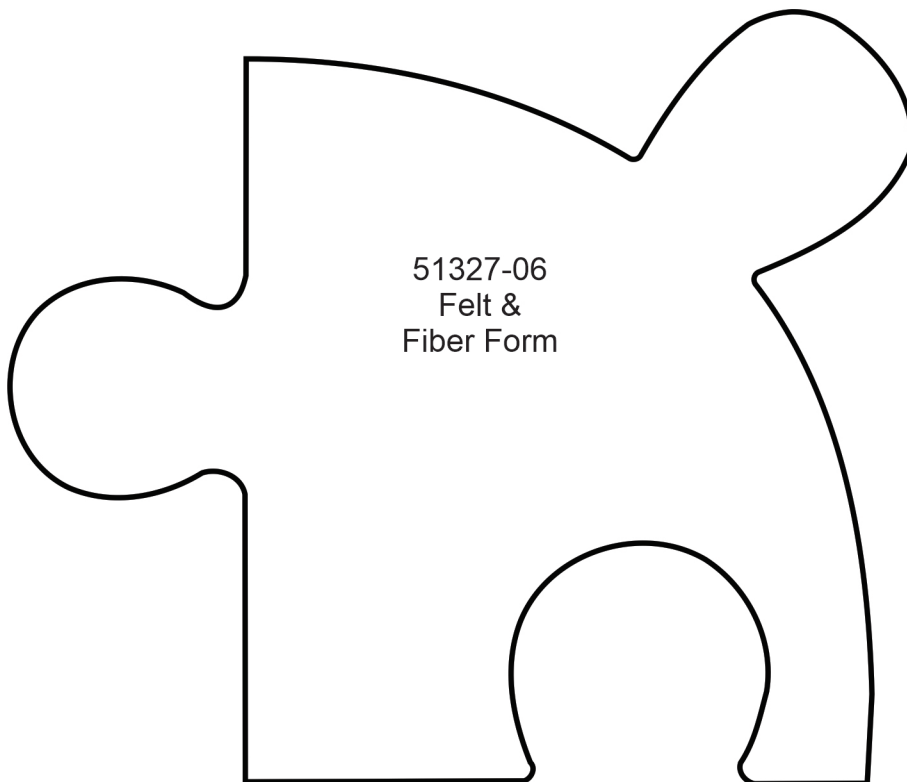
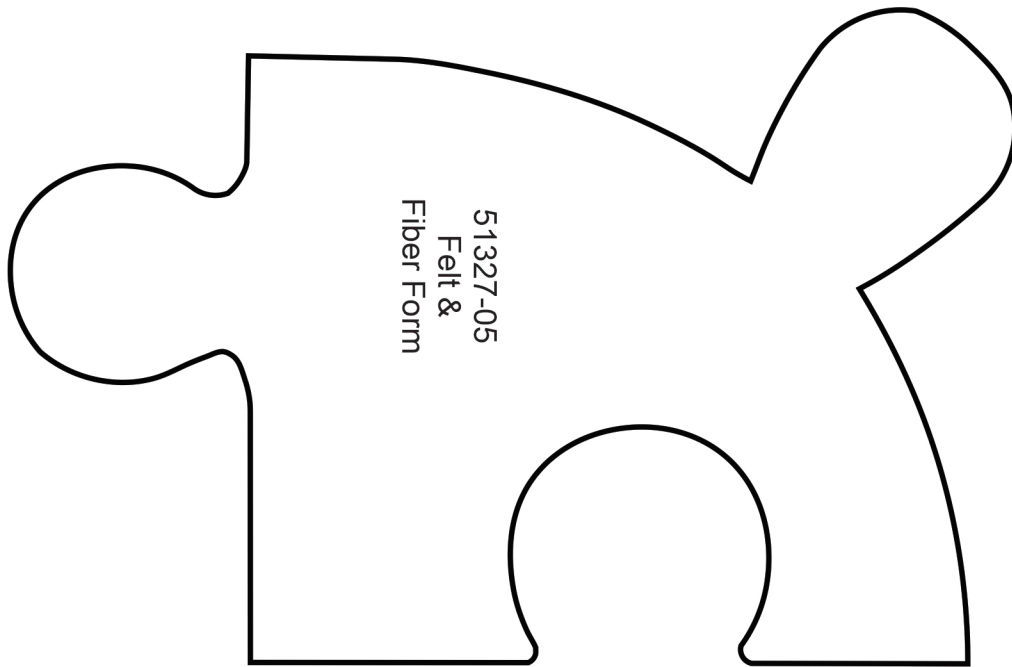

APPLIQUE PATTERNS



Print at 100%. No scaling. This box measures 1" x 1". Use the box as an accuracy guide when printing templates.

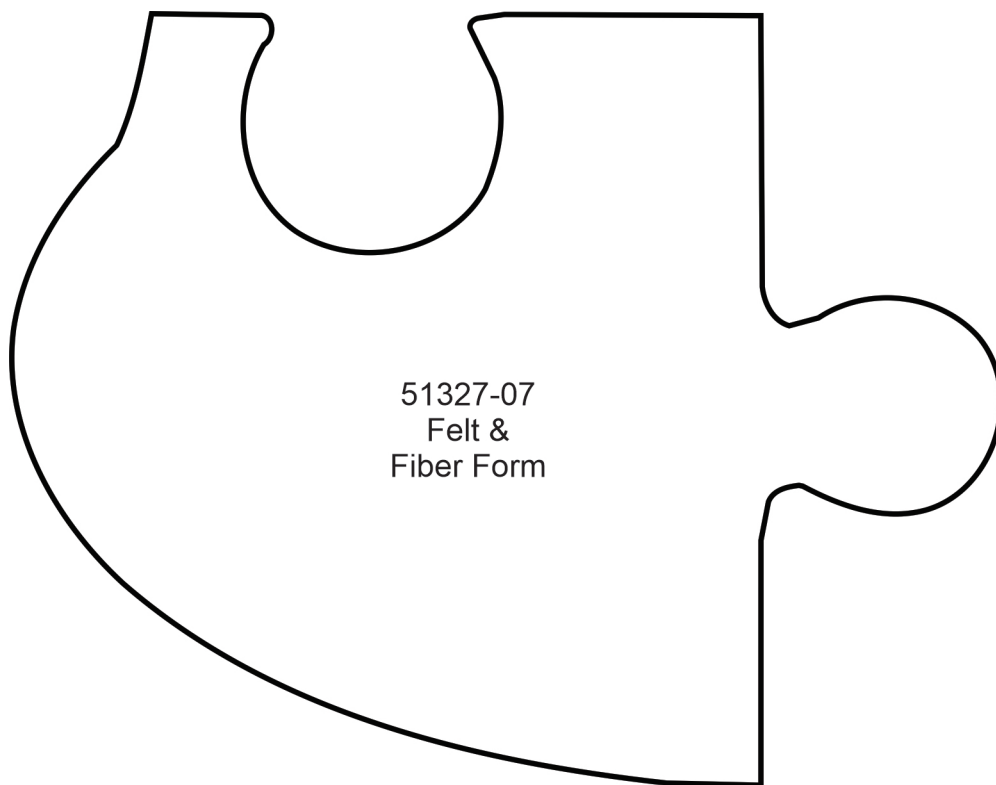

51327-07
Felt &
Fiber Form

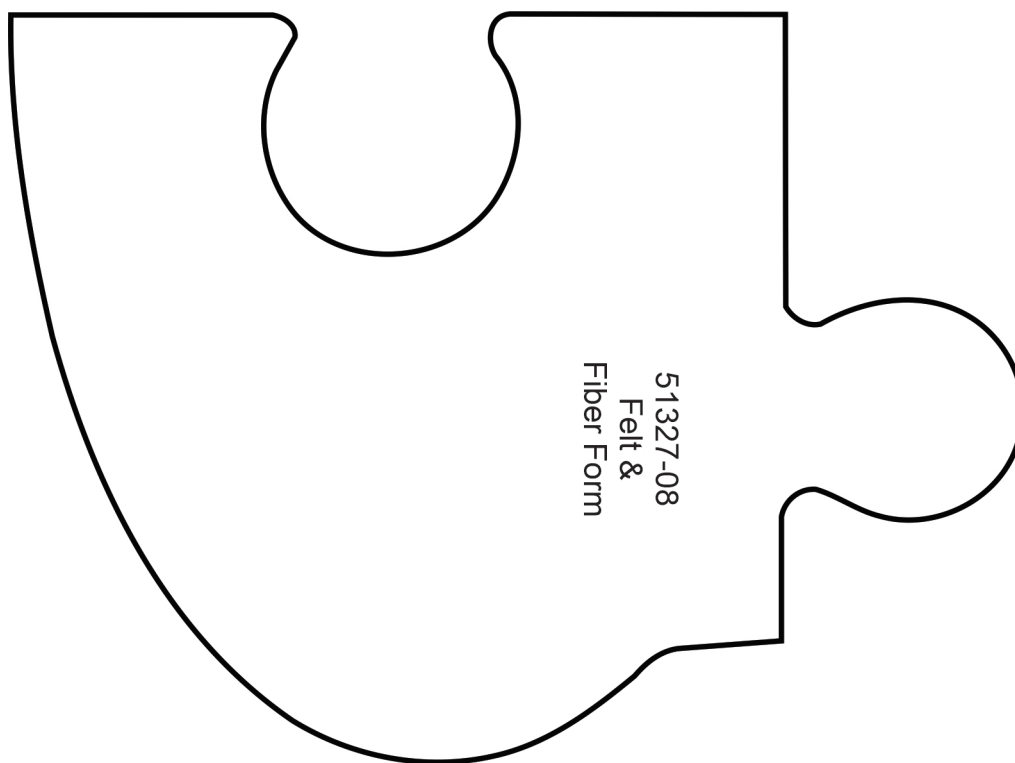

51327-08
Felt &
Fiber Form

APPLIQUE PATTERNS

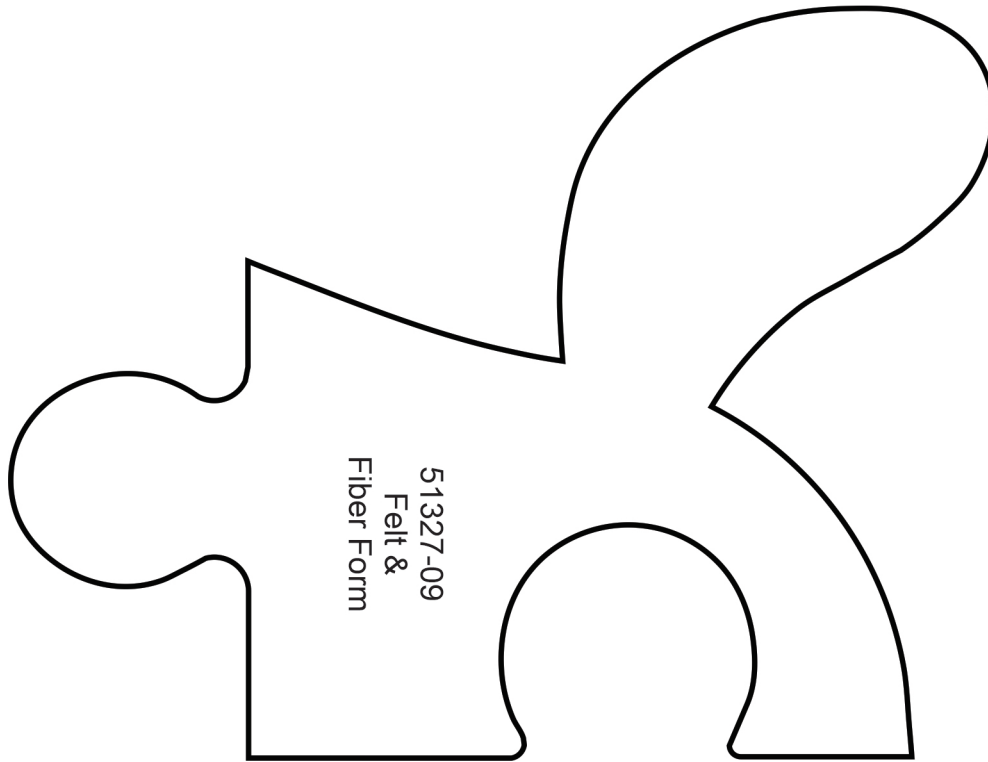

Print at 100%. No scaling. This box measures 1" x 1". Use the box as an accuracy guide when printing templates.

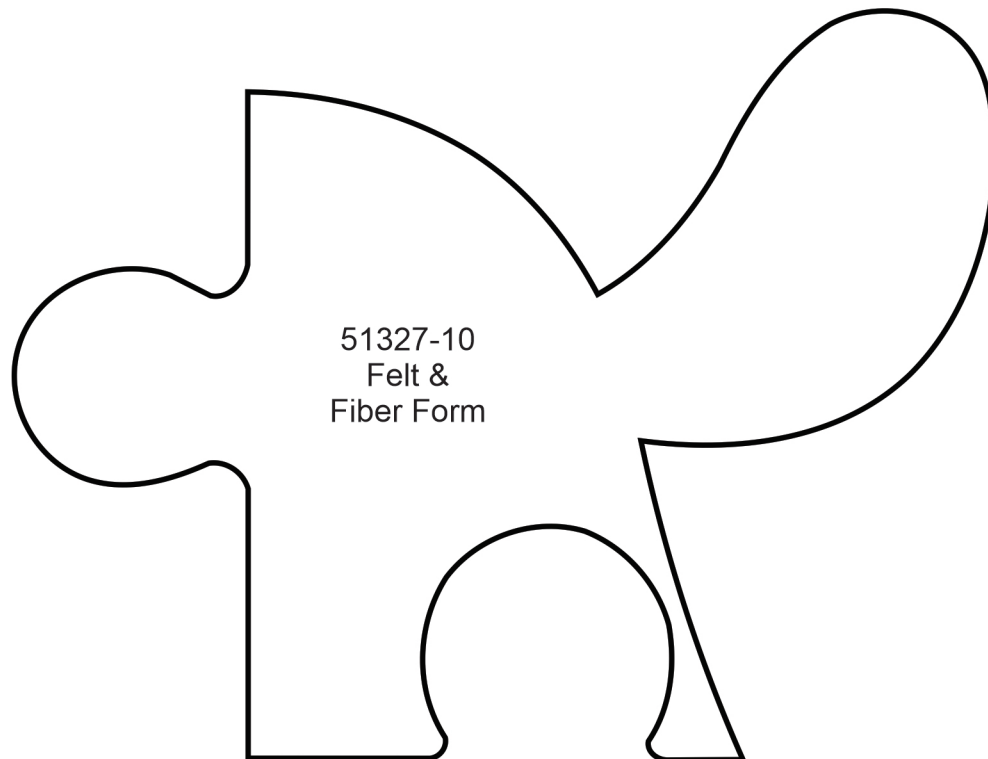

APPLIQUE PATTERNS

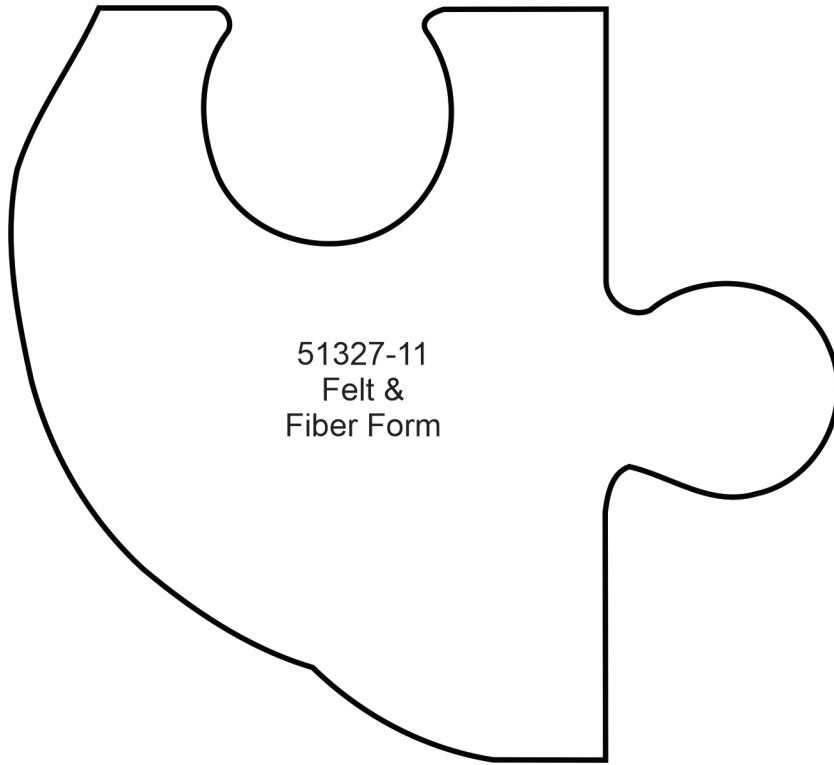

51327-11
Felt &
Fiber Form

Print at 100%. No scaling. This box measures 1" x 1". Use the box as an accuracy guide when printing templates.

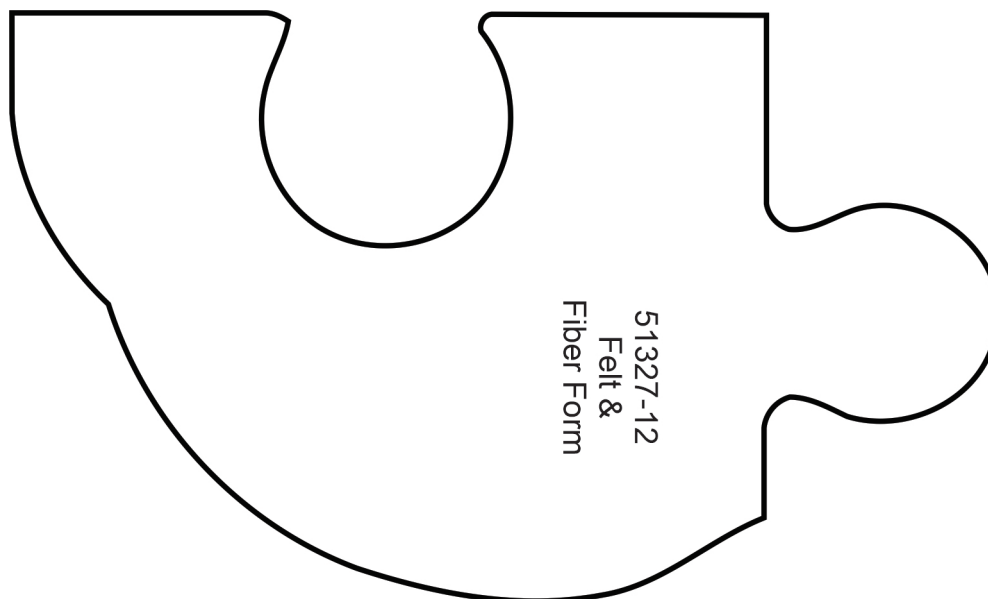

51327-12
Felt &
Fiber Form

APPLIQUE PATTERNS

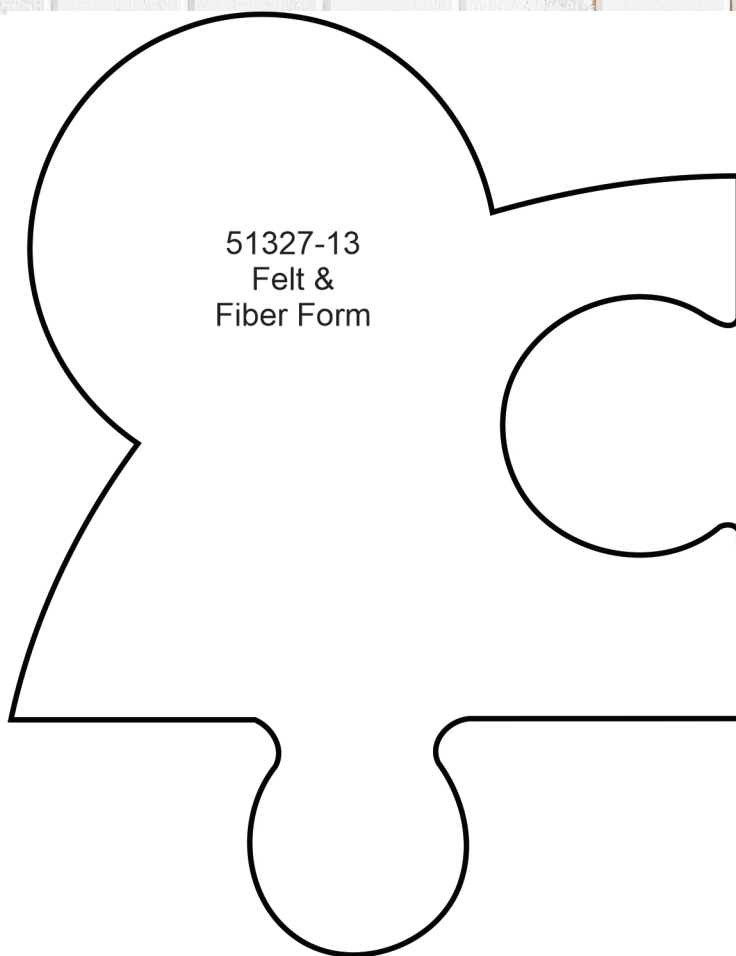

51327-13
Felt &
Fiber Form

Print at 100%. No scaling. This box measures 1" x 1". Use the box as an accuracy guide when printing templates.

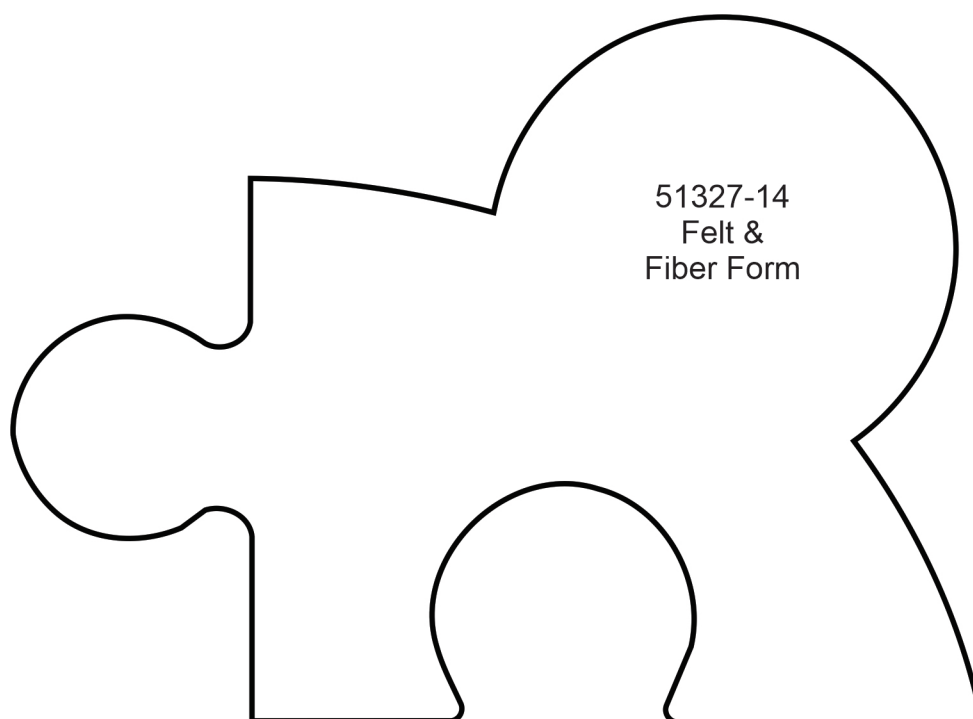

51327-14
Felt &
Fiber Form

APPLIQUE PATTERNS



Print at 100%. No scaling. This box measures 1" x 1". Use the box as an accuracy guide when printing templates.

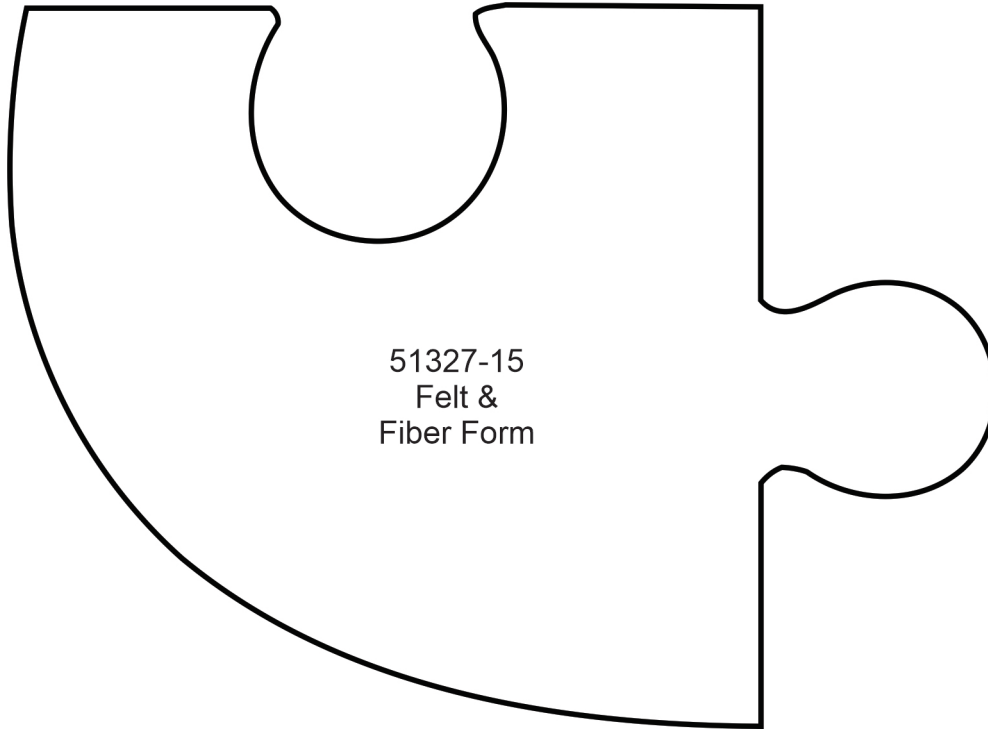

51327-15
Felt &
Fiber Form

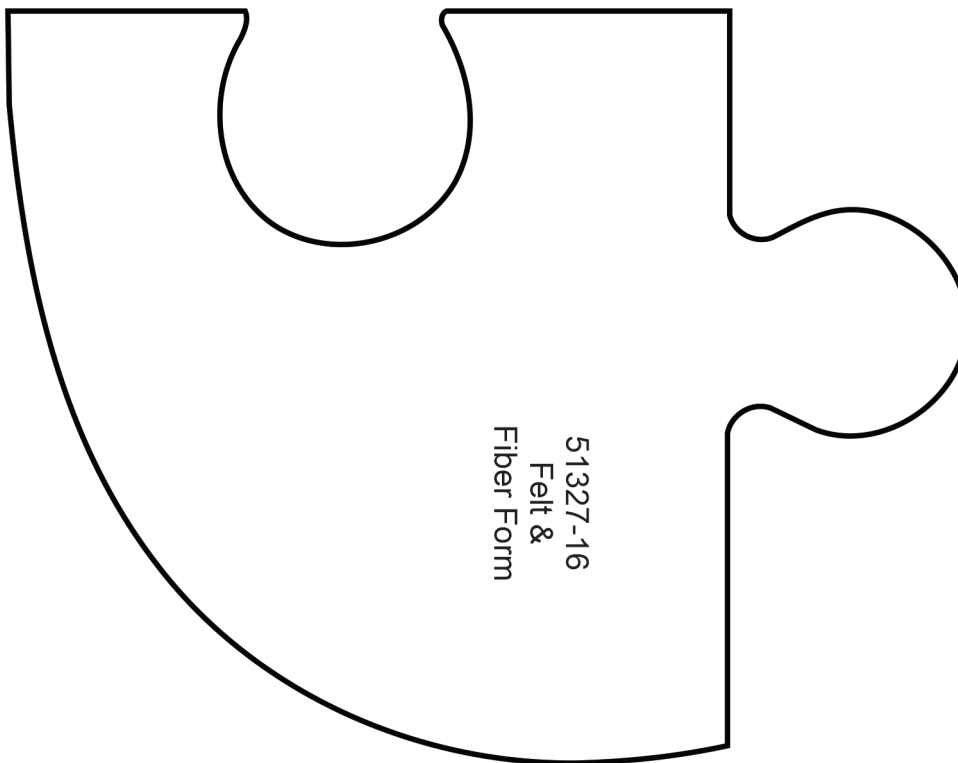

51327-16
Felt &
Fiber Form

MIRRORED PATTERNS

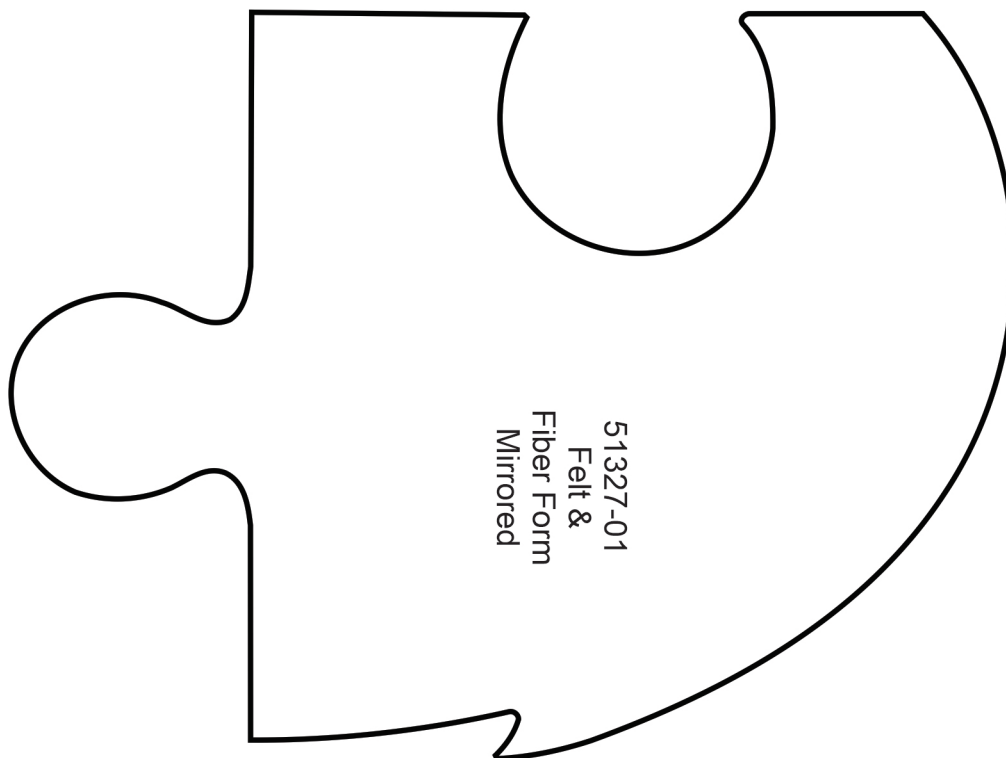

51327-01
Felt &
Fiber Form
Mirrored

Print at 100%. No scaling. This box measures 1" x 1". Use the box as an accuracy guide when printing templates.

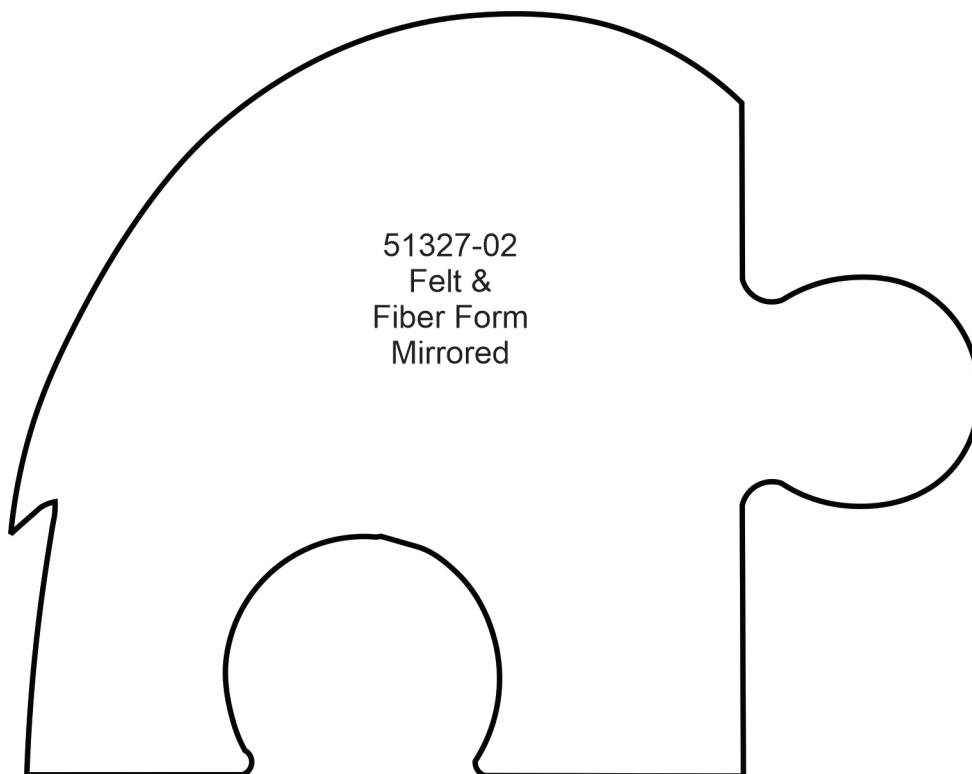

51327-02
Felt &
Fiber Form
Mirrored

MIRRORED PATTERNS



Print at 100%. No scaling. This box measures 1" x 1". Use the box as an accuracy guide when printing templates.

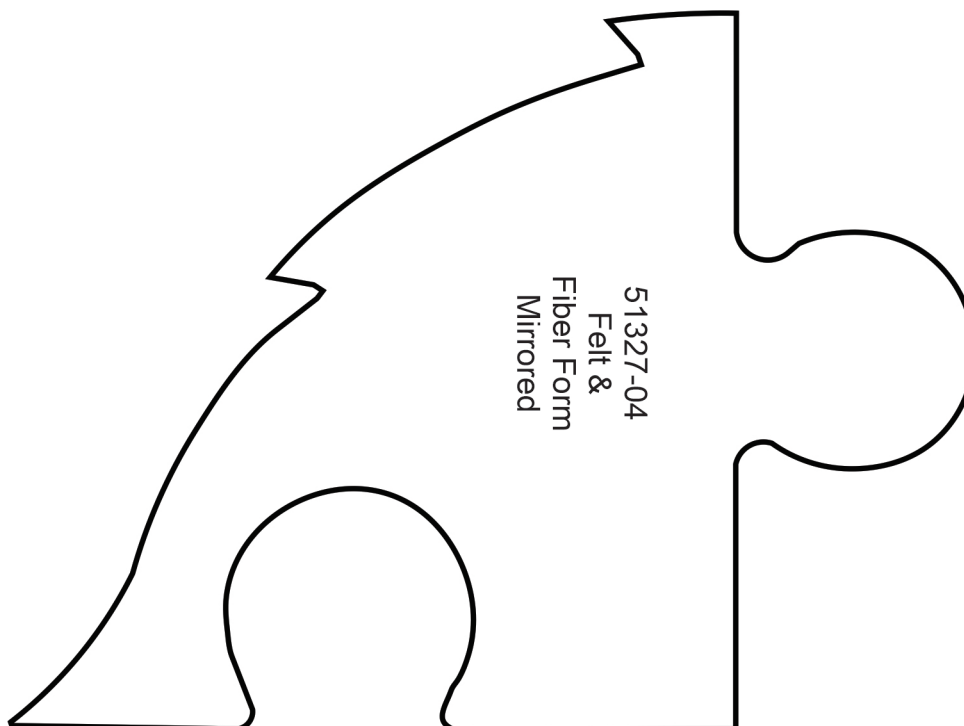
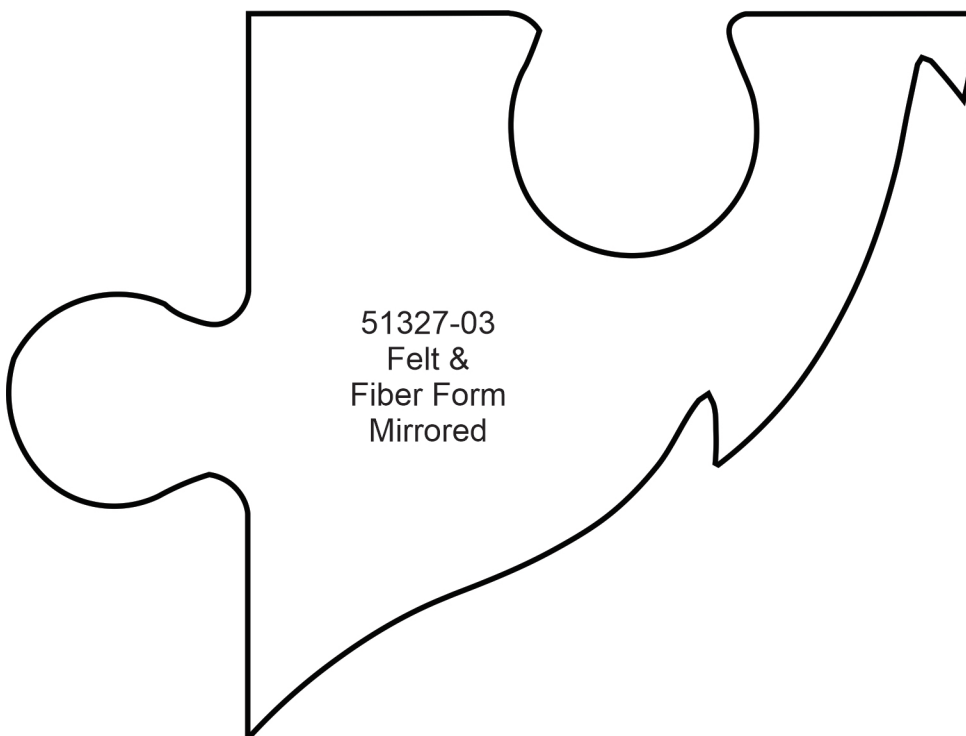

MIRRORED PATTERNS



Print at 100%. No scaling. This box measures 1" x 1". Use the box as an accuracy guide when printing templates.

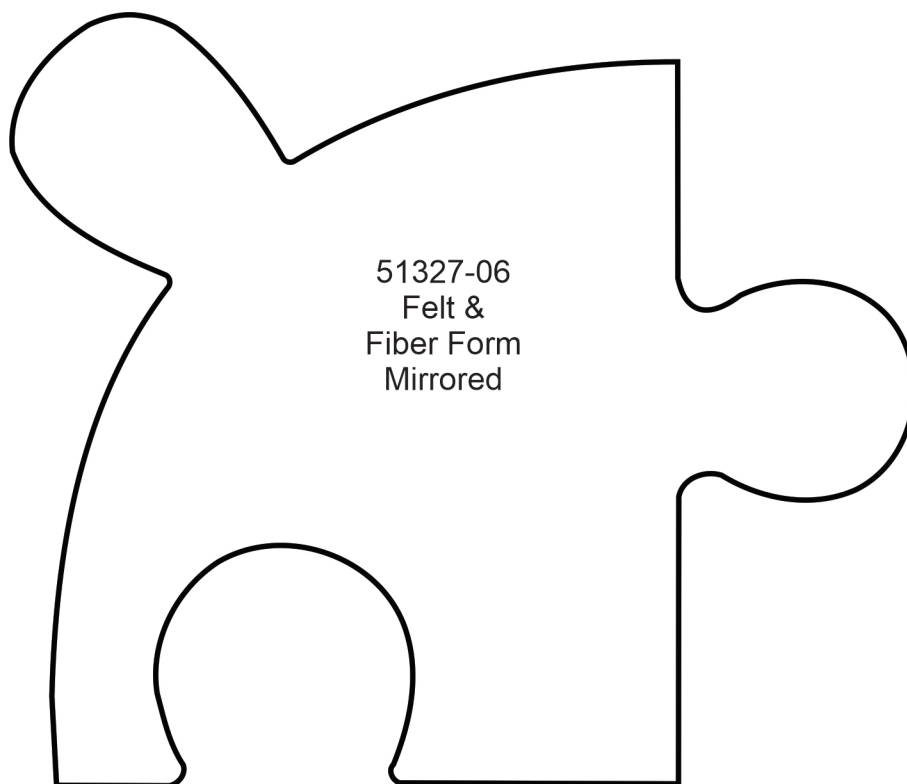
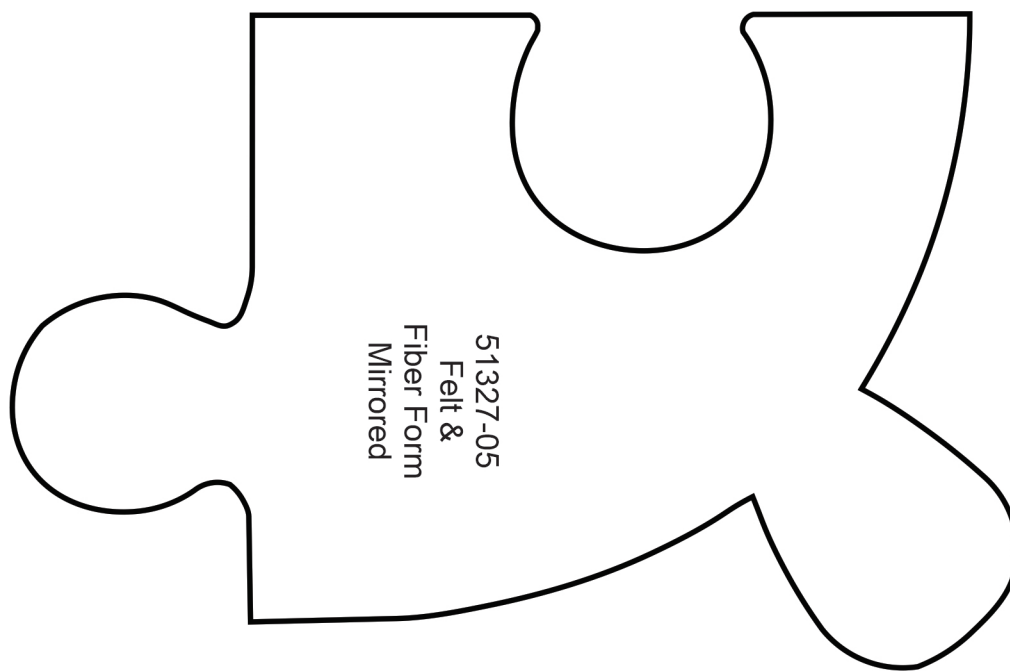

MIRRORED PATTERNS



Print at 100%. No scaling. This box measures 1" x 1". Use the box as an accuracy guide when printing templates.

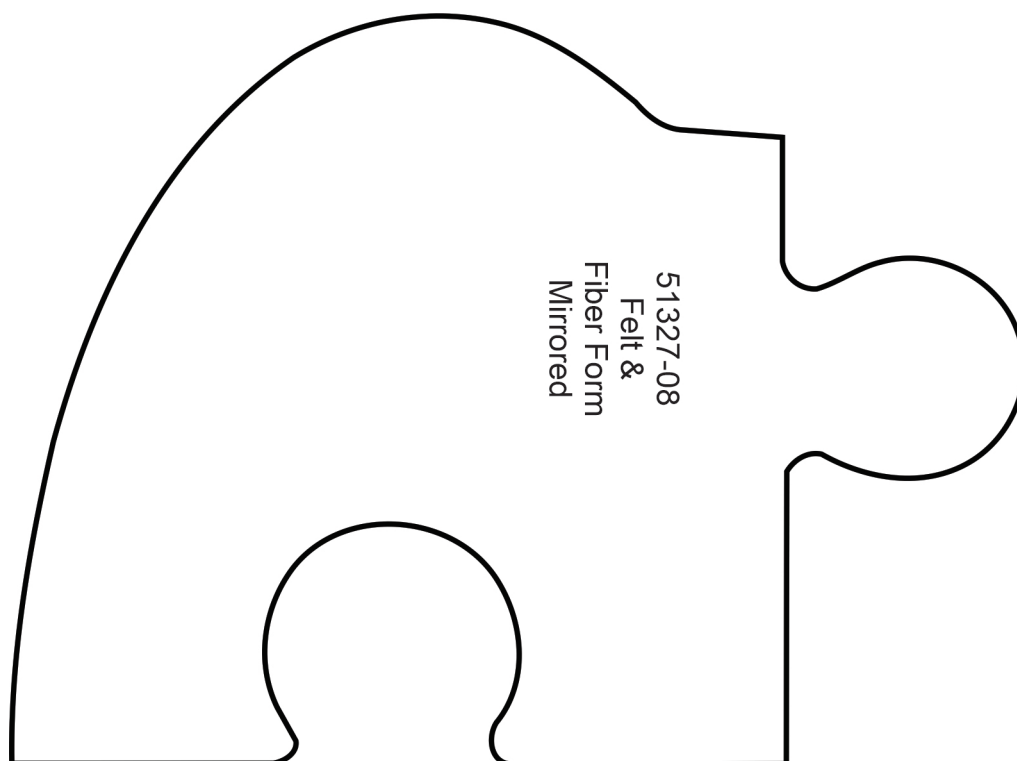
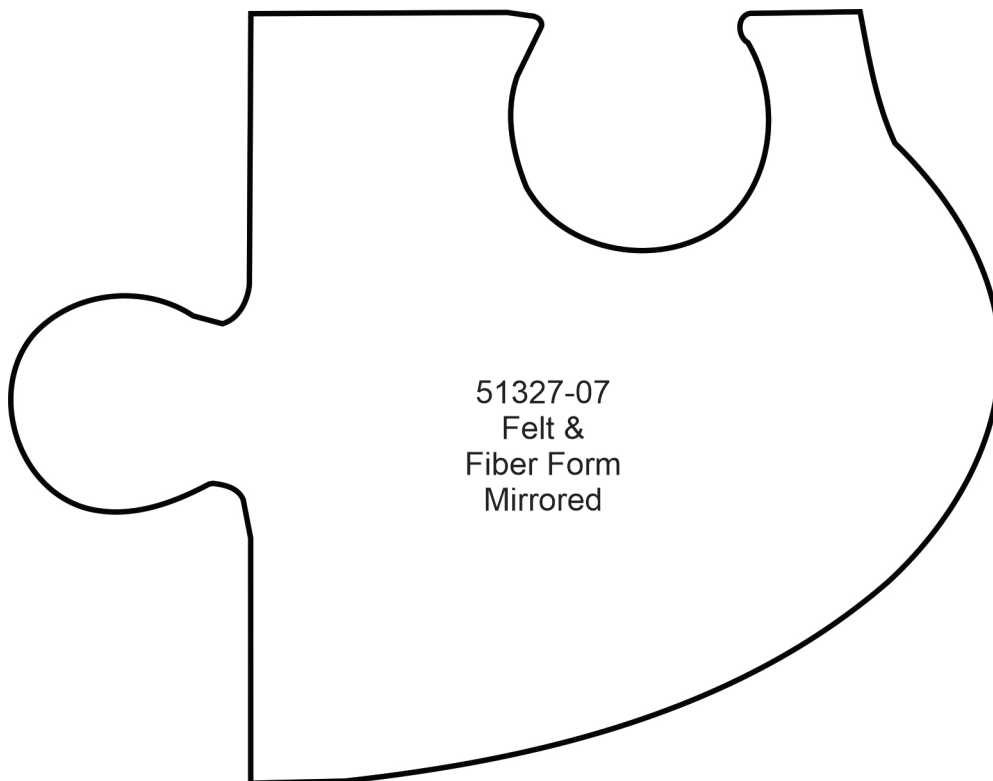

MIRRORED PATTERNS

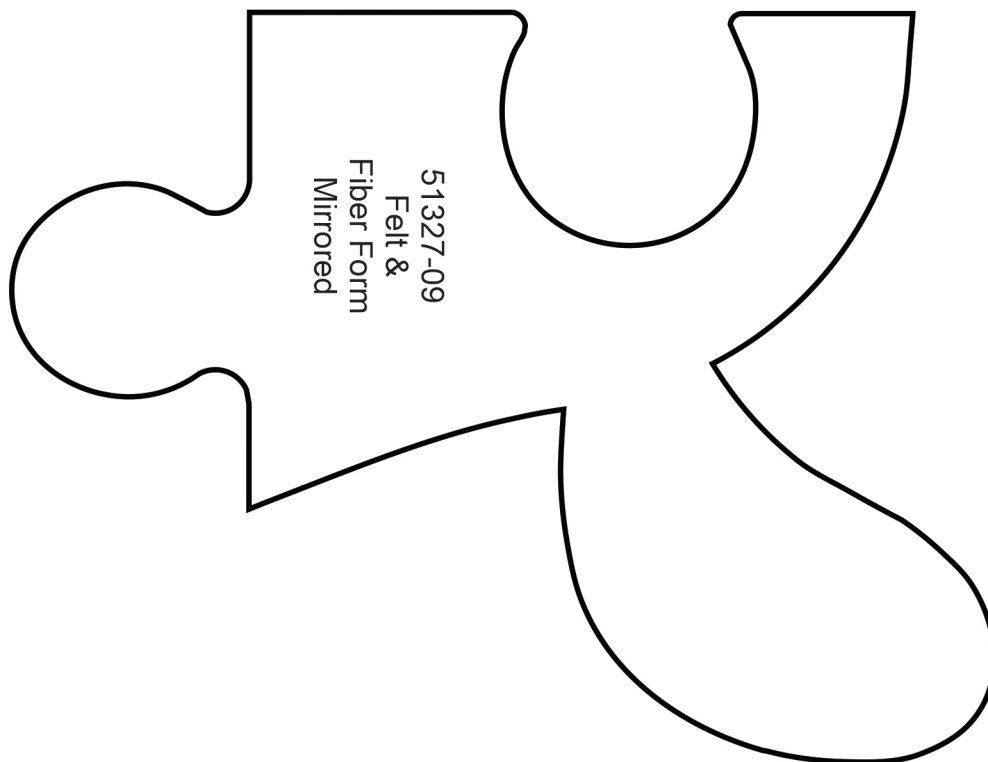

Print at 100%. No scaling. This box measures 1" x 1". Use the box as an accuracy guide when printing templates.

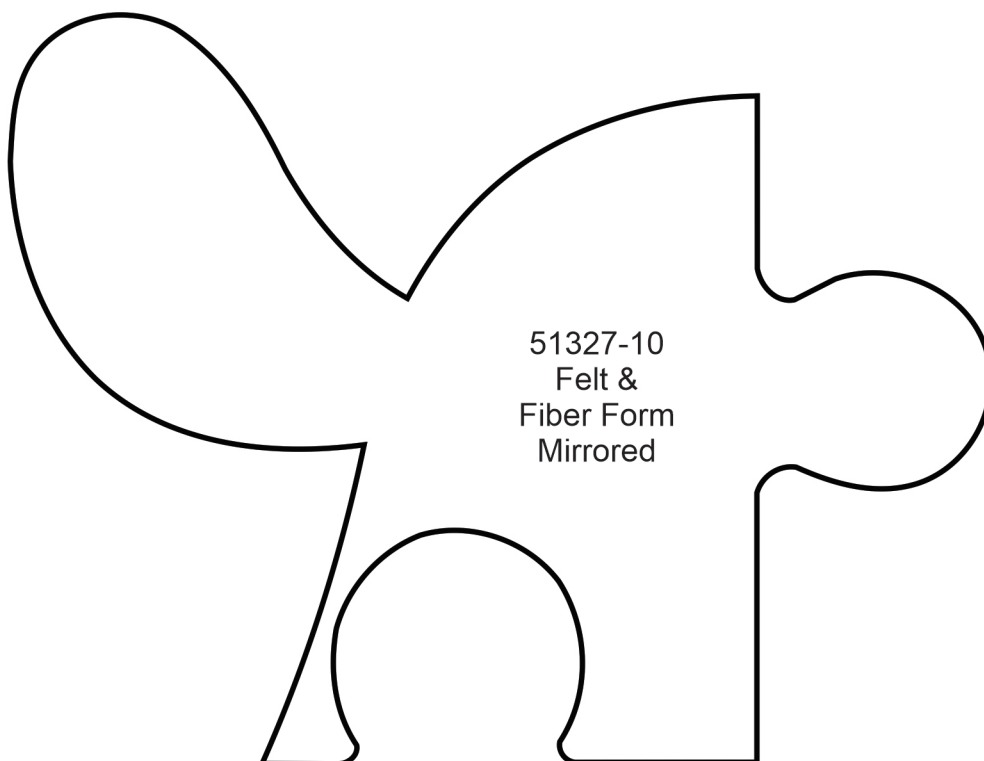

MIRRORED PATTERNS



Print at 100%. No scaling. This box measures 1" x 1". Use the box as an accuracy guide when printing templates.

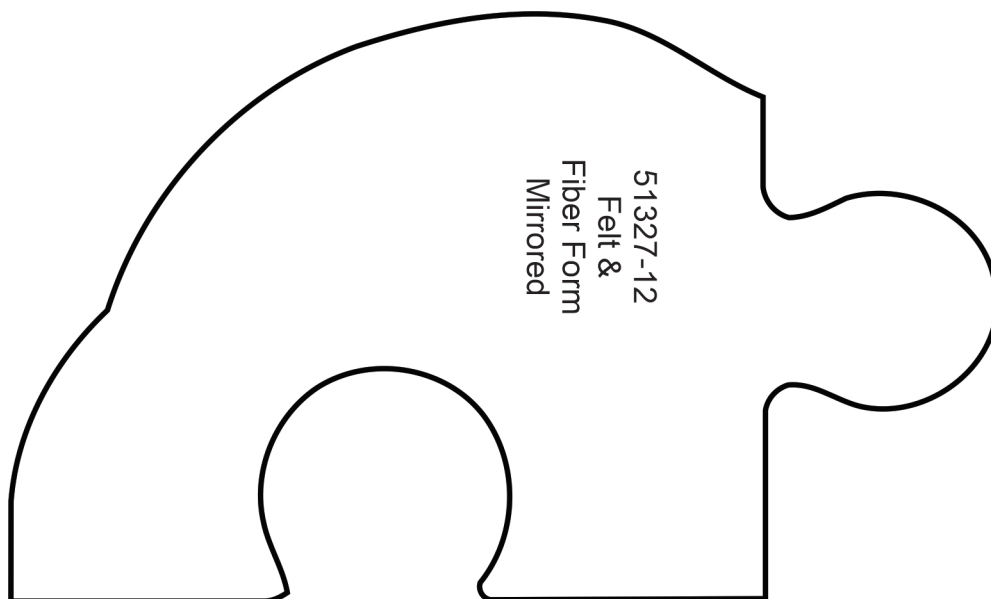
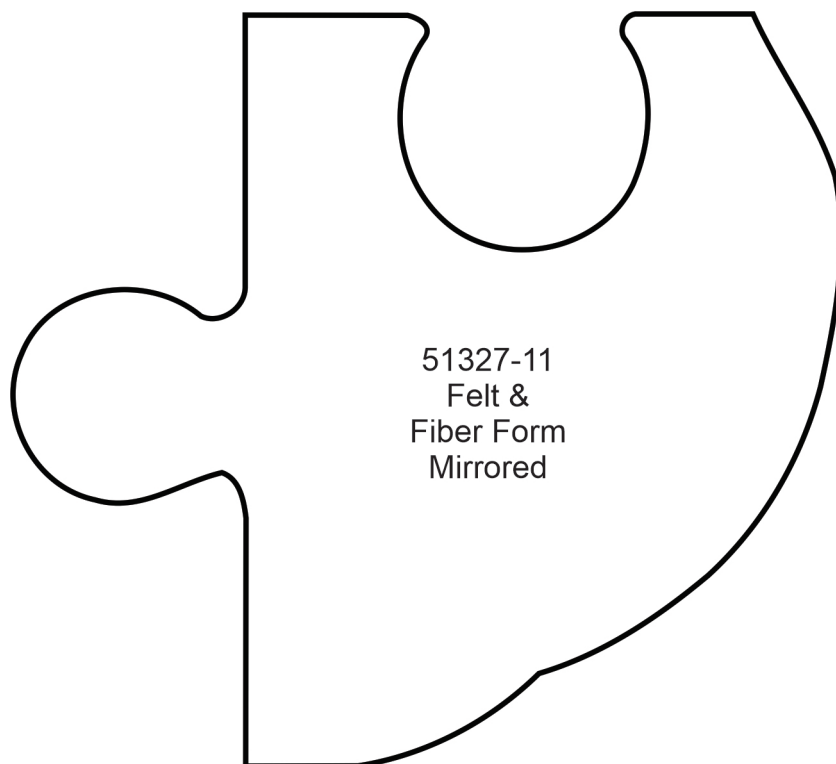

MIRRORED PATTERNS

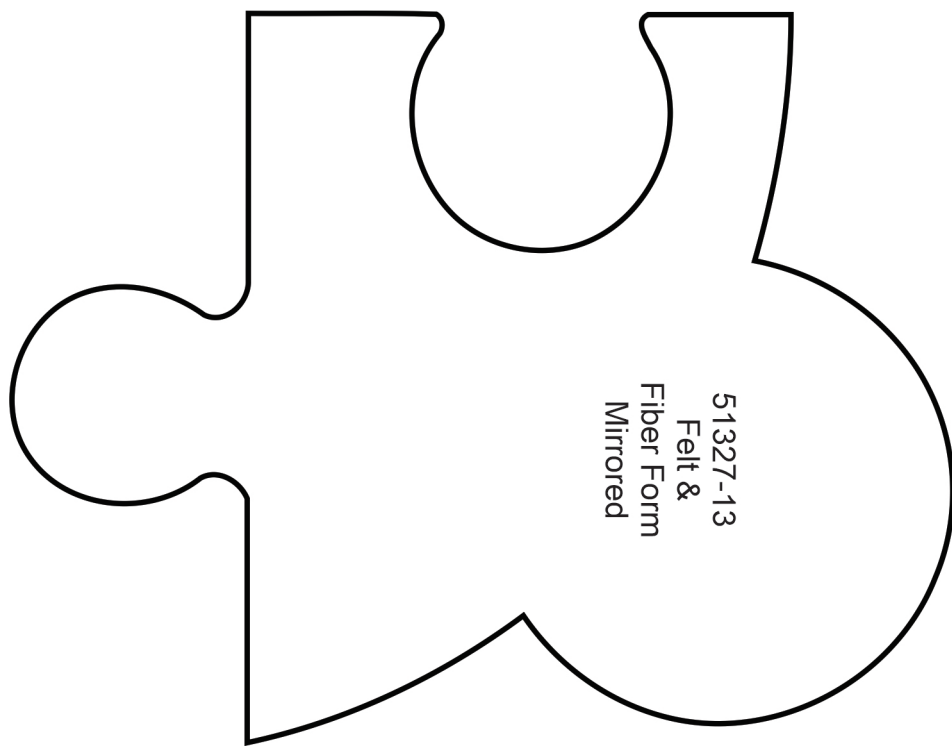

Print at 100%. No scaling. This box measures 1" x 1". Use the box as an accuracy guide when printing templates.

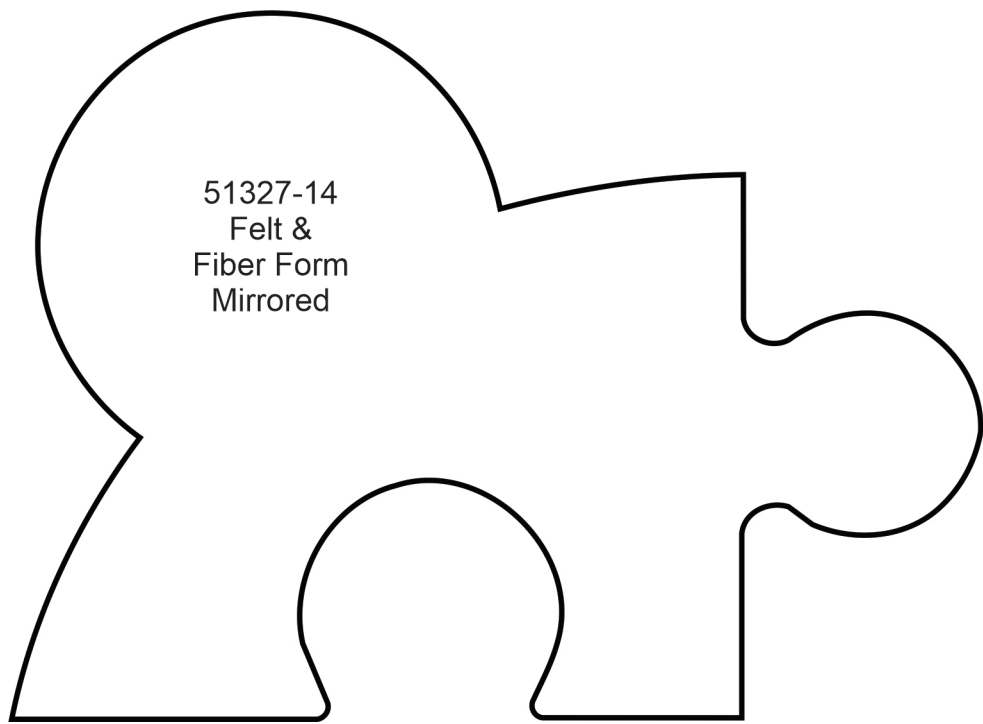

MIRRORED PATTERNS

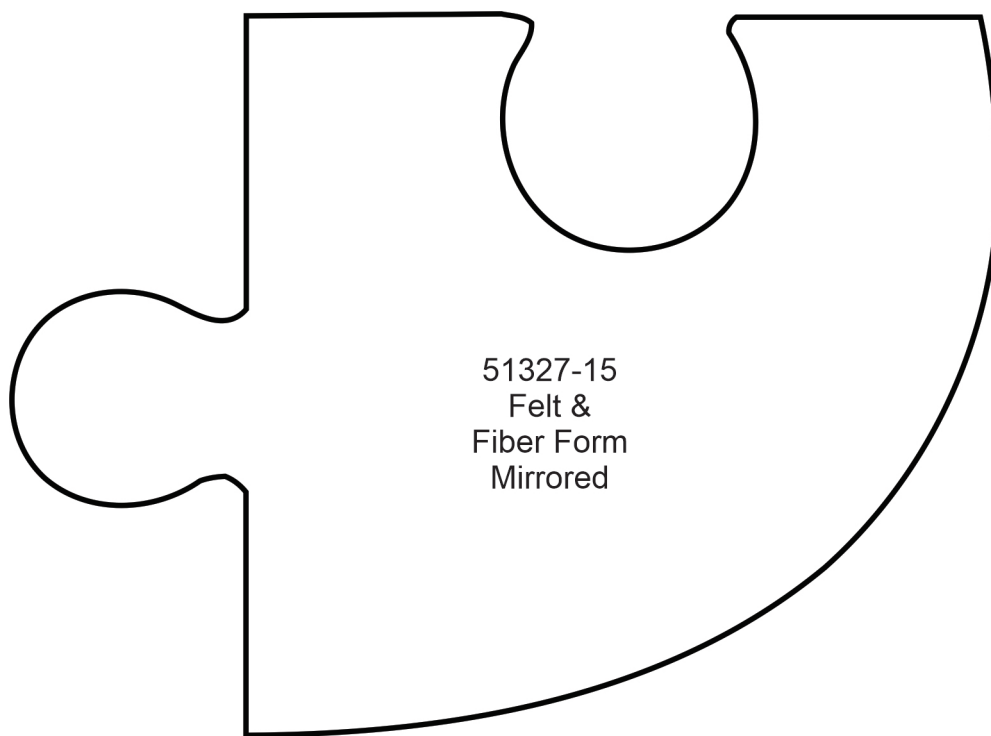

Print at 100%. No scaling. This box measures 1" x 1". Use the box as an accuracy guide when printing templates.

