

HOLIDAY STITCHES

35
Designs

COLLECTION SUPPLIES



Isacord Thread Colors

0010 Silky White
1753 Strawberries N' Cream
1805 Strawberry
2101 Country Red
5100 Green
5210 Trellis Green
5220 Silver Sage

Stabilizer

- OESD StabilStick TearAway

Fabric/Notions

- Red Fabric 1/3 yd
- Green Fabric 1/3 yd

Note: Some designs in this collection may have been created using unique special stitches and/or techniques. To preserve design integrity when rescaling or rotating designs in your software, always rescale or rotate designs using the handles directly on-screen.

*Fabric Required

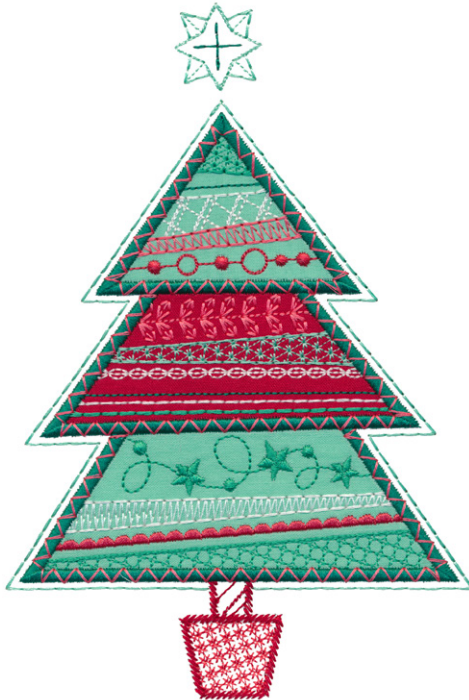

82023-01 Christmas Tree Applique

Size Inches: 7.91 X 5.28 in. Size mm: 200.9 X 134.1 mm Stitch Count: 15740 St.

- 1. Green Fabric Placement Stitch 5210
- 2. Cut Line and Tackdown 5210
- 3. Red Fabric Placement Stitch 5210
- 4. Cut Line and Tackdown 5210
- 5. Medium Green Detail 5210
- 6. Medium Red Detail 1805
- 7. Dark Red Detail 2101
- 8. White Detail 0010
- 9. Light Red Detail 1753
- 10. Light Green Detail 5220
- 11. Dark Green Cover Stitch and Detail 5100
- 12. Light Red Cover Stitch Detail 1753

82023-02 Christmas Tree 1

Size Inches: 8.36 X 4.34 in. Size mm: 212.3 X 110.2 mm Stitch Count: 9224 St.



- 1. Light Green Detail 5220
- 2. Medium Green Detail 5210
- 3. Medium Red Detail 1805
- 4. Dark Red Detail 2101
- 5. Dark Green Detail 5100
- 6. Light Red Detail 1753

Note: Some designs in this collection may have been created using unique special stitches and/or techniques. To preserve design integrity when rescaling or rotating designs in your software, always rescale or rotate designs using the handles directly on-screen.

82023-03 Christmas Tree 2

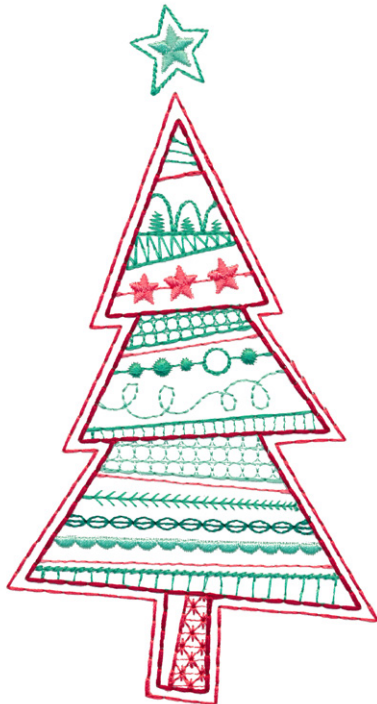

Size Inches: Size mm: Stitch Count:
6.81 X 3.61 in. **173.0 X 91.7 mm** **6387 St.**

- 1. Medium Red Detail..... 1805
- 2. Dark Green Detail..... 5100
- 3. Medium Green Detail 5210
- 4. Light Green Detail 5220
- 5. Light Red Detail..... 1753
- 6. Dark Red Detail 2101

*Fabric Required

82023-04 Ornament Applique



Size Inches: Size mm: Stitch Count:
7.68 X 3.41 in. **195.1 X 86.6 mm** **9822 St.**







- 1. Red Fabric Placement Stitch..... 5210
- 2. Cut Line and Tackdown 5210
- 3. Medium Green Detail 5210
- 4. White Detail..... 0010
- 5. Light Red Detail..... 1753
- 6. Dark Red Detail 2101
- 7. Light Green Detail 5220
- 8. Dark Green Cover Stitch and Detail 5100
- 9. Light Green Cover Stitch Detail..... 5220
- 10. Medium Red Detail..... 1805

Note: Some designs in this collection may have been created using unique special stitches and/or techniques. To preserve design integrity when rescaling or rotating designs in your software, always rescale or rotate designs using the handles directly on-screen.

82023-05 Ornament 1









Size Inches: Size mm: Stitch Count:
6.12 X 3.40 in. **155.4 X 86.4 mm** **5924 St.**

	1. Light Red Detail.....	1753
	2. Medium Green Detail	5210
	3. Light Green Detail	5220
	4. Dark Green Detail.....	5100
	5. Medium Red Detail.....	1805
	6. Dark Red Detail	2101

82023-06 Ornament 2



Size Inches: Size mm: Stitch Count:
6.16 X 2.18 in. **156.5 X 55.4 mm** **4047 St.**

	1. Dark Green Detail.....	5100
	2. Medium Green Detail	5210
	3. Light Red Detail.....	1753
	4. Light Green Detail	5220
	5. Medium Red Detail.....	1805
	6. Dark Red Detail	2101

Note: Some designs in this collection may have been created using unique special stitches and/or techniques. To preserve design integrity when rescaling or rotating designs in your software, always rescale or rotate designs using the handles directly on-screen.

*Fabric Required



82023-07 Ornament Scene Applique

Size Inches: Size mm: Stitch Count:
12.28 X 6.18 in. **311.9 X 157.0 mm** **18396 St.**

- 1. Red Fabric Placement Stitch 5220
- 2. Cut Line and Tackdown 5220
- 3. Light Green Detail 5220
- 4. Medium Green Detail 5210
- 5. Medium Red Detail 1805
- 6. Dark Red Detail 2101
- 7. White Detail 0010
- 8. Light Red Detail 1753
- 9. Dark Green Cover Stitch and Detail 5100
- 10. Medium Green Swirl Detail 5210
- 11. Light Green Cover Stitch Detail 5220

*Fabric Required



82023-08 Stocking Applique

Size Inches: Size mm: Stitch Count:
6.59 X 3.29 in. **167.4 X 83.6 mm** **11640 St.**

- 1. Green Fabric Placement Stitch 5210
- 2. Cut Line and Tackdown 5210
- 3. Medium Green Detail 5210
- 4. White Detail 0010
- 5. Medium Red Detail 1805
- 6. Dark Red Detail 2101
- 7. Light Red Detail 1753
- 8. Dark Green Cover Stitch and Detail 5100
- 9. Light Green Cover Stitch Detail 5220

Note: Some designs in this collection may have been created using unique special stitches and/or techniques. To preserve design integrity when rescaling or rotating designs in your software, always rescale or rotate designs using the handles directly on-screen.

82023-09 Stocking



Size Inches: Size mm: Stitch Count:
5.68 X 2.54 in. **144.3 X 64.5 mm** **5439 St.**

- 1. Light Green Detail 5220
- 2. Medium Green Detail 5210
- 3. Medium Red Detail..... 1805
- 4. Dark Red Detail 2101
- 5. Dark Green Detail..... 5100

*Fabric Required

82023-10 Jingle Bells Applique



Size Inches: Size mm: Stitch Count:
5.52 X 5.25 in. **140.2 X 133.4 mm** **11450 St.**

- 1. Green Fabric Placement Stitch 0010
- 2. Cut Line and Tackdown 0010
- 3. White Detail 0010
- 4. Light Red Detail 1753
- 5. Medium Red Detail 1805
- 6. Medium Green Detail 5210
- 7. Dark Green Cover Stitch and Detail 5100
- 8. Dark Red Cover Stitch and Detail 2101
- 9. Light Green Cover Stitch Detail 5220
- 10. Light Red Cover Stitch Detail 1753
- 11. Medium Green Swirl Detail..... 5210
- 12. Light Green Swirl Detail..... 5220

Note: Some designs in this collection may have been created using unique special stitches and/or techniques. To preserve design integrity when rescaling or rotating designs in your software, always rescale or rotate designs using the handles directly on-screen.

82023-11 Jingle Bell

Size Inches: Size mm: Stitch Count:
2.91 X 2.99 in. **73.9 X 75.9 mm** **4164 St.**

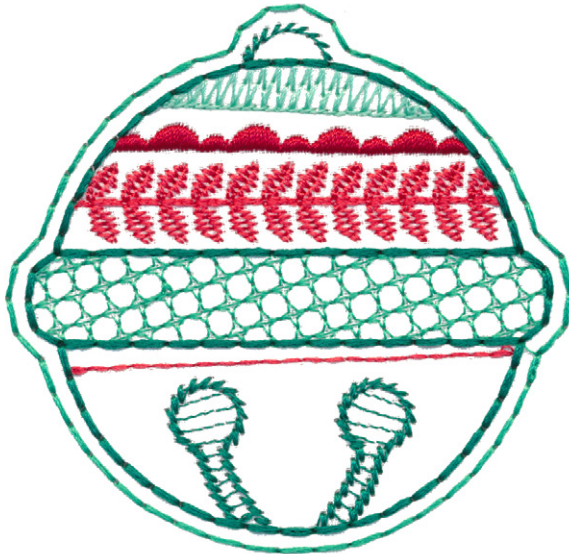

- 1. Medium Red Detail..... 1805
- 2. Dark Red Detail..... 2101
- 3. Light Green Detail 5220
- 4. Medium Green Detail 5210
- 5. Dark Green Detail..... 5100

*Fabric Required

82023-12 Christmas Light Applique

Size Inches: Size mm: Stitch Count:
3.90 X 1.92 in. **99.1 X 48.8 mm** **4905 St.**



- 1. Green Fabric Placement Stitch 0010
- 2. Cut Line and Tackdown 0010
- 3. White Detail..... 0010
- 4. Light Red Detail..... 1753
- 5. Medium Red Detail..... 1805
- 6. Medium Green Detail 5210
- 7. Dark Green Cover Stitch 5100
- 8. Medium Red Cover Stitch 1805
- 9. Light Green Cover Stitch Detail..... 5220

Note: Some designs in this collection may have been created using unique special stitches and/or techniques. To preserve design integrity when rescaling or rotating designs in your software, always rescale or rotate designs using the handles directly on-screen.

82023-13 Christmas Lights

Size Inches: Size mm: Stitch Count:
6.15 X 4.18 in. **156.2 X 106.2 mm** **11458 St.**



	1. Light Green Detail	5220
	2. Light Red Detail	1753
	3. Medium Red Detail	1805
	4. Dark Red Detail	2101
	5. Medium Green Detail	5210
	6. Dark Green Detail	5100

*Fabric Required

82023-14 Holiday Bow Applique

Size Inches: Size mm: Stitch Count:
4.84 X 4.67 in. **122.9 X 118.6 mm** **15058 St.**



	1. Red Fabric Placement Stitch	1753
	2. Cut Line and Tackdown	1753
	3. Light Red Detail	1753
	4. White Detail	0010
	5. Dark Green Detail	5100
	6. Medium Green Detail	5210
	7. Light Green Detail	5220
	8. Dark Red Cover Stitch	2101
	9. Light Red Cover Stitch Detail	1753

Note: Some designs in this collection may have been created using unique special stitches and/or techniques. To preserve design integrity when rescaling or rotating designs in your software, always rescale or rotate designs using the handles directly on-screen.

82023-15 Christmas Present



Size Inches: Size mm: Stitch Count:
5.99 X 4.90 in. **152.1 X 124.5 mm** **9673 St.**

	1. Medium Green Detail	5210
	2. Light Green Detail	5220
	3. Dark Green Detail.....	5100
	4. Medium Red Detail.....	1805
	5. Dark Red Detail	2101
	6. Light Red Detail.....	1753

*Fabric Required

82023-16 Candy Cane Applique



Size Inches: Size mm: Stitch Count:
5.96 X 2.80 in. **151.4 X 71.1 mm** **9303 St.**

	1. Red Fabric Placement Stitch.....	1753
	2. Cut Line and Tackdown	1753
	3. Light Red Detail.....	1753
	4. Dark Green Detail.....	5100
	5. Medium Green Detail	5210
	6. White Detail	0010
	7. Light Green Detail	5220
	8. Dark Red Cover Stitch.....	2101
	9. Light Red Cover Stitch Detail	1753

Note: Some designs in this collection may have been created using unique special stitches and/or techniques. To preserve design integrity when rescaling or rotating designs in your software, always rescale or rotate designs using the handles directly on-screen.

82023-17 Holiday Candle

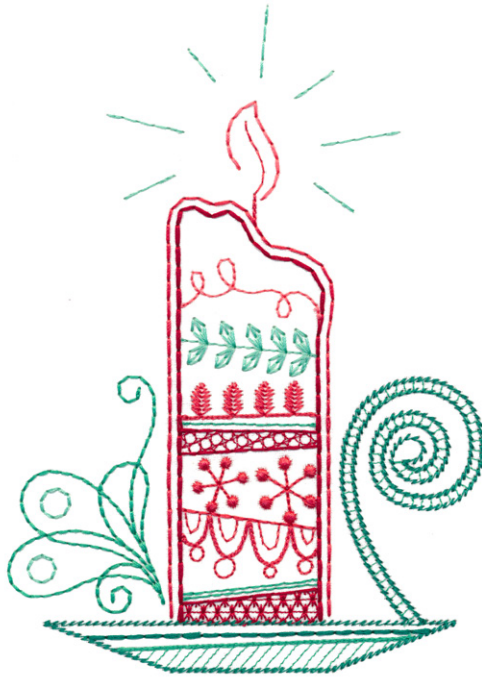

Size Inches: Size mm: Stitch Count:
6.90 X 4.90 in. **175.3 X 124.5 mm** **7110 St.**

- 1. Medium Red Detail..... 1805
- 2. Medium Green Detail 5210
- 3. Light Green Detail 5220
- 4. Dark Green Detail..... 2101
- 5. Light Red Detail..... 1753
- 6. Dark Green Detail..... 5100

*Fabric Required

82023-18 Holiday Wreath Applique



Size Inches: Size mm: Stitch Count:
5.25 X 5.25 in. **133.4 X 133.4 mm** **15949 St.**

- 1. Green Fabric Placement Stitch 1805
- 2. Cut Line and Tackdown 1805
- 3. Red Fabric Placement Stitch..... 1805
- 4. Cut Line and Tackdown 1805
- 5. Medium Red Detail..... 1805
- 6. Medium Green Detail 5210
- 7. Light Red Detail..... 1753
- 8. Light Green Detail 5220
- 9. White Detail..... 0010
- 10. Dark Green Inside Cover Stitch and Detail 5100
- 11. Light Green Inside Cover Stitch Detail 5220
- 12. Dark Red Cover Stitch and Detail 2101
- 13. Light Red Cover Stitch Detail 1753

Note: Some designs in this collection may have been created using unique special stitches and/or techniques. To preserve design integrity when rescaling or rotating designs in your software, always rescale or rotate designs using the handles directly on-screen.

*Fabric Required

82023-19 Holiday Star Applique

Size Inches: Size mm: Stitch Count:
5.40 X 5.41 in. **137.2 X 137.4 mm** **14387 St.**



- 1. Red Fabric Placement Stitch 0010
- 2. Cut Line and Tackdown 0010
- 3. White Detail 0010
- 4. Light Green Detail 5220
- 5. Medium Red Detail 1805
- 6. Light Red Detail 1753
- 7. Medium Green Detail 5210
- 8. Dark Green Inside Cover Stitch and Detail ... 5100
- 9. Dark Red Cover Stitch 2101
- 10. Light Red Cover Stitch Detail 1753
- 11. Light Green Inside Cover Stitch Detail 5220

82023-20 Holiday Star 1

Size Inches: Size mm: Stitch Count:
5.02 X 5.03 in. **127.5 X 127.8 mm** **7368 St.**

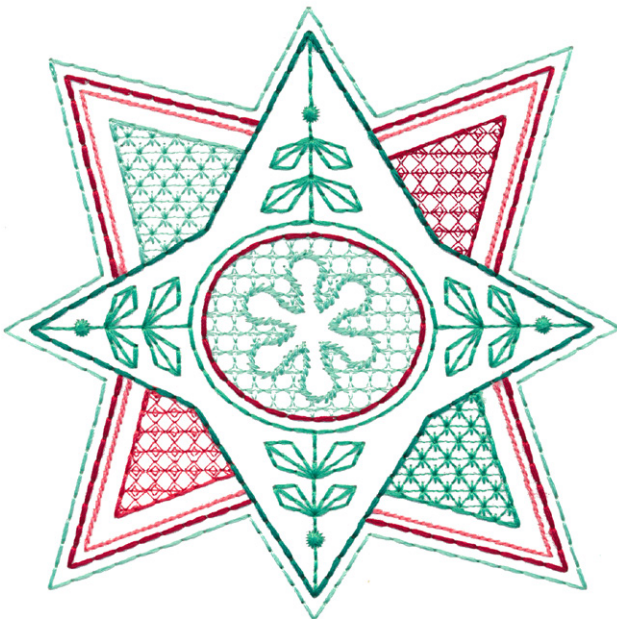

- 1. Medium Green Detail 5210
- 2. Light Green Detail 5220
- 3. Dark Red Detail 2101
- 4. Light Red Detail 1753
- 5. Medium Red Detail 1805
- 6. Dark Green Detail 5100

Note: Some designs in this collection may have been created using unique special stitches and/or techniques. To preserve design integrity when rescaling or rotating designs in your software, always rescale or rotate designs using the handles directly on-screen.

82023-21 Holiday Star 2



Size Inches: Size mm: Stitch Count:
3.55 X 3.49 in. **90.2 X 88.6 mm** **3811 St.**

- 1. Light Green Detail 5220
- 2. Light Red Detail 1753
- 3. Medium Green Detail 5210
- 4. Medium Red Detail 1805
- 5. Dark Green Detail 5100

*Fabric Required

82023-22 Holiday Star Medallion Applique



Size Inches: Size mm: Stitch Count:
5.13 X 5.13 in. **130.3 X 130.3 mm** **15051 St.**







- 1. Green Fabric Placement Stitch 0010
- 2. Cut Line and Tackdown 0010
- 3. White Detail 0010
- 4. Medium Green Detail 5210
- 5. Light Red Detail 1753
- 6. Medium Red Detail 1805
- 7. Light Green Detail 5220
- 8. Dark Red Detail 2101
- 9. Dark Green Cover Stitch 5100
- 10. Light Green Cover Stitch Detail 5220

Note: Some designs in this collection may have been created using unique special stitches and/or techniques. To preserve design integrity when rescaling or rotating designs in your software, always rescale or rotate designs using the handles directly on-screen.

82023-23 Holiday Star Medallion









Size Inches: Size mm: Stitch Count:
 4.47 X 4.47 in. 113.5 X 113.5 mm 9122 St.

	1. Dark Green Detail.....	5100
	2. Medium Red Detail.....	1805
	3. Dark Red Detail.....	2101
	4. Light Green Detail.....	5220
	5. Medium Green Detail.....	5210
	6. Light Red Detail.....	1753

82023-24 Holiday Stars & Holly Vines

Size Inches: Size mm: Stitch Count:
 10.92 X 6.74 in. 277.4 X 171.2 mm 17016 St.



	1. Medium Green Detail.....	5210
	2. Light Green Detail.....	5220
	3. Light Red Detail.....	1753
	4. Medium Red Detail.....	1805
	5. Dark Green Detail.....	5100
	6. Dark Red Detail.....	2101

Note: Some designs in this collection may have been created using unique special stitches and/or techniques. To preserve design integrity when rescaling or rotating designs in your software, always rescale or rotate designs using the handles directly on-screen.

82023-25 Jumbo Holiday Wreath



Size Inches: Size mm: Stitch Count:
9.81 X 9.88 in. **249.2 X 251.0 mm** **35404 St.**

- 1. Medium Green Detail 5210
- 2. Light Green Detail 5220
- 3. Medium Red Detail..... 1805
- 4. Light Red Detail..... 1753

82023-26 Holiday Stitches Medallion

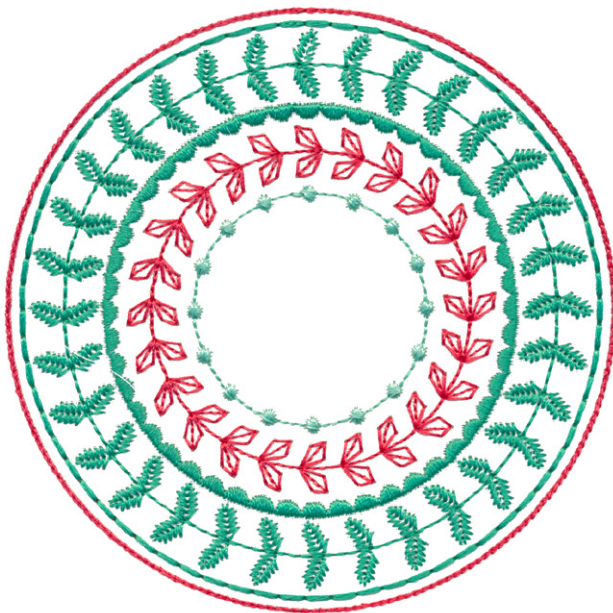

Size Inches: Size mm: Stitch Count:
4.53 X 4.53 in. **115.1 X 115.1 mm** **9997 St.**

- 1. Light Green Detail 5220
- 2. Medium Green Detail 5210
- 3. Red Detail..... 1805

Note: Some designs in this collection may have been created using unique special stitches and/or techniques. To preserve design integrity when rescaling or rotating designs in your software, always rescale or rotate designs using the handles directly on-screen.

82023-27 Holiday Stitches 1

Size Inches: Size mm: Stitch Count:
6.38 X 3.16 in. **162.1 X 79.7 mm** **5916 St.**

- 1. Medium Green Detail 5210
- 2. Light Green Detail 5220
- 3. Red Detail..... 1805



82023-28 Holiday Stitches 2

Size Inches: Size mm: Stitch Count:
4.84 X 2.74 in. **122.9 X 69.6 mm** **4598 St.**

- 1. Medium Green Detail 5210
- 2. Red Detail..... 1805
- 3. Light Green Detail 5220





Note: Some designs in this collection may have been created using unique special stitches and/or techniques. To preserve design integrity when rescaling or rotating designs in your software, always rescale or rotate designs using the handles directly on-screen.

82023-29 Holiday Stitches 3

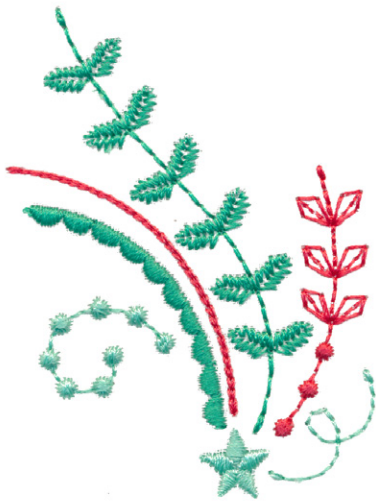
Size Inches: Size mm: Stitch Count:
3.04 X 2.09 in. **77.2 X 53.1 mm** **2332 St.**





	1. Light Green Detail	5220
	2. Medium Green Detail	5210
	3. Red Detail.....	1805

82023-30 Holiday Stitches Corner

Size Inches: Size mm: Stitch Count:
6.11 X 3.23 in. **155.2 X 82.0 mm** **5652 St.**



	1. Medium Green Detail	5210
	2. Red Detail.....	1805
	3. Light Green Detail	5220

Note: Some designs in this collection may have been created using unique special stitches and/or techniques. To preserve design integrity when rescaling or rotating designs in your software, always rescale or rotate designs using the handles directly on-screen.

82023-31 Holiday Swirls Medallion

Size Inches: Size mm: Stitch Count:
 4.57 X 4.57 in. 116.1 X 116.1 mm 6407 St.

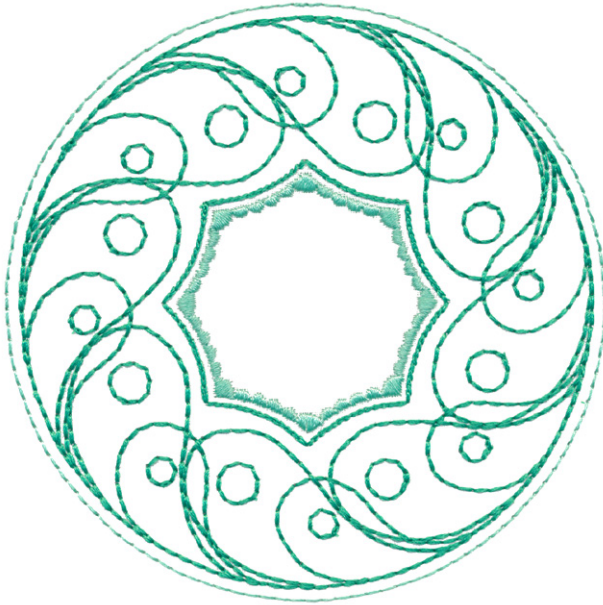

- 1. Medium Green Detail 5210
- 2. Light Green Detail 5220

82023-32 Holiday Swirls 1

Size Inches: Size mm: Stitch Count:
 3.27 X 3.86 in. 83.1 X 98.0 mm 3781 St.

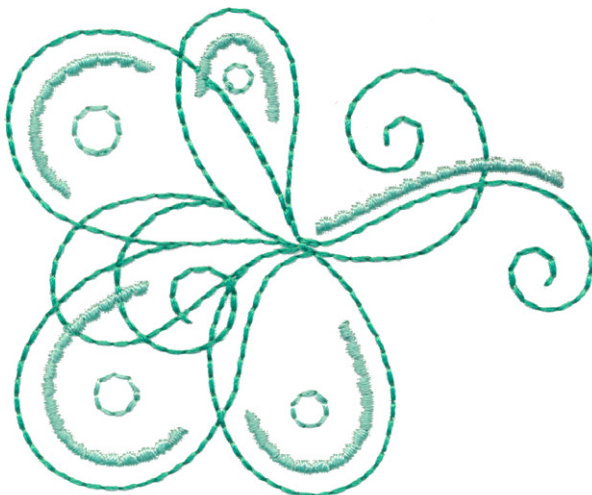

- 1. Medium Green Detail 5210
- 2. Light Green Detail 5220

Note: Some designs in this collection may have been created using unique special stitches and/or techniques. To preserve design integrity when rescaling or rotating designs in your software, always rescale or rotate designs using the handles directly on-screen.

82023-33 Holiday Swirls 2



Size Inches:	Size mm:	Stitch Count:
6.21 X 3.79 in.	157.7 X 96.3 mm	4148 St.

- 1. Medium Green Detail 5210
- 2. Light Green Detail 5220

82023-34 Holiday Swirls Border

Size Inches:	Size mm:	Stitch Count:
6.56 X 2.27 in.	166.6 X 57.7 mm	6261 St.



- 1. Medium Green Detail 5210
- 2. Light Green Detail 5220

Note: Some designs in this collection may have been created using unique special stitches and/or techniques. To preserve design integrity when rescaling or rotating designs in your software, always rescale or rotate designs using the handles directly on-screen.

82023-35 Holiday Swirls Corner

Size Inches:	Size mm:	Stitch Count:
3.13 X 3.63 in.	79.5 X 92.2 mm	3179 St.

- 1. Medium Green Detail 5210
- 2. Light Green Detail 5220

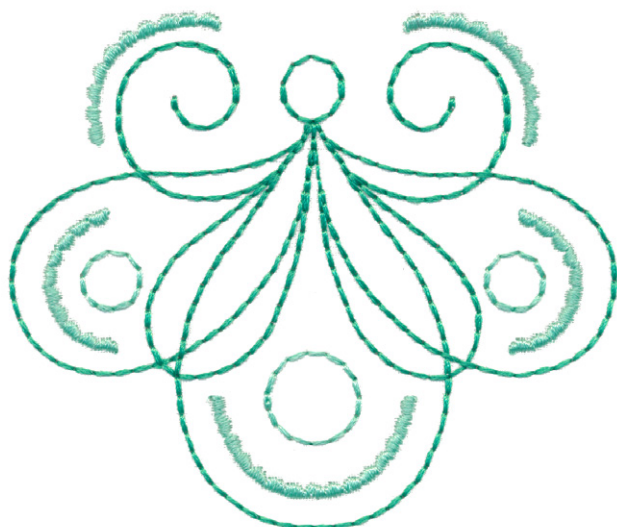

EMBROIDERY



STEP 1

- Prep all Applique fabrics with one layer of StabilStick TearAway.

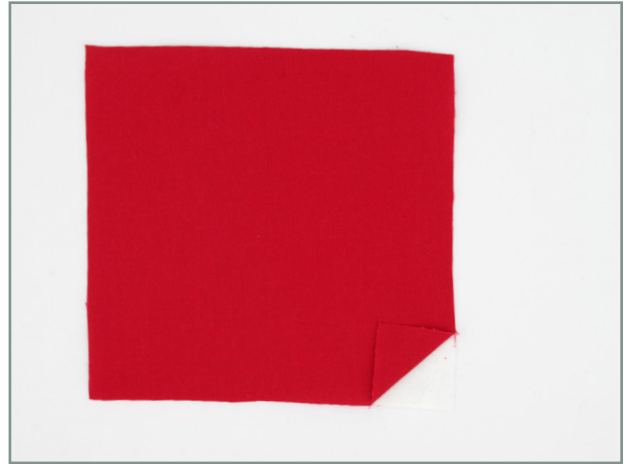

STEP 2

- Hoop desired fabric and stabilizer and stitch color 1, Red Fabric Placement Stitch.



STEP 3

- Lightly spray temporary adhesive to the back side of the applique fabric and place over the placement stitch, covering it completely. Stitch color 2, Cut Line and Tackdown.

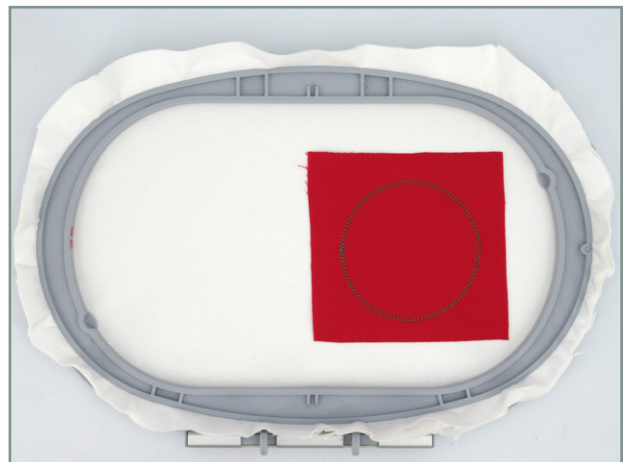

EMBROIDERY



STEP 4

- Remove the hoop from the machine and trim fabric along the cut line.

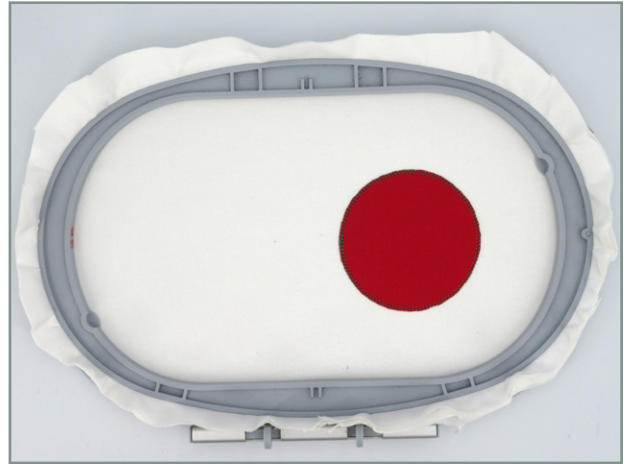

STEP 5

- Replace the hoop to the machine and repeat steps 2-4 for any remaining applique pieces. Continue to stitch out the remaining colors.
- **Note:** Trim between color changes or turn on auto trim machine functions.

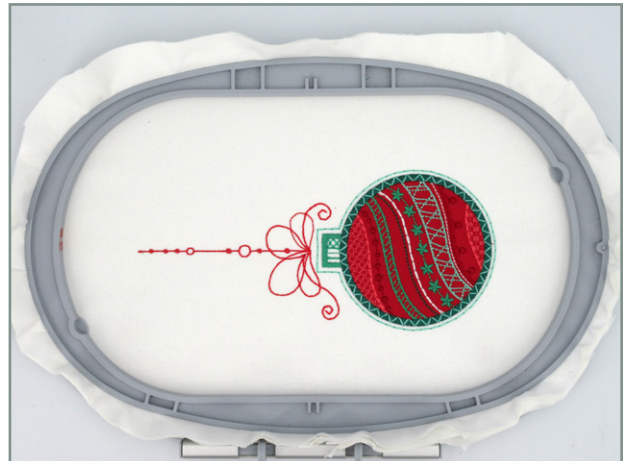

APPLIQUE PATTERNS

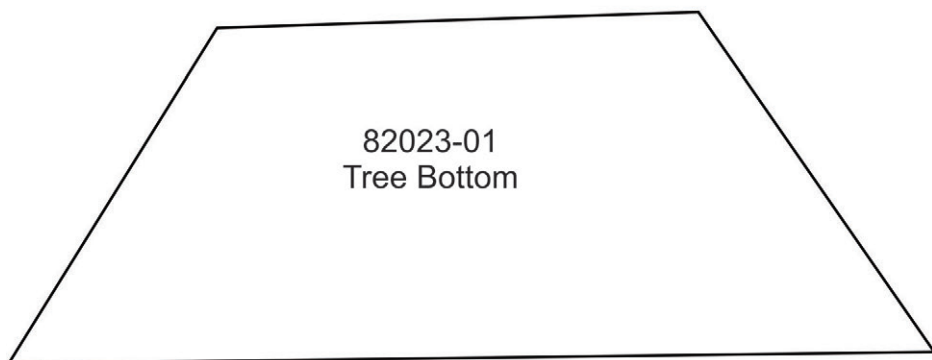
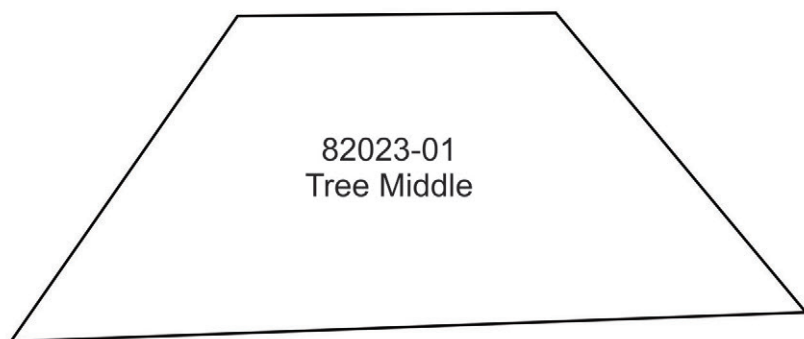
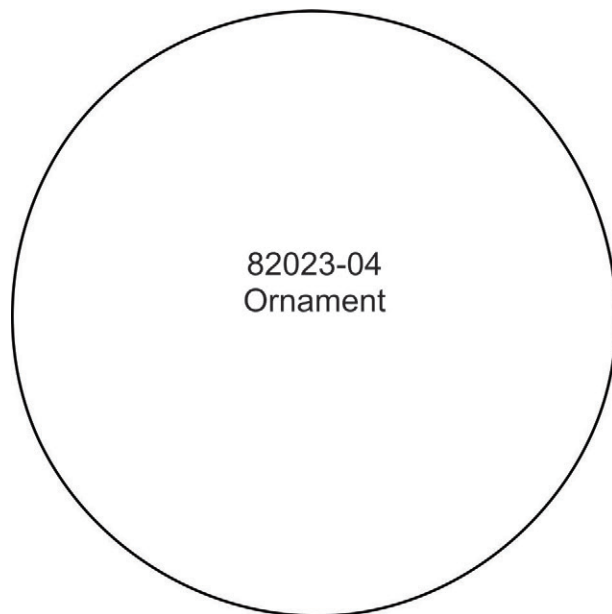
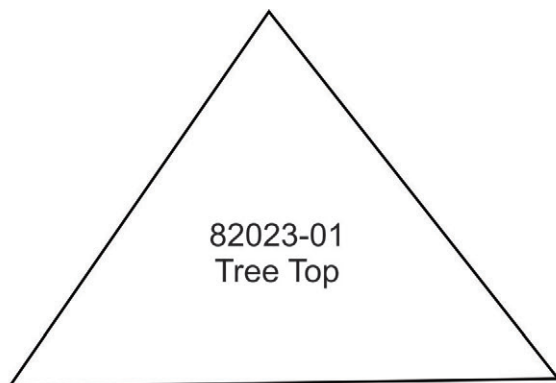

APPLIQUE PATTERNS

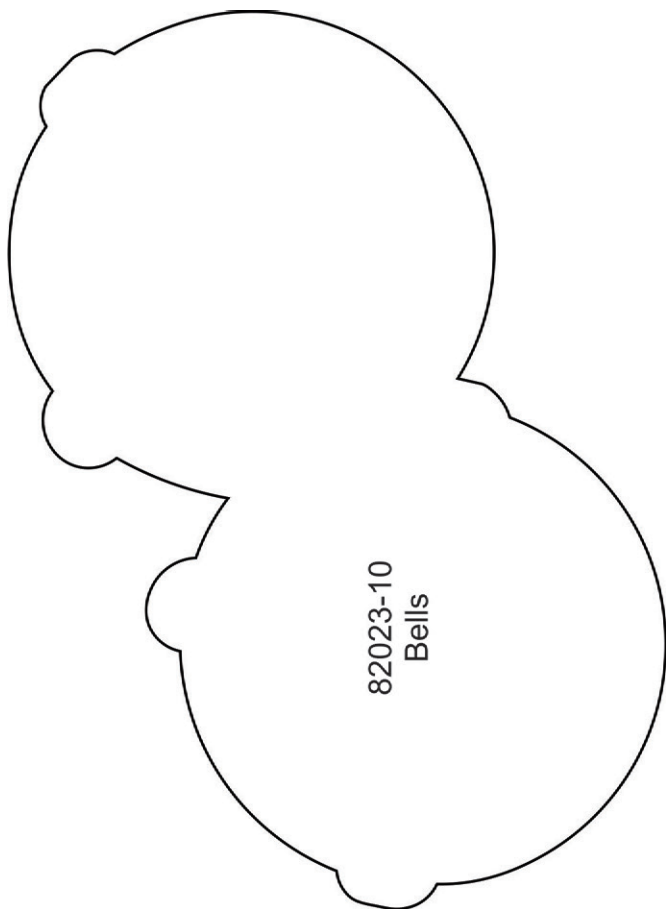
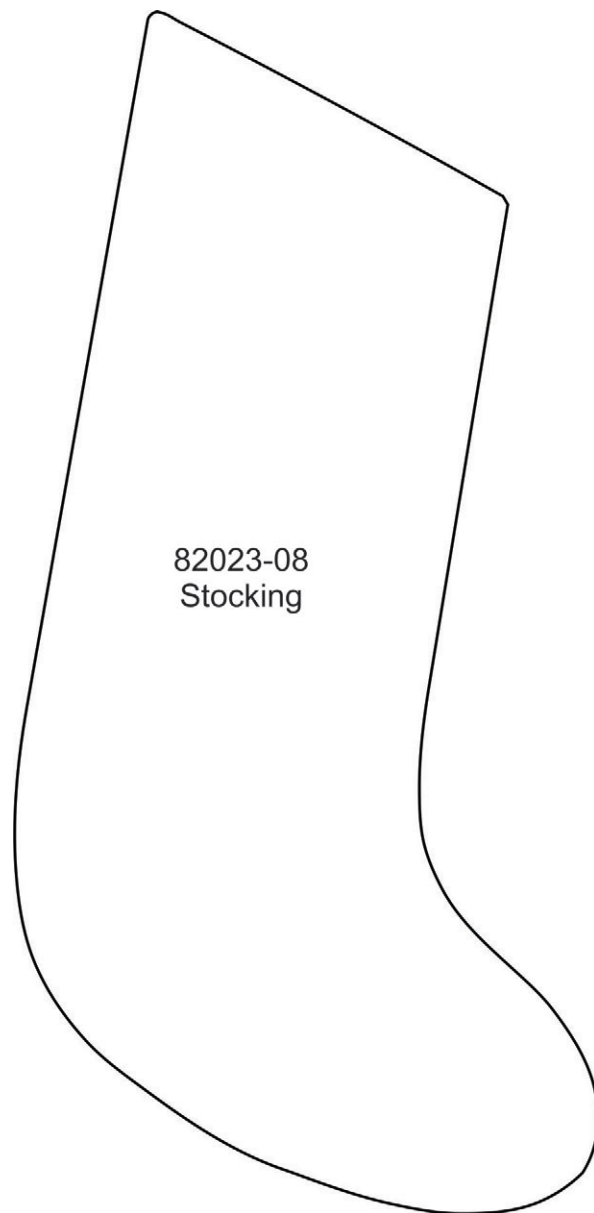
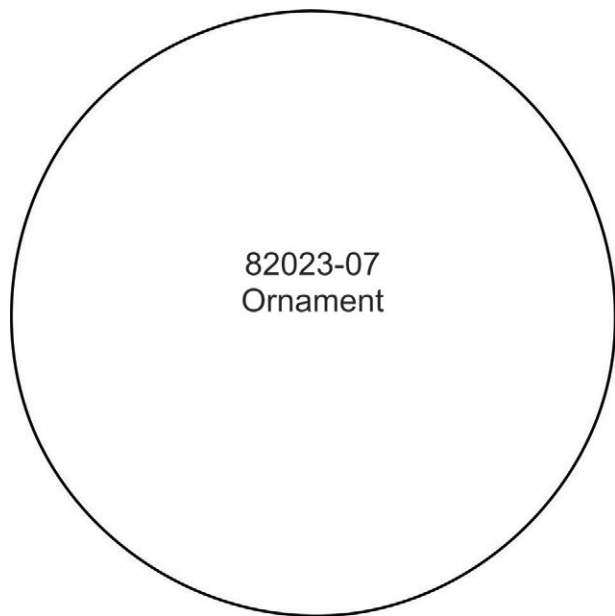

APPLIQUE PATTERNS

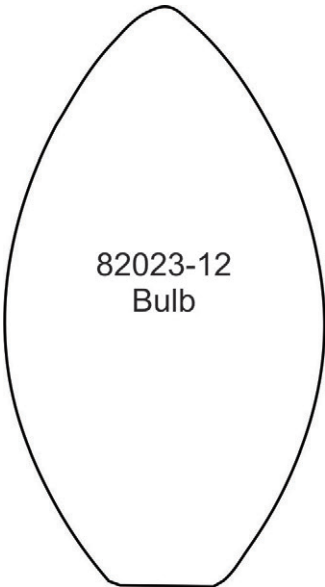

82023-12
Bulb

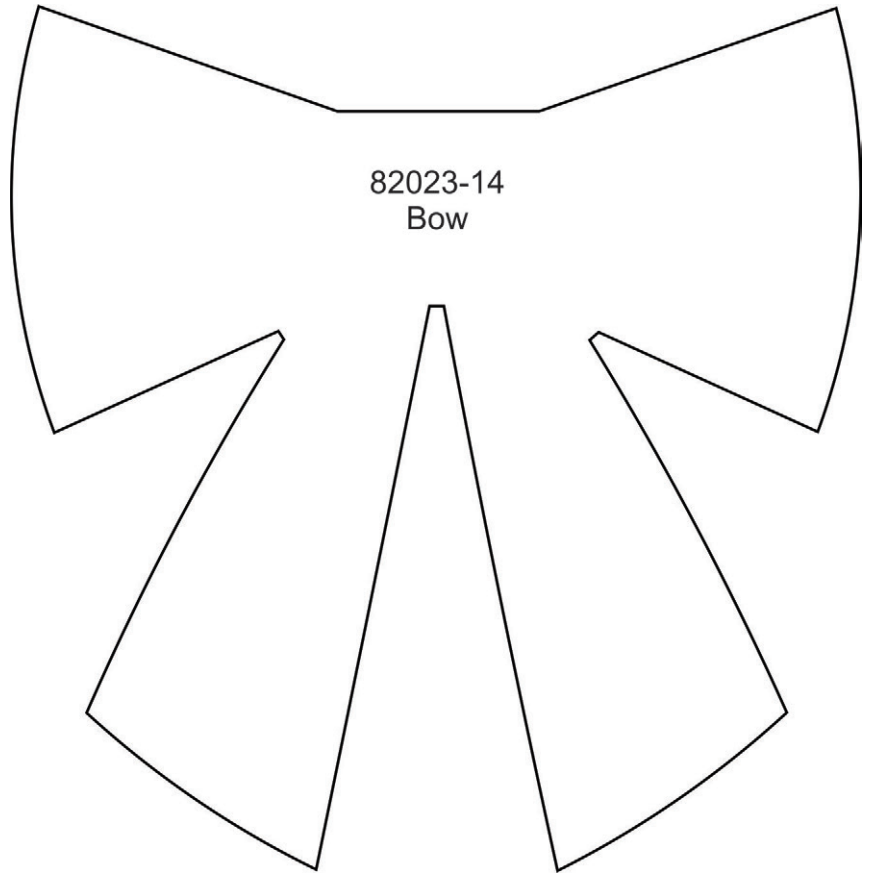

82023-14
Bow

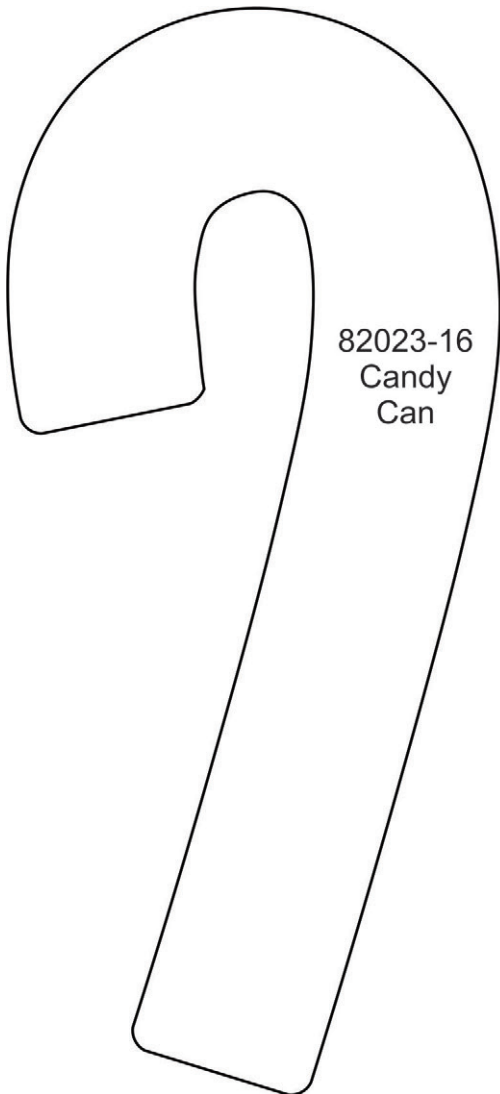

82023-16
Candy
Can

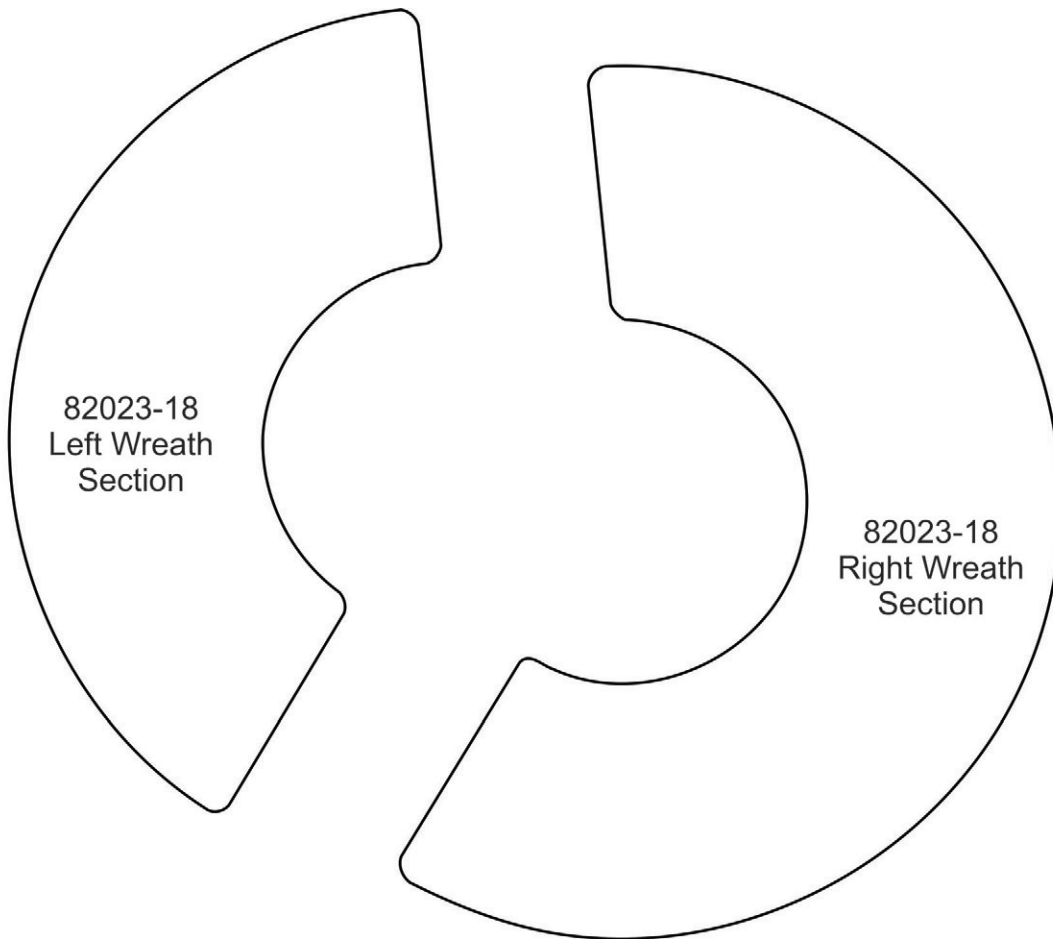

APPLIQUE PATTERNS

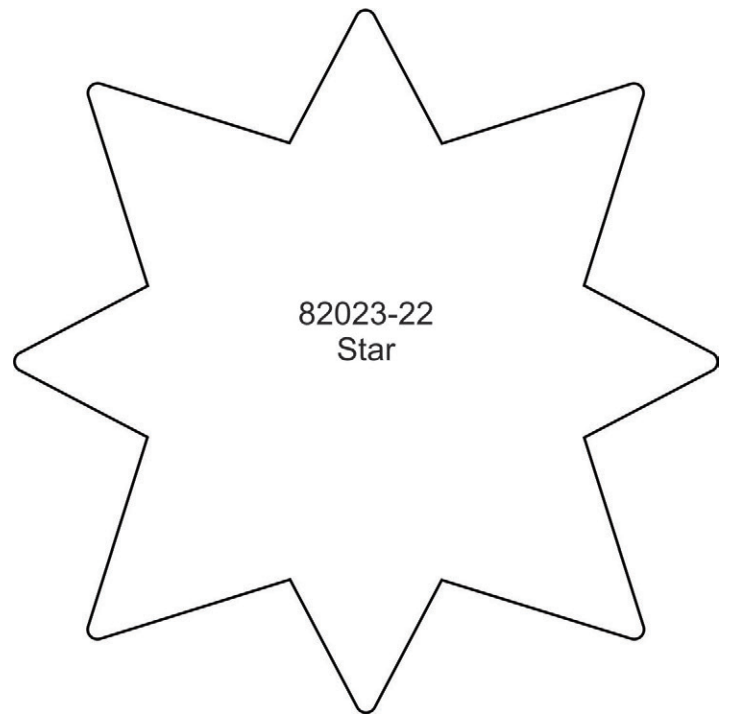
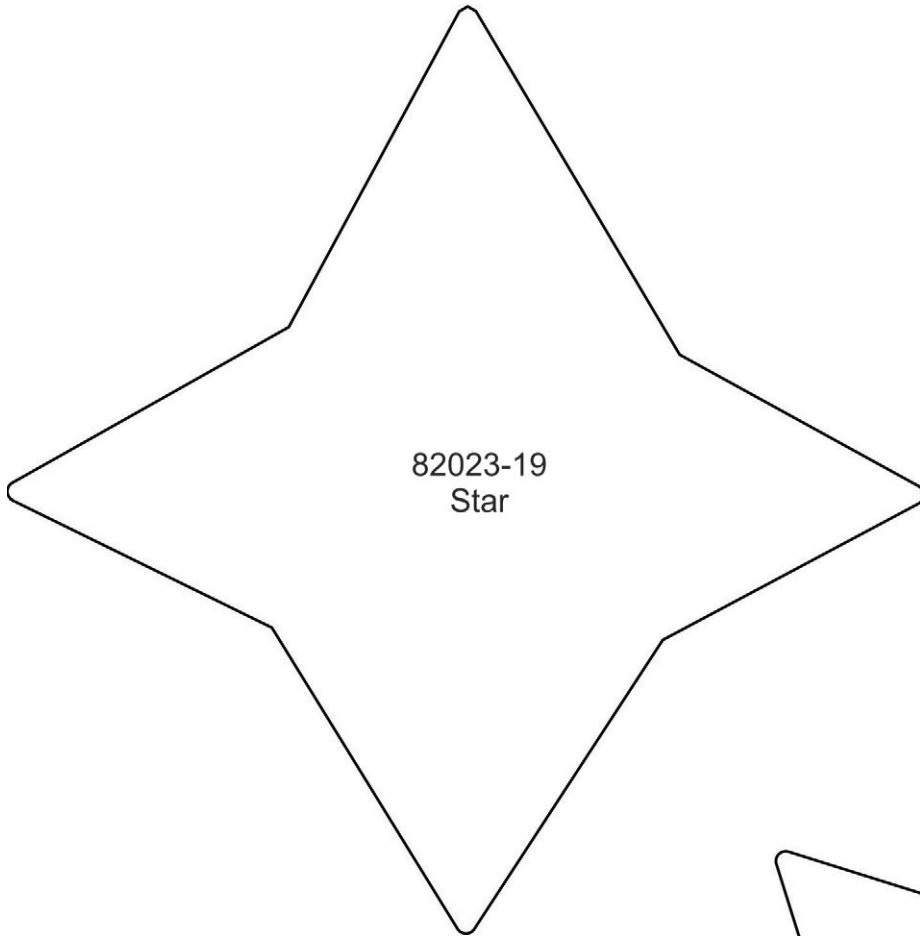

OCTAGON TREE SKIRT



Decorating the Christmas tree isn't complete until it puts on a skirt! Tree skirts are the perfect canvas for showing off your embroidery skills. This project, featuring designs from Holiday Stitches, is a perfect way to dress up your tree. The whimsical stitches and fun colors give the project a modern aesthetic with a nod to traditional hand embroidery. With the help of Pinpoint Placement and large hoops, this is a quick project that requires minimal sewing skills. Enjoy this fun project you'll use for years to come.



PROJECT SUPPLIES



Isacord Thread Colors

Isacord threads per design chart

Stabilizer

- OESD Fusible Woven
- OESD Fuse and Fleece
- OESD StabilStick Template Sheet (optional)
- Heat2Go or StitchH2O topper (recommended)

Fabric/Notions

- 1 yard linen fabric (trimmed to 36" square)
- 1 yard backing fabric (trimmed to 36" square)
- OESD Expert Point and Press Tool (optional)
- Hoops to accommodate design sizes
- Fabric marker
- Ruler, minimum 15" long
- Fabric shears

Designs

- 82023-13 Christmas Lights size 6.15" x 4.18"
- 82023-25 Jumbo Holiday Wreath size 9.81" x 9.88"



INSTRUCTIONS



STEP 1

- Press top fabric with spray starch.
- Apply Fusible Woven to entire back of fabric according to package directions.
- Overlap Fusible Woven by 1/8" when necessary.



STEP 2

- Fold the fabric in half wrong sides together. Press the fold to make a crease.
- Fold in half again, making a square as shown in the diagram. Press the folds to make a crease.
- Take the top folded layer at the corner with two raw edges (top right in the diagram) and fold it to the opposite corner. Press the fold to crease.

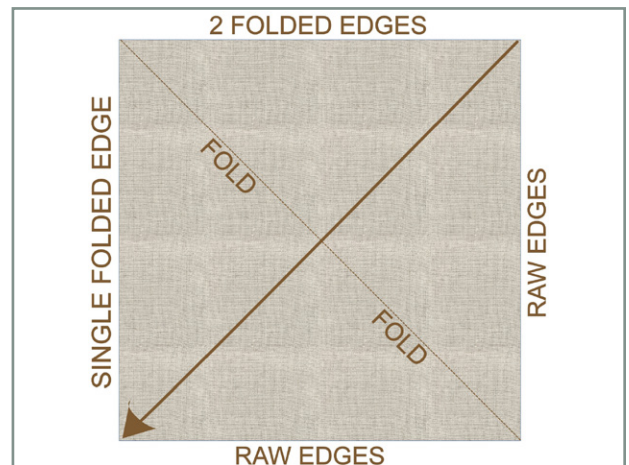

STEP 3

- Flip the fabric over to the other side and fold the remaining folded/raw edge corner together to the opposite corner. Press the fold to crease. This should result in one large triangle.
- The center point of the fabric should look like the image.



INSTRUCTIONS



STEP 4

- From the center point measure down 15" on each fold. Mark as shown.

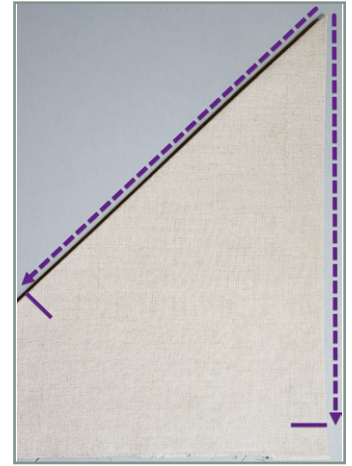

STEP 5

- Mark a line connecting the two points at the fold as shown.



STEP 6

- Repeat Steps 4 and 5 for each of the eight segments of the fabric. The lines should connect as shown.



INSTRUCTIONS



STEP 7

- Trim away the excess fabric in each section to create an octagon.
- For best results, trim one layer of fabric at a time.



STEP 8

- Cut strips of Fuse and Fleece stabilizer 32" long. The number of strips will depend on the width of the Fuse and Fleece.
- Apply the Fuse and Fleece to the back of the fabric following the package instructions.
- A Teflon pressing sheet may be helpful to avoid fusing the stabilizer to the ironing board.
- The Fuse and Fleece should extend beyond the edge of the fabric as shown. Do not trim away the excess. It will act as an extension of the fabric (like a lead cloth), if needed, when hooping.

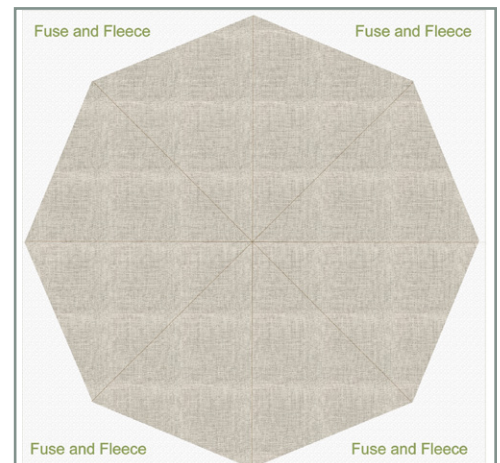

STEP 9

- Mark the center of the fabric with a cross-hair for placement of the center wreath design.
- Measure down each crease from the center crosshair 9" and mark a crosshair for the light string starting and ending points. The crosshair is where the designs will connect.

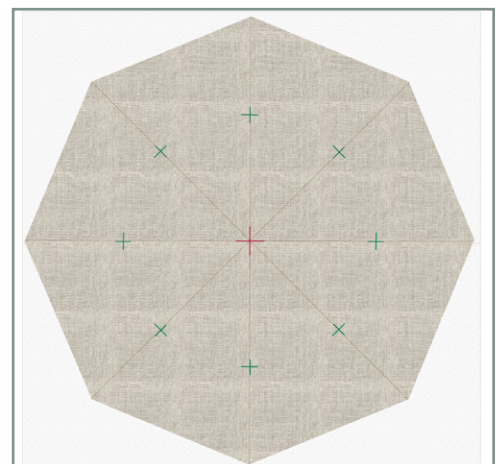

INSTRUCTIONS



STEP 10

- The image shows the placement of each design on the fabric with the marked crosshairs.

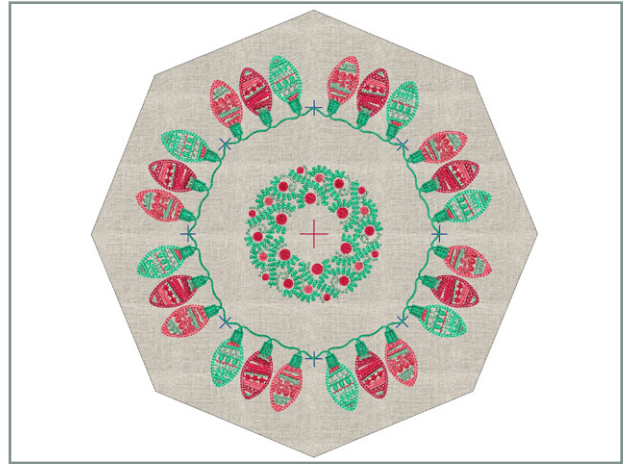

STEP 11

- Load the wreath design, 82023-25.
- Hoop the fabric with the center crosshair near the center of the hoop.
- Position the hoop so that the needle, when lowered, is in the center of the crosshair as shown.



STEP 12

- Cover the design area with topper and tape in place to hold.
- Stitch the design changing thread colors as required.
- When finished, remove the fabric from the hoop. Remove excess topping.



INSTRUCTIONS



STEP 13

- Load design 82023-13.
- If necessary, rotate the design to display as shown.
- Note – the following steps use the Pinpoint Placement feature of the Bernina Plus machines. If this feature is not available, skip to Addendum A.

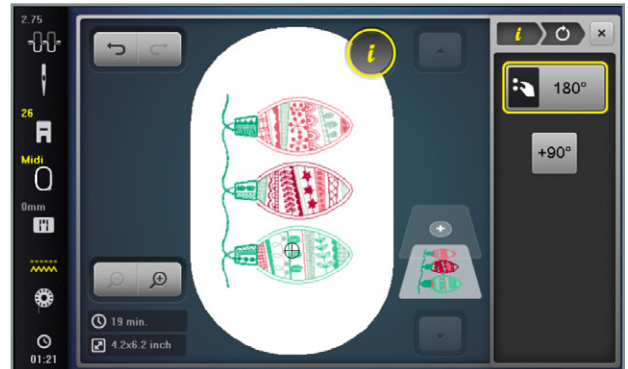

STEP 14

- Hoop the fabric to include two crosshairs close to the attachment side of the hoop as shown.
- Attach the hoop to the machine.



STEP 15

- In the information menu, select the Pinpoint Placement Icon.
- Select the Positioning Dots option.
- Touch the screen above the uppermost stitch of the design to designate the first positioning dot.
- Use the multi-function knobs to position top crosshair on the fabric directly under the needle. Drop the needle to check the accuracy. Adjust if necessary.
- Press the set button.

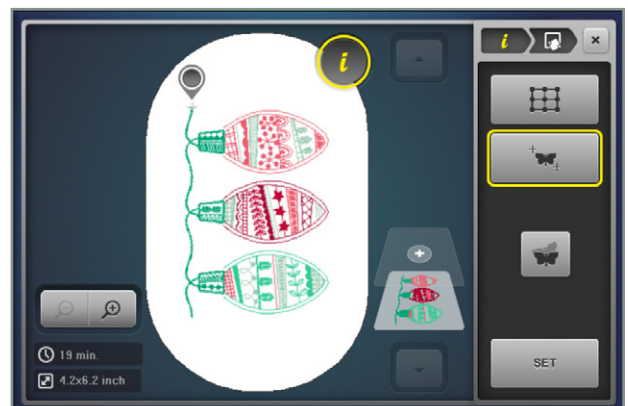

INSTRUCTIONS



STEP 16

- Touch the screen below the bottommost stitch of the design to designate the second positioning dot.
- Use the multi-function knobs to position bottom crosshair on the fabric directly under the needle. Drop the needle to check the accuracy. Adjust if necessary.
- Press the set button. Exit the Information Screen.
- Note – the Pinpoint Placement feature has resized the design to fit perfectly between the two crosshairs.

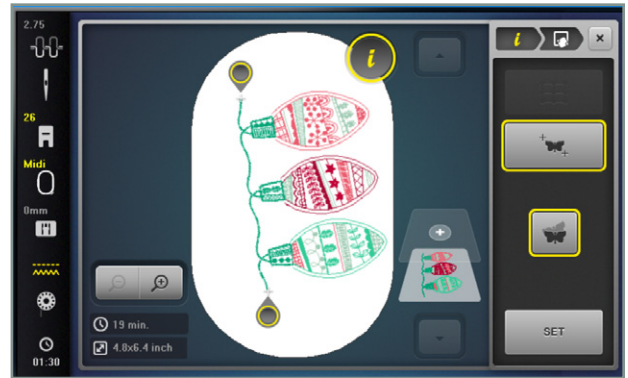

STEP 17

- Move from editing to stitching mode by touching the Needle Icon.
- Stitch the design changing colors as requested.
- When complete, remove the hoop from the machine and the fabric from the hoop.



STEP 18

- Repeat from Step 14 for the remaining designs with two exceptions.
- When connecting to the previous design, connect to the last stitch of the design instead of to the drawn crosshair as shown. This will ensure perfect, stitch-to-stitch alignment!
- On the last design, connect both points of the design to the stitches of the designs on either side.
- Want to save time? It is also possible to stitch two of the designs in one hooping with a Maxi, Mega or Jumbo hoop. Proceed to Addendum B.



INSTRUCTIONS



STEP 19

- Press the embroidered fabric and remove all topper and crosshair marks.
- Trim away the excess Fuse and Fleece along the edge of the fabric as shown



STEP 20

- Repeat Steps 2-7 for the backing fabric. Or, on a flat surface use the embroidered fabric as a pattern and trace around the edges onto the backing fabric. Trim away excess fabric.
- Fold the backing as described in step 2. (If it has already been trimmed, match the points of the octagon as it is folded.) Press folds to crease.
- Mark 1 1/2" from the center point on each crease. Cut point to point as shown. This creates an octagonal opening for the tree trunk.

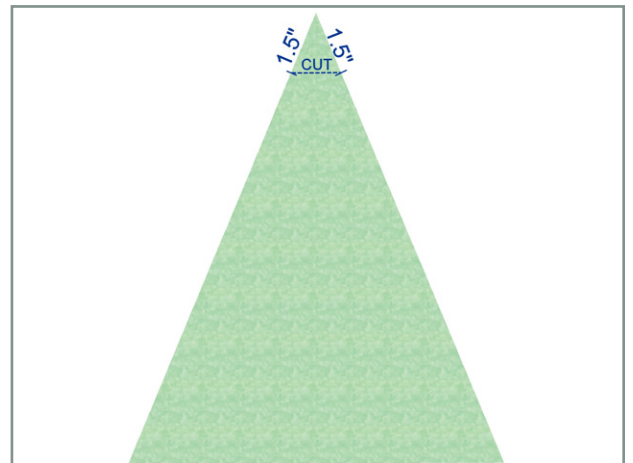

STEP 21

- Press the backing. Lay the backing over the tree skirt, right sides together.
- Pin outer edges and inner opening.

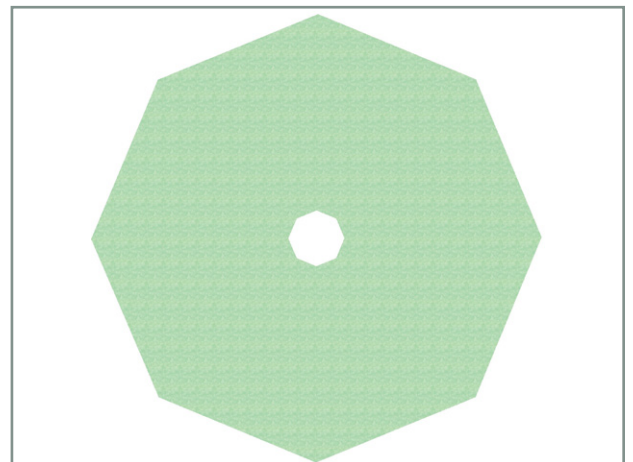

INSTRUCTIONS



STEP 22

- Stitch the inner opening using a $\frac{1}{4}$ " seam allowance.
- Stitch the outer edges with a $\frac{1}{4}$ " seam allowance.

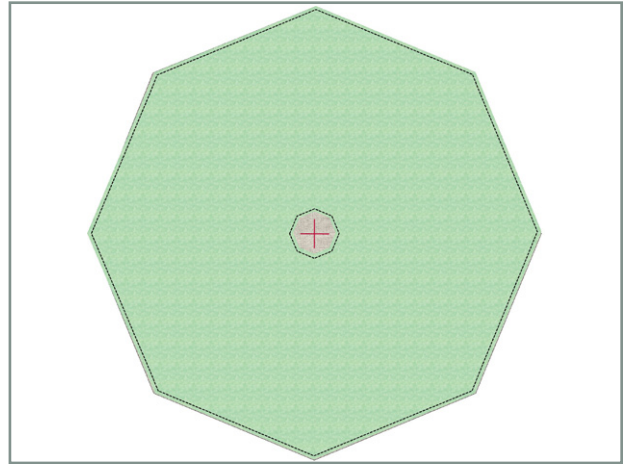

STEP 23

- On the wrong side of the skirt front, mark a line from the center of the skirt to the outer edge Using the junctions of the designs and the previously pressed creases as a guide.



STEP 24

- Stitch $\frac{1}{8}$ " away from the drawn line on one side.
- On the other side, stitch $\frac{1}{8}$ " away from the drawn line but leave a large opening for turning the skirt right side out. For best results, backstitch on each side of the opening.



INSTRUCTIONS



STEP 25

- Cut apart the tree skirt on the drawn line.
- Trim fabric in center to $\frac{1}{4}$ ". Clip into each inner corner. Trim each outer corner to remove bulk.
- Turn tree skirt right side out. Use the Expert Point and Press Tool to facilitate turning corners and points. Press.
- Press under seam allowance on both sides of the opening. Secure with hand stitching or fuse.
- Add ribbon or the closure of your choice to hold the opening together when used.



STEP A1

Addendum A: Instructions without Pinpoint Placement

- Increase the size of the design proportionally to 112° . Print a template of the design onto a StabilStick Template Sheet. Trim template.
- Position the template so the upper and lower ends meet at their crosshairs.



STEP A2

- Hoop the fabric with the template in place.



INSTRUCTIONS



STEP A3

- Use the template crosshair to position the hoop under the needle.
- Rotate if necessary.
- Remove the template! Stitch the design.
- Note – The template may be reused for each hooping.
- Repeat for all eight designs.
- Return to Step 19 for completion instructions.



STEP B1

Addendum B: Multiple Design Embroidery

- **Optional**
- Orient the design as shown in the image in Step 13.
- In the Information Menu, select Duplicate. Two designs are now displayed on the screen and the second one is selected.
- Select the Rotate Icon. Using the Multifunction knobs, rotate that design 45° as shown.
- Move the rotated design down to connect with the original design at its bottommost point. Use the zoom in feature to verify placement. Zoom back out.

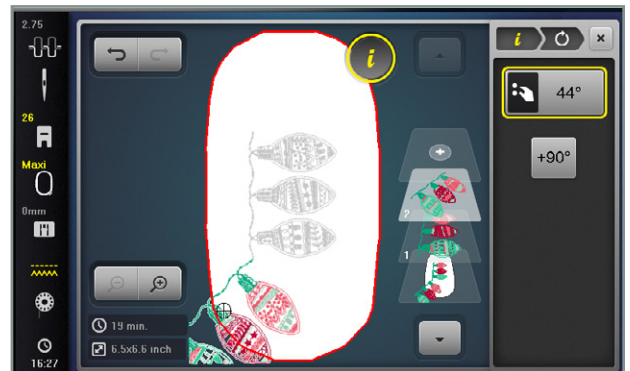

STEP B2

- Select both designs by clicking on the bottom layer.
- Select the Rotate icon. Rotate the design -22°.
- Move the rotated design back into the sewing area of the hoop as shown.

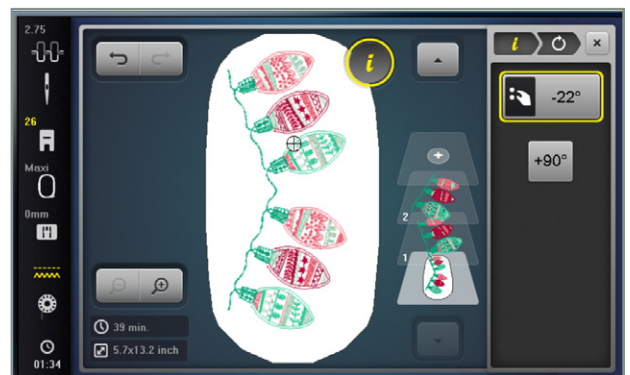

INSTRUCTIONS



STEP B3

- Exit the information menu and select the needle to move to stitching mode.
- To save time in thread changes, click on the Color Resequenece icon (highlighted) to combine colors

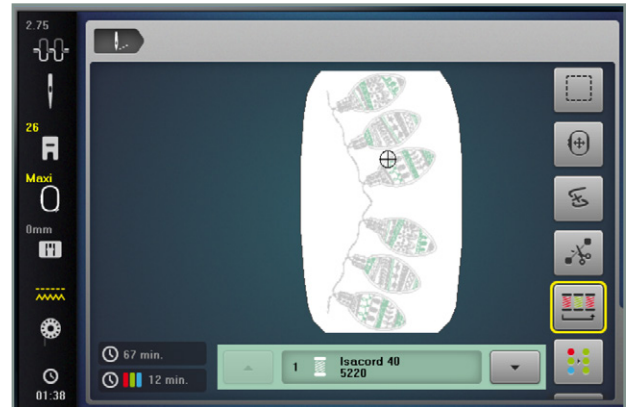

STEP B4

- When hooping the fabric, include three of the crosshairs as shown.
- When positioning the designs with Pinpoint Placement, still select the uppermost and bottommost points to align with their respective crosshairs.
- Return to Step 19 for completion Instructions.

